

**Project Report  
ATC-252**

# **The Marine Stratus Initiative at San Francisco International Airport**

**D. A. Clark  
F. W. Wilson**

**25 June 1996**

---

**Lincoln Laboratory**  
MASSACHUSETTS INSTITUTE OF TECHNOLOGY  
*LEXINGTON, MASSACHUSETTS*

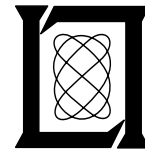

Prepared for the Federal Aviation Administration,  
Washington, D.C. 20591

This document is available to the public through  
the National Technical Information Service,  
Springfield, VA 22161

This document is disseminated under the sponsorship of the Department of Transportation in the interest of information exchange. The United States Government assumes no liability for its contents or use thereof.

|   |  |  |  |   |           |
|---|--|--|--|---|-----------|
| 1. Report No.<br>ATC-252  |  | 2. Government Accession No.                              |  | 3. Recipient's Catalog No.  |           |
| 4. Title and Subtitle<br><br>The Marine Stratus Initiative at San Francisco International Airport   |  |  |  | 5. Report Date<br>25 June 1996  |           |
|   |  |  |  | 6. Performing Organization Code   |           |
| 7. Author(s)<br>David A. Clark and F. Wesley Wilson   |  |  |  | 8. Performing Organization Report No.<br>ATC-252  |           |
| 9. Performing Organization Name and Address<br><br>MIT Lincoln Laboratory<br>244 Wood Street<br>Lexington, MA 02173-9108  |  |  |  | 10. Work Unit No. (TRAVIS)  |           |
|   |  |  |  | 11. Contract or Grant No.<br>DTFA01-91-Z-02036  |           |
| 12. Sponsoring Agency Name and Address<br><br>Department of Transportation<br>Federal Aviation Administration<br>Washington, DC 20591   |  |  |  | 13. Type of Report and Period Covered<br><br>Project Report   |           |
|   |  |  |  | 14. Sponsoring Agency Code  |           |
| 15. Supplementary Notes<br><br>This report is based on studies performed at Lincoln Laboratory, a center for research operated by Massachusetts Institute of Technology, under Air Force Contract F19628-95-C-0002.   |  |  |  |   |           |
| 16. Abstract<br><br>San Francisco International Airport is one of the busiest airports in the United States and one of the highest delay airports in terms of total aircraft delay hours and number of imposed air traffic delay programs. As with most airports, weather is the primary cause of aircraft delay. In particular, the local airspace is prone to regular occurrences of low cloud ceiling conditions due to intrusion of marine air from the eastern Pacific Ocean from May through September. Typically, this layer of stratus clouds forms in the San Francisco Bay area overnight and dissipates during the middle to late morning. The timing of the stratus cloud dissipation is such that it frequently poses a threat to the morning arrival push of air traffic into San Francisco. Weather forecasters at the Central Weather Service Unit (CWSU) at the Oakland Air Route Traffic Control Center are responsible for providing a forecast of whether or not the cloudiness will impact morning traffic operations. This information is used for decision making by the Traffic Management Unit at Oakland Center in order to optimally match arriving traffic demand to available airport capacity.<br>As part of the FAA's Integrated Terminal Weather System, the Weather Sensing Group at MIT Lincoln Laboratory has begun an effort entitled the "Marine Stratus Initiative." Its objective is to provide improved weather information and forecast guidance to the Oakland CWSU, which is responsible for providing weather forecasts to air traffic managers. During 1995, the main focus of the project was the design and implementation of a data acquisition, communication, and display infrastructure that provides forecasters with new sources of weather data and information. These initial capabilities were tested during an operational demonstration in August and September. As the project continues, the intent is to improve these new data sources and develop an automated or semi-automated algorithm that will process raw information to provide weather forecasters with numerical guidance to assist them in the forecast process.<br>A description of airport operations at San Francisco and the impact of marine stratus are presented. An explanation is given of the marine stratus phenomenology and the primary factors contributing to cloud dissipation. This conceptual model of the dissipation process is used to define system requirements. A description of the hardware, communications, and display subsystems is provided. An overview of the 1995 demonstration, including user comments, is presented, as well as future plans for meeting the longer-term objectives of the project. |  |  |  |   |           |
| 17. Key Words<br>San Francisco marine stratus cloud ceiling burn-off airport capacity<br>Traffic Management Unit aircraft delay Integrated Terminal Weather System (ITWS) Central Weather Service Unit  |  |  |  | 18. Distribution Statement<br><br>This document is available to the public through the National Technical Information Service, Springfield, VA 22161. |           |
| 19. Security Classif. (of this report)<br><br>Unclassified  |  | 20. Security Classif. (of this page)<br><br>Unclassified |  | 21. No. of Pages<br><br>54  | 22. Price |

## ACKNOWLEDGMENTS

We thank the project team members at Lincoln Laboratory who were critical to the initial development and demonstration of the system. Rob DeMillo and Rick Grubin were responsible for the initial design and implementation of the data management and display systems. Sue Yao was instrumental in upgrading and maintaining the real-time system, leading to a successful demonstration. We also thank Chris Smith for his devoted efforts toward improving and maintaining the display software and for his contribution to this report. Thanks also to Duane Grant for his assistance with computer hardware and communications, and thanks to Leslie Mahn for her assistance in preparing this document.

We also appreciate the cooperative efforts from the many organizations participating in the project. In particular, a special thanks to Doug Sinton, William Chan, and John Farley at San Jose State University, Walt Strach at the Oakland CWSU, Carl Knable and Steve Gregory at United Airlines, Dave Reynolds at the NWS Forecast Office in Monterey, Gene Shelar at Pacific Gas & Electric, and Dick Duker of the Bay Area Air Quality Management District. Thanks also to Paul Candelarie for the cooperation and assistance of SFO Airport Facilities.

# TABLE OF CONTENTS

|   |     |
|---|-----|
| Acknowledgments   | iii |
| List of Illustrations   | vii |
| List of Tables  | ix  |
| 1. THE IMPACT OF WEATHER ON OPERATIONS                                | 1   |
| 1.1 Introduction  | 1   |
| 1.2 Air Traffic Operations  | 1   |
| 1.3 Benefits of Improved Forecasts                                    | 4   |
| 2. MARINE STRATUS PHENOMENOLOGY                                       | 5   |
| 2.1 The Daily Marine Stratus Cycle                                    | 5   |
| 2.2 Physical Mechanisms Contributing to the Cloud Dissipation Process | 6   |
| 2.3 Summary of Physical Processes and Assumptions                     | 11  |
| 3. SYSTEM REQUIREMENTS  | 13  |
| 3.1 Objectives  | 13  |
| 3.2 Meteorological Information Requirements                           | 13  |
| 3.3 Sensors and Data  | 14  |
| 4. SYSTEM DESCRIPTION   | 19  |
| 4.1 System Design   | 19  |
| 4.2 1995 System Implementation  | 21  |
| 5. DISPLAY PRODUCTS   | 25  |
| 5.1 Display Design  | 25  |
| 5.2 Display Control   | 25  |
| 5.3 Display Product Descriptions                                      | 26  |
| 6. OVERVIEW OF 1995 DEMONSTRATION                                     | 31  |
| 6.1 CWSU Operating Procedures   | 31  |
| 6.2 Initial Operational Demonstration                                 | 31  |
| 6.3 System Performance  | 31  |
| 6.4 User Comments and Product Effectiveness                           | 32  |

## **TABLE OF CONTENTS (Continued)**

|     |                                       |    |
|-----|---------------------------------------|----|
| 7.  | PLANS FOR 1996 AND BEYOND             | 35 |
| 7.1 | Objectives                            | 35 |
| 7.2 | Column Model Implementation           | 35 |
| 7.3 | Sensors                               | 36 |
| 7.4 | Data Management                       | 37 |
| 7.5 | Displays                              | 37 |
| 7.6 | Automated Numerical Forecast Guidance | 37 |
|     | ACRONYMS AND ABBREVIATIONS            | 39 |
|     | REFERENCES                            | 41 |

## LIST OF ILLUSTRATIONS

| Figure No. |   | Page |
|------------|---|------|
| 1          | San Francisco Bay area and SFO approach zone.   | 2    |
| 2          | Hourly arrival demand at SFO.   | 3    |
| 3          | Diurnal distribution of frequency of transition from Visual Flight Rules (VFR) to Instrument Flight Rules (IFR) at SFO, and vice versa, from May through September. | 3    |
| 4          | Hourly traffic count showing actual hourly arrivals (black) on 4 August 95, and adjusted hourly arrival assuming optimal use of available capacity (grey).          | 4    |
| 5          | Prevailing summertime pressure pattern in eastern Pacific.  | 5    |
| 6          | The daily marine stratus cycle.   | 7    |
| 7          | Conservation of total water content (liquid plus vapor) during cloud evaporation process.   | 8    |
| 8          | Observed [4] and conceptual model of vertical distribution of liquid water density in marine stratus cloud.   | 8    |
| 9          | Important radiation processes relevant to cloud dissipation model.  | 9    |
| 10         | Oakland rawinsonde soundings for 1200 UTC on 31 August 95 and 1 September 95.   | 10   |
| 11         | Location of data sources in the San Francisco Bay area.   | 16   |
| 12         | Upwardly directly parabolic reflector, similar to that employed by acoustic sounder. Acoustic sounder.  | 17   |
| 13         | SFO Marine Stratus Initiative data flow diagram.  | 20   |
| 14         | Initial 1995 system implementation.   | 22   |
| 15         | Current system configuration.   | 23   |
| 16         | General display function architecture.  | 25   |
| 17         | Display control menu bar, with pull-down menu exposed for Controls selection button.  | 26   |
| 18         | Displays of surface weather observations from SFO ASOS.   | 27   |
| 19         | Vertical profile time-series displays from arrival aircraft reports, departure aircraft reports, and Doppler SODAR.   | 29   |
| 20         | Displays of inversion base height time series, from acoustic sounders at SFO and Dumbarton Bridge.  | 30   |
| 21         | System support provided by San Jose State University and MIT Lincoln Laboratory during CWSU operating hours.  | 32   |
| 22         | Functional flow diagram of end-state system.  | 36   |

## LIST OF TABLES

| <b>Table</b> |   | <b>Page</b> |
|--------------|---|-------------|
| 1            | Data Sources for the 1995 Operational Demonstration | 15          |



# 1. THE IMPACT OF WEATHER ON OPERATIONS

## 1.1. Introduction

San Francisco International Airport (SFO) is the fifth busiest airport in the United States in terms of passenger enplanements (approximately 15 million) and twelfth busiest in terms of total operations (approximately 425,000) per year [1]. It is a major hub for United Airlines and is a key staging airport for international flights. As a result, air traffic flow restrictions into and out of SFO have major consequences in terms of airline delay time, missed connections, controller workload, and downstream disruptions of air traffic flow throughout the entire national airspace system.

Adverse weather is responsible for most airline delay and traffic flow disruption in the United States. SFO is one of the highest delay airports in the country in terms of airline delay hours and imposed delay programs. Low cloud and fog are by far the major contributors to this delay. In particular, the local airspace is prone to regular occurrences of low ceiling conditions due to intrusion of marine stratus cloud, which is present along the Pacific coast much of the time from May through September. Typically, the stratus cloud forms in the San Francisco Bay area overnight and dissipates during the middle to late morning. Since the morning arrival push of traffic coincides with this typical cloud “burn-off” time, traffic managers at the Oakland Air Route Traffic Control Center (ARTCC) face a continual challenge of trying to anticipate the available airport capacity that will be permissible by the weather conditions during the morning arrival peak period. A similar (though less frequent) problem exists in the evening when the onset of clouds can interfere with the final arrival peak of the day.

As part of the FAA’s Integrated Terminal Weather System (ITWS), the Weather Sensing Group at MIT Lincoln Laboratory has begun an effort entitled the “San Francisco Marine Stratus Initiative.” Its objective is to generate improved airport capacity forecasts for decision making by the Traffic Management Unit (TMU). This is achieved by providing improved weather information and forecast guidance to assist forecasters at the Oakland Central Weather Service Unit (CWSU) who are responsible for providing weather forecasts to air traffic managers. The effort has been a collaborative one, gaining leverage from the resources and interests of several groups, including the FAA (including Oakland Center), San Jose State University (SJSU), the National Weather Service Office at Monterey, United Airlines, Pacific Gas & Electric, and the Bay Area Air Quality Management District.

During 1995, the main focus of the Marine Stratus Initiative has been design and implementation of a data acquisition, communication, and display infrastructure that provides CWSU forecasters with new sources of weather data and information. These initial capabilities were tested during an operational demonstration in August and September. As the project continues, the intent is to improve these new data sources and develop automated or semi-automated models and algorithms that will process raw information and provide weather forecasters and TMU personnel with numerical forecast guidance to assist them in their decision-making process.

## 1.2. Air Traffic Operations

San Francisco International Airport (SFO) is situated on the western shore of San Francisco Bay in the San Joaquin Valley of California (see Figure 1). The airport has two pairs of very closely spaced (~750 feet) parallel runways. The normal runway configuration is to land aircraft to the west-

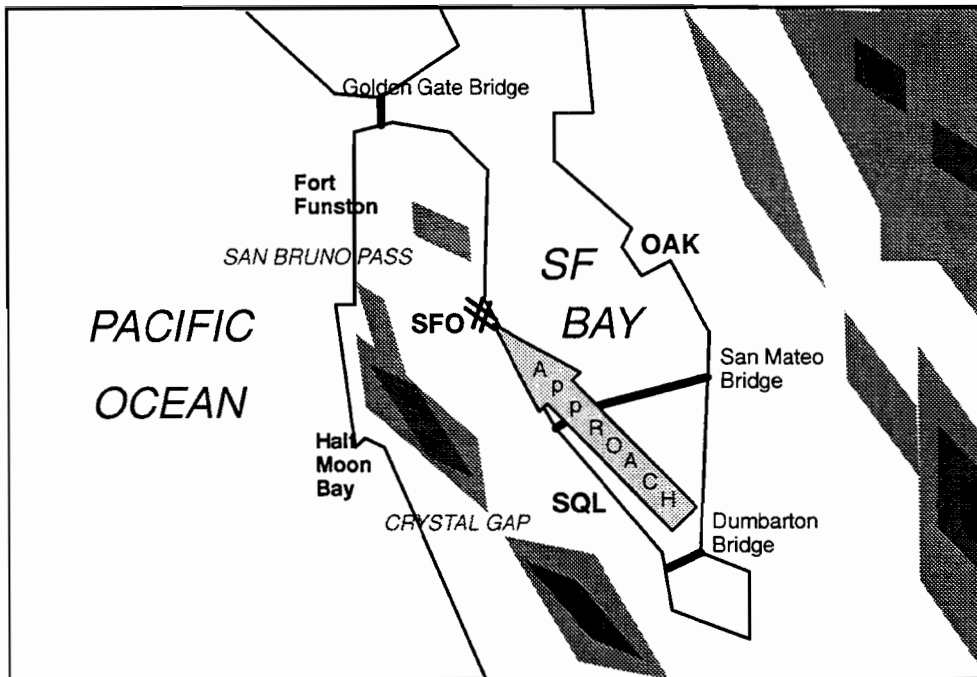

Figure 1. San Francisco Bay area and SFO approach zone.

northwest on runways 28L and 28R, while running departures to the north-northwest on 01L and 01R. The airport is part of the Bay Area TRACON, so arriving and departing traffic must be coordinated with operations at Oakland International Airport and San Jose International Airport.

Aircraft arriving at SFO from all directions are merged together in the approach zone approximately 5–15 miles to the east-southeast of the airport. Because of the mountainous terrain to the east and west, this merger occurs at an altitude of approximately 3500 feet. Under Visual Flight Rules (VFR) conditions, aircraft are allowed to merge in pairs and make simultaneous parallel approaches on Runways 28L and 28R. Under these conditions, the airport operates at an optimal arrival rate capacity of approximately 50–55 planes per hour. When aircraft are not able to see one another in this merger zone due to visual obstruction (cloud, haze, precipitation), the approaching aircraft must be staggered, reducing the arrival capacity to 30–35 planes per hour.

Examination of the typical weekday demand for arrivals (Figure 2) illustrates the impact of capacity loss when the airport is not able to perform visual, dual-parallel approaches. The morning arrival push begins shortly after 10:00 AM local time, at which time the demand rises to nearly 50 planes per hour, continuing at this rate until after 12:30 PM. When dual-parallel approaches are not possible during this period, the deficit of scheduled arrival aircraft that cannot be handled accumulates at a rate of about 15 planes per hour.

The Traffic Management Unit (TMU) at Oakland Center is responsible for decisions regarding the flow of traffic into and out of SFO. They communicate with the national Air Traffic Control System Command Center in order to regulate the flow of traffic into the airport, based on anticipated available capacity. When capacity is restricted by weather, aircraft delay “programs” are imposed in order to regulate the flow of traffic into SFO. These programs are primarily implemented as ground holds at upstream airports. In practice, the majority of ground delays are imposed upon flights originating at airports that are less than two hours flight time from SFO. The decision to can-

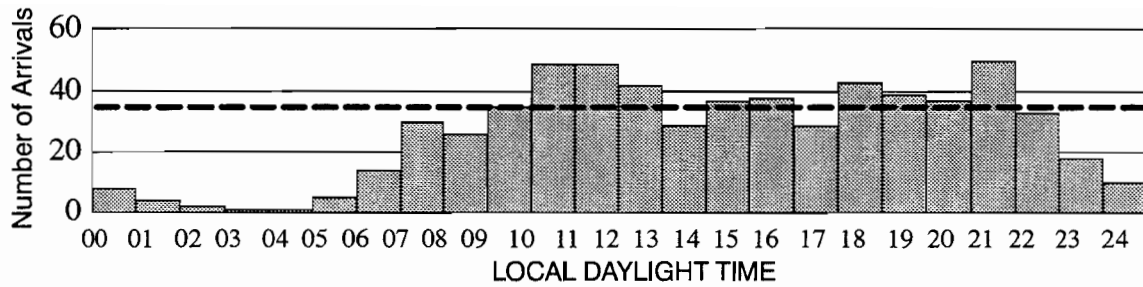

Figure 2. Hourly arrival demand at SFO. Dashed line indicates airport capacity during low ceiling conditions.

cel an imposed delay program is based on anticipated improvement to local capacity. The tradeoff is between excessive upstream gate holds at originating airports if weather improves earlier than expected and unacceptable levels of local airborne holding traffic and diversions in the event that restricted capacity continues longer than anticipated. Thus, the TMU objective is to optimally match arrival demand with available capacity so as to minimize upstream gate hold delay without overburdening local controllers with an unacceptable amount of incoming traffic.

The Central Weather Service Unit (CWSU) at Oakland Center is responsible for providing the TMU with an estimate of when weather conditions are expected to improve or deteriorate so as to affect the available airport operating capacity. The primary weather problem at San Francisco International Airport is low cloud ceiling conditions from intrusion of stratus clouds in the Bay area. During the summer stratus season (May through September), their primary focus is on anticipating the morning cloud burn-off time relative to the morning arrival peak and the onset of clouds in the evening relative to the evening arrival peak. The operational importance of these forecasts becomes particularly apparent when considered in context of the climatological likelihood of cloud onset and dissipation relative to scheduled aircraft arrival demand. Figure 3 shows the diurnal distribution of transitions between Visual Flight Rules (VFR) conditions and Instrument Flight Rules (IFR) conditions at SFO from May through September. The transition from VFR to IFR represents an onset of clouds at the airport, while an IFR transition to VFR represents cloud dissipation. The onset (VFR to IFR) almost always occurs between sunset and sunrise, with a preferred frequency of 1:00 AM to 6:00 AM. Occasionally, the onset will occur early enough (prior to 8:00 PM) to impact the evening arrival rush. More important is the expected time of cloud dissipation (IFR to VFR); the typical range is from 8:00 AM to 1:00 PM, with the highest likelihood near 10:00 AM. This coincides with the start of the morning arrival traffic rush described earlier. This emphasizes the importance of the cloud forecast in the operational decision of whether or not to make an adjustment to the flow rate of arriving traffic.

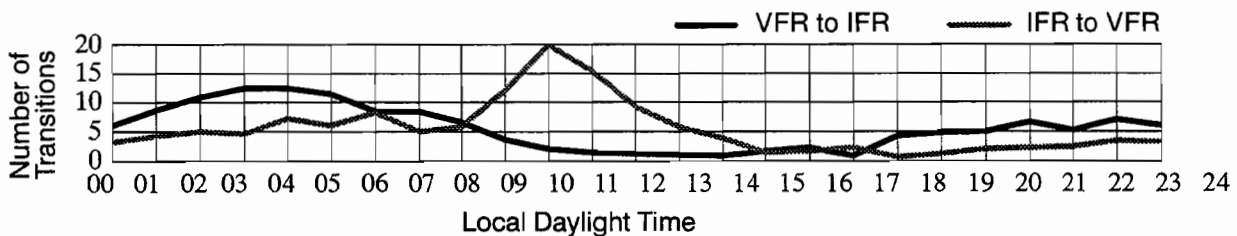

Figure 3. Diurnal distribution of frequency of transition from Visual Flight Rules (VFR) to Instrument Flight Rules (IFR) at SFO, and vice versa, from May through September. IFR conditions are defined as presence of cloud ceiling height of less than 2000 feet.

### 1.3. Benefits of Improved Forecasts

San Francisco International Airport is one of the leading U.S. airports in terms of aircraft delay hours and number of managed delay programs. With total delays well in excess of 20,000 hours annually [1], airline and passenger costs at San Francisco may approach \$100 million annually. With such a high annual cost, a modest reduction in delay time (on the order of a few percent) would result in a substantial cost savings.

The primary expected benefit of improvements to forecasts of cloud burn-off (and onset) times at San Francisco is a better matching of aircraft arrival demand to available airport capacity. Studies using parametric queuing models have indicated that optimal matching of demand to capacity could potentially reduce total delay hours for flights into San Francisco by as much as 25 percent on days when low cloudiness threatens to interfere with the morning arrival rush [2]. (An example of this type of model delay reduction is shown in Figure 4). This translates to an average of approximately 30 aircraft-hours of achievable delay reduction into SFO on approximately 40–50 days per year during May through September. Thus, even a partial effectiveness in reducing this recoverable delay could result in an associated delay cost savings of a few million dollars per year. Improvements to forecast of onset times, as well as collateral improvements to forecasts of non-stratus weather, would also add to this delay reduction benefit. Reducing overall delay costs by improved matching of operational demand to available capacity is the primary motivation of the Marine Stratus Initiative.

Beyond reduction of delay into SFO, there are other collateral benefits that are more difficult to quantify. Among these are the reduced controller workload/stress associated with better matching of capacity to demand. Other benefits to airlines would include improved planning for flight crew scheduling, hubbing operations, fuel-load planning, and a reduction in flight cancellations, diversions, and missed connections.

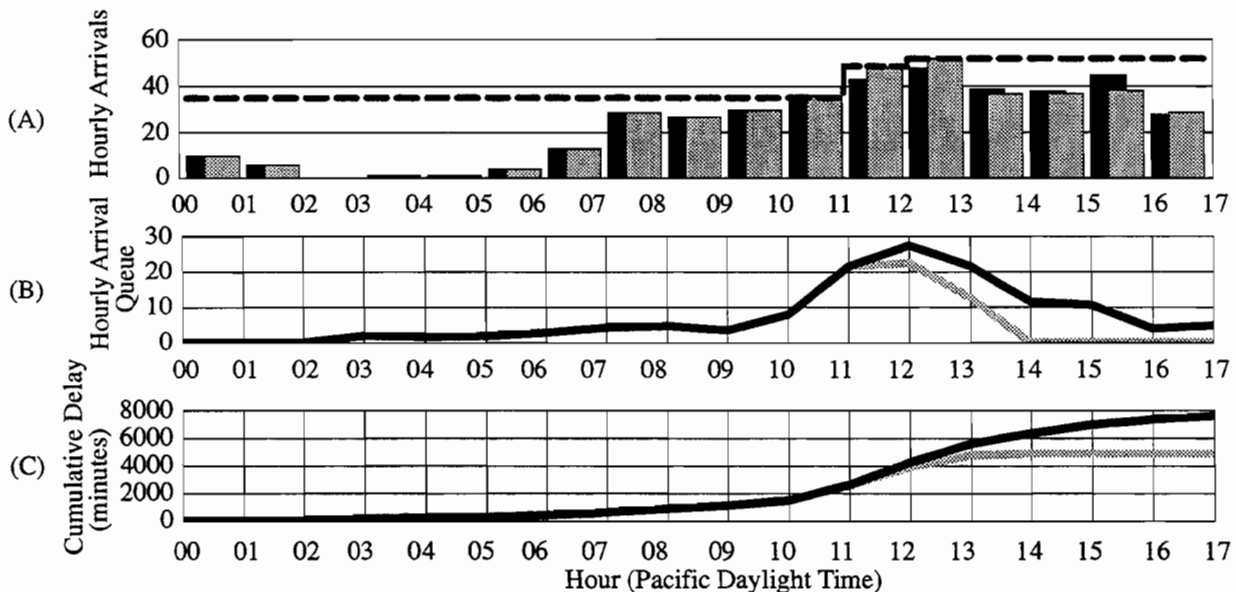

Figure 4. A) Hourly traffic count showing actual hourly arrivals (black) on 4 August 95, and adjusted hourly arrival assuming optimal use of available capacity (grey). Dashed line indicates optimal available capacity. B) Hourly arrival queue (number of planes) from model using actual (black) and adjusted hourly arrival counts. C) Hourly cumulative delay (minutes) from queuing model using actual (black) and adjusted (grey) hourly arrival counts.

## 2. MARINE STRATUS PHENOMENOLOGY

### 2.1. The Daily Marine Stratus Cycle

The weather conditions at a specific location are affected by atmospheric motions occurring over a variety of spatial and temporal scales. Large- (synoptic) scale motions have spatial scales on the order of hundreds of kilometers, and vary slowly, on the order of days. Regional scale motions, such as those associated with the daily heating cycle, have spatial scales of tens of kilometers and temporal scales of about a day. Local small-scale motions, such as eddy motions, are those with spatial scales on the order of a few kilometers, with time scales on the order of minutes to hours. Understanding changes in the weather conditions at a specific location, therefore, requires an understanding of the extent to which the atmospheric forcing on each of these scales is contributing toward influencing local conditions.

From late spring through summer, the large scale wind circulation in the northeastern Pacific Ocean is typically controlled by a high pressure area which creates a northerly (southward) flow of air along the west coast of central North America (Figure 5). The result is a large scale subsidence (descent and warming) of air along the western U.S. coastal region. This persistent flow along the coast also causes upwelling, or rising of cold water, in the eastern Pacific. This cooling produces marine fog off-shore of the western U.S. coast that is capped above by the warm air subsidence. The capping occurs at the base of the vertical temperature inversion, or the transition from the cool marine air below to the warm air above. This cool, moist layer below the inversion is referred to as the "marine boundary layer." Thus, a variation in the large scale pressure field and its associated vertical motions greatly influence the depth of the marine layer. Typically, the depth of this layer will vary slowly over several days. The approach of a sharp synoptic scale feature (such as a frontal boundary or pressure trough) can result in a more rapid change in the marine layer depth. In addition to influencing the depth in the marine layer, the larger scale pressure field also has an influence on the likelihood that this marine air will encroach on the adjacent U.S. continental land mass. The prevailing synoptic scale pressure field along the western U.S. coast has a somewhat favorable influence toward an onshore movement of the marine air; however, the large scale pressure field variability can allow a stronger onshore flow (increasing the likelihood of marine air intrusion), or offshore flow (preventing the advancement of marine air onto the land mass).

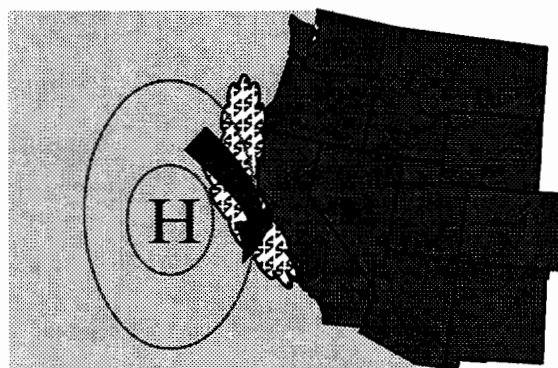

*Figure 5. Prevailing summertime pressure pattern in eastern Pacific. High pressure results in northerly wind along western U.S. coastline, and marine fog in eastern Pacific Ocean.*

During the late spring and summer months (May through September), the regional scale circulation in the San Francisco Bay area is affected by horizontal variations in surface heating. Day-time heating in the interior California valleys creates a large land–sea temperature contrast that results in a seabreeze (onshore) circulation. When the larger scale pressure gradient forcing is not strong enough to inhibit onshore flow, the regional thermal circulation draws the cool, moist air marine air inland. The influx of cooler air into the bay causes a lowering of air temperature. After sunset, additional cooling via radiation brings the air to saturation temperature, and the water vapor begins to condense to form the stratus cloud. The base of the cloud deck typically ranges from 700 feet to 1500 feet, with tops of 1000–2500 feet, depending on the height of the inversion base

In the San Francisco Bay area, the movement of marine air is greatly influenced by the local topography (refer back to Figure 1). The Santa Cruz Mountains run from the west of San Francisco southward along the California coastline, ranging in height from approximately 1000 to 1900 feet. These mountains can act as a barrier for blocking the intrusion of marine air into the Bay area when the inversion base height is low (less than 1500 feet). There are two primary gaps in this mountain range, however, which can allow intrusion of the marine air. The more important of these is the San Bruno gap, approximately five miles to the northwest of SFO, where the elevation drops to 150 feet. The other is Crystal Springs Gap, which lies approximately seven miles to the south–southwest of the airport, where the elevation drops to 850 feet. As the top of the marine layer increases in height, the effectiveness of the coastal mountains in “damming” the marine air offshore is diminished. Once the marine air has moved into the San Francisco Bay area, the coastal range to the west of the bay and the Diablo Range to the east act as a dam or “bowl” to keep the moist air contained in the bay area. With radiational cooling after sunset, the visible cloudiness typically appears first in the north-east portion of the Bay (Oakland area) and fills the rest of the Bay (including SFO) by 1:00–2:00 AM local time. In the worst–case scenario relative to airport operations, the intrusion of a deep layer of marine air will provide sufficient cooling for onset of cloudiness at the airport and along the approach zone prior to 8:00 PM local time, thus impacting the evening rush of arriving air traffic.

The complete daily marine stratus cycle is depicted schematically in Figure 6. The figure shows a cross section of the bay area. Represented from left to right (west to east) are the Pacific Ocean, the coastal range, the San Joaquin Valley (including the San Francisco Bay), and the higher inland mountains as the western boundary of the large interior valley. Figure 6A shows the cycle beginning at mid–day with the offshore marine fog. The downward vertical arrows indicate the large scale subsidence creating the capping inversion separating cool, moist air below from warm dry air above. The horizontal arrow along the coast represents some modest onshore geostrophic flow, also resulting from large scale forcing. The larger vertical arrow represents rising warm air generated by the heating of the interior valley. By late afternoon (Figure 6), the seabreeze circulation caused by the horizontal differential heating begins to draw in the cooler marine air. The influx of cooler marine air accompanied by radiational cooling after sunset results in the deck of stratus cloud covering the bay area by early morning (Figure 6C). Warming of the air in the bay area after sunrise, primarily by solar insolation, works to evaporate the inland cloud throughout the morning hours (Figure 6D).

## **2.2. Physical Mechanisms Contributing to the Cloud Dissipation Process**

The initial focus of the Marine Stratus Initiative is to provide improved weather information for forecasting the dissipation of stratus cloud which may impact the morning arrival rush. There are a number of physical processes involved with cloud dissipation, and the interactions between processes are many and complex. In order to define system requirements, we consider a simplified

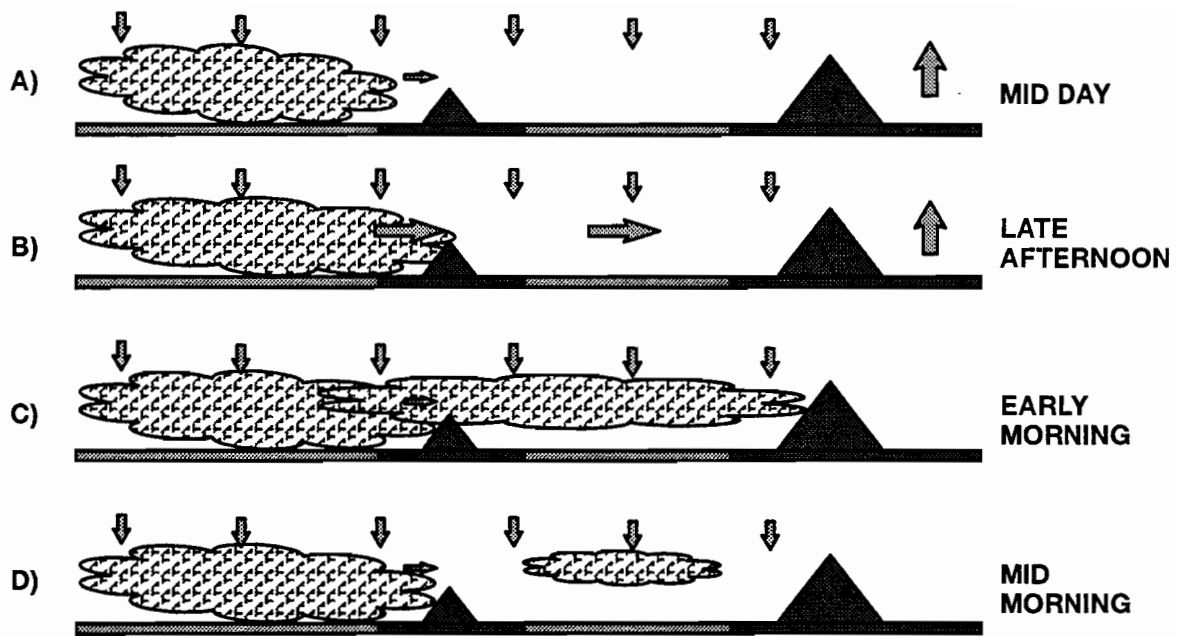

Figure 6. The daily marine stratus cycle.

conceptual model that captures the physical characteristics of marine stratus cloud and the important processes involved with its dissipation. This conceptual model is used as a baseline for identifying data collection requirements, both for providing new information to forecasters and for investigating a numerical model of the marine layer which handles the heat and moisture budgets associated with cloud dissipation. The important cloud characteristics and physical processes are described in the following paragraphs.

### 2.2.1. Cloud Layer Characteristics

The first step in developing a conceptual cloud dissipation model is to understand some important characteristics of the cloud layer itself. The model starts with an early morning cloud deck covering the Bay area (as depicted in Figure 6C), with a typical base of 700–1500 feet and a top of 1000–2500 feet. An important assumption affecting the cloud burn-off process is that the total water content in the marine layer (that is, the sum of water vapor plus liquid water droplets) remains reasonably constant throughout the burn-off process. Although the water vapor contributes more than 95 percent to the mass of the total water content, it is the liquid water droplets which define the visible cloud. The assumption of conservation of total water throughout the cloud burn-off process is evidenced by the nearly constant dew point temperature in the Bay area throughout the morning hours, since dew point temperature is an absolute measure of water vapor content (which represents nearly all of the total water mass). The other implicit assumption is that all of the condensed water is in the form of cloud liquid water droplets and not precipitation (or surface dew). This assumption is reasonable considering that San Francisco averages only one tenth of an inch of rain from June through August, and about one half of an inch of rain through the entire five-month stratus season of May through September. Based on these simplifications, the burn-off process is viewed as a phase change (evaporation) from liquid water to water vapor (Figure 7).

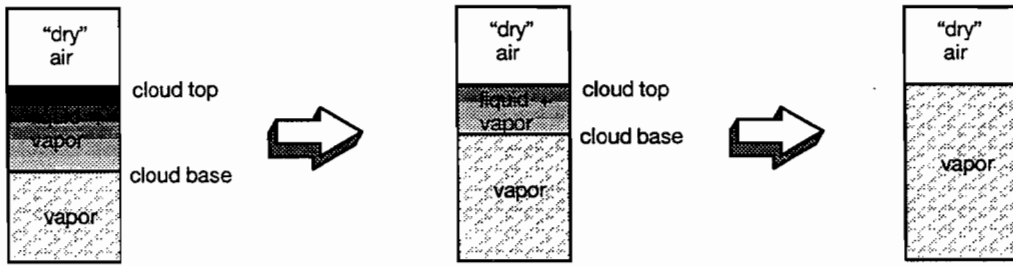

Figure 7. Conservation of total water content (liquid plus vapor) during cloud evaporation process.

Another important assumption regarding the cloud itself is that the density of liquid water within the cloud increases linearly from zero at the base of the cloud to a maximum density at the top of the cloud. This has been observed in numerous field experiments of stratus cloud along the California coastline [3],[4](see Figure 8A). The total liquid water content within the cloud can be viewed schematically as the area of the triangle shown in Figure 8B. In this simplified model, the cloud depth  $D$  is defined in terms of the cloud base and cloud top heights. Since the liquid water increases linearly with height at some known rate (i.e., constant slope of triangle hypotenuse), then the liquid water content at the top of the cloud ( $L_{max}$ ) can also be determined from the cloud base and cloud top heights. And since the liquid water can be defined geometrically as  $L_{total} = 1/2 DL_{max}$ , an important consequence of this concept is that the total liquid water content of the cloud varies quadratically with the depth of the cloud.

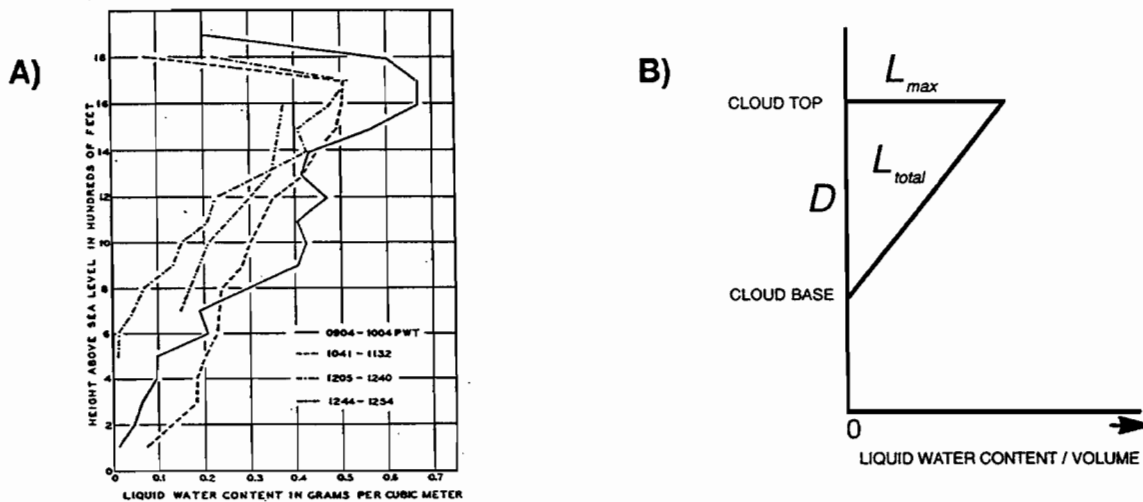

Figure 8. A) Observed [4] and B) conceptual model of vertical distribution of liquid water density in marine stratus cloud.

In summary, our conceptual model of cloud characteristics describes the cloud dissipation process as conversion of cloud liquid water to water vapor (i.e., evaporation), where the amount of liquid water to be evaporated is defined by cloud base height and cloud top height. In simplest terms, the cloud burn-off occurs when cloud base height equals cloud top height. Important processes are those which contribute toward a change in cloud base height or cloud top height.



### 2.2.2. Radiation Processes

In our conceptual model of the cloud burn-off process, we consider a layer (or one-dimensional column) of air where the top of the cloud is determined by the inversion base height, and the base of the cloud is determined by the Lifting Condensation Level (LCL). The LCL is defined as the altitude at which water vapor in a lifted parcel of air (cooled adiabatically in the lifting process) condenses. For a given surface air pressure, the LCL can be directly determined from the surface dew point depression (i.e., the difference between the temperature and the dew point temperature). An important characteristic of the marine layer is that it is “well-mixed”; that is, there is sufficient turbulent kinetic energy to relatively quickly distribute heat vertically through the entire layer of marine air above the ground. This implies that incoming energy at the base of the marine layer (e.g., from surface heating) is used to uniformly raise the equivalent potential temperature of the entire layer. (The equivalent potential temperature is a measurement that accounts for water content in the air and for temperature changes resulting from adiabatic processes.) Conceptually, the burn-off process can be described as warming the marine layer sufficiently to raise the LCL height (cloud base) to the inversion base height (cloud top).

The primary source of marine layer heating is solar insolation. After sunrise, a portion of the short-wave solar radiation passes through the cloud deck and is absorbed by the earth’s surface (see Figure 9). The ground is heated, and it emits energy as long-wave radiation. This flux of heat from the ground is distributed vertically, thus raising the temperature of the layer (or column) of air above the ground. As the air is heated and the LCL is raised, the visible cloud evaporates from the cloud base upward. Although most of the energy is being used to warm the marine layer, some of the energy is expended as latent heat of evaporation of the cloud. Cloud burn-off occurs when enough transmitted solar energy is introduced into the marine layer to sufficiently heat the layer and evaporate all of the liquid water in the cloud to water vapor.

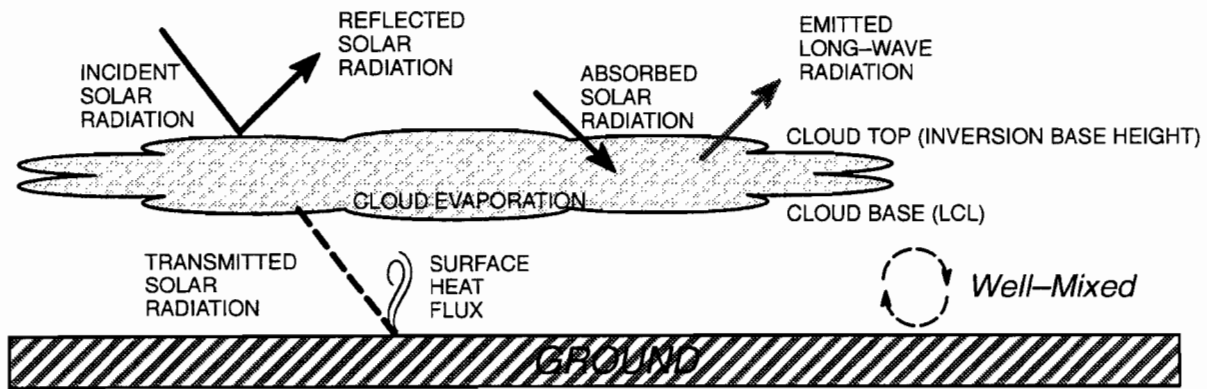

Figure 9. Important radiation processes relevant to cloud dissipation model.

Although solar radiation is the dominant source of heat for the burn-off process, there are two other radiation processes contributing to the local heat budget. First, there is some portion of incoming shortwave radiation that is absorbed directly by the cloud (i.e., it is neither reflected by the cloud nor transmitted through the cloud). Second, in addition to absorption of long-wave radiation by the cloud, there is also an emitting of long-wave radiation from the top of the cloud, i.e., a loss of energy. During the nighttime hours, the net loss of radiation from these processes is substantial. During the

burn-off process after sunrise, the net energy loss from these two processes diminishes. The absorption of short-wave energy by the cloud increases as the incident sun angle increases, and the long-wave radiation from the top of the cloud decreases with diminishing cloud depth.

### 2.2.3. Temperature Advection

In our conceptual model, solar warming is the primary source of heat energy contributing to the burn-off process. This simple model is complicated by advection (transport by mass motion) of cooler or warmer air into the local area of interest. Advection of cooler air works to offset local heating via solar radiation, while warm air advection accelerates the burn-off process. The magnitude of the advective influence is dependent upon the difference between the local temperature and the upwind temperature and the wind speed. If there is a specific cooling or heating source upwind (such as the relatively cool Pacific Ocean to the west of San Francisco), the trajectory of the wind over the intervening surface is also an important factor. In San Francisco, a typical wind during the burn-off process is light westerly. Enhanced advective cooling results when the wind is stronger from the west (Pacific Ocean) or east (San Francisco Bay). When the wind is from the south-southwest, the trajectory of the wind over a relatively long stretch of warmer, drier land surface may contribute to enhanced warming locally. A change in the wind (either speed or direction) may greatly influence the local rate of heating during the burn-off process and be a significant factor in the ultimate timing of cloud dissipation.

### 2.2.4. Changing Inversion Base Height

We assume that the height of the cloud top is equivalent to the height of the inversion base, that is, the vertical boundary between the cool, moist marine air, and the drier subsiding air above. As described in Section 2.1., the marine inversion is the result of large scale subsidence associated with the prevailing area of high pressure in the northern Pacific Ocean. The height of the inversion, therefore, depends on the strength and location of the high pressure area. Most of the time, the synoptic scale pressure field changes slowly (on the order of days), so the change of the inversion base height changes gradually from day to day. There are some mechanisms, however, that can cause a substantial short-term change in the inversion base height that may affect the time of cloud burn-off on a given day. Figure 10 shows an example of a dramatic variation in inversion base height over two consecutive days during 1995.

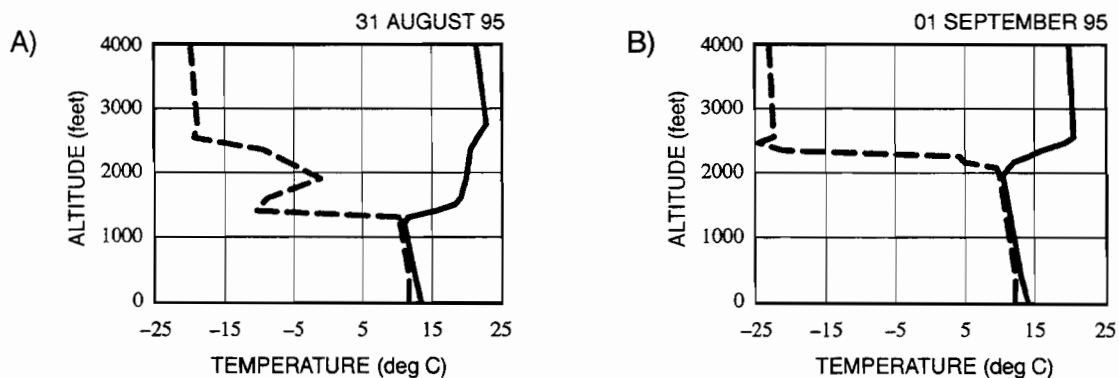

Figure 10. Oakland rawinsonde soundings for 1200 UTC on A) 31 August and B) 1 September 1995. Solid lines represent temperature, dashed lines represent dew point temperature.

The first type of mechanism is on the synoptic scale. There are a few synoptic scale features which represent quasi-discontinuities in the horizontal pressure field, and they are associated with larger-scale changes in the vertical motion field. The most common examples of these so-called “triggers” are surface fronts, pressure troughs, or vorticity maxima. (Vorticity is a measure of local rotation in a fluid flow.) The approach of one of these features results in an increase in the inversion base height, with a subsequent lowering of the inversion base height following the passage of the feature. If the timing of approach of one of these features is such that the inversion base height experiences a significant change during the burn-off process, it may greatly impact the ultimate time of cloud dissipation. Their frequency and timing is such that they are a factor for approximately 10 percent of stratus burn-off cases.

A second mechanism which alters the inversion base height is the passage of atmospheric gravity waves. These waves have a period of approximately 30–90 minutes and are observed as a high-frequency undulation in the inversion base height. Since their time frequency is relatively high and their amplitude is typically small, they usually do not impact cloud burn-off time. However, passage of such a wave at a critical time in the burn-off process may impact the cloud dissipation time by up to an hour.

One final process which may affect the inversion base height during the diurnal stratus cycle is a regional divergence of surface wind in the Bay area. This divergence (caused by horizontal differential friction or local topography) may be responsible for some “evacuation” of air below the cloud in the Bay area, resulting in a local lowering of the inversion base height in the area of interest. This gradual lowering of the inversion base height has been observed in the afternoon hours as the seabreeze circulation strengthens. It is somewhat uncertain how much this effect contributes to the inversion base height compared to the larger scale forcing by the synoptic scale pressure field.

### **2.3. Summary of Physical Processes and Assumptions**

In short, the burn-off process has been defined in terms of understanding the marine layer heat and water budgets. Our conceptual model of marine stratus cloud characteristics and important physical processes relies on the following simplifications and assumptions:

1. Total water content (liquid plus vapor) is conserved throughout the burn-off process.
2. Liquid water density increases linearly from cloud base to cloud top at some empirically known rate.
3. The marine layer is well-mixed so that incoming energy is distributed reasonably quickly throughout the marine layer.
4. Temperature advection contributes to local heat budget, but this contribution is usually constant or changes slowly during the burn-off process.
5. The inversion base height is equivalent to the cloud top height and changes slowly during the burn-off process.
6. Approach of synoptic scale features (fronts, troughs, etc.) invalidates Items #5 and #6 (slowly changing temperature advection and inversion base height).

## 3. SYSTEM REQUIREMENTS

### 3.1. Objectives

Both short- and long-term objectives were considered in determining system requirements for delivering meteorological information to improve stratus cloud forecasting. The immediate focus is on improving short-term forecasts (60 minutes or less) of cloud burn-off time since this is considered to provide the greatest operational benefit. With regard to system development, the short-term objective was to design and implement a hardware, software, and communications infrastructure to deliver new weather information to forecasters. Initially, this new information primarily consisted of time series displays of data that were previously unavailable to forecasters. The longer-term project objective is to provide more advanced derived weather products and some level of automated numerical forecast guidance. In addition, the intent will be to apply the new information and technology toward improvement the forecasting of stratus cloud onset.

This section provides a description of the sensors and data sources that were acquired for the initial demonstration. Sections 4 and 5 provide specific information as to the actual design and implementation of the initial operational system for providing the information to forecasters, as well as considerations made for a future end-state system. Additional plans for addressing longer-term objectives are discussed in Section 7.

### 3.2. Meteorological Information Requirements

In the previous section, the important physical processes associated with cloud dissipation were identified. This conceptual model was used as a baseline for establishing system requirements for data collection and display. Forecasters at the CWSU were consulted with regards to the relative value of the additional data/informations sources that were considered for acquisition.

Deployment of the initial operational system focused on acquisition of meteorological data that would provide the greatest incremental benefit within our time and budget constraints. The two areas where improved information was likely to provide an immediate benefit were identified as:

- Continual monitoring of the inversion base height (cloud top)
- Better understanding of contribution of temperature advection to the local heat budget

A brief discussion of the sensing and data acquisition associated with these two areas follows.

#### 3.2.1. Inversion Base Height, Cloud Top, and Cloud Depth

Forecasters use satellite information and surface weather observations to examine the current areal cloud extent in the Bay area and its adjacent waters. The surface weather observations also provide an estimate of the base (bottom) of the cloud at point locations. A key piece of information that is not as readily available to the forecaster is the height of the top of the cloud deck, which provides an indication of the total depth of the cloud that needs to be burned off. As mentioned earlier, this cloud top is closely related to the height of the base of the temperature inversion, i.e., the level at which the air temperature begins to increase with height. Forecasters receive a vertical temperature sounding from the Oakland rawinsonde twice daily at 1200 UTC (5:00 AM PDT) and 0000Z (5:00 PM PDT). This provides an indication of the inversion base height. Although this is useful for estab-

lishing cloud top heights at these times, there are two primary limitations: 1) there is no indication of how this level is changing throughout the day, and 2) the information at Oakland may not be representative of what is occurring at the airport, the approach zone, or along the coastline. Cloud top information is also available via pilot reports, but forecasters have indicated that these reports are infrequent and not sufficiently accurate.

As a consequence, a continuous monitoring of the inversion base height was identified by forecasters as the most desirable element of new information. This information would not only provide an estimate of current cloud depth but would also indicate the trend in cloud top height as influenced by both large-scale and regional-scale forcing mechanisms.

The two principal locations where cloud top information is most useful are the airport and the approach zone in the vicinity of the San Mateo Bridge. Forecasters have also indicated that information regarding the trend of the cloud top (inversion base) height would also be useful along the coastline to the northwest of the airport since this represents the wind direction most prevalent for significant marine air intrusion. It is also presumed that changes in the inversion base height in this vicinity along the coastline are likely a precursor to variation in heights at the critical operational locations.

### **3.2.2. Temperature Advection**

Forecasters continually monitor the horizontal wind and temperature fields in the Bay area in order to estimate the contribution of temperature advection in the regions of operational significance. They currently have access to surface data from the network of Surface Airways Observations (SAOs) from airports in the region. They also receive reports from other surface stations such as coast guard and buoy stations. Most of the surface weather data is received once per hour, plus some special between-hour reports from some stations when a weather parameter crosses over a threshold that is operationally important for aviation (e.g., cloud ceiling and visibility). In addition, wind and temperature data aloft are also important (particularly at the cloud level); this information is available from the 0000 UTC and 1200 UTC Oakland soundings. Numerical forecast model estimates of winds at the surface and aloft are also available twice per day. However, these models are somewhat limited by the sparsity of initialization data over the ocean, coarse grid spacing, and lack of fine-scale boundary layer physics which are important to the marine stratus issue.

Forecasters have indicated that an increase in data that would better identify advective cooling and warming trends would be useful toward estimating the time of cloud dissipation. This could be achieved by updating the frequency and density of reports of wind and temperature in the Bay area, particularly at key locations. Once again, the key locations are those that are relevant to indicating temperature advection trends at both the airport and along the approach zone. In addition to providing more wind and temperature data, a display that gives a visual indication of trend was also identified as useful.

### **3.3. Sensors and Data**

The primary operational objective for 1995 was to assemble the appropriate hardware, software, and communications for data acquisition and display. As such, the sensors deployed and data collected during 1995 fulfilled only a portion of the requirements identified in the previous sections. Time and budget constraints necessitated choices regarding new data acquisition. As such, much of the new data was obtained by providing appropriate communications connections to existing sensors. The new sensors that were deployed during 1995 were two acoustic sounders to measure inver-

sion base height and a radiometer to measure total downward radiation. The future deployment of additional sensors to more completely satisfy the identified meteorological requirements is described in Section 7.

Table 1 provides a summary of the new sources of data included as part of the 1995 system. The table indicates the sensor locations and the type of information available from each source. A Bay area map showing sensor locations is provided in Figure 11. The following paragraphs provide some detail regarding each of the data sources. System configuration, data acquisition, communications, and data management are described in Section 4.

**Table 1**  
**Data Sources for the 1995 Operational Demonstration**

| DATA SOURCE                  | LOCATION(S)                 | INFORMATION                |
|------------------------------|-----------------------------|----------------------------|
| Acoustic Sounders            | SFO, Dumbarton Bridge       | Inversion base (cloud top) |
| Aircraft Meteorological Data | Approach & Depart Corridors | Wind and temperature aloft |
| ASOS surface observation     | SFO                         | Temp, wind, cloud coverage |
| AWOS surface observation     | San Mateo Bridge            | Temp, wind, cloud coverage |
| Doppler SODAR                | Dumbarton Bridge            | Marine layer winds         |
| Radiometer                   | SFO                         | Warming rate               |
| Other surface observations   | Various Bay area locations  | Temp, wind, cloud ceiling  |

● **Acoustic Sounders**

An acoustic sounder emits an upwardly-directed audible (2000 Hz) signal (see Figure 12) and processes the return signal to provide an indication of the height of the inversion base. The received signal is actually a function of the refractivity of the atmosphere at each measurement level, with a discontinuity expected at the boundary of the marine layer and the warmer, drier air above [5]. The effective vertical range of the sensor is on the order of several thousand feet, with processed data available approximately once per minute. Two such sensors (AirOvironment Model 300) were made available by San Jose State University for the initial operational system. Equipment modifications were made by MIT Lincoln Laboratory to digitize the real-time data. In addition, MIT Lincoln Laboratory assumed responsibility for physical deployment of the equipment, data communications, performance monitoring and maintenance. The first of the sounders was sited at the SFO airport. The second sounder was intended to be installed near the San Mateo Bridge, but logistical problems interfered with site acquisition. Instead, it was located farther south along the approach zone at the Dumbarton Bridge at the south end of the bay.

● **Aircraft Meteorological Data**

Most air carriers in the United States are equipped to provide automated reports of wind and temperature. These data are made available through the Meteorological Data Collection and Reporting System (MDCRS). Typically, an aircraft will transmit one such report once every seven minutes. In a cooperative effort, United Airlines programmed a number of aircraft into and out of SFO to report meteorological data at the faster rate of one report per 2000 feet change of elevation, a more suitable resolution for the application of defining the vertical wind profile in the Bay area. The 2000-foot increment profiles were made available from flights into and out of SFO at an average rate of approximately one per 30 minutes from approximately 7:00 AM to 9:00 PM local time.

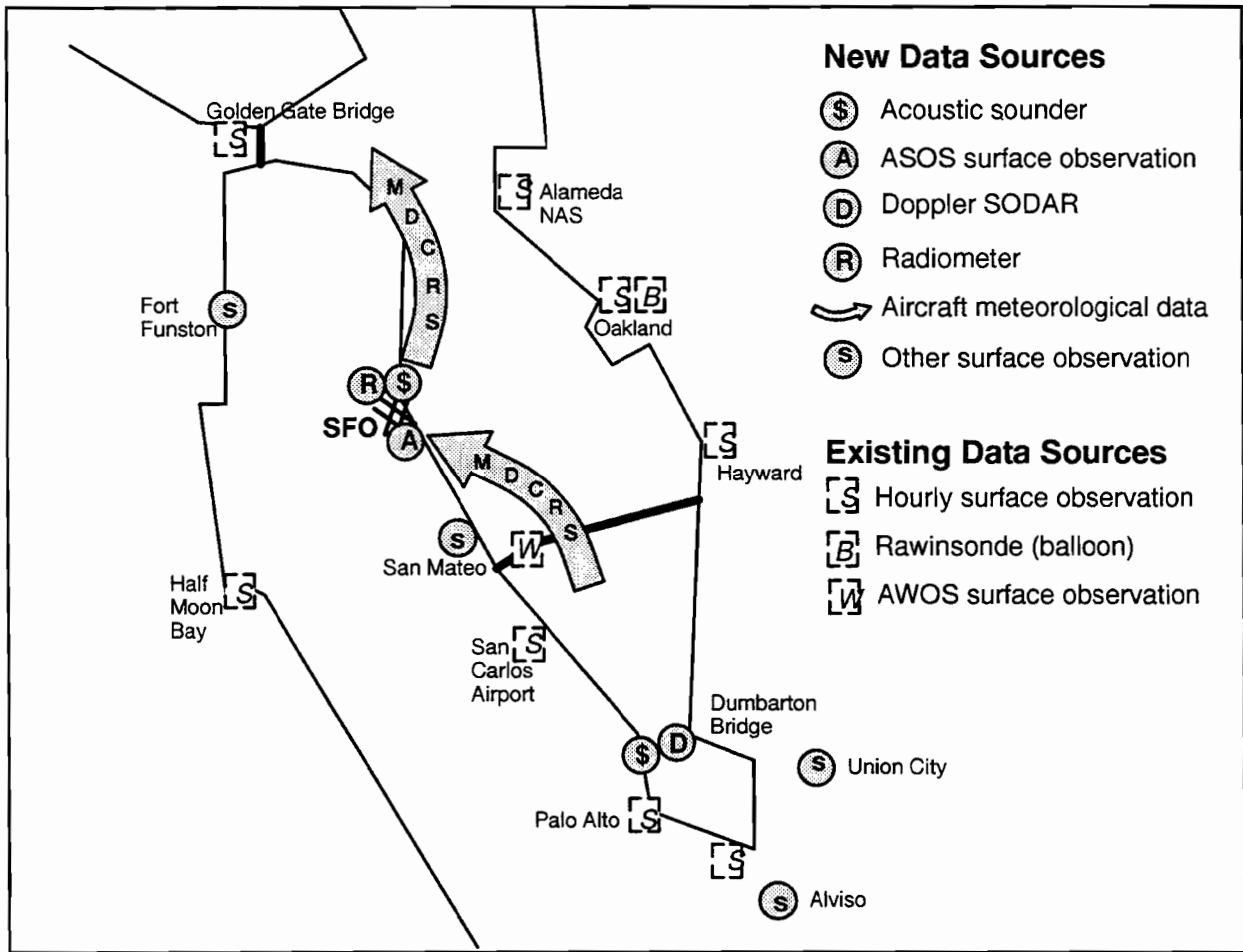

Figure 11. Location of data sources in San Francisco Bay area.

- **Automated Surface Observing System (ASOS) at SFO**

The National Weather Service is in the process of upgrading and automating its national network of surface weather observations. The new automated ASOS sensors provide a five-minute update of standard surface weather information: temperature, dew point temperature, wind speed and direction, pressure, areal cloud coverage, cloud base height, etc. Since the ASOS sensing system had not as yet been commissioned, this information was not yet available to most users. However, permission was granted cooperatively on an experimental basis to dial into the ASOS installed at SFO and provide the rapid-update surface information to the CWSU forecasters.

- **Automated Weather Observing Station (AWOS) at San Mateo Bridge**

Surface weather information (similar to ASOS) from an automated station at the San Mateo Bridge is currently available to CWSU via a dedicated line. This data stream is accessed for inclusion in the system's operational data base.

- **Doppler SODAR**

Data from a Doppler SODAR located at the Dumbarton Bridge was made available by PG&E. The data includes wind speed and direction up to a maximum height of 600 meters, at 50-foot increments. The update rate of these vertical profiles was approximately once per minute.



*Figure 12. Upwardly directly parabolic reflector, similar to that employed by the acoustic sounders.*



- **Total Hemispheric Radiometer**

This sensor provides a point measurement of total downward radiation. This includes both the short-wave (solar) radiation passing through any cloud plus the long-wave radiation emitted by the cloud itself. The radiometer was sited at the SFO airport during the latter portion of the operational demonstration.

- **Other Surface Weather Observations**

There are a number of surface weather observing sensors in the Bay area that are owned and operated by PG&E and Bay Area Air Quality Management District (BAAMQD). These sensors provide 15-minute updates of wind and temperature. (A few also include additional information such as relative humidity.) Data from four of these sensors were accessed during the latter portion of last summer's operational demonstration period: Fort Funston, Alviso, Union City, and San Mateo.

## 4. SYSTEM DESCRIPTION

### 4.1. System Design

The SFO Marine Stratus Initiative operational system is designed to provide information service to forecasters in support of marine stratus forecasting. In this context, “real time” is measured in minutes rather than seconds or microseconds. The accepted performance goals are that there should be an update of system information each 15 minutes and that the lag between the entry of new data into the system and its presentation to the forecaster should not exceed a couple of minutes. It is important that the system be reliable and that data not be lost. Since this is to serve both as an operational system and as a developmental system, a vehicle is needed to test and install product upgrades without disturbing the operational service.

The high-level design is intended to accommodate the long-term objectives of providing more advanced derived weather products and some automated numerical forecast guidance. The project began late, forcing some compromises in the 1995 implementation, and the plan was to begin service with minimal products (including commercial communications software matched to the foreign sensor platforms) and expand service during operations. First-year products were restricted to time-series displays of information from individual sensors, with minimal data archive. Data service and display are based on existing MIT Lincoln Laboratory Group 43 software libraries, Server-Client and PostPlot. This interim implementation meets near-term, real-time objectives, and there are clear paths for reuse or efficient replacement of software components as needs arise.

This implementation performs the following functions:

- Collects data from a variety of sensors each fifteen minutes,
- Parses data and creates standardized data records,
- Maintains a cache of data from the previous several hours,
- Serves these data to display and analysis functions, and
- Supports data archive.

Each sensor is accessed through a Data Collection Platform (DCP), a data logger or special purpose computer. The data is collected periodically from the DCP's by Data Routing Platforms (DRP's) using public telephone. Since many of the sensors and DCP's belong to other organizations, the data records are accessed using foreign protocols, software, and formats. The easiest way to accommodate this is to use a PC/Windows environment for the DRP's. Once the raw data arrive at the system base station computer (UNIX environment), it is transformed to standardized data records. These data records are then served to display and analysis (D&A) tasks via periodic polling by the tasks. The only automated data archive in the 1995 system is the maintenance of day files in each DRP of the raw data records from each DCP. The day files are transferred manually to the MIT Lincoln Laboratory Group 43 Data Archive.

The hub of the system is the Base Station, an SGI Indy in a laboratory at San Jose State University (SJSU). It parses the raw data records, hosts and manages the real-time data cache, and hosts one copy of the D&A functions. The data cache also provides data service to remote D&A processes. Restricted D&A products are also made available for noncritical team use via GIF (Graphical In-

formation Format) files. Sensor data flow is from the DCP's, to the DRP's, and into the Base Station at SJSU. This structure is illustrated in Figure 13.

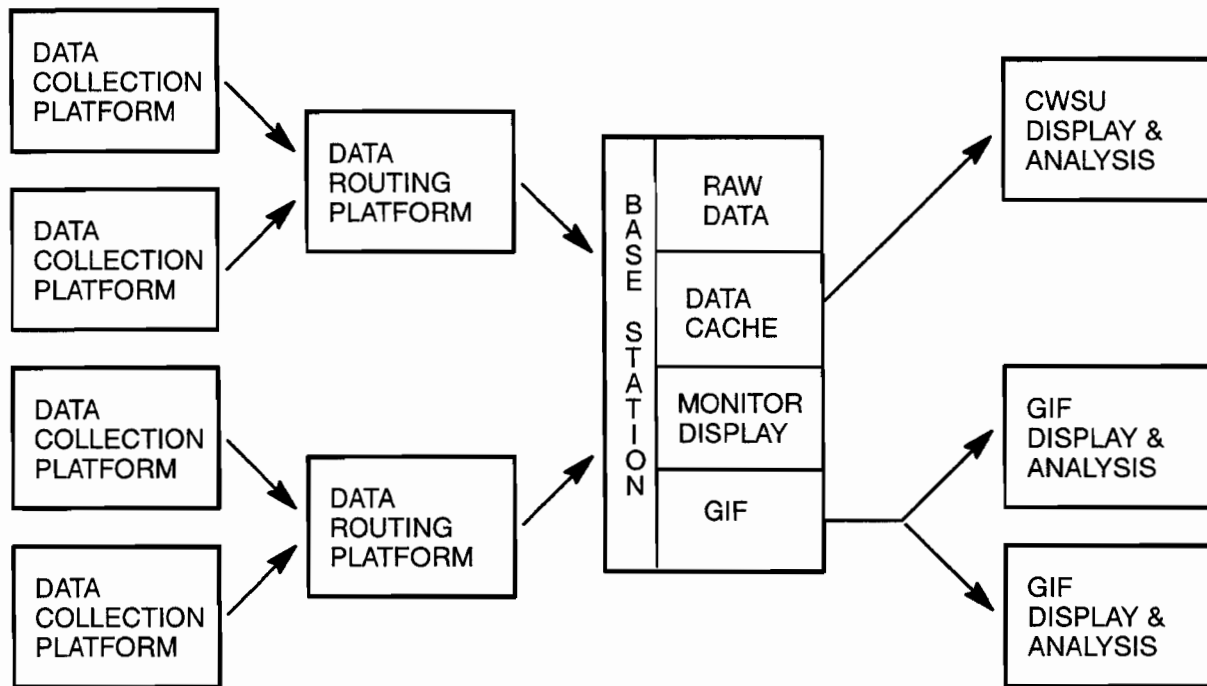

Figure 13. SFO Marine Stratus Initiative data flow diagram.

The DCP's under project control are used to collect data from the AirOvironment Model 300 acoustic sounders at the SFO site and at the Dumbarton Bridge (PG&E) site. The sounder data are accessed at 100 Hz via a PC-based A/D board using the AirOvironment software DSF-300, which is designed to operate in the Windows environment. DSP-300 is designed to run continuously and to provide a real-time display and continuous archive of the data but not to support other real-time use of the data. Project-developed software reads the output files from DSF-300 and creates data records to support our real-time analysis. A Windows-compatible scheduling program (PLUGIN) is used to stop DSF-300, prepare the ASCII data records, and restart DSF-300 each 15 minutes. This design supports the analysis and display of the sounder data, with an update increment of 15 minutes.

The 1995 system uses two DRP's to prepare files for transfer to the Base Station, manage the raw data archive (day files), and issue alerts if attempts to contact any sensor repeatedly fail. In addition to the two sounders, there are data loggers from seven different individual surface stations, the United Airlines MDCRS computer, and the National Weather Service Alert computer, making a total of 11 DCP contacts each fifteen minutes. With modem handshaking, each call takes about a minute, and call repetitions are not unusual. It is reasonable to expect a DRP to handle up to 8-10 sensors in each fifteen-minute calling cycle, so there is an expansion capability to handle several more DCP's. When its calling cycle is completed, each DRP initiates a data transfer to the Base Station. This system was turned on in late July and has run continuously with few problems.

Data service to the D&A tasks is handled by a query-response mechanism. Data transfers are initiated by each active D&A task periodically polling for new data. Robust prototype software was

quickly developed using the Group 43 Server–Client Library. This approach provides an overly sophisticated but robust software that provided trouble–free service for the limited objectives of the first year. Major drawbacks are that this software provides slow data service at the initiation of each new display task and that it is inflexible and difficult to maintain. It would require substantial redesign for this software to provide data from several sensors to a single D&A task for composite analysis. At the conclusion of the summer, it was clear that a more flexible and efficient mechanism is needed. Building on the lessons learned from 1995, an improved, simpler cache design was developed. Testing confirms that this new cache software provides significantly improved performance and the desired flexibility to support more general products.

Data are deposited into the cache by a process that periodically checks for the arrival of new raw data, parses the data records for the desired information, and formulates data records for deposit into the cache. The deposit of new data and the data service to D&A tasks occur asynchronously. Minor revisions of this software provide similar functionality for the redesigned data cache system.

#### **4.2. 1995 System Implementation**

This project has participants from several organizations who have an interest in the display products. These include:

- The CWSU forecaster at Oakland Center,
- System monitors at the SJSU Base Station,
- The NWS forecasters at the Monterey Weather Forecast Office (WFO),
- Developers from Group 43 at MIT/Lincoln Laboratory, and
- Members of organizations who are providing the project with data.

Since the forecasters at the WFO and CWSU share responsibility for providing forecasts for SFO, it is imperative that they have common information. System monitoring is essential, so there is a requirement for three complete D&A systems. The original data cache provides for this capability but is unable to provide additional D&A service. An alternative approach provides support for the developers at MIT/Lincoln Laboratory, and there was no service to the remaining team members in 1995.

Product monitoring and CWSU product service are core needs, and WFO service is less critical. The Base Station D&A tasks are cohosted with the data cache. An ISDN/PPP connection is used for the CWSU link. As an economy, the Internet is used to provide the less critical service to the WFO. The product service to the CWSU was comparable to the product service at the Base Station. Unfortunately, Internet “hiccups” caused serious degradations of the service to the WFO due to frozen socket connections.

A different approach is used to provide D&A data service at Lincoln Laboratory. The motivation for this is that the development team has a two–fold need: (1) review the performance of the operational system and (2) test proposed upgrades to the operational system. Economic factors are also a consideration. The approach taken is to send the raw data packets to a second base station at Lincoln Laboratory over the Internet. This provides the data required to operate a complete dual system as a clone of the operational system or as a beta test for an upgraded system. Occasionally, it has been beneficial to run a couple of upgrade versions simultaneously. Because of the robust design

of the data routing system, Internet delays impact only the timeliness of the system response and not the product performance. This initial implementation is depicted in Figure 14.

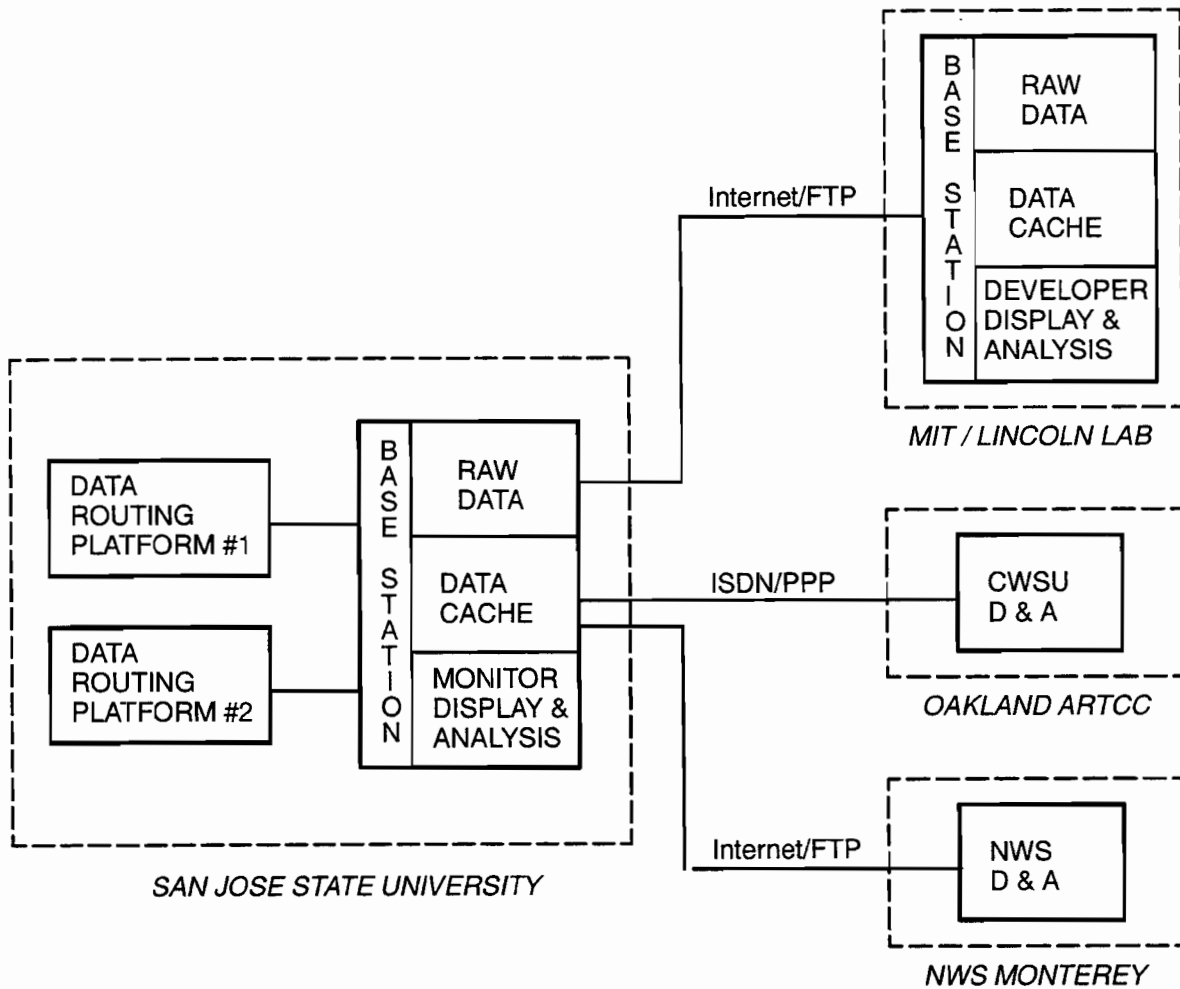

Figure 14. Initial 1995 system implementation.

The 1995 D&A products were restricted to time-series displays of data from single sensors. These displays were developed by modifying the PostPlot Library for real-time use. This implementation has been completely satisfactory and will be maintained for future use. There has been one minor drawback: the PostPlot library is limited to SGI and SUN systems, which limits the ability to provide direct product service to other team members. Fortunately, there is software available to convert PostPlot displays to GIF files, and there are publicly available viewers that display GIF files on a variety of platforms (UNIX, Windows, Macintosh). GIF-generation processes were installed during the winter of 1995-96. This upgrade is used to replace the frail product service to the WFO. It also provides an avenue for remote display monitoring by our staff and for data service to all of the team members via FTP over the Internet. This implementation is depicted in Figure 15.

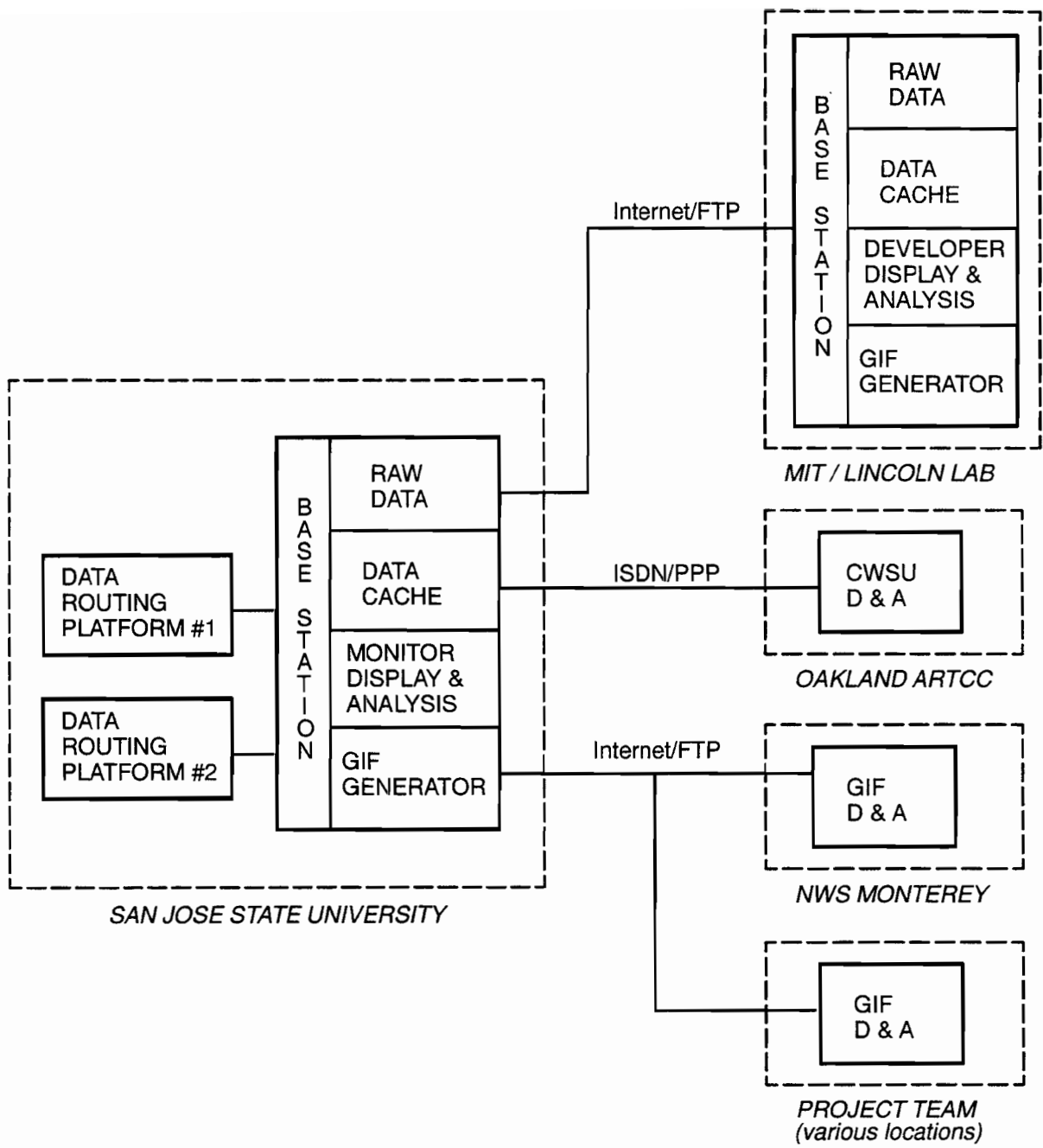

Figure 15. Current system configuration.

## 5. DISPLAY PRODUCTS

### 5.1. Display Design

The display system, called cvDisplay, is an X Windows/MOTIF application on the SGI platform that is the graphical interface to the data cache (Figure 16). cvDisplay is designed to allow the user to display any number of products based on data that are available from the sensor suite. Once a display is selected to be viewed, the system automatically updates the image with the most recent data on a periodic basis. The graphical time-series data displays are made using an in-house graphics package (PostPlot), while X Window functions are used to generate text-based displays of surface observation data. Upon start up of cvDisplay, a menu control bar appears on the terminal screen which allows the user to start the different displays. The menu bar allows the user to set the length of the time window for queries, start up the automatic data fetch, enable/disable legends on the graphs, and quit the cvDisplay system. The remaining menu items let the user open or close different graphical data displays.

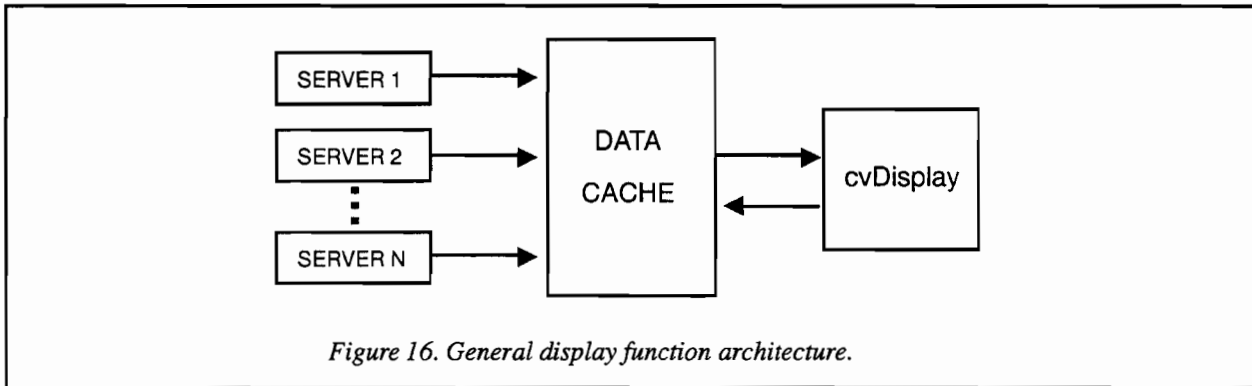

Figure 16. General display function architecture.

When the automatic data fetch option is enabled, cvDisplay will automatically make queries for data for the products that are currently being displayed on the screen. The fetch period is currently hard wired to occur every two minutes. On an hourly basis, cvDisplay also does a refresh of all of the active displays. As PostPlot keeps its own internal data cache for each display, this refresh keeps the display system performance robust and purges obsolete data.

Server-Client is the communications method used to link cvDisplay to the data cache manager. Server-Client is a record-based, header delineated system that requires that the information be packaged up in a certain discrete byte packet format and labelled with headers. Based on the displays that have been activated, cvDisplay formulates a query and sends this to the cache manager. The query contains information regarding the type of data and the time interval over which the data is requested. cvDisplay then waits for a response from the cache manager and displays the data if a response is received. If no response is received, cvDisplay simply waits until it is scheduled to make another query.

### 5.2. Display Control

The primary operator interface to the system is the control menu (Figure 17). The menu is a window application that allows pull-down selection of user options. From this menu, the user is able

to set display product control functions (e.g., begin data flow to display function, set display history period, enable display legends, etc.) via point-and-click selection of the “Controls” button. A separate button is available on the control menu for each type of display product. A drag-down menu for each button allows selection of individual products for each display type. During the 1995 demonstration, there were five product types available. The first three product types (text, time series, and ceiling) present textual or graphic display of surface weather observations, while the other two provided time-height profiles from the acoustic sounder, aircraft, and Doppler SODAR data. A description of the product types is presented in the next section.

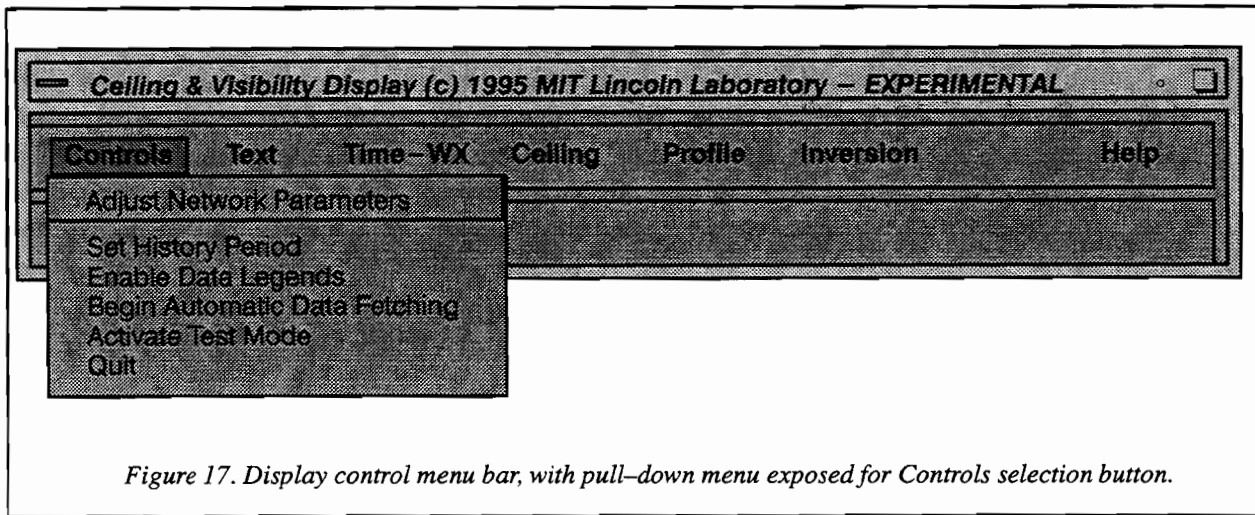

### 5.3. Display Product Descriptions

#### 5.3.1. Textual Weather Observations

The text products provide an alphanumeric presentation of the most recent surface weather observations from the two rapid-update surface stations, i.e., the five-minute data from the SFO ASOS and San Mateo Bridge AWOS (Figure 18A). These observations include sky cover conditions (cloud base height and areal coverage), sensible weather, visibility, sea level pressure, temperature, dew point temperature, wind speed, and wind direction. The product shows the most recent four observations from each of the two sensors.

#### 5.3.2. Time Series Plots of Surface Observations

The time series plots provide a graphical representation of temperature, dew point, cloud coverage, and wind from surface observing stations (Figure 18B). Each of the five-minute observations of temperature and dew point are plotted as continuous curves. The area sky coverage and wind are plotted once each 15 minutes, using the standard meteorological station plot. During 1995, the time series plots were available for the SFO and San Mateo observations. They will be made available for several more surface stations for 1996.

#### 5.3.3. SFO Cloud/Ceiling

This product presents a time-height plot of the various cloud layers reported in the SFO ASOS observation (Figure 18C). The cloud reports are color coded to indicate areal cloud coverage of each cloud layer, i.e., scattered, broken, or complete overcast.



SFO ASOS

SFO ASOS - EXPERIMENTAL - 09/10/95

| TIME  | SKY COVER | WEATHER | VIS  | PRES   | T  | TD | WIND  |
|-------|-----------|---------|------|--------|----|----|-------|
| 1940Z | 21 OVC M  | M       | 10.0 | 1016.6 | 66 | 59 | 250 4 |
| 1945Z | 21 OVC M  | M       | 10.0 | 1016.6 | 67 | 60 | 250 5 |
| 1950Z | 21 OVC M  | M       | 10.0 | 1016.5 | 67 | 60 | 340 3 |
| 1955Z | 21 OVC M  | M       | 10.0 | 1016.5 | 66 | 60 | 350 3 |

A

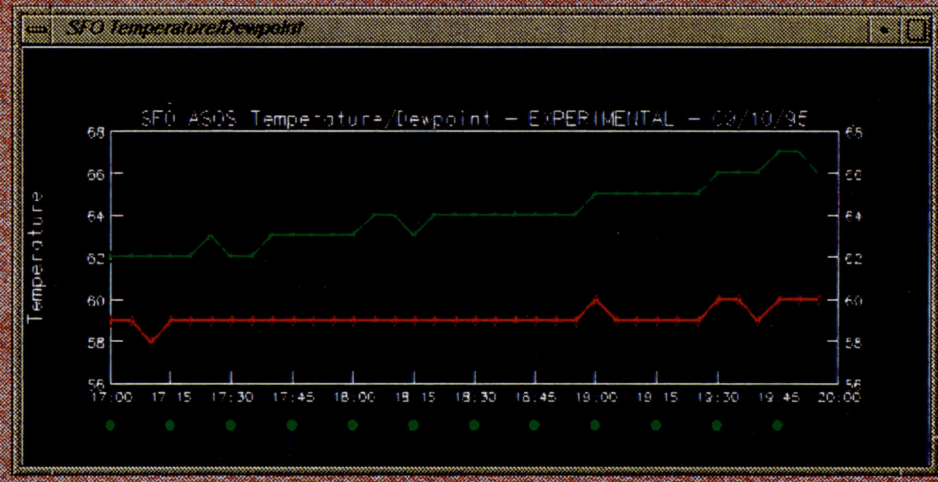

B

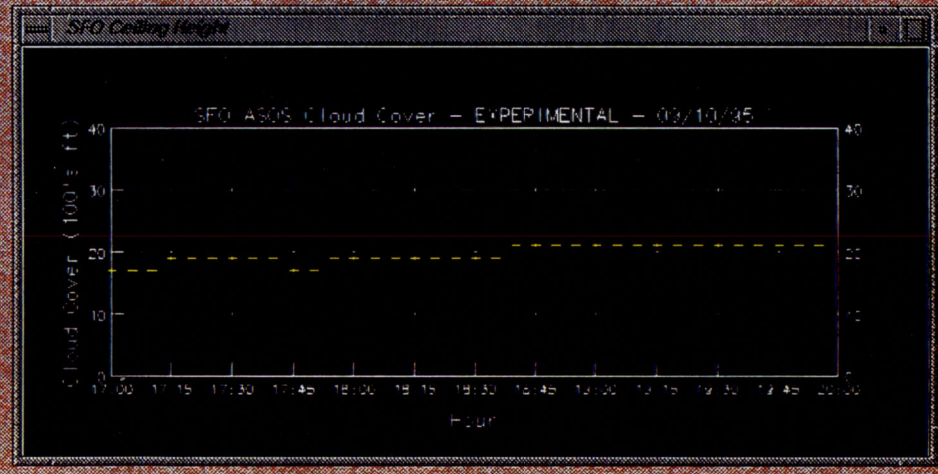

C

Figure 18. Displays of surface weather observations from SFO ASOS: A) textual reports, B) time-series of temperature and dew point, with wind and sky cover plots, and C) cloud coverage time series.

#### **5.3.4. Profiles**

Products showing time–height profiles were available for both the aircraft MDCRS data, and data from the Doppler SODAR at Dumbarton Bridge.

The aircraft profile generates two time–height weather information profiles, one each from arrival and departure aircraft (Figure 19A). Each profile shows a plot of temperature, wind speed, and wind direction from 2000 to 10,000 feet altitude at 2000–foot increments.

The Doppler SODAR profile shows a similar time–height plot of wind speed and direction (Figure 19B). These reports are available at 50–meter increments up to a maximum height of 600 meters. One vertical profile was plotted every 15 minutes.

#### **5.3.5. Inversion Height**

The inversion height product is a time–series plot of the inversion base height from the acoustic sounders at SFO and Dumbarton Bridge (Figure 20). The display is comprised of a time series of one–minute gray–scale vertical plots, where the brightness scale is inversely proportional to signal return. Thus, the inversion base height appears as a dark line representing a vertical gradient in temperature separating the cool marine layer below from the dry air above. The product is configured to display data from the surface up to an altitude of 4000 feet.



Figure 19. Vertical profile time-series displays from A) arrival aircraft reports, B) departure aircraft reports, and C) Doppler SODAR.

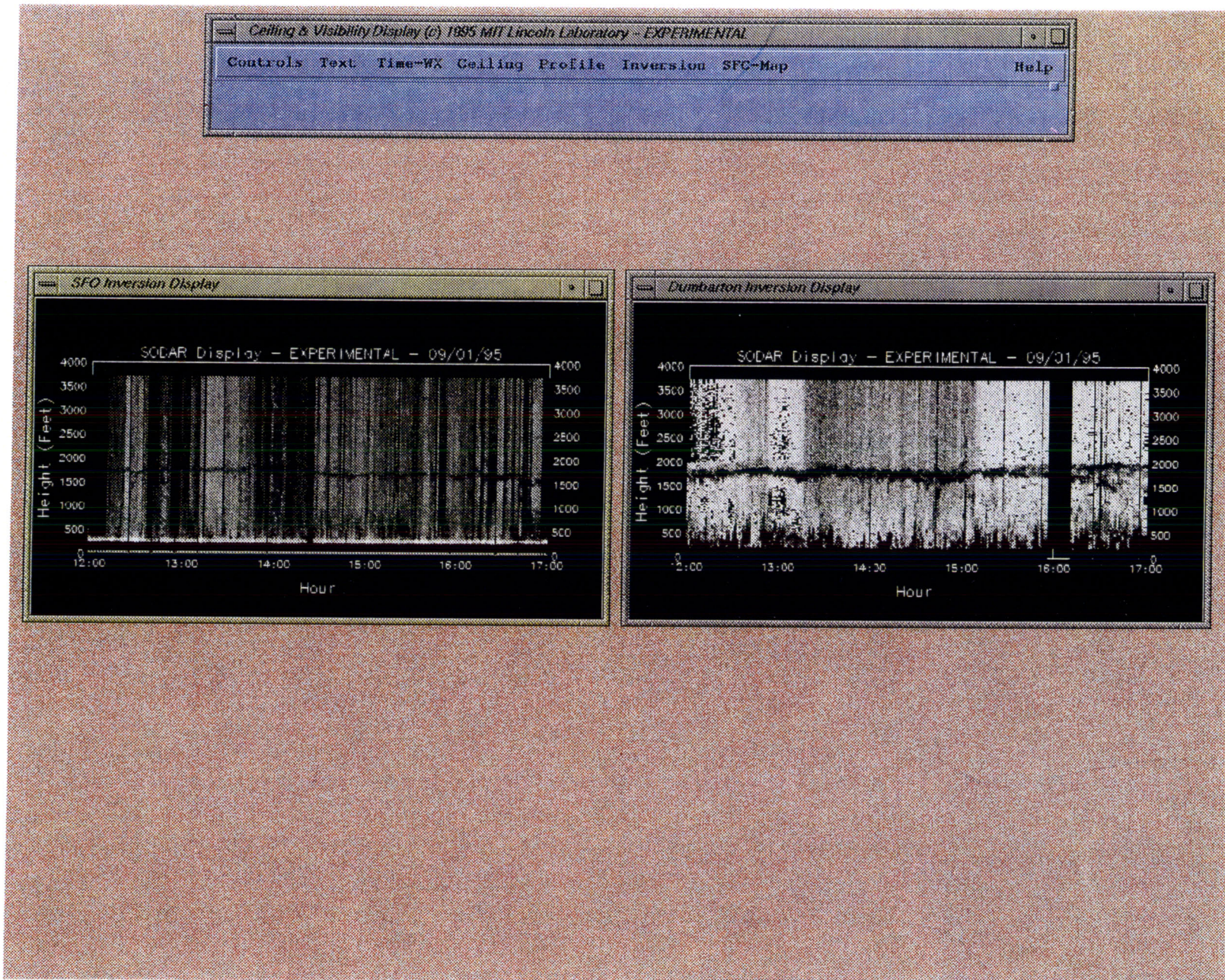

Figure 20. Displays of inversion base height time series, from acoustic sounders at SFO and Dumbarton Bridge.

## 6. OVERVIEW OF 1995 DEMONSTRATION

### 6.1. CWSU Operating Procedures

The CWSU at Oakland Center operates from approximately 5:00 AM to 9:00 PM. The initial terminal weather forecast for SFO is prepared at approximately 3:00 AM each day by forecasters at the National Weather Service Office in Monterey. This forecast is used for air traffic planning purposes at the start of each day to anticipate whether or not a delay program is likely to be needed to regulate traffic into San Francisco. One of the first responsibilities of the CWSU each day is to examine this initial forecast and prepare an updated forecast briefing for air traffic managers at approximately 7:15 AM. The CWSU forecaster is then responsible for continual monitoring of weather conditions to ensure that the forecast is on track, or provide an updated forecast as necessary. The key focal point each morning is anticipation of how the weather will impact the peak arrival period from 10:00 AM to 12:30 PM. During the afternoon, a forecast is then prepared and briefed at 3:00 PM in anticipation of the evening traffic rush from 5:00 to 9:00 PM. As in the morning, conditions are continually monitored, with forecast updates provided as necessary.

### 6.2. Initial Operational Demonstration

The initial operational demonstration began on 3 August 1995, starting with a training session for forecasters from the CWSU and the National Weather Service Forecast Office at Monterey. Products were available independently to each of these offices (CWSU and NWS). The initial display product suite included the aircraft wind/temperature profiles and the text messages and temperature/dew point traces from the SFO ASOS and the San Mateo AWOS. During mid-August, the inversion product from the acoustic sounders at the airport and Dumbarton Bridge were made available. In early September, the wind profile product from the Doppler SODAR at the Dumbarton Bridge became operational. The initial product demonstration was formally completed at the end of September. However, the displays and product availability to forecasters continued throughout the fall and winter months, albeit with a lesser degree of system support.

The forecaster for each operational shift was at liberty to configure the products on the display monitor suitable to their own preference. Forecasters were asked to log any comments regarding the usefulness or application of products to their forecasting mission or to note deficiencies or recommended improvements to individual products. Several display product upgrades were made during the demonstration period in response to these requests.

Additional data were collected toward the latter part of the demonstration period that were not available as display products to the forecasters. This included data from the hemispheric radiometer and 15-minute update surface wind and temperature data from four privately owned sensors located at Fort Funston, Union City, Alviso, and the San Mateo Bridge. These data will be used for off-line analysis and are intended for operational use during the 1996 stratus season.

### 6.3. System Performance

During August and September, system support was made available by personnel at both MIT/Lincoln Laboratory and San Jose State University (see Figure 21). Access to data and products was available in real-time at both of these sites so the system could be monitored remotely throughout

the day. Forecasters at both the CWSU and NWS were instructed to call either MIT Lincoln Laboratory or SJSU in the event of any problems with the system. In addition, there was some automated monitoring of the real-time system which activated pagers when an interruption to the raw data flow was detected.

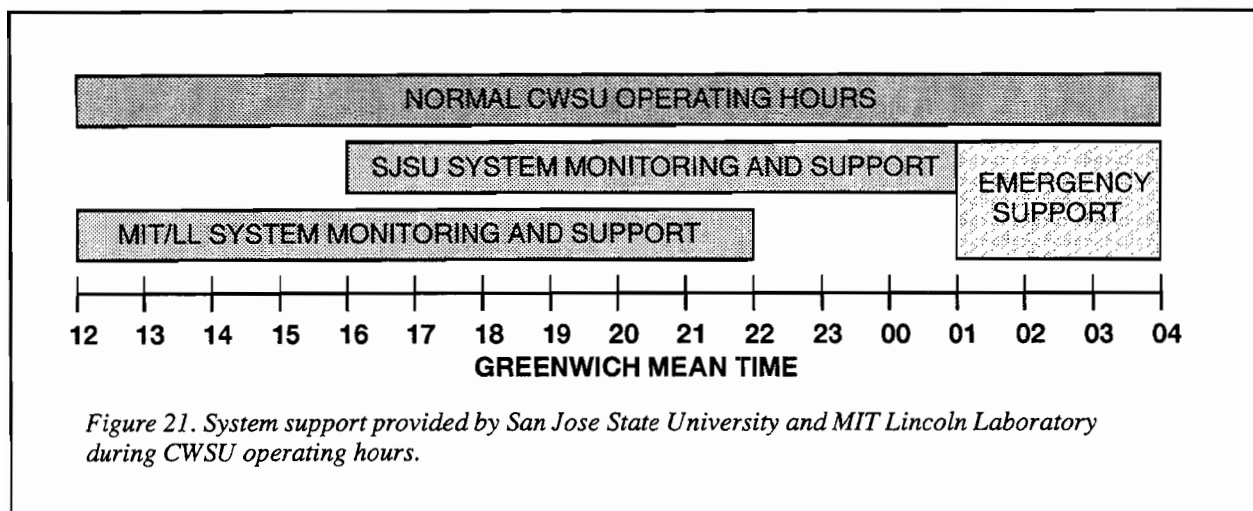

In general, the operational system performed reasonably well during the initial demonstration period. The subsystem for data collection and routing was particularly reliable and robust for most of the demonstration. Display software development was less mature at the start of the demonstration, with users experiencing periodic display problems that required resolution via remote access from either MIT Lincoln Laboratory or SJSU. Most of these problems were resolved quickly to minimize adverse impact of the users during the demonstration period. One major accomplishment during the demonstration period was an upgrade in the display system response time to user requests, which was initially unacceptably slow. In general, as the demonstration period progressed, the frequency of display problems diminished such that the display system was very reliable and robust during the latter portion of the demonstration. Following the demonstration period, it was concluded that the PostPlot graphics package remains suitable as the primary vehicle for product display.

The query-response system for data service to products and displays was found to be effective and appropriate for our needs. This technique will be maintained with some minor upgrades to the data cache system. However, it was felt that the use of Server-Client as the mechanism for query-response added an unnecessary level of complexity to the data management system that was difficult to maintain. The use of Server-Client will be replaced by a simpler system of data file transfer via standard Unix commands. This is expected to meet the data management requirement needs of the system while requiring less overhead and greater ease in maintainability.

#### 6.4. User Comments and Product Effectiveness

User response to the new information provided during the initial demonstration was generally favorable. Since the entire system was new to the users, much of the benefit of the initial demonstration was achieved by having the users gain familiarity with both the operation of the system and the new information provided in the display products, and provide feedback to MIT/LL. In addition, the incremental additions of products/information during the demonstration period allowed the users to become comfortable with existing products before new displays were introduced. However, in learning the new system and with incremental addition of new products and product upgrades,

the full benefit of the initial system was likely not realized until the latter portion of the demonstration period. This has limited objective measures of improvement in forecast performance to anecdotal evidence and discussions with users.

As anticipated, the highest value product was the continuous update of the inversion base height provided by the acoustic sounders at the airport and the Dumbarton Bridge. Forecasters cited several instances where the trend in the inversion height was cause for an amended forecast of cloud burn-off time. However, it should also be noted that the display of data from the acoustic sounders required the most interpretation of any product. At times, the signal from the sounders showed a well-defined inversion height while other times the signal was less clear or there were multiple layers indicated in the data. As such, there was a fair amount of “learning by experience” with viewing the inversion height product. Forecasters verified the accuracy of the product using pilot reports and data from the Oakland sounding. It is clear that there is still additional learning to be done with regards to interpreting the display and applying the information to the operational forecast. The initial demonstration was useful in providing a first exposure to this new information, and with continued experience it shows great promise toward providing a key element toward improvements to forecasts and forecast confidence. The decision to continue providing data throughout the winter months will allow a continuity in working with this product, which should prove beneficial toward a second operational demonstration during the 1996 stratus season.

The wind and temperature profiles provided by the aircraft data and the Doppler SODAR were identified as useful in understanding the vertical structure of the wind field above the boundary layer and in anticipating changes to wind/advection patterns within the marine layer. For example, an increase of wind speed or change in wind direction occurring at multiple levels (i.e., over an increasing depth of the atmosphere) gave an indication that a substantial change in the wind field within the marine boundary layer was to be expected. The aircraft reports of wind and temperature at 2000-foot increments also provided evidence of a sharpening or weakening inversion or a change in the inversion height. Users commented, however, that the frequency of reports was insufficient. Although the schedule of reporting aircraft (as programmed by United Airlines) is intended to provide approximately one profile per half-hour, the reports tended to come in bunches (followed by long periods with no reports) during periods of low cloud ceiling as the traffic schedule was disrupted.

The rapid update (five-minute reports) of airport ASOS surface weather data was considered useful, primarily for its wind information and for identifying changes in the dew point depression in a more timely manner. Initially, the temperature and dew point time-series plot did not include wind information. Users identified the evolution of surface wind as an important element of information, so the wind plot at 15-minute intervals was added to this product as an upgrade midway through the demonstration period. The graphical representation of cloud layers was considered the least useful of the displays associated with the SFO ASOS. Display of information from the San Mateo AWOS was not considered as a significant improvement since this information was already available on a separate FAA terminal display. However, the time-series representation of AWOS temperature, dew point, and wind were considered a useful enhancement. Unfortunately, the 15-minute update of surface weather information from other private surface reporting stations was not able to be included in the display suite during the demonstration, although collection of such data from four stations began late in the period.

## 7. PLANS FOR 1996 AND BEYOND

### 7.1. Objectives

During 1995, the primary project objective was to establish a communication, data collection, and display infrastructure to provide previously unavailable raw information to CWSU forecasters. The longer-term project goal is to provide automated or semi-automated, numerical one-hour forecast guidance of stratus cloud dissipation (refer to Section 3.1.). Therefore, in addition to providing upgraded displays and additional raw meteorological data, the upcoming year will include efforts toward providing system automation and numerical forecast guidance.

The approach for an end-state system is to develop a rules-based algorithm that examines the values and trends of key individual elements or “predictors” and applies a decision logic to present the forecaster with some numerical forecast guidance regarding the timing of cloud burn-off (and eventually onset). One possibility would be a probability forecast of cloud burn-off at key locations (SFO airport and approach zone) and a “mission” forecast, i.e., probability that cloud condition will allow dual parallel approaches within the next hour. The elements used for input to such an algorithm would include both raw data and derived information for selected key locations (airport, approach, coast, etc.).

In order to handle many of the heat and water budget issues that are critical to the burn-off process, an important extension of the project in this direction will be real-time implementation of a one-dimensional column model. This model uses both parameterization and real-time data assimilation to model the evolution of the warming of a “column” of air in the boundary layer representative of a point location. The model diagnosis and forecast of key boundary layer characteristics for point locations would become real-time input to a “mission-oriented” forecast algorithm.

The functional flow of the envisioned end-state system is shown in Figure 22. The top row of the figure represents the use of existing weather information by the CWSU to provide a cloud forecast that is applied to an operational decision by air traffic managers. The rest of the figure represents the functions of the San Francisco Marine Stratus Initiative. The three primary functional areas are data acquisition, data analysis, and operational products. To date, the operational products have consisted of real-time displays of new raw information to forecasters. During 1996 we will be adding the column model to the real-time analysis function and begin the groundwork toward providing an automated forecast as part of the operational product function. Focus on these two areas will require deployment of additional sensors. Stabilizing the sensing system during 1996 is considered an important objective since the statistical methods necessary for forecast algorithm development will require a substantial and consistent database.

### 7.2. Column Model Implementation

The application of a one-dimensional column model for diagnosis and forecast of boundary layer heat and moisture characteristics has been investigated using data collected by MIT Lincoln Laboratory at Memphis International Airport [6]. The model is currently being modified for direct application to the San Francisco marine stratus environment. Input data required by the model are from the rapid-update ASOS, radiometer, vertical rawinsonde sounding, acoustic sounder, and sonic anemometer. The sonic anemometer provides a measurement of the vertical fluxes of heat by small-scale wind perturbations. These flux measurements are considered an essential component



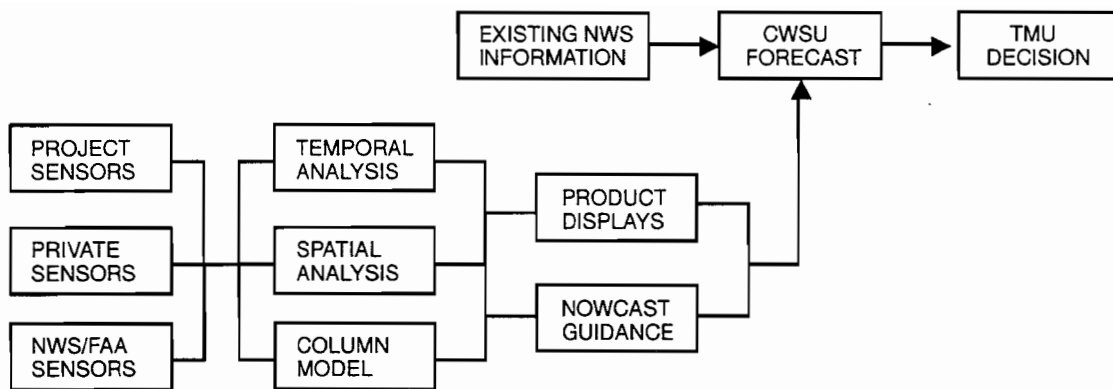

Figure 22. Functional flow diagram of end-state system.

to effective modelling of the marine boundary layer. Sensor sites at the airports at San Francisco International and San Carlos will be fully equipped to provide data required by the column model.

Output from the column model will ultimately be used as both display products for the CWSU and as input elements to a mission-oriented forecast algorithm. The model will also be used as a tool for heuristic and diagnostic case studies to reveal the important factors during either the burn-off or onset of stratus. The model will provide a general diagnosis and forecast of boundary layer characteristics, such as the vertical profile of temperature and moisture. Some of the output will be elements specific to the stratus cloud burn-off forecast. The two primary examples of this are:

*Effective Cloud Cover*: defined as the column model cloud cover consistent with the measured downward radiation. One straightforward algorithm for determining the effective cloud cover would be simply the model fractional cloud cover calculated by the column model when the downward radiation is specified using direct observations.

*Non-Local Heating*: defined as the additional heating required to account for the difference between the model boundary layer temperature (i.e., resulting from radiational heating) and the observed temperature. This would give forecasters an objective estimate of the amount and trend of non-local heating (or cooling), such as that associated with temperature advection.

During 1996, a considerable amount of effort will be focused on assessing the effectiveness of the column model in making a point forecast of cloud dissipation and understanding the dependency of its effectiveness on specific meteorological conditions.

### 7.3. Sensors

The sensing system for 1996 will be enhanced to provide information from additional locations identified as being critical to the stratus forecast and to provide additional data required by the one-dimensional column model. The acoustic sounder at Dumbarton Bridge will be moved to the San Carlos sensor site, and an additional sounder will be deployed at Half Moon Bay to provide a measurement of the inversion base height representative of the coastal environment. Additional sensors to be deployed at San Francisco and San Carlos in support of the column model include the sonic anemometers (vertical flux measurements) and pyranometers, which measure the downward short-wave radiation component. It is anticipated that the pyranometers will also be useful to directly esti-

mate and monitor the trend of liquid water content within the stratus deck. Surface weather observations from additional existing surface sensors will be acquired. Data from the other sensors deployed in 1995 will continue to be collected in 1996.

#### **7.4. Data Management**

As mentioned, the use of server–client as the medium for providing query–response service to products and displays is being replaced by a simpler data file transfer system. The query–response system will also be upgraded to provide for intelligent queries and multiple–sensor queries that will be required by more sophisticated products and displays that are anticipated for the future. In addition to greater ease of maintainability, the new file–based system provides faster response time and supports data playback capability.

#### **7.5. Displays**

The primary new display currently planned for 1996 is a regional display of the bay area that plots the most recent observation from the surface weather stations surrounding the bay. This will give forecasters a graphic image which indicates temperature advection and trends. Upgrades to existing products based on user recommendations will also be implemented. Products showing derived data (e.g., from the column model) will also be developed for off–line developmental use and ultimately will be provided to the CWSU forecasters as operational displays. Prime candidates for these displays are time series plots of measured short–wave radiation and effective cloud cover diagnosis/forecast for SFO and San Carlos as determined by the column model.

#### **7.6. Automated Numerical Forecast Guidance**

One of the longer–term objectives of the project is to provide some form of automated numerical forecast guidance. This forecast guidance would be derived from the multitude of new and existing weather information sources, including output from the one–dimensional column model. It would be “mission oriented” in that it would be targeted to identifying the time at which the area sky conditions will allow dual–parallel aircraft approaches (rather than providing a cloud forecast for a single point location). Thus, it would be based on a set of scientific and empirical rules regarding the temporal and spatial correlation of cloud dissipation in conjunction with output from the column model for point locations. Presented in a probabilistic format, it would also indicate a confidence level to the forecaster. The objective of providing this type of numerical forecast guidance is to assist the forecaster in assimilating and assessing the relative importance of the wide selection of data and information.

The development of an automated forecast guidance system will likely be accomplished in several stages. The initial stage for 1996 will include identification of the key elements or “predictors” that are most crucial as input to such an algorithm and development of data processing necessary to prepare these elements as algorithm input. Of course, one major component of this will be assessing the diagnosis and forecast performance of the column model for the San Francisco and San Carlos point locations. The approach will be to assemble a daily information file of all of the processed predictor elements. The ability to edit these files for data quality or append additional elements will be part of the developmental system. These files can then be used for statistical analysis and algorithm development. By the end of 1996, enough data should be available to begin formulation of a rules–based forecast algorithm. Data collected during 1997 will allow test and refinement of a forecast algorithm, with a more formal system–level test and evaluation expected during 1998.

## ACRONYMS AND ABBREVIATIONS

|        |   |
|--------|---|
| ARTCC  | Air Route Traffic Control Center                    |
| ASOS   | Automated Surface Observing Station                 |
| AWOS   | Automated Weather Observing Station                 |
| BAAQMD | Bay Area Air Quality Management District            |
| CWSU   | Central Weather Service Unit                        |
| D&A    | Display and Analysis                                |
| DCP    | Data Collection Platform                            |
| DRP    | Data Routing Platform                               |
| FAA    | Federal Aviation Administration                     |
| FTP    | File Transfer Protocol                              |
| GIF    | Graphical Information Format                        |
| IFR    | Instrument Flight Rules                             |
| ISDN   | Integrated Services Digital Network                 |
| ITWS   | Integrated Terminal Weather System                  |
| LCL    | Lifting Condensation Level                          |
| MDCRS  | Meteorological Data Collection and Reporting System |
| MIT    | Massachusetts Institute of Technology               |
| NWS    | National Weather Service                            |
| OAK    | Oakland International Airport                       |
| PDT    | Pacific Daylight Time                               |
| PG&E   | Pacific Gas & Electric                              |
| PPP    | Point-to-Point Protocol                             |
| SAO    | Surface Airways Observation                         |
| SFO    | San Francisco International Airport                 |
| SODAR  | Sound Detection and Ranging                         |
| SQL    | San Carlos Airport                                  |
| SJSU   | San Jose State University                           |
| TMU    | Traffic Management Unit                             |
| TRACON | Terminal Radar Approach Control                     |
| UTC    | Universal Time Coordinated                          |
| VFR    | Visual Flight Rules                                 |
| WFO    | Weather Forecast Office                             |

## REFERENCES

- [1] Federal Aviation Administration, "1994 Aviation Capacity Enhancement Plan," System Capacity and Requirements Office, Washington, DC, 1994.
- [2] Clark, D.A., internal memorandum, 1995.
- [3] Paluch, I.R. and D.H. Lenschow, "Stratiform Cloud Formation in the Marine Boundary Layer," *Journal of the Atmospheric Sciences*, **48**, 2141–2158, 1991.
- [4] Neiburger, M., "Reflection, Absorption, and Transmission of Insolation by Stratus Cloud," *Journal of Meteorology*, **6**, 98–104, 1948.
- [5] Neff, W.D., "Observations of Complex Terrain Flows Using Acoustic Sounders: Echo Interpretation.," *Boundary Layer Meteorology*, **42**, pp. 207–228, 1988.
- [6] Keller, J.L., F.W. Wilson, and C.B. Smith, "Initial Evaluation of the Oregon State University Planetary Boundary Layer Column Model for ITWS Applications," MIT Lincoln Laboratory, Lexington, MA, Project Report ATC–233, 13 April 1995.