

**Effects of Airborne Transponder Antenna Lobe
Switching on En Route (PCD) and Terminal
(BDAS) Beacon Reply Processing**

**E. H. Day
J. H. Pannell**

29 January 1974

Lincoln Laboratory
MASSACHUSETTS INSTITUTE OF TECHNOLOGY
LExINGTON, MASSACHUSETTS

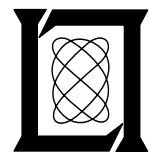

Prepared for the Federal Aviation Administration,
Washington, D.C. 20591

This document is available to the public through
the National Technical Information Service,
Springfield, VA 22161

This document is disseminated under the sponsorship of the Department of Transportation in the interest of information exchange. The United States Government assumes no liability for its contents or use thereof.

1. Report No. FAA-RD-73-109	2. Government Accession No.	3. Recipient's Catalog No.	
4. Title and Subtitle Effects of Airborne Transponder Antenna Lobe Switching on En Route (PCD) and Terminal (BDAS) Beacon Reply Processing		5. Report Date 29 January 1974	6. Performing Organization Code
7. Author(s) Ernest H. Day, James H. Pannell		8. Performing Organization Report No. ATC-18	
9. Performing Organization Name and Address Massachusetts Institute of Technology Lincoln Laboratory P. O. Box 73 Lexington, Massachusetts 02173		10. Work Unit No. (TRAIS) 15434 022-243-012 & 033-241-062	11. Contract or Grant No. IAG DOT-FA72WAI-242
12. Sponsoring Agency Name and Address Department of Transportation Federal Aviation Administration Systems Research and Development Service Washington, D. C. 20591		13. Type of Report and Period Covered Final Report - Task C Project Report	
15. Supplementary Notes The work reported in this document was performed at Lincoln Laboratory, a center for research operated by Massachusetts Institute of Technology under Air Force Contract F19628-73-C-0002.			
16. Abstract The comparative performances of switching top and bottom transponder antennas versus the bottom antenna alone, in target detection by ARTS III and by PCD, were investigated in order to determine which of the two antenna configurations is preferable. A variety of military aircraft participated, performing climbouts, orbits, straight and level segments, and descents, in order to expose a wide range of aspect angles to the interrogator. Data were collected at Washington, D. C., utilizing the ATCBI at Andrews Air Force Base, and at NAFEC, utilizing the Elwood site. The frequency of occurrence of lost targets, particularly of consecutive lost targets, was found to vary considerably from one aircraft type to another. Analysis of the reduced data provides a reasonable basis, however, for concluding that, to maximize average probability of detection, the bottom antenna is better in the terminal area but switching antennas are better for En Route application. To minimize long sequences of misses which cause track loss on turns, the switching antenna appears more favorable in both flight regimes. The data also suggest that a higher probability of detection can be obtained in both environments, without incurring serious penalties, by reducing the leading edge detection thresholds.			
17. Key Words Antennas ATCRBS Beacon Tracking Military Lobing Switches Transponders		18. Distribution Statement Document is available to the public through the National Technical Information Service, Springfield, Virginia 22151.	
19. Security Classif. (of this report) Unclassified	20. Security Classif. (of this page) Unclassified	21. No. of Pages 184	22. Price 5.25 HC 1.45 MF

PREFACE

This is the final report on Task C of the FAA Surveillance and Communications Inter-Agency Agreement DOT-FA72WAI-242. The task was an eight-month investigation of some effects of transponder lobing switches on the beacon processors used in Civil Air Traffic Control En Route and Terminal Facilities.

Many individuals, too numerous to mention, in the FAA and the military services contributed to the success of this modest project, which was conducted under the auspices of RD-240 at the request of OP-4. Data gathering at the Washington National Airport received the unstinting support of the controllers and data systems personnel. Under project 033-241-06X, the Surveillance Branch at NAFEC also played a significant role.

Enthusiastic cooperation was demonstrated by various Air Force units that provided aircraft and crews and also by the Test and Evaluation Coordinator at the Naval Air Test Center, Patuxent River Naval Air Station.

Finally, we wish to acknowledge the special assistance provided within the Laboratory by B. Cohen, D.H. Hamilton, D. Mayweather, and R. Rutberg.

TABLE OF CONTENTS

<u>Section</u>	<u>Page</u>
PREFACE.	ii
I. INTRODUCTION	1
A. Objectives	1
B. Background	1
C. Theory of Target Detection	8
II. TEST DESIGN	17
A. Data Requirements	17
B. Techniques for Data Gathering.	19
C. Selection of Sites	24
D. Selection of Aircraft Types	28
E. Flight Profiles.	35
III. RESULTS	41
A. Test Flight Operations.	41
B. ARTS III Data	46
T-29	51
T-39	57
F-106	61
A-4	64
F-105	68
C-141	72
C-1	76
C. En Route Data	80
1. T-29	84
2. T-39	90
3. F-106.	96
4. A-4	106
5. F-105.	119
6. C-141.	126

TABLE OF CONTENTS (Continued)

<u>Section</u>		<u>Page</u>
IV.	SUMMARY.	136
V.	RECOMMENDATIONS	141
	REFERENCES.	144
	APPENDIX A	145
	APPENDIX B	167

LIST OF ILLUSTRATIONS

<u>Figure</u>		<u>Page</u>
1.	Block Diagram of AN/FYQ-47 Production Common Digitizer.	9
2.	ARTS III Data Flow.	21
3.	Data Flow from the PCD.	22
4.	Decoder-Recorder System for Recording Beacon Hits.	25
5.	Test Point Employed in Extracting Beacon Reply Pulses	26
6.	Profile for Test Flight Against ARTS III at Washington National Airport	37
7.	General Plan for En Route Tests Against the Elwood Site	38
8.	Elevation Angles from Elwood	40
9.	Target Miss Rate Summary	47-48
10.	Azimuth Jitter, Terminal Area	49
11.	Estimated Probability of n or More Consecutive Misses, T-39	60
12.	Estimated Probability of n or More Consecutive Misses, F-106	63
13.	Estimated Probability of n or More Consecutive Misses, A-4	67
14.	Estimated Probability of n or More Consecutive Misses, F-105	70

LIST OF ILLUSTRATIONS (Continued)

<u>Figure</u>		<u>Page</u>
15.	Estimated Probability of n or More Consecutive Misses, C-141.	75
16.	Estimated Probability of n or More Consecutive Misses, C-1.	78-79
17a.	En Route Miss Rates	82
17b.	En Route Azimuth Jitter in Turns	83
18.	Potential Garbling of Replies from the T-29 with those of Another Aircraft	86
19.	Corroborative Evidence for Garbling of Replies from the T-29; Same Scan as Figure	87
20.	En Route Data T-29.	88
21.	T-29 Aircraft Orbiting at Salisbury.	89
22.	En Route Data T-39.	91
23.	T-39 Aircraft Performing 11 360 ^o Turns at Salisbury.	95
24.	En Route Data F-106 (EL 09) Both Antennas	100
25.	Radarscope Photograph of F-106 Beacon Replies During Turns at Norfolk, Showing Serrations Caused by the Combination of Switching and A Shadowed Antenna	101
26.	En Route Data F-106 (EL 04) Bottom Antenna	102
27.	Total Run Length vs Time for a Portion of the Turns by an F-106 with Bottom Antenna	103
28.	En Route Data A-4 Bottom Antenna	107

LIST OF ILLUSTRATIONS (Continued)

<u>Figure</u>		<u>Page</u>
29.	Range-Azimuth Picture of Replies from the A-4 at a Distance of 176 nmi.	110
30.	Replies Broken into Two Groups by the Switch Combined with Shadowing of One Antenna	111
31.	Serrated Replies from the A-4 Overlapped by Another Aircraft	112
32.	En Route Data A-4 Both Antennas	115
33.	Run Length vs Scan Number for the A-4 (2072) with Bottom Antenna Orbiting at Norfolk.	117
34.	En Route Data F-105	120
35.	F-105 Aircraft in Two 360° Turns at Norfolk, Both Antennas Active	122
36.	F-105 Aircraft in Second Two Turns at Norfolk, Where 31 Lost Targets Occurred Principally in Two Strings	123
37.	F-105 Aircraft in Last Two Turns at Norfolk, Where 6 Targets Were Lost	124
38.	En Route Data C-141	129
39.	C-141 in Turns at Salisbury with Bottom Antenna	132
40.	C-141 in Turns at Salisbury with Bottom Antenna	133
41.	C-141 in Turns at Salisbury with Top Antenna	134
42.	Serrated Replies from the C-141 Produced by the Switch Combined with Shadowing of One Antenna	135

LIST OF TABLES

<u>Table</u>		<u>Page</u>
I.	ARTS III Beacon Target Detection Parameters.	15
II.	Typical ARTS III Target Detection Parameters.	16
III.	Military Aircraft Causing Problems in Air Traffic Control.	29
IV.	Synopsis of Test Flights.	42
V.	T-29 Turns at Ranges > 25 nmi	51
VI.	T-29	56
VII.	T-39	58
VIII.	F-106.	62
IX.	A-4.	65
X.	F-105.	69
XI.	C-141.	73
XII.	C-1.	77
XIII.	Sources of Data for the T-39 Test Flight . .	93
XIV.	Sources of Data for the A-4 Test Flights . .	114
XV.	Sources of Data for En Route Test of C-141 .	128
XVI.	Tracking Performance for C-141 Aircraft . .	131
XVII.	Preferred Antenna Configurations	137

GLOSSARY

ADW	Andrews AFB
AIMS	Compatible DOD-ATC Beacon System
ARSR	Air Route Surveillance Radar
ARTCC	Air Route Traffic Control Center
ARTS	Automated Radar Terminal System
ASR	Airport Surveillance Radar
ATCBI	Air Traffic Control Beacon Interrogator
ATCRBS	Air Traffic Control Radar Beacon System
BDAS	Beacon Data Acquisition System
BRG	Beacon Receiver Group
BRV	Brooke
CCV	Cape Charles
CD	Common Digitizer
COMDIG	Common Digitizer Subroutine of Data Reduction and Analysis Program
DIT	Dual Input Transponder
DRANDA	Data Reduction and Analysis Computer Program
DRG	Data Receiver Group
IFF	Identification of friend or foe
NAFEC	National Aviation Facility Experimental Center
NAS	National Airway System
NASPO	National Airways System Project Office
ORF	Norfolk
PCD	Production Common Digitizer
PICT	Picture - computer printout of video data
PPI	Plan Position Indicator
PXT	Patuxent River
RVDP	Radar Video Data Processor

SBY	Salisbury
SIE	Sea Isle
SLS	Side-Lobe Suppression
TCA	Terminal Control Area
T _L	Leading Edge Threshold
TPX-42	Small Automated Terminal Facility
TSC	Transportation Systems Center
T _T	Trailing Edge Threshold
VORTAC	Combined VOR and TACAN Navigational Aid

I. INTRODUCTION

A. Objectives

The investigation, which is the subject of this report, was intended to compare the performances of the switched top-bottom and the bottom-only transponder antennas when used with the ARTS-III and PCD beacon reply processors. Because numerous factors in addition to the beacon antenna can affect the probability of detection, the tests were designed to minimize the influence of other variables by duplicating all conditions, to the extent this was possible, for each antenna configuration.

The basic data from which to draw conclusions regarding the relative efficacy of the beacon antennas are lost targets. Azimuth jitter was also considered as a secondary criterion of performance. It was decided, at an early stage of the investigation, that the individual replies on which the target detection logic operates were also required.

The variety of size, planform, antenna placement, etc., exhibited by military aircraft would have an important effect on the results. Therefore, it was planned to include in the test flights as many different types of properly equipped aircraft as possible, commensurate with their populations and availability.

B. Background

Switching between top and bottom antennas is a technique introduced by the Air Force to permit air-to-air IFF with more nearly complete spherical

coverage than a single antenna can provide. A cycling rate of 38 Hz has been adopted, using a diode switch, which results in dwell times very close to 13 msec per antenna. Some military aircraft are now equipped with, and utilize, this switch.

Since the widespread incorporation of SLS into the ATCRBS, the problems posed by lost and broken targets and azimuth jitter have become relatively more important than false targets. These problems are likely to be exacerbated, on theoretical grounds, when an aircraft uses switching antennas. Because of the way the information in the controllers' survey was gathered, it does not provide conclusive evidence for the effect of switching [1]. However, it does suggest that a potential difficulty may arise in the future when the control of air traffic becomes more fully automated and less reliance is placed on voice communication.

A number of previous tests have been made to ascertain the effects of switching antennas on the probability for a target to be declared by the digitizer. In almost every test, a comparison was sought between the probability of target declaration with switching and with bottom-only connection on the same aircraft performing the same maneuvers in the same area.

One of the earliest tests was conducted at NAFEC in 1966, employing a JC-131 aircraft, the APX-64* transponder, and a switch [2]. Data were collected at the Elwood RVDP where the replies were quantized, detected, processed and validated; the digital target messages then being transmitted

*No longer typical of current transponders.

to the DRG at NAFEC. The aircraft performed one-minute holding patterns and 360° turns at a 15° bank angle, at a distance of 50 miles, and an in-bound radial flight, all at an altitude of 12,000 ft. Two thresholds were employed in the RVDP: $T_L=6$, $T_T=3$; $T_L=4$, $T_T=2$; the first being the normal setting, the second a more sensitive one. The results indicate that, with normal settings, a bottom-only antenna performed better than switching antennas and that switching with a longer dwell on the bottom is better than an equal dwell on each.

At about the same time, another test with an instrumented JC-131 was run in the NAFEC-JFK area utilizing an antenna switch with lobing rate adjustable between 0 and 1 KHz [3]. Data were collected at two sites: one was the modified RVDP at Elwood, N.J., which transmitted narrow-band data to the DRG, etc., at NAFEC; the other was a BVD at MacArthur Field receiving and processing video data relayed from JFK. At both sites, computer printout was generated. The aircraft flew a variety of patterns and antenna configurations were varied between bottom-only, switching at 38 and 60 Hz rates, with equal time sharing, and switching at 38 Hz with the bottom antenna on twice as long as the top one. At the RVDP, values of 6 and 4, for T_L and 3 and 2, for T_T , were again utilized whereas for the BVD, $T_L=2$, $T_T=1$ and 6 hits on Mode 3/A were required for a confidence check. The results indicate that target detection and code reporting are degraded in the "normal" RVDP by switching. However, for lower values of T_L and T_T , better results appeared to have been obtained by switching. In the BVD, switching had little effect. Although the aircraft executed a number of 15°

bank angle turns through 360° , and one-minute holding patterns, it appears unlikely that either antenna was shadowed for an appreciable period: hence, a significant difference between switching and bottom-only would not have been expected.

In 1968, FAA/DOD conducted flight tests in the New York area, again with an instrumented JC-131, to evaluate the performance of the ATCRBS in a high interrogation-density environment [4]. Although only the standard bottom antenna configuration was used, information gathered on missed beacon reports, several of which exceeded a dozen consecutive scans is of interest here because it demonstrates conditions under which the transponder antenna is shadowed.

Also, during 1968, a 30-day summary of deficiencies was provided by air traffic controllers at a number of selected sites. These were gathered by means of questionnaires that were filled in by the controllers and, hence, were highly variable in subjectivity, content, and value. As an example, tracking deficiencies are expected to be aggravated by increased traffic density, but it is in just such circumstances that a controller is too busy to fill out a questionnaire. In any event, the three most common deficiencies--false targets, ring around, and broken slashes--could be attributed to sidelobe interrogation and could be cured by SLS. Since 1968, SLS has been installed at all FAA sites; consequently, the controllers' survey taken in December, 1971, as would be expected, is indicative of the greater relative importance of missed beacon reports.

One possible solution to the shadowing problem is to employ both an upper and lower antenna and to select automatically the one receiving the

stronger interrogation, as described by G.E. Hart in a report published in 1964 [5] and, in a different version, by J. Blazej in a report published in 1971 [6]. The latter dual input transponder (DIT) was tested on a Grumman G-159, and a Convair CV-880-M in a moderately comprehensive set of maneuvers related to takeoff, landing, and 360° turns, at NAFEC and JFK. In order to collect data on individual hits, the decoded transponder replies were displayed on an expanded PPI and photographed continuously by a 35-mm camera triggered once for each antenna rotation. As a backup, an HP-523 counter was gated on and off at the same time as the camera. Separate dots comprising beacon replies were counted on each photographed scan. Missing replies left gaps in these strings of dots; hence, their number was estimated for each scan and added to the number of hits to give run lengths. Data were tabulated and analyzed in terms, then, of run length rather than of hits. Therefore, although the DIT consistently produced a higher percentage of longer run lengths than did a single antenna, the results cannot be applied directly to an evaluation of the improvement expected in target reports.

In the latest tests, of April 1972, an F-106 with switching antennas was flown around NAFEC and data were collected at the Elwood site. Preliminary results were obtained from a paper tape recording run length per scan at the RAPPI; supplementary data were collected on magnetic tape for later reduction. This test also employed a tracking radar to produce a plot of aircraft ground track, with time hacks, as an aid in correlating run length with maneuver. Like previous tests, this one produced few results that give quantitative indication of the effect of switching and its value was reduced because an accompanying aircraft, equipped with bottom antenna only, failed to participate.

The genesis for this particular investigation was a joint DOD/FAA meeting, on February 3, 1972, on Airborne IFF Antenna Problems, conducted as a result of a written recommendation by FAA Deputy Administrator, Kenneth M. Smith, and chaired by Joseph Herrmann, Op-4. Previous tests and analyses were reviewed and general agreement reached on the need for further testing. It may be inferred, from the minutes, that it was intended that this would include tests against ARTS III, PCD, and TPX-42, with aircraft equipped with single antennas, and with top and bottom antennas connected in parallel and to a lobing switch. As a result of the meeting, a letter dated 7 February was written by OP-4 to EM-1 indicating the need for a transponder antenna test project that would answer the following four questions:

1. Is a parallel connected dual aircraft antenna system satisfactory for (a) terminal operations, and (b) for en route operation?
2. Is a cycling switched dual aircraft antenna system satisfactory for (a) terminal operations, and (b) for en route operation?
3. Can any changes be made to the ground processor (common digitizer) or the switching rate to overcome reported azimuth errors associated with the cycling switched dual aircraft antenna system?
4. Can procedural changes effect a satisfactory solution?
For instance, could a cycling switched antenna be used

in terminal airspace and reset to a bottom antenna only
for en route phase of flight?

In response, EM-1 requested RD-200 and OP-4 to define the scope, cost, and schedule for the work and this information was provided in a letter from RD-242 dated 7 March 1972. It provided for a **modest effort** to plan the tests, coordinate the use of DOD and FAA facilities, and to reduce, analyze, and report the results. Attention is limited to ARTS III and NAS Stage A sites and to a comparison of switching with parallel antenna configurations.

Shortly after the task was assigned to Lincoln Laboratory, representatives of the Laboratory visited FAA and discussed its objectives with Joseph Herrmann and L/Col. Alan N. Good. They thereafter met representatives of NASPO to determine a suitable location and time for the En Route tests, and with TSC to discuss utilization of the ATCRBS Simulator Computer Model in conjunction with the test flights. As a result of these discussions, a provisional understanding of the technical objectives and output data requirements of the tests was achieved. A tentative draft of a test plan was provided SRDS and discussed at a meeting at FAA on June 14, attended by representatives of SRDS, OP-4, USAF, USN, TSC, and M.I.T. In this plan the need for hit counts, or individual beacon replies, for verifying the sources of lost targets, was described together with means for obtaining them. The meeting served to provide additional inputs to the test plan and also to justify, to the military services, the need for supporting aircraft flights.

Preliminary test flights were conducted against the Washington ARTS III, in July, and the Elwood PCD, in August, whereafter a final test plan was

developed and forwarded to SRDS. As a result of comments from NAVAIR and the AIMS Project Office of ESD, and Hq./FAA, the objectives of the following tests were limited to gathering and analyzing data on the comparative performances of the bottom only antenna and switching antennas in order to permit recommending a preferred antenna configuration for each aircraft during the various flight regimes. A variety of aircraft, not specified by type, was to be included and the foremost criteria for performance were to be target detection and range and azimuth variations. It was agreed that supplementary information, if available, at no additional effort, e.g., on the top antenna alone or on the Hartlobe system, would also be gathered. Tests were to be conducted at one En Route and one ARTS III site and under realistic conditions of traffic density.

C. Theory of Target Detection

1. Production Common Digitizer

The PCD is the standardized version of the Radar Video Data Processor (RVDP), and is common to joint AF/FAA sites (as the FYQ-47), and to pure FAA sites (as the FYQ-49). It is now used in conjunction with the ATCBI-3 for beacon operation, and is widely deployed to provide digitized data to the ARTCCs. A functional block diagram is shown in Figure 1. Statistical beacon target detection employs an 11-hit wide sliding window operating on Mode 3/A replies. The normal interlace of interrogation modes is 3/A, 3/A, C, for FAA sites, and 3/A, 2, 3/A, C, for joint-use sites. No defruiter is used ahead of the PCD and the leading edge threshold, T_L , is set for each site to provide the desired probability of detection with an acceptable false alarm rate.

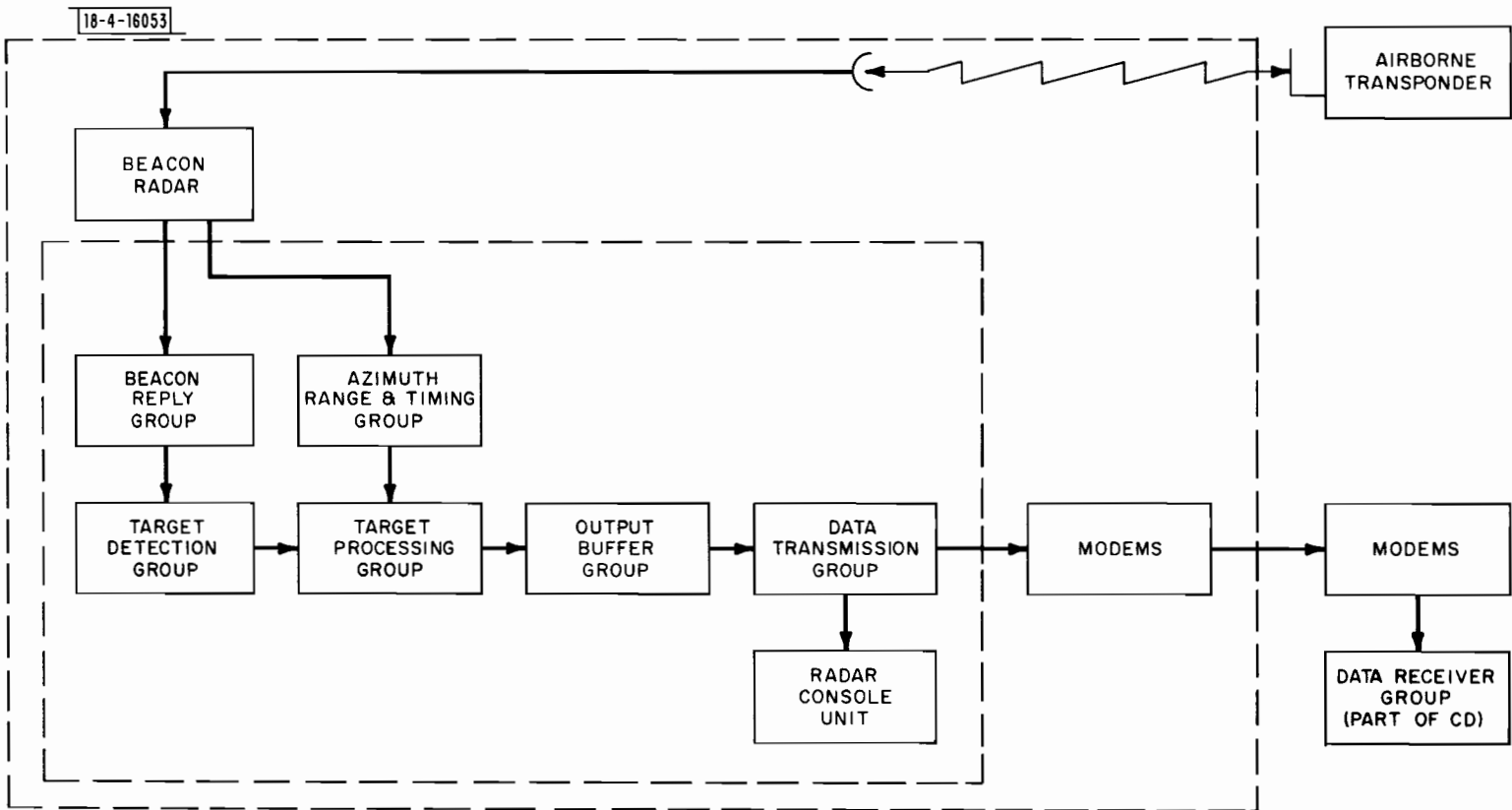

Fig. 1. Block diagram of AN/FYQ-47 production common digitizer.

The detection process takes place in four steps:

- (1) Verification of pulse characteristics; i. e., amplitude and width, and generation of an amplitude standardized signal.
- (2) Detection of bracket pulses; i. e., F1 and F2 spacing of $20.3 \pm 0.1 \mu\text{sec}$.
- (3) Summing of replies, at the same range, in the sliding window -- an azimuth-oriented shift register.
- (4) Determination of code, when the number of replies exceeds a validation threshold, T_V , by comparison of sequential pulse patterns.

The most important step in the process is the summing of replies in the sliding window, because of the obvious and direct effect that round reliability and the choice of T_L have on the probability for target detection. When the sum of hits in the window falls to a second pre-set value, T_T , the end of the target is declared and its azimuth calculated by halving the sum of the start and stop azimuths. In one of a number of studies of target detection, it was shown that the optimum value of T_L is one-half the width of the sliding window plus one. In practice, values of six or seven for T_L are found, almost exclusively. Also, generally adopted are values of two-four for T_T and three-five for T_V .

Garbled replies are sensed and flagged: interleaved but ungarbled replies from two aircraft, viz., pulses not overlapping, are correctly and separately decoded.

2. Effect of Lobing Switch

The lobing switch permits time-sharing between top and bottom antennas and operates at a rate of 38 Hz for the SA-1474/A, or 20 Hz for the CS-432/A. Both are designed to make-before-break and thereby to eliminate the effects of dead time. Switching is important when one antenna is shadowed for replies would then be received from the other in groups alternating with groups of misses for periods of 13.15 or 25.0 msec. Consider first the SA-1474/A switch, an ATCBI PRF of 360 Hz, a 3/A, 3/A, C interlace, a beamwidth of 4°, and a scanning rate of 6 rpm -- conditions typical of an En Route site. An average run length of 40 would be expected and, if one antenna is shadowed, the runlength will be broken into alternating groups of five hits and five misses (4.74 average). Thus, the reply patterns would be as shown by the following example:

Replies:	3	3	C	3	3	3	C	3	3	C	C	3	3	C	3
Window:	1	2		3	4		5	6		7	8		9	10		11									

where it is intended to show that the groups contain repetitive sequences of 4, 3 and 3 mode 3/A replies. An 11-hit window would contain a maximum of six or seven replies at the end of the second five-hit group, regardless of whether or not the first complete group begins with a 3/A or a C reply.

For the slower switch, the groups are nine-hits long; consequently, the sliding window will never contain more than six hits in mode 3/A -- the number in a single group. Furthermore, only two nine-hit groups would occur, per scan, so that a round reliability > 95% is necessary to permit attaining a T_L of six with one or the other group and declaring a target.

Azimuth splits and jitter can also be exacerbated by this switch. Clearly, with a perfect round reliability, a T_L would be found for the first full sequence of hits, but this may shift from one full group to the next, i.e., as much as nine times the number of degrees per trigger, and the target azimuth thereby shift by $\sim 0.5^\circ$. A more comprehensive analysis of the effects of the lobing switch on azimuth errors is contained in the report of Britton [3].

It can be deduced that the value of six for T_L requires a high round reliability in order to have a target declared with either switch, when one antenna is shadowed. The maximum number of mode 3/A replies that can be found in the sliding window is seven for the SA-1474/A and six for the CS-432/A.

The primary En Route site employed to gather data for this project was at NAFEC Elwood where a 3/A, 3/A, C interlace was employed. However, data were collected, as opportunity provided, at three other En Route sites at two of which the 3/A, 2, 3/A, C interlace was employed. For the 38 Hz switch this results in two different situations depending on whether or not the first hit of a complete group was in mode 3/A. If it was, then each group contains 3 such hits and, with an RR of 1.0, P_D again is 100%: if it was not, then each group has but 2 such hits and P_D is zero. It can be inferred that this interlace pattern will give an average blip/scan ratio of 0.5 under those conditions, as the reply patterns below demonstrate:

Replies: 3 2 3 C 3 3 C 3 2 3 3 2 3 C 3
Window: 1 2 3 4 5 6 7 8 9 10 11
Result: 6 hits - target

Replies: 2 3 C 3 2 C 3 2 3 C 2 3 C 3 2
Window: 1 2 3 4 5 6 7 8 9 10 11
Result: 5 hits - miss

A discussion of the data gathered on two aircraft by the joint USAF/FAA sites that employed the 3/A, 2, 3/A, C interface is contained in Appendix B.

3. Target Detection - ARTS III

In contrast to the PCD, target detection in ARTS III is performed by software. The target detection logic consists of a predetector and an expanding window. The predetector declares target leading edge, T_L , if N consecutive hits are received before M consecutive misses. Once T_L is declared, a window is maintained by hit and sweep counters and expanded with each sweep. Expansion continues for a minimum number (RMr) of sweeps (approximately one beam width). The window is maintained to insure that a split target is not declared as two targets. After a minimum run length has been attained, the target trailing edge, T_T , is declared after a number (My 4r) of consecutive misses are received. If T_T has not been declared after a relatively large number (RINGr) of sweeps, the target is considered a ring around.

Upon detection of T_T , the total number of hits received is examined to determine if a target should be declared. A minimum number (Hy 4r) of hits must have been received for target declaration to be made; fewer than

this number of hits results in discarding the record. Ring-around targets are declared if a ring discard flag (Rd) is not set. All targets considered ring around are maintained for a parametric number of sweeps (INHIB) in order to inhibit further attempts to declare a target at that range. Table I lists the beacon target detection parameters used in ARTS III. Typical values for the detection parameters are listed in Table II for Andrews Air Force Base, Maryland; Washington National Airport, Washington, D.C.; and Logan Airport, Boston, Mass. For the switched antenna test, video from the Andrews AFB was used as input to the ARTS III processor at Washington National Airport. The detection parameters utilized were those listed for Washington National.

In order to reduce the number of isolated replies entering the processor, single defruiting in both modes 3/A and C is employed at Washington. This exacerbates the effect of the lobing switch as it causes loss of the first reply in each mode in each group of replies.

Table I. ARTS III Beacon Target Detection Parameters.

PARAMETER	FUNCTION	VALUE RANGE
My3	Value of MISS at which record discarded prior to leading edge detection.	2-8
Hy3	Value of HIT at which leading edge shall be declared.	2-5
My4r	Minimum value of MISS at which trailing edge shall be declared.	2-8
Hy4r	Minimum allowable hits per target.	7-27
Rmr	Minimum allowable run length (sweeps) in target split determination. Must be $> My4r + Hy4r$.	9-35
TQyr	Number of HITS for strong target.	4-27
RINGr	Maximum number of sweeps allowed before target is declared a ring around.	30-60
INHIB	Total sweeps to inhibit a ring around. Must be less than scan PRF rate.	31-1600
Rd	Ring discard flag. Ring-around targets shall be discarded if this flag is set and declared if not set.	0-1
f	Coefficient of BAMS/SWEEP for Center azimuth computation. $f = 4096/n$ where $n = \text{number of sweeps/scan.}$	

Table II. Typical ARTS III Target Detection Parameters.

	Andrews		Used for our test Washington National		Logan	
	<u>3/A</u>	<u>3/A & C</u>	<u>3/A</u>	<u>3/A & C</u>	<u>3/A</u>	<u>3/A & C</u>
Leading Edge (Hy3)	2	4	3	3	3	3
Elim. Record (My3)	4	3	3	2	3	2
Min. Number (Hy4r)	4	6	5	7	6	6
"Strong" (TQyr)	10	12	9	13	11	14
Trailing Edge (My4r)	4	4	5	4	5	4
Ring around (RINGr)	30	30	30	30	N/A	N/A

Look for trailing edge after 13 sweeps (A)

11 sweeps (A & C)

II. TEST DESIGN

Design of the tests was influenced by several constraints under which the entire task was conducted. A more conclusive test would include consideration of additional factors that should be controlled in an experimental investigation. Some of the constraints, in addition to the overall very tight schedule for conduct of the entire investigation, are the following:

(1) Aircraft. These were to be provided by USN and USAF, the latter in conjunction with training flights rather than as dedicated missions. Modifications, or the addition of instrumentation, were not permissible, nor was the presence on-board of a laboratory representative.

(2) Sites. The tests were to be conducted on a noninterference basis, at an ARTS III and an En Route site, with standard equipment configurations. Thus, no modifications were to be made to the equipment, which was to be either in commission or in a comparable condition.

(3) Data Gathering and Reduction. It was originally envisaged by FAA that the tests would be conducted and data gathered in a hands-off fashion; hence, little effort on the part of the contractor was to be allocated to these tasks. It was similarly assumed that the standard output, e.g., DRANDA [7] program printout for the PCD, would provide an adequate data base.

A. Data Requirements

Target declarations in both ARTS III and En Route Stage A systems contain the estimated range, azimuth, altimeter readout, code, and an indi-

cation of whether weak or strong, on each scan. If the beacon data processors are working properly, and no targets are lost, no further information is required. On the other hand, when a target is lost it may be for one or more of the following reasons:

1. Low effective radiated power from the interrogator.
2. Low effective sensitivity of the transponder.
3. Transponder capture by other interrogators.
4. Low effective radiated power from the transponder.
5. Low effective sensitivity of the interrogator.
6. Errors in code introduced by, e.g., synchronous garble.
7. Errors in the processors.

It is assumed, of course, that the aircraft is within line-of-sight of the interrogator and that all ATCRBS equipment is within specifications.

It can be realized that the gains of the interrogator and transponder antennas along the line-of-sight have an important and perhaps dominant effect on the probability of obtaining a reply. In comparing the performance of a bottom antenna with that of both antennas being switched, one is hopefully comparing simply the efficacy of two antenna patterns. To do this, one must hold other parameters constant.

Although it is clear that any standard airborne antenna can be shadowed by the aircraft itself, and one can predict the conditions under which this occurs, a convincing demonstration of the effect of the lobing switch demands gathering individual replies and correlating their number and spacing with dwell time on the unshadowed antenna. The hit by hit data also provide infor-

mation in the following areas: round reliability in each mode, run length, processor reliability, and presence of synchronous garble.

Extraction of individual replies from the ARTS III is facilitated by an extractor routine which can be loaded in with other operational programs and enabled at any desired time whereafter it causes all beacon replies to be stored on magnetic tape. Those sites having the Uniservo VIC magnetic tape units are preferred for this purpose because the data can be recorded at a higher density and one tape can be in standby while another is recording.

The PCD has no provision for extracting individual replies; its only output is in the form of target declarations, which are displayed on an attached PPI console, the RAPPI, and can also be recorded on an FR-1800 tape recorder at the ARTCC [8]. Schemes used to obtain hit counts include recording the video input to the PCD, counting the output pulses from a decoder with a passive select mode, and photographing the expanded PPI displaying hits for a selected code.

B. Techniques for Data Gathering

One of the more serious handicaps under which the tests were performed was the absence of means for independently determining at any given instant what an aircraft was doing and which antenna had been selected. However, the effect of this handicap was mitigated by: (a) careful briefing of the pilots; (b) written instructions with the flight plans; and (c) coordination on a continuous basis by a Laboratory representative with the air traffic controller handling the aircraft. Thus the pilot was to inform the controller when changing antenna selection, when initiating, and again when completing turns at a particular location. As a radio frequency could not be set aside for most of

these tests, communication with the aircraft was generally through the controller. Although peak traffic hours were avoided, the work load carried by the controllers did not permit them to give special treatment to the test aircraft. Furthermore, when crossing sector boundaries aircraft are handed off to another controller who would normally give them new and nondiscrete codes. Therefore, it was necessary to have a team member in the IFR room to ensure proper handling of the test aircraft.

(1) Terminal Area. The ability to extract replies on-line from the ARTS III has already been mentioned. A data reduction program can then be employed off-line to edit the data, e.g., to print out and plot the track for a specified discrete code, as shown in Figure 2. Furthermore, as the individual replies are similarly accessible, it is possible to discern broken, serrated, or chopped targets and to check the target declaration logic.

(2) En Route. The absence of any provision for extracting individual replies from the PCD necessitated devising other approaches to acquiring data that would validate or reject targets "lost" in the recording of the output of the digitizer. As shown in Figure 3, an FR-1800 is employed for this recording which is then played back, in real time, to make a PECO tape which is then processed in the IBM 9020 to furnish a printout listing target declarations scan by scan. Up to five separate codes can be extracted in one pass, and an FR-1800 tape contains approximately four hours' worth of data. When operating properly, a data reduction computer routine, COMDIG [8], provides a quick and reliable source of information on lost targets. At times, unfortunately, it has been shown that targets which were declared by the PCD may be lost in the subsequent transmission to the FR-1800 or in the computer processing.

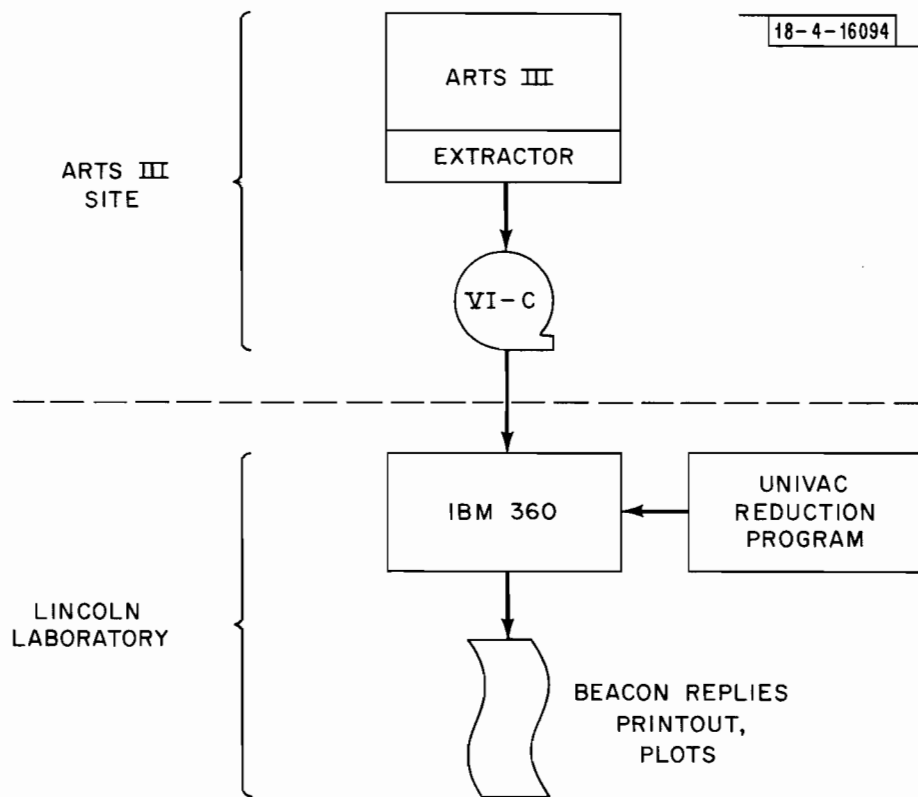

Fig. 2. ARTS III data flow.

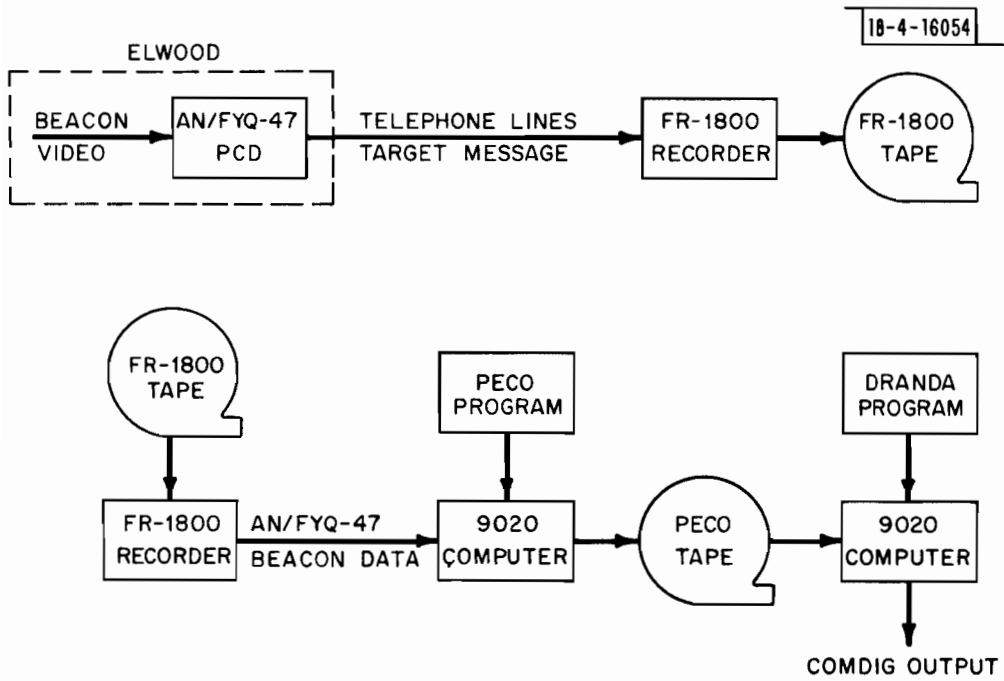

Fig. 3. Data flow from the PCD.

Recording all beacon video on an FR-950 is the most complete procedure for it permits both repetitive replay through the PCD or processing through the MLQ and IBM 7090. Output of the latter is in the form of a three-dimensional picture of a specified range-azimuth window showing each beacon reply, quantized in 1/4 mile segments in range. Although the range resolution does not permit decoding, it does contain enough detail to show which replies are mode 3/A and which are mode C. Of course, a potentially garbled situation is also easy to detect as are broken, serrated, or chopped targets. Disadvantages of the FR-950 include the need for constant attention while it is recording and while it is played back, the short running time - 25 minutes per tape - and the substantial amount of computer time needed to process the data. It is, therefore, costly to employ the wide-bandwidth recorder to cover more than a minor fraction of test flights.

At the other extreme of sophistication are two simple techniques for recording mode 3/A hits in a discrete code. One is to photograph the PPI continuously with the 0-15 35-mm camera, expanding the display to permit resolving the individual hits, as employed by Blazej [6]. The other is to record output pulses from the GPA-122 Coder-Decoder [9] operating in a passive select mode. Both techniques require inserting the discrete code of the test aircraft. If the reply code is in error in any way, the return is lost and interpretation is impossible. Expanding the PPI limits the area that can be covered, unless the origin is changed periodically; hence, the scope camera was devoted, as was the FR-950, to ensure collecting data at the locations where aircraft were to make series of 360° turns.

The Coder-Decoder was employed at Elwood, as shown in Figure 4, where it was slaved to the ATCBI-3 rather than being used to generate the mode triggers as would ordinarily be done. This abnormal type of operation apparently hindered use of the output, jack J14, and it was necessary to go into the decoder and tap off pin 31 on board 1A13, Figure 5, in order to obtain the desired passive stretch output. A VR3300 tape recorder, running at 30 ips, recorded these pulses together with IRIG time and the north pulse, as shown in the block diagram of Figure 4. Data were recovered by playing back and recording on a Honeywell model 1108 visicorder, with about a 1 KHz response.

Originally intended only to provide some quick-look data, the RAPPI proved invaluable as an active decoder and a source of target reports to replace those lost in COMDIG processing. However, keeping the track symbol on a fast-moving target is difficult and, in the busy environment prevailing on the east coast, when a target faded the RAPPI operator was sometimes misled to another aircraft nearby. Thus a genuinely lost target might lead to several RAPPI misses before the operator was able to sort out the target of interest.

The data gathered in the En Route tests, then, were of three kinds:

- (1) Spatial presentation of the full video.
- (2) Target reports, from COMDIG and the RAPPI.
- (3) Hit counts, from scope photos and decoder output.

C. Selection of Sites

Prior to development of a test plan, it was generally assumed that the tests would be conducted at an ARTS III and an ARTCC that were in the shakedown phase. In fact, Jacksonville was accepted as the Center of choice

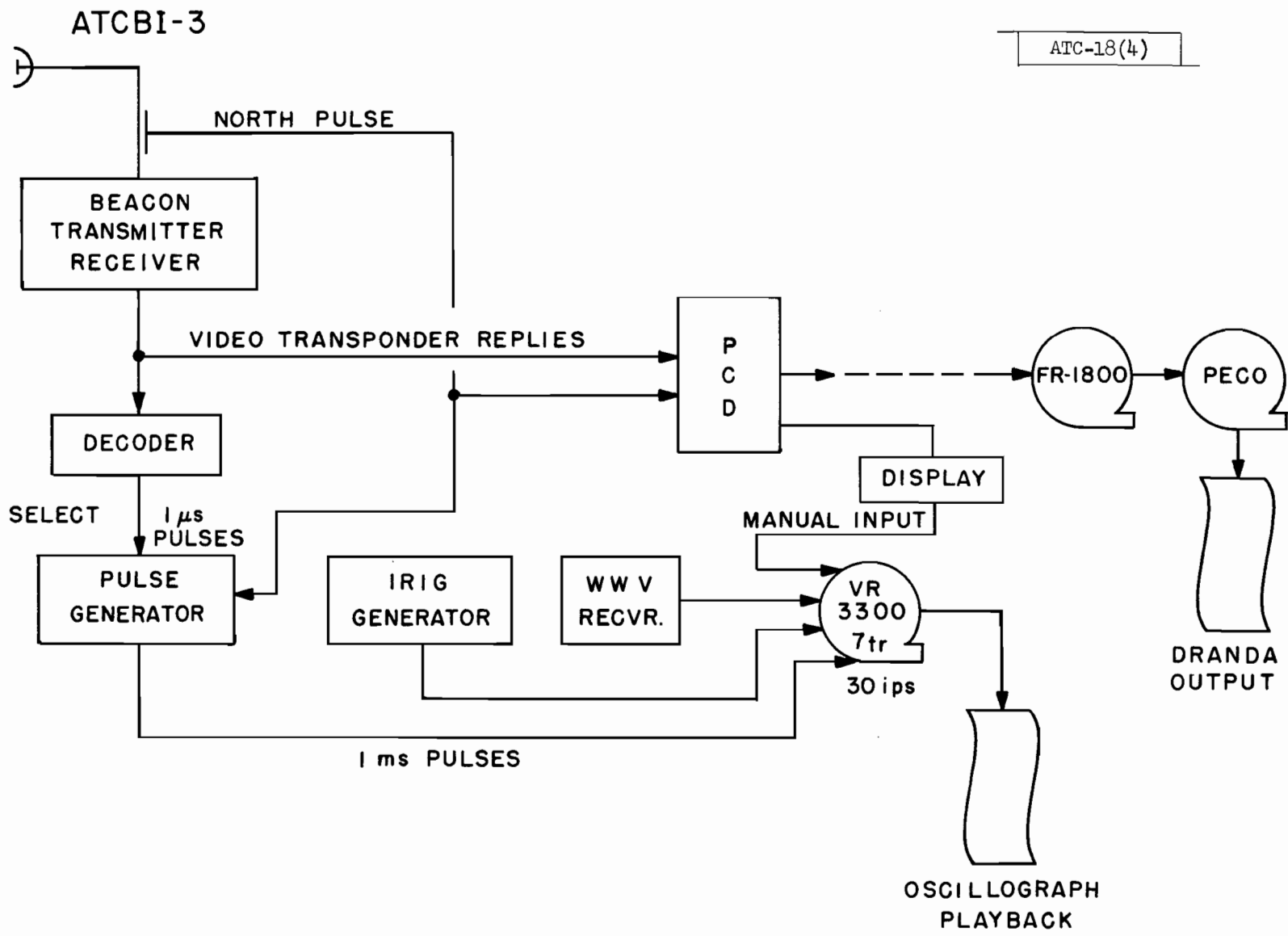

Fig. 4. Decoder-recorder system for recording beacon hits.

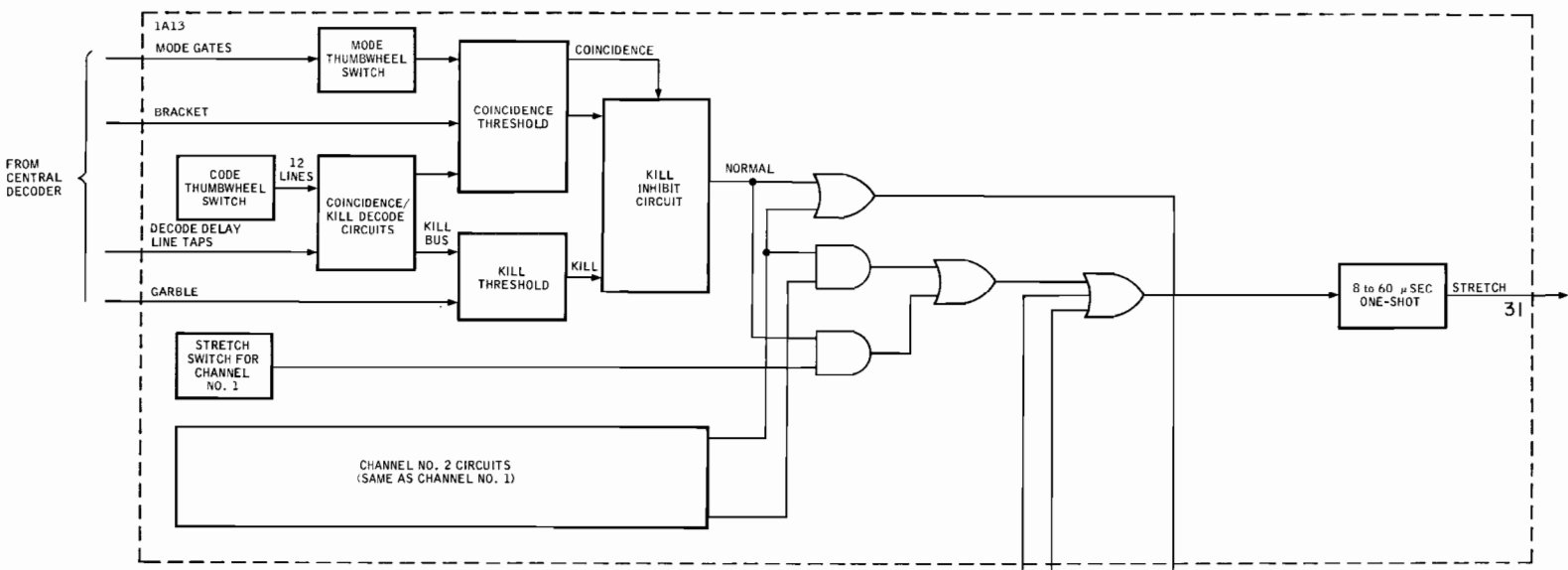

Fig. 5. Test point employed in extracting beacon reply pulses.

and Miami was considered a suitable airport for adjunct tests of ARTS III. Further consideration of the need for having confidence in the data and a better realization of the support requirements indicated the desirability of utilizing an operational ARTS III with the additional peripheral equipment and of conducting the En Route tests at NAFEC.

Availability at NAFEC of an FR-950 wide-bandwidth tape recorder, the multi-level quantizer, and computer programs for reducing the data on the IBM 7090 computer was a strong inducement to use Elwood as the site for gathering En Route data. Other resources in the form of equipment and expertise for scope photography and for passive decoding were additional advantages, as was the old Atlantic City airport and the NAFEC radar approach controllers for executing missed approaches, etc.

The PCD at Elwood is an FYQ-47, although it differs in some minor details from those in operation at joint USAF-FAA sites. During the tests, it and the associated RCU, the telephone and microwave links, modems, and the ATCBI-3B, were operated under standard conditions as though the data were going to an ARTCC rather than to NAFEC. The transmitter was operating at 1.5 kW, the receiver sensitivity was -88 dBm. Settings in the PCD were 6 for T_L , 2 for T_T , and 5 for T_V . Although the telephone lines were checked out before the tests, on a weekly basis, one of them was found later to have been faulty and to have seriously degraded the data gathered on the first day. These data had to be heavily edited and some discarded.

Washington National Airport was selected for gathering ARTS III data for the following reasons:

- (1) Availability of Uniservo VI C magnetic tape units.
- (2) Availability of operationally tested extractor programs.
- (3) Nearness of Andrews AFB, location of an ATCBI that fed data to DCA, as a source of a variety of military aircraft and as a location for performing repeated missed approaches.

The proximity of NAFEC and DCA lent further weight to the selection of both as it would permit joint tests in a single aircraft mission.

In order to demonstrate data gathering techniques in a busy environment, to exercise the logistics of aircraft support, and to evaluate proposed flight profiles, preliminary tests were conducted at Washington National Airport and at NAFEC. A T-39 flight was provided through Headquarters Command for the former and two F-106's from ADC and an EC-121 from NRL for the latter. The success of these preliminary tests was one of the factors affecting final selection of those locations for the full-scale tests.

D. Selection of Aircraft Types

In the course of evolving a test plan, several meetings with representatives of FAA (OP-4 and RD-240), NRL, AFESD, and others were held which resulted in limiting the experiments to aircraft permitting a comparison of the performances of essentially two antenna configurations; viz. bottom antenna only and both antennas with the lobing switch. For aircraft in which additional options were readily available, they were also to be exercised if time permitted.

As a guide to the types of aircraft of greatest interest, the results of Rubinger's analysis [1] of the 1971 Controllers Survey was employed and the 20 most troublesome types were ranked in the order shown in Table III.

Table III. Military Aircraft Causing Problems in Air Traffic Control.

<u>Deficiency Rank</u>	<u>Type</u>	<u>Antenna</u>
1	T-38	Bottom
2	A-4	Switched
3	F-4	Top
4	T-29	All
5	C-141	All
6	T-37	All
7	T-39	All
8	T-33	All
9	B-52	All
10	F-106	Switched
11	C-135	All
12	C-130	All
13	F-8	Top
14	A-7	Top
15	C-118	All
16	A-6	Top
17	B-57	All
18	C-131	All
19	C-124	All
20	F-111	All

They were then screened for presence of the lobing switch and for availability. Essentially all of the USAF aircraft listed are equipped with the SA-1474/A solid state switch. Most of them also have a selector switch in the cockpit perimitting a choice of bottom, top, or switched and thus are listed as "all" for antenna configuration.

Because of the manner in which data on military aircraft were gathered, the Controllers' Survey gives undue weight to aircraft types having large populations. Thus, the T-38, which exists in relatively large numbers, is not necessarily the worst performer.

The SA-1474/A solid-state lobing switch was developed to provide a higher reliability at the 38 Hz cycling rate than was feasible with a mechanical switch. Although the switching rate may be adjusted over the range 10 to 1000 Hz, it is normally set at $38 \pm 10\%$ with a maximum transition time of 25 μ sec and a dwell time difference less than 0.5%. Insertion loss is less than 0.5 dB and the power rating is 2.5 kW at a duty factor of 0.01.

A mechanical switch, Transco type CS-432A, is still in use on some USN aircraft. It operates at a rate of 20 ± 3 Hz, in a make-before-break fashion and apart from a slower action it meets specifications similar to those for the solid state switch.

Sources of Aircraft

Proximity of Air Force and Naval Air bases to Washington National Airport and to NAFEC greatly facilitated obtaining test flights and rendered these efficient in terms of the ratio of useful to total flying time. Of the types which were considered potential candidates the following are based in the region of interest:

At Andrews AFB: C-130, C-135, F-8, F-105, T-29, T-33, T-39

At Dover AFB: C-5A, C-141, F-106

At McGuire AFB: C-141, F-105, KC-135

At Patuxent R. NAS: A-4, A-7, C-1, C-2, S-2.

The roster of aircraft actually employed was dictated largely by their availability at short notice and, for the Air Force, the possibility of accomplishing a training mission in conjunction with a test flight. They may be categorized as trainers, interceptors, tactical bombers, transports, and ASW.

(1) Trainers. These are well represented among aircraft types in the Controllers Survey, viz., five out of the top eight, hence it is fortunate that both the T-29 and T-39 could be included in the tests, through the cooperation of the 1st Composite Wing, Headquarters Command, at Andrews AFB.

The T-29 is a military version of the twin-engine Convair 240/340 Series and is employed for aircrew training. Maximum takeoff weight is 44,000 lb, initial rate of climb 1370 ft/min, service ceiling 24,000 ft, and maximum speed 300 mph. This aircraft ranks fifth in the Controllers Survey of military aircraft exhibiting beacon tracking deficiencies.

A T-29 was provided by the 2nd Composite Squadron at Andrews AFB through the cooperation of L/Col. E. E. Layer, Operations Officer of the Composite Wing. It was equipped with the AN/APX-72 transponder, the SA-1474/A switch and a cockpit selector switch. The upper blade antenna is located on the top center line approximately above the cabin forward bulkhead whereas the lower blade antenna is located on the bottom center line just aft of the wing root.

This particular aircraft was incapable of climbing, at a reasonable rate, above 16,000 ft; hence, the initial orbits for the En Route tests were performed near the Cape Charles VORTAC, at a distance of 145 miles from Elwood, rather than at Norfolk.

The North American Rockwell Sabreliner is a twin-jet, swept-wing aircraft employed by the U.S. Navy and Air Force as a combat-readiness trainer and utility aircraft under the designation T-39. It has a maximum takeoff weight of approximately 20,000 lb, a maximum rate of climb at sea level of 5,000 ft/min, and cruises at Mach 0.8. Among military aircraft that are known to have made problems for air traffic controllers, the T-39 ranks seventh.

The aircraft employed in this test was provided by the 1st Composite Squadron (Jet) at Andrews Air Force Base. It was equipped with the AN/APX-72 transponder, the SA-1474/A switch, and a selector in the cockpit. The upper blade antenna is located on the top center line forward of the cockpit; the lower blade antenna is located on the bottom center line just aft of the wing root.

Antenna radiation patterns, measured by Lockheed-Georgia on a 1/15th scale model, indicate that coverage in the forward hemisphere is good with either antenna. In a rearward direction, however, the canopy and the aft fuselage block radiation from the top and bottom antennas, respectively, in a relatively small solid angle.

(2) Interceptors. The General Dynamics/Convair F-106 Delta Dart is the principal all-weather supersonic fighter interceptor of the Aerospace Defense Command. It has a maximum takeoff weight of ~35,000 lb, a

range of 1,500 miles, a service ceiling in excess of 50,000 ft, and a speed > Mach 2.0. The F-106 is of special interest because it is the only modern fighter interceptor in operational use by the U.S. Air Force and it has been the subject of several previous investigations, including one conducted by ESD [10].

Flush-mounted IFF antennas are located on the fuselage; the top one is on the center line forward of the canopy, the bottom one is on the bottom center line just aft of the missile bay. Wing-tip tanks of 100-gallon capacity each, which are part of the normal configuration, are aft of the lower antenna.

A total of four sorties was provided through the cooperation of the 95th Fighter Interceptor Squadron, Dover Air Force Base; the first two being preliminary tests of data gathering at NAFEC. As this aircraft is not furnished with a cockpit selector, two aircraft were flown; one with the lobing switch, the other with the bottom antenna connected directly to the transponder.

(3) Tactical Bombers. The A-4 is one of the few U.S. Navy aircraft having the lobing switch. It is number 2 in the Controllers Survey.

The Douglas Skyhawk is a single-seat lightweight attack bomber in operational use with the U.S. Navy, which has more than 500 in active service. It has a maximum takeoff weight of 24,000 lb and a maximum speed of 680 mph.

The A-4 employed in these tests was provided by the Test and Evaluation Coordinator at the Patuxent River Naval Air Station, Cmdr. Richard Belmore. It was equipped with the AN/APX-72 and the Transco CS-432A lobing switch, but did not have a selector switch in the cockpit. Consequently, it was necessary for the pilot to return to Patuxent River NAS, after flying with one antenna configuration to have the alternate connection made. The

two options requested were: (a) bottom antenna only, (b) switched antennas. The top antenna is located on the top center line, near the nose, whereas the bottom antenna is located on the bottom center line, under the tail.

The Republic Thunderchief F-105 is a single-seat supersonic tactical fighter-bomber with a maximum takeoff weight of 52,500 lb, a maximum level speed of Mach 1.2 at sea level, Mach 2.2 at 38,000 ft.

The test aircraft was supplied by the ANG 121st Tactical Fighter Squadron of the 113th Tactical Fighter Wing through the cooperation of L/Cols. Ehrlich and Kennedy. It was equipped with the AN/APX-72 transponder and the SA-1474/A lobing switch. The aircraft also carried the customary two 450-gallon fuel tanks on inboard pylons. The transponder upper flush antenna is located on the fuselage center line approximately seven feet from the nose; the lower blade antenna is on the fuselage center line some 48 feet from the nose. From the side, the lower antenna is shadowed by the wing tanks.

The F-105 does not appear among the first 20 military aircraft types causing air traffic control problems.

(4) Transports. The Lockheed C-141 is a four-engine, long-range transport comprising some 80% of the airlift capability for MAC. At a maximum takeoff weight of 385,000 lb, the aircraft carries a load of 110,000 lb for a 3550 nmi mission at a cruise speed of Mach 0.825.

For the test flight an aircraft was provided at short notice by a reserve group associated with the 438th Military Airlift Wing, McGuire AFB, through the cooperation of Maj. Dean Hess, Director of Training.

The aircraft was equipped with the AN/APX-64 transponder and the SA-1474/A switch. The top blade antenna is on the fuselage center line just aft of the cockpit whereas the bottom flush antenna is on the fuselage center line some 20 ft farther aft.

(5) Anti-Submarine Warfare. The Grumman C-1 is actually a transport-trainer version of the S-2 anti-submarine search and attack aircraft, a twin-engine high-wing monoplane. The S-2 has a maximum takeoff weight of 26,000 lb, a maximum speed of 280 mph and a service ceiling of 22,000 ft. For the normal patrol mission at 1,500 ft and 150 mph, endurance is nine hours.

E. Flight Profiles

It has already been suggested that knowledge of radiation patterns for airborne transponder antennas should permit a reasonably accurate prediction of aspect angles where shadowing will occur. Conversely, conditions under which an antenna will be in view of the interrogator are also predictable. It can be safely assumed that in straight and level flight with no line-of-sight obstructions, a bottom antenna would provide a detection probability close to 100 per cent. In fact, it is conceivable that an aircraft would provide a good beacon target at each instant throughout an entire flight. In order to gather statistically significant data on lost targets, without requiring inordinately long test periods, it is clearly necessary to emphasize maneuvers expected to contribute to lost targets. Thus the flight profile was designed to exercise a variety of reasonable maneuvers in order to provide data permitting a comparison of antennas and of aircraft, rather than to simulate a typical mission profile.

For the terminal area, a profile shown in Figure 6 was designed to include a number of 360° turns at 16,000 ft and at two azimuths 90° apart and at a range of approximately 40 nmi. They were to be followed by a high altitude penetration, for the higher performance types, to Andrews AFB, (ADW) a standard missed approach, climbout to $\sim 9,000$ ft and a second penetration. Several 360° constant bank angle turns were to be executed at each location with each antenna configuration. The initial climbout and the first penetration were to be performed with one antenna configuration; the second with another, and so forth. To facilitate position keeping, the orbits were to be made over the VORTAC's at Patuxent River (PXT) and at Brooke (BRV), which are the standard I.A.F.s for high altitude penetrations to ADW runway 1L.

The proposed flight profile was coordinated with the chief controllers at Andrews AFB, at Washington National Airport and at Washington Center and with operations officers of several Air Force units at Andrews. Some flexibility was accepted to accommodate the different types of aircraft, different air traffic conditions, etc.

For the En Route tests, the profile, as shown in Figure 7, was designed to provide data near the maximum range, at an intermediate range, and in a climbout; thus, the endurance of the smaller aircraft was pushed to the limit. Initial orbits were to be performed over the Norfolk VORTAC (ORF) at ~ 175 nmi, a second series over the Salisbury VORTAC (SBY) at ~ 80 nmi, followed by penetrations off Sea Isle (SIE) to Atlantic City (ACY) Runway 13, followed by a climbout on ACY R-145 to present a tail-on aspect to the Elwood radar.

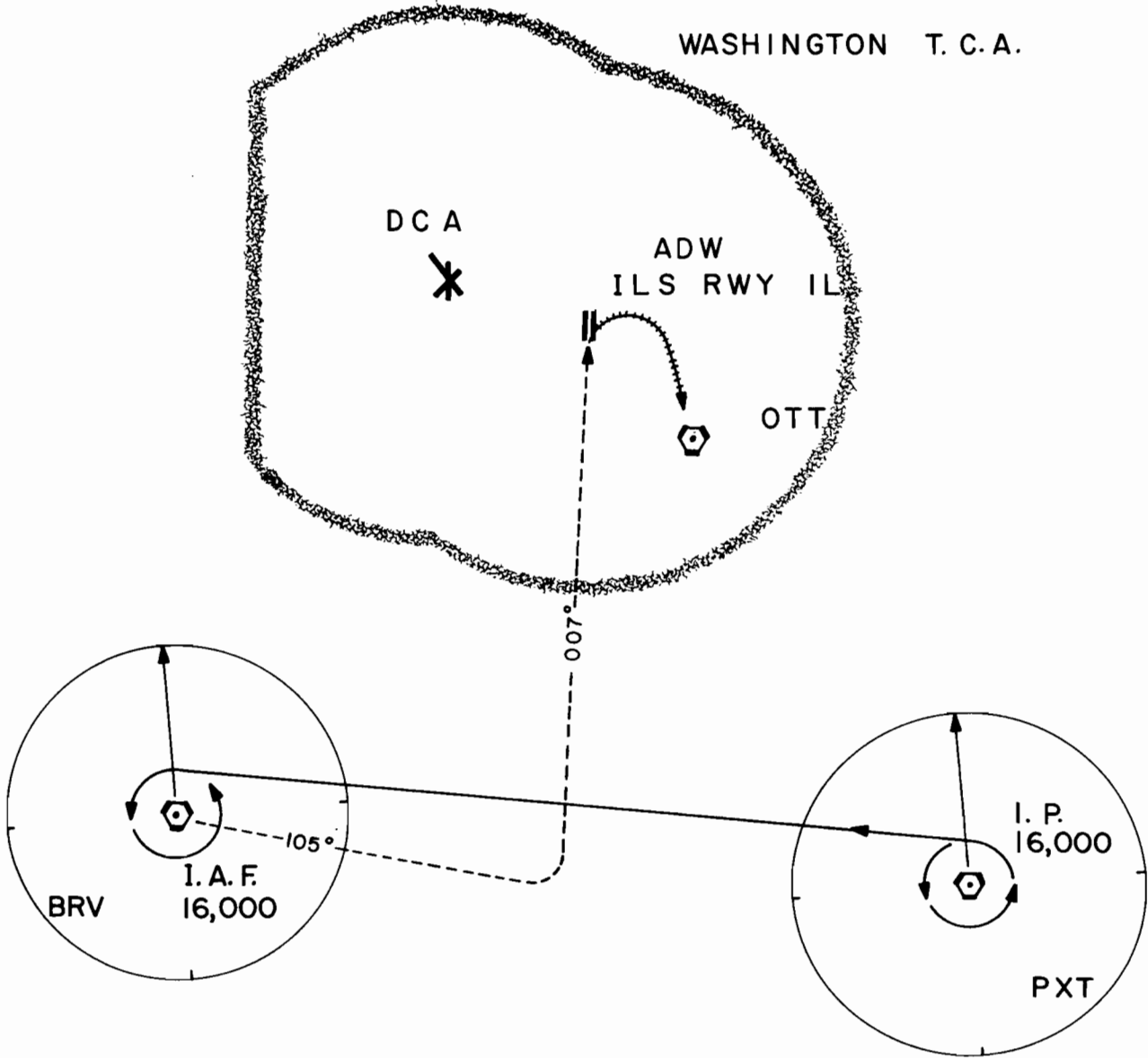

Fig. 6. Profile for test flight against ARTS III at Washington National Airport.

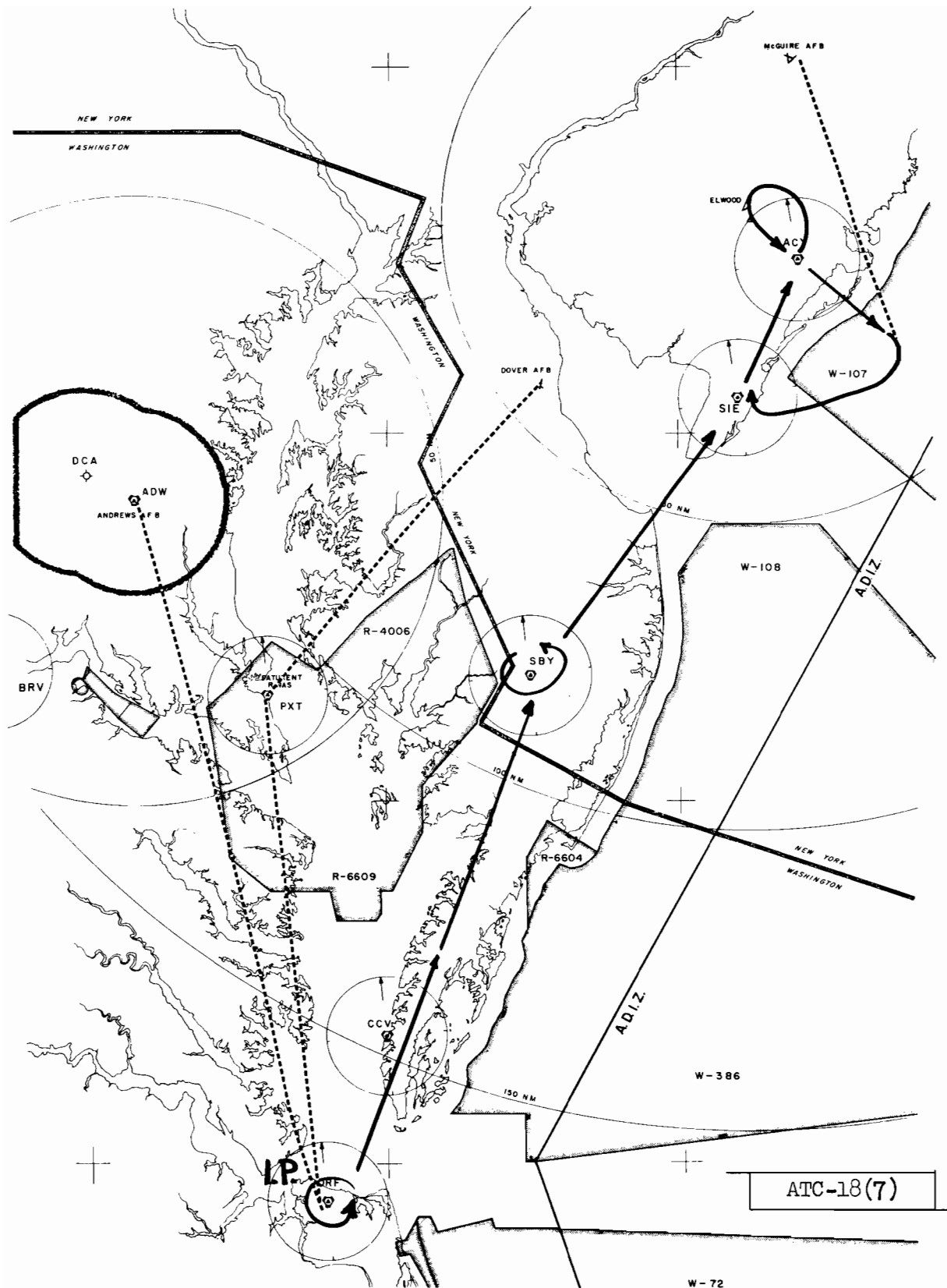

Fig. 7. General plan for en route tests against the Elwood site.

Because of the possibility that the results of the tests could be affected by structure in the pattern of the ATCBI antenna, the elevation angles from Elwood at which test aircraft would be seen are plotted in Figure 8. These were calculated by assuming a $4/3$ earth radius and the horizon location appears to have been verified, within $\sim \pm 0.05^\circ$, by correlation with first detections. To a crude approximation, lobes at 0.5° and 1° with a null between could be expected and it is seen, by reference to the graph, that aircraft flew through this region en route from ORF to SBY. Data pertaining to 360° turns are generally limited to elevation angles between 0.25° and 2.75° , and to azimuths between 205° and 215° .

For some of the test flights in the Washington terminal area, En Route data were collected at Bedford, Cape Charles, and Suitland but as they were not gathered under controlled conditions they are not included with that collected at Elwood. On the other hand, because of their usefulness in evaluating the effect of different mode interlaces, the data have been analyzed and are included as Appendix B.

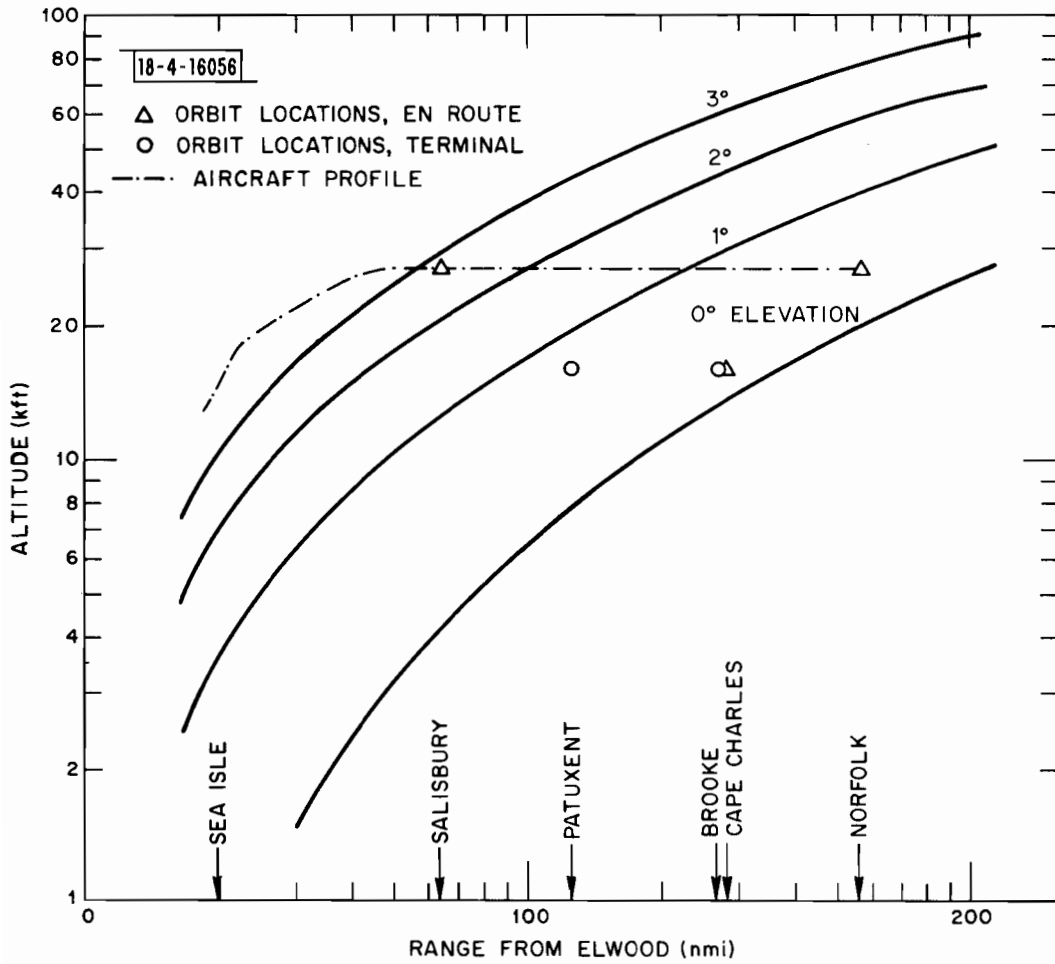

Fig. 8. Elevation angles from Elwood.

III. RESULTS

A. Test Flight Operations

A synopsis of all flights for this project is arranged chronologically in Table IV. The first four were those involved in preliminary tests, although the data collected at DCA on the T-39 were considered adequate and no additional terminal area test of that aircraft was carried out.

The flight profiles employed in the terminal and En Route tests were designed to meet the following requirements:

- (a) To be non-variant with aircraft type.
- (b) To permit observations of antenna performance over the widest possible range of aspect angles.
- (c) To permit a statistically significant number of scans while in turns.
- (d) To permit collecting data over the full normal detection range.

The profiles were also designed to cause the least disruption of normal air traffic control procedures and to be acceptable to pilots and training officers.

In order to facilitate extracting and reducing data for each test aircraft, a requirement for allocation of a discrete code, and its retention throughout the test flight, was laid down. When this would be infeasible, it was stipulated that the last two digits of the code were to remain unchanged.

Table IV. Synopsis of Test Flights.

<u>TYPE</u>	<u>DATE</u>	<u>SOURCE</u>	<u>LOCATION</u>	<u>DURATION</u>	<u>DATA COLLECTED</u>
T-39	7-25	1st Comp	DCA	2.7 (Hrs)	ARTS III
F-106	8-8	95th FIS	NAFEC	1.6	DRANDA
F-106	8-8	95th FIS	NAFEC	1.6	DRANDA
EC-121	8-9	NRL	NAFEC	2.5	DRANDA, FR-950, Photos
T-29	10-25	2nd Comp	DCA	2.0	ARTS III, DRANDA*
C-1	10-26	NATC	DCA	3.2	ARTS III, DRANDA*
A-4	10-27	NATC	DCA	1.2	ARTS III, DRANDA*
F-105	11-2	113th TAC FS	DCA	1.5	ARTS III
A-4	11-3	NATC	DCA	1.2	ARTS III
F-106	11-15	95th FIS	DCA-NAFEC	1.7	ARTS III, DRANDA, FR-950, Photos
F-106	11-15	95th FIS	DCA-NAFEC	2.0	ARTS III, DRANDA, FR-950, Photos
F-105	11-15	113th TAC FS	NAFEC	Aborted	
T-39	11-16	1st Comp	NAFEC	2.5	DRANDA, FR-950, Photos, DR ⁺
T-29	11-16	2nd Comp	NAFEC	1.2	DRANDA, FR-950, Photos, DR ⁺
A-4	11-16	NATC	NAFEC	1.2	DRANDA, FR-950, Photos, DR ⁺
A-4	11-16	NATC	NAFEC	1.2	DRANDA, FR-950, Photos, DR ⁺
C-141	11-17	93rd MAW	DCA-NAFEC	4.0	ARTS III, DRANDA, FR-950, Photos, DR ⁺
F-105	11-17	113th TAC FS	NAFEC	1.5	DRANDA, FR-950, Photos, DR ⁺

*Limited data from Washington Center

+Hit counts by decoder recording

1. ARTS III Flight Profile. In a preliminary test in the Washington TCA, a flight plan was adopted that included a standard holding pattern, a high altitude penetration to Andrews, missed approach and return to the initial point. The entire profile was repeated with a different antenna configuration until all three, on a T-39, had been exercised. The total testing consumed approximately 2.5 hours but included only three orbits. Because many of the candidate aircraft had less endurance than the T-39, because more data collected in turns were deemed necessary, and because it was also believed important to collect data in turns at different azimuths, the final plan could be flown only once. The initial point was the Patuxent VORTAC, at 16,000 ft, where at least two, and preferably four, orbits with each antenna configuration were performed at a constant bank angle. A bank angle typical for the aircraft was chosen, ranging from 30° for the T-29 to 60° for the F-106. Thus, for the slower aircraft a 360° turn would take approximately two minutes and provide for 30 scans by the interrogator. After their completion, the aircraft was flown west to the Brooke VORTAC where the turns were repeated. In each series, the sequence of antenna selection was always bottom, switched, and top. After completion of the second series of turns, the pilot began his approach to Andrews, the route and profile for which would depend on the current operating conditions and the type of aircraft. A high altitude penetration to ADW 1L, using BRV as initial approach fix, was preferred. After making a low pass, the pilot then turned to Nottingham VORTAC in a standard missed approach. Traffic conditions permitting, he was then directed to PXT at 9,000 ft for a second approach utilizing an alternate antenna configuration. The written flight plan that

was handed to operations officers, controllers, and others contained slight variations dictated by the aircraft type and origin but was generally of the following form:

After departing Andrews terminal area, with bottom antenna selected, squawk assigned code in mode 3/A with altitude reporting (mode C). Contact Washington National Airport on assigned frequency.

Proceed direct to Patuxent River VORTAC at 16,000 and execute two 360° left turns; select both antennas and execute two additional left turns, finally select top antenna and repeat two turns all at a bank angle of 30°.

With bottom antenna selected, proceed as directed to Brooke VORTAC at 16,000 and repeat the 360° left turns, first with bottom then with both antennas, finally with the top (two turns with each).

Selecting both antennas, with Brooke as IAF (if south operation, Nottingham is IAF), execute a high altitude penetration to Andrews HI-ILS Runway IL, squawking low at ADW 10 DME. Descend to 750 and execute a missed approach at the MAP, turning right to 4,000 direct to Nottingham VORTAC, or as directed. Change to bottom antenna and, squawking normal power, proceed to Patuxent at 16,000. Using PXT as IAF, if north operation, execute a second high altitude penetration to Andrews HI-ILS Runway IL, squawking low at ADW 10 DME.

2. En Route Flight Profile. The two principal locations for orbits in the En Route tests were the VORTACs at Norfolk (ORF) and Salisbury (SBY), at 175 and 80 nmi distance, respectively, from the Elwood site. Aircraft from Andrews, Dover, or Patuxent River were to utilize ORF as an initial point at a minimum altitude of 27,000 ft, with the exception of the T-29 which utilized Cape Charles (CCV) at 16,000 ft. A series of 360° turns was to be made at ORF and SBY, or at CCV, similar to those performed in the terminal area. The flight plan specified which antenna was to be selected for each leg of the flight and these were alternately bottom and both. From SBY the aircraft were to proceed to Sea Isle (SIE) for the approach to Atlantic

City (ACY) Runway 13. The standard approach is a descent from SIE to ACY and a turn to the NW before lining up with the runway. This permits a radial path from Elwood and observations of the aircraft from tail-on aspect during the climbout. Aircraft were to climb to 9,000 ft in warning area W-107 before turning to SIE for a second approach.

For En Route test flights, the flight plan was generally of the following form --this particular one was specifically prepared for the T-39:

After departing Andrews terminal area, with both antennas selected, contact Washington Center and squawk assigned discrete code in mode 3/A, with altitude reporting (mode C). A climbout at maximum rate of climb to 9,000 may be requested. Proceed to Norfolk VORTAC at FL-270 or above and execute twelve 360° left turns, at 30° - 45° bank angle, as follows: four with bottom antenna, four with both, four with top. Report to Washington Center when beginning first turn and when completing the last. With bottom antenna selected, proceed to Salisbury VORTAC and repeat the twelve 360° turns in the same order; viz., bottom, both, top, reporting to New York Center their initiation and completion.

Selecting both antennas, proceed to Sea Isle VORTAC and Atlantic City R-215, 24 DME at 14,000, the IAF for a high-altitude penetration to HI - VORTAC RWY 13. Squawk low at 10 DME. Descend to a minimum altitude of 1500 + 500 for a missed approach at the MAP, turning to R-155 and climbing out at maximum rate of climb to 10,000 at 30 DME in W-107, squawking normal at 10 DME. Selecting the bottom antenna, turn to SIE R-105, climbing to 14,000 at the IAF for a second high-altitude penetration to HI - VORTAC ACY RWY 13. Squawking low at ACY 10 DME, descend to a minimum altitude of 1500 + 500 for a missed approach at the MAP, turning to R-155 and climbing out at maximum rate of climb to 10,000 at 30 DME in W-107, squawking normal at 10 DME.

Selecting both antennas and climbing to 16,000 or higher, turn to CYN R-175 to intercept MIV R-070. Proceed via Kenton VORTAC back to Andrews.

The last paragraph describes a tentative route for bringing the aircraft around to the north and then directly over the radar at Elwood.

B. ARTS III Data

The results of the tests are summarized below for each aircraft type tested. A listing of lost targets for each aircraft, including reply pattern, time, transponder antenna selection, maneuver, and aircraft position is given in Appendix A. To reduce the effect of variables other than antenna selection on the results to a minimum, "misses" were not included if examination of the sweep-by-sweep data indicated the target was declared, but with an incorrect code, or was not declared solely due to azimuthal abutment* or range overlap† of replies from other aircraft. Target miss rates are summarized in Figures 9a, b, c, d. However, in some cases not enough data are available to ensure a high statistical significance. The results summarized in Section IV include only those cases where 85% statistical significance can be assured. In comparing the performance of both antennas switching vs the bottom antenna, the sequences of consecutive lost targets were considered in addition to a simple comparison of percentages of lost targets. (In general, lost targets are more tolerable if they are not consecutive.) As an estimate of the worst-case probability of n or more consecutive misses occurring, the estimated probability of n or more consecutive misses was calculated and plotted for turns at ranges > 25 nmi. These plots were used as the primary measure of each antenna configurations' performance. In those cases in which this measure indicated no preference for either antenna configuration, azimuth jitter, and data from other flight regimes were used as a secondary criterion of performance. Figure 10 summarizes the azimuth jitter for the several cases.

* Causing merging of two targets into one.

† Causing synchronous garbling of codes.

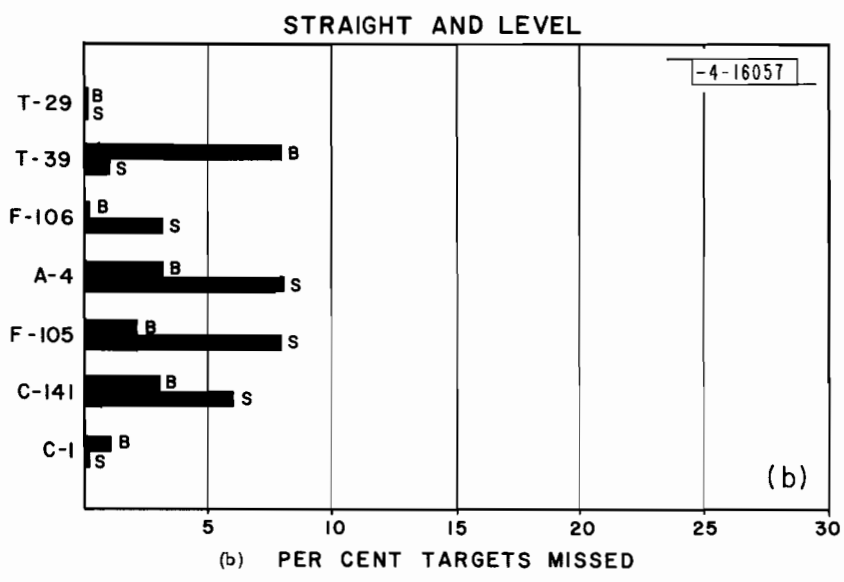
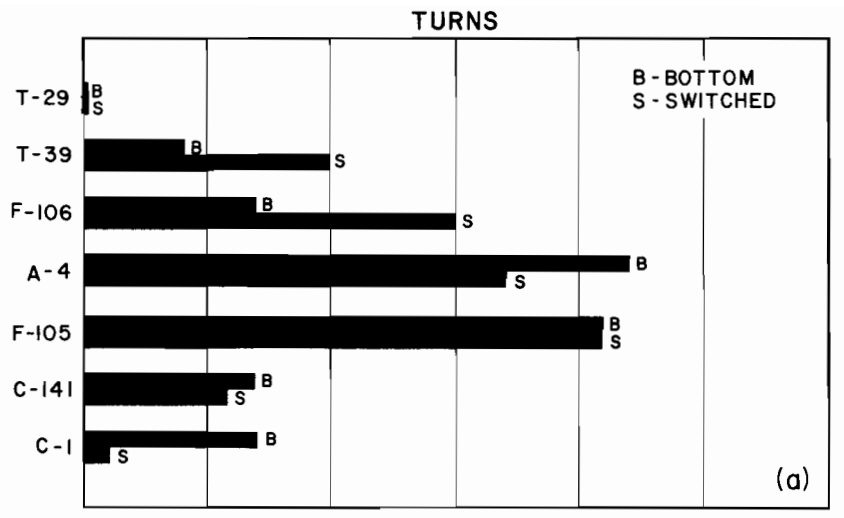

Fig. 9. Target miss rate summary.

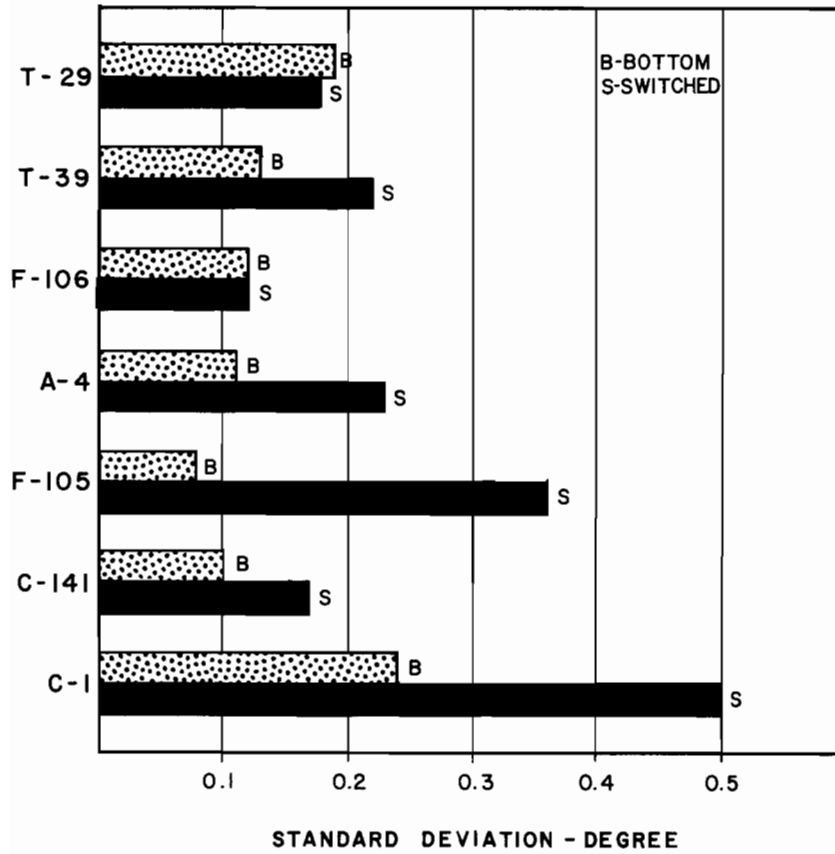

Fig. 9. Continued.

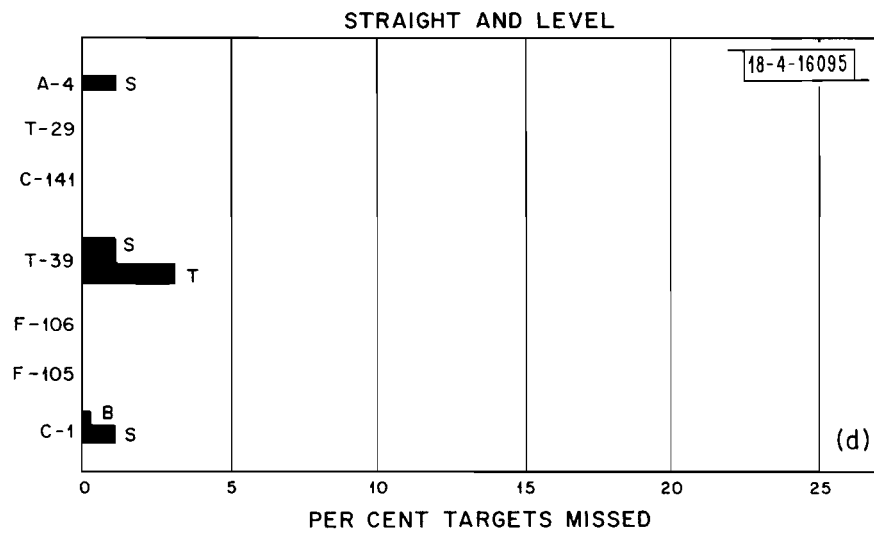
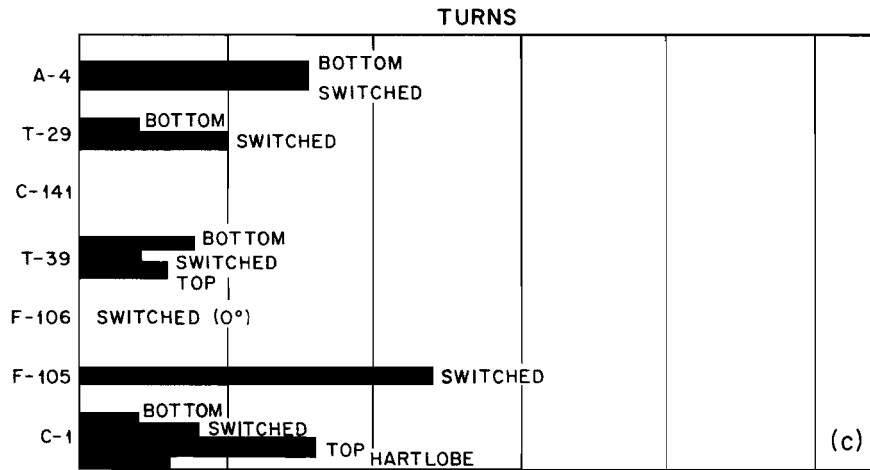

Fig. 10. Azimuth jitter.

To estimate the uncertainty in reported azimuth (azimuth jitter), least-squares circles were fitted to portions of turns and used to estimate the variance of azimuth measurements. For the switched antennas, segments of the turns during which one antenna was shielded were used, in order to obtain a worst-case estimate of the increase in azimuth uncertainty. As noted earlier, the uncertainty in the measurement of range would not be expected to vary as a function of antenna. Therefore, the variance of range errors was also calculated to give an estimate of the confidence that a circle was indeed being flown. Obtaining estimates of azimuth jitter due to antenna shielding from circular flight paths, rather than ascending or descending straight lines, has an inherent advantage in that the effects of extraneous variables, such as range and changes in the interrogator's vertical antenna pattern, are minimized.

T-29

Four turns were flown by the T-29 with each antenna (top, bottom, switched) over Patuxent and repeated at Brooke. The relative performance of the antenna configurations was considerably different at the two locations, as shown in Table V.

Table V. T-29 Turns at Ranges >25 nmi.

<u>Antenna Config.</u>	<u>Time (Z)</u>	<u>Scans</u>	<u>Misses</u>	<u>Location</u>
Switched	17/43/18 - 17/47/33	66	27 (41%)	Patuxent
	18/13/3 - 18/17/2	62	0 (0%)	Brooke
Bottom	17/36/21 - 17/41/28	79	4 (5%)	Patuxent
	18/8/28 - 18/12/0	55	0 (0%)	Brooke
Top	17/48/40 - 17/52/56	67	18 (27%)	Patuxent
	18/18/21 - 18/23/11	75	4 (6%)	Brooke

The disparity in performance at the two locations could be attributed to a number of causes, including:

1. Synchronous garble or azimuthal abutment with other aircraft.
2. An interruption in data recording at the ARTS III processor.
3. Differences in the aircraft antenna gain at the two locations, caused by differences in bank angle of the aircraft.
4. Transients in transponder performance.

5. Elevation or azimuthal variations in the antenna pattern of the interrogator.

As stated earlier, misses due only to synchronous garbling of replies or azimuthal abutment with another aircraft were reinstated as targets after examination of the sweep by sweep data. This explanation of the differences in performance at the two locations can be eliminated as a possibility. Similarly, track data for the T-29 during the scans of interest indicated a failure to correlate with a target during the scans in which no target was recorded, implying that data recording was not interrupted.

Plots of the T-29's position during the turns at Patuxent indicate a strong crosswind was blowing. Compensation by the pilot for wind gusts may have resulted in more frequent and complete shielding of the antenna in use. However, this single factor would seem unlikely to account for all of the difference in the switched antenna's performance at the two locations (41% missed targets vs 0%).

In investigating transients in transponder performance, two possibilities were considered: temporary disabling of the transponder, and an increase in the minimum triggering level. The possibility that the transponder was inhibited for most of the time during the turns at Patuxent seems unlikely, because sweep by sweep data show that some replies were being received. In addition, data from the ARSR radar at Suitland (40 nmi away) showed no missed targets during the time when 27 misses occurred at Patuxent, indicating that the T-29's transponder was still replying to interrogations of sufficient signal strength. The transponder in the T-29 is equipped with a switch that raises the minimum triggering level of the transponder. If this

switch had accidentally been thrown while the pilot was changing the antenna configuration, it might explain all of the data described above. However, the poor performance of the switched antennas was observed to begin some time after the reply patterns indicated antenna configuration changeover was completed, indicating that it was unlikely that the pilot accidentally bumped the low sensitivity switch while switching the antenna configuration, and later corrected his error before proceeding to Brooke.

A more likely explanation of the differences in performance at the two sites is elevation or azimuth variations in the strength of the signal from the interrogator, combined with the action of the defruiter and the existence of the threshold level in the transponder (minimum triggering level). The reply patterns when the aircraft was at Patuxent were typical of those caused by a weak RF link, supporting this hypothesis.

Plots of the T-29's reported position while in turns at Patuxent show that the crosswind caused the turns with the bottom antenna to be flown at a slightly different azimuth from that for those flown with the top or with switched antennas, suggesting the possibility that the variation in the strength of the RF link may have been azimuthal. If so, plots of individual replies indicate that the variation in signal strength was not due to a line-of-sight obstruction such as a hangar. This is supported by the Andrews AFB obstruction chart and site photographs. However, if the RF link was marginal initially, due to the threshold in the transponder, a small variation in signal strength could produce relatively large changes in the percentages of missed targets, particularly since the turns tended to keep the aircraft at that particular azimuth. This seems to present a plausible explanation.

Another possibility is that vertical lobes in the interrogator antenna pattern were responsible for the weak RF link during part of the turns at Patuxent. Unfortunately, the T-29 did not have an altitude reporting capability and data from other test aircraft at the azimuth of interest were too limited to allow an evaluation of the probability that vertical lobing was the cause of the lost targets at Patuxent. An investigation of data from the Andrews radar for other aircraft did not find evidence of significant vertical lobes in the interrogation pattern [11].

Apparent variations in performance of the switched antennas could also have been caused by inopportune switching while the aircraft was illuminated by the interrogator. If an antenna which is at least partially shielded happens to be on more often than the unshielded antenna, the probability of detecting the aircraft is decreased. Since the antenna switching is uncorrelated with the time at which illumination of the aircraft begins, the performance of the switched antenna can seem to vary significantly, if only small samples of data are considered.

In conclusion, it would appear that the anomalous performance of the T-29 at Patuxent may have been influenced by a combination of variations in the interrogator antenna pattern, the threshold logic of the transponder, and, in the case of the switched antennas, chance. The possibility that lobes in the interrogator antenna pattern might have degraded the performance of the top-only and switched antenna configurations makes suspect any comparisons between the performance of the bottom antenna and that of the top or switched antennas during the turns at Patuxent. However, since antenna patterns of the interrogator are not available, it is impossible to prove that interrogator

antenna lobes differentially influenced the test results. Due to the possibly significant influence of extraneous variables during the turns at Patuxent, data from those turns were not used in the analysis of performance. Fortunately, the turns at Brooke provide ample data for use in comparing the performance of the switched and bottom-only antennas in turns at ranges greater than 25 nmi.

Considering only the turns at Brooke, the T-29's performance in turns at ranges > 25 nmi was very good in all three configurations. As shown by Table VI, the performance of both the switched and bottom configurations was also good during straight and level flight, and during turns at ranges < 25 nmi. Some targets were missed in both bottom and switched antenna modes during turns at ranges < 25 nmi, probably partially due to the STC of the interrogator. Although the switched antennas' miss rate was higher than that of the bottom antenna during the short-range turns (5% versus 2%), the difference was not significant to 0.8 level of confidence. Since there were no missed targets in either switched or bottom modes at Brooke, there is no distribution of consecutive missed targets. The azimuth jitter was essentially identical for the two configurations (0.18° for switched versus 0.19° for bottom-only), leading to the conclusion that there was no significant difference between the performance of the switched and bottom antenna configurations for the T-29 in turns. Both configurations performed very well.

Table VI. T-29.

<u>Range > 25 nmi</u>		
	<u>Scans</u>	<u>Misses</u>
<u>Turns</u>		
Bottom	55	0 (0%)
Switched	62	0 (0%)
Top	75	4 (6%)
 <u>Straight, Level</u>		
Bottom	51	0 (0%)
Switched	105	0 (0%)
 <u>Range < 25 nmi</u>		
<u>Turns</u>		
Bottom	46	1 (2%)
Switched	146	7 (5%)
 <u>Straight*</u>		
Bottom	123	3 (2%)
Switched	529	2 (0%)

*The T-29 replied to mode C interrogations with brackets only.
At ranges > 25 nmi the altitude was kept constant at 12,000 ft.

T-39

Percentages of lost targets as a function of range, antenna configuration and type of maneuver for the T-39 are listed in Table VII. These data were collected during the preliminary tests of 25 July 1972. The sample sizes for 360° turns are smaller than for most of the aircraft tested during the formal tests, with corresponding decreases in the confidence of test results. More importantly, turns were not repeated, possibly making the effect of such extraneous variables as range and interrogator patterns more significant in these data than in data collected during the formal tests.

The percentages of lost targets decreased in general with a decrease in range. Straight and level flight usually produced lower miss rates than did turns for all ranges and antenna configurations with the exception of the bottom-only antenna at ranges > 25 nmi. This anomaly was probably due to the extraneous variables mentioned above.

It would appear that the performance of the bottom antenna during ascents or descents at ranges > 25 nmi was considerably worse than that of the switched antennas. However, the sample sizes were unusually small for this maneuver, and represent only one climbout in each antenna configuration. Moreover, the climbout with the bottom antenna was on a radial from the interrogator, thereby shielding the bottom antenna, whereas the climbout path with switched antennas was sufficiently off radial that simultaneous illumination of both top and bottom antennas may have been possible.

The percentage of lost targets for the bottom antenna during straight and level flight at ranges > 25 nmi was surprisingly higher than that for the switched antennas. A closer examination revealed that eight of the 15 misses

Table VII. T-39.

<u>Range > 25 nmi</u>		
	<u>Scans</u>	<u>Misses</u>
<u>Turns</u>		
Bottom	80	3 (4%)
Switched	77	8 (10%)
<u>Straight, Ascending or Descending</u>		
Bottom	35	6 (17%)
Switched	18	0 (0%)
<u>Straight, Level</u>		
Bottom	185	15 (8%)
Switched	273	2 (1%)
<u>Range < 25 nmi</u>		
<u>Turns</u>		
Bottom	135	5 (4%)
Switched	62	1 (2%)
Top	32	1 (3%)
<u>Straight, Ascending or Descending</u>		
Bottom	14	0 (0%)
Switched	87	0 (0%)
Top	112	0 (0%)
<u>Straight, Level</u>		
Bottom	186	1 (1%)
Switched	233	2 (1%)
Top	80	2 (3%)

were consecutive, and during a time when the bottom antenna should have been well illuminated (the flight path was almost perpendicular to the radial to the interrogator). This event seems so unlikely as to imply that the misses were attributable to factors other than shielding of the bottom antenna. However, even discounting the eight questionable misses by the bottom antenna, thereby reducing the percentage of missed targets from eight to approximately 4%, the performance of the bottom antenna during level flight at long range was still inferior to that of the switched antennas. The explanation might have been the rather excellent coverage of both top and bottom antennas and the fact that identical flight paths were not flown in each antenna configuration.

As shown by Figure 11, neither the bottom nor switched antenna configurations was prone to consecutive misses. There was no statistical difference (to 0.9 level of confidence) between the performance of the bottom or switched antennas during turns at ranges > 25 nmi. The bottom antenna appeared to be superior in straight and level flight at long ranges.

The sample standard deviation in azimuth for the switched antennas was almost twice that for the bottom-only antenna (0.22° vs 0.13°).

T-39: TURNS AT RANGES > 25 NMI

18-4-16059

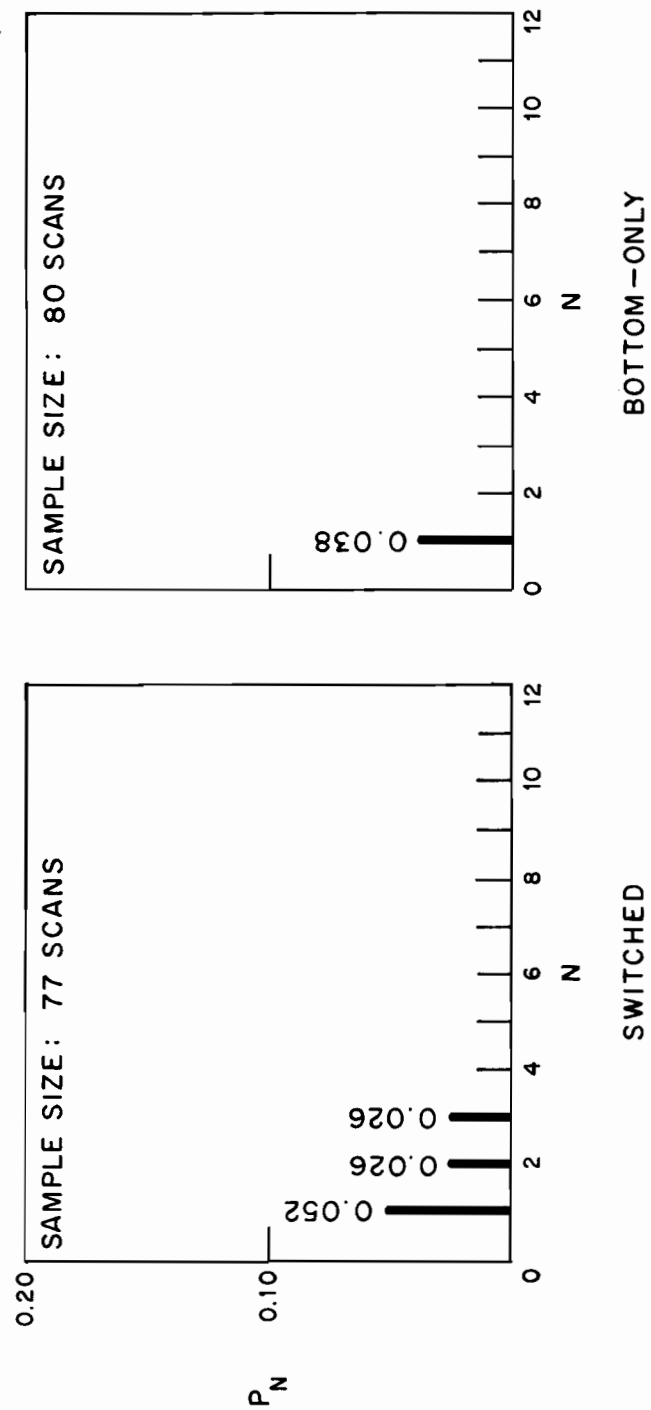

Fig. 11. Estimated probability of n or more consecutive misses, T-39.

F-106

The F-106 does not have a cockpit selector switch; hence, two aircraft were used in the tests, one in the standard configuration with both antennas connected to the lobing switch, the other with the bottom antenna connected directly to the transponder. A complete bench check-out of both transponders before and after the flights precludes the possibility of arriving at false conclusions because of inherent differences in their performances. Turns at ranges > 25 nmi were successfully flown over essentially the same track in each configuration, eliminating to first order the uncertainty caused by lobing in the interrogator antenna pattern.

During both turns and straight and level flight at ranges > 25 nmi, a larger percentage of targets was missed in the switched antenna mode than in the bottom-only mode as shown in Table VIII. The switched antennas produced a smaller miss rate at shorter ranges. Data were not collected on the performance of the bottom configuration at ranges < 25 nmi.

The higher miss rate of the switched antennas in turns at range > 25 nmi was reflected in its distribution of consecutive misses as shown in Figure 12. To 0.9 level of confidence, the switched antenna's performance was worse than that of the bottom-only antenna. There was no appreciable difference in azimuth jitter. It was concluded that for the F-106, the bottom antenna was the preferred choice for terminal areas.

Table VIII. F-106.

<u>Range > 25 nmi</u>		
	<u>Scans</u>	<u>Misses</u>
<u>Turns</u>		
Bottom	146	10 (7%)
Switched	178	26 (15%)
 <u>Straight, Level</u>		
Bottom	129	0 (0%)
Switched	259	11 (4%)
 <u>Range < 25 nmi</u>		
<u>Turns</u>		
Switched	18	0 (0%)
 <u>Straight, Ascending or Decending</u>		
Switched	115	1 (1%)

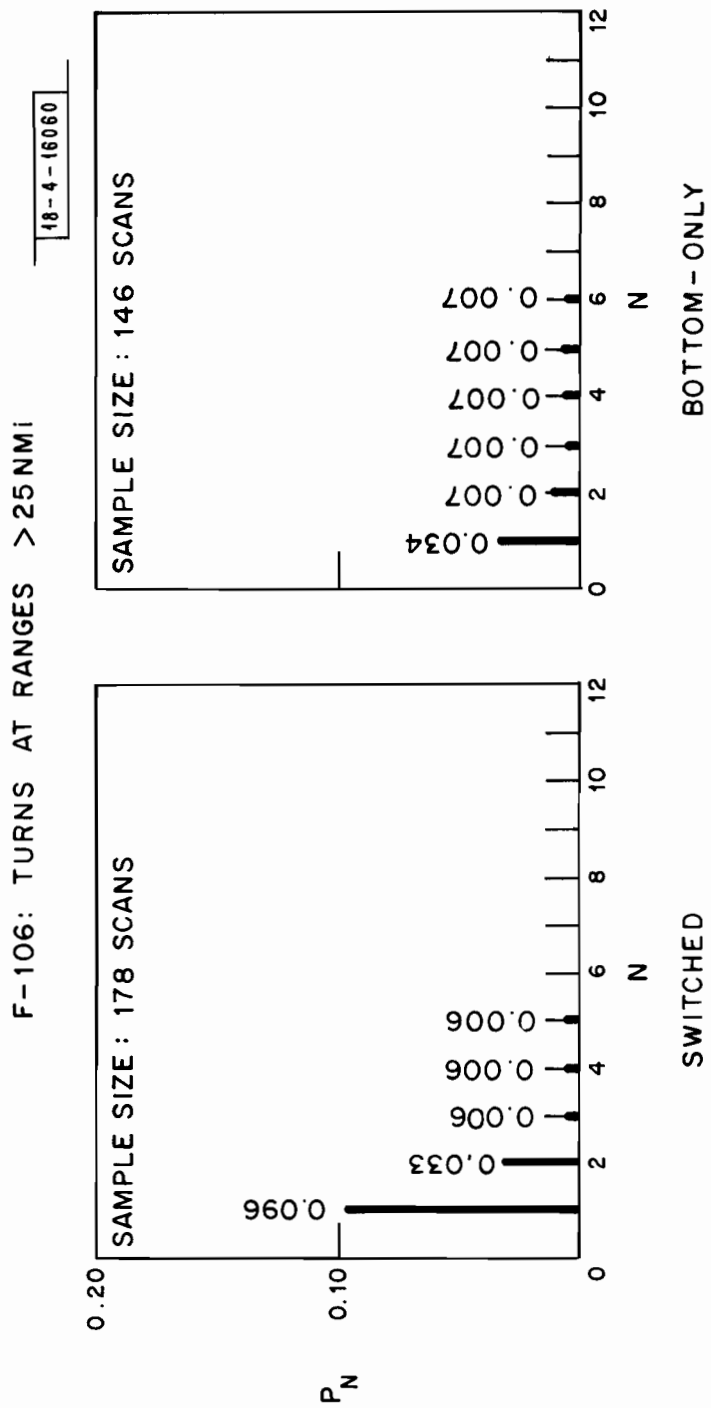

Fig. 12. Estimated probability of n or more consecutive misses, F-106.

A-4

The A-4 used in the test was equipped with the older CS-432A mechanical lobing switch, operating at a frequency of 20 ± 3 Hz. (All other aircraft used in the tests were equipped with the SA-1474/A solid-state switch, which operates at a nominal frequency of 38 Hz.) Since the switching frequency for the A-4 is roughly half that of the other aircraft, we would expect defruited hits and misses to occur in strings of approximately 9 and 11 replies, respectively, instead of the 4 and 7 obtained when the 38 Hz switch is used (with one antenna shielded). As shown by the data in Appendix A, this was indeed the case. Since the beamwidth is only on the order of 18 interrogations wide, if the switching occurred near the center of the beam we would expect to receive a single reply string of approximately 10 consecutive replies, similar to the run length for a bottom antenna which is partially shadowed. Obviously, the azimuth jitter would be increased by such switching.

As shown by Table IX, during turns at ranges > 25 nmi no target was declared for one-sixth of the scans when switched antennas were used. The bottom antenna's performance during such turns was also poor. Since the performance of both configurations markedly improved during straight and level flight, the implication is that the coverage of the bottom antenna decreases rapidly with roll angle. The dependence of the probability of target declaration on range was again demonstrated.

Table IX. A-4.

	<u>Range > 25 nmi</u>	
	<u>Scans</u>	<u>Misses</u>
<u>Turns</u>		
Bottom	294	66 (22%)
Switched	315	55 (17%)
<u>Straight, Level</u>		
Bottom	182	6 (3%)
Switched	253	20 (8%)
<u>Straight, Ascending or Descending</u>		
Bottom	67	1 (1%)

	<u>Range < 25 nmi</u>	
<u>Turns</u>		
Bottom	78	6 (8%)
Switched	96	8 (8%)
<u>Straight, Level</u>		
Switched	100	1 (1%)
<u>Straight, Ascending or Descending</u>		
Bottom	93	3 (3%)
Switched	83	1 (1%)

The distribution of consecutive missed targets for turns at ranges > 25 nmi is shown in Figure 13. There was no significant difference in distributions of consecutive misses on long range turns for the two antenna selections. Since azimuth jitter was less for the bottom than for switched antennas (0.11° vs 0.25°), and the bottom antenna had a significantly lower miss rate in straight and level flight at ranges > 25 nmi, the bottom antenna is preferable for the A-4 in the terminal area.

A4D: TURNS AT RANGES > 25 NMI

18-4-18061

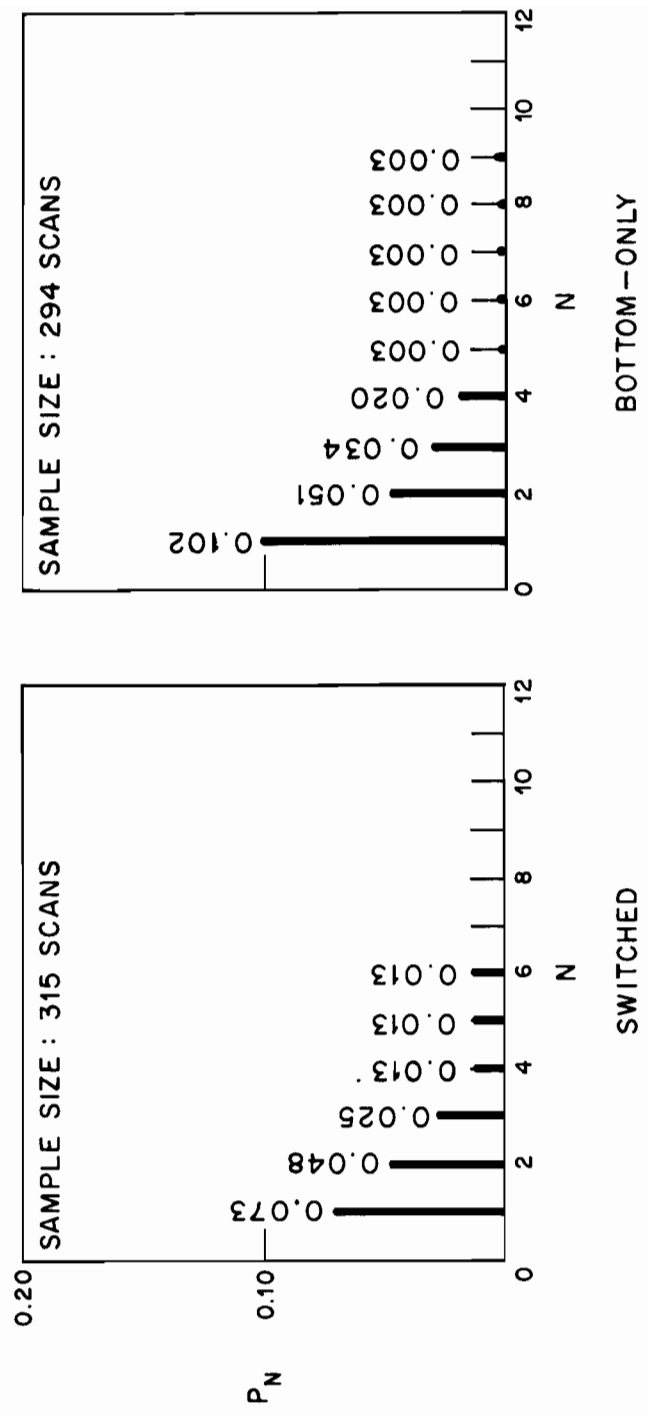

Fig. 13. Estimated probability of n or more consecutive misses, A-4.

F-105

Turns at Patuxent with the bottom antenna were not flown at the same location as those with switched antennas, because of traffic. However, there was no difference between the miss rates at Patuxent and Brooke in either configuration. Therefore it was concluded that vertical lobes in the interrogator pattern, if present, were comparable at both places.

As noted earlier, in IIA, the bottom antenna on the F-105 is partially surrounded by wing tanks and other external appurtenances. It should be expected that this would contribute to the probability that the bottom antenna would be shielded from interrogations. As shown in Table X, during turns at ranges > 25 nmi, use of the bottom antenna resulted in a loss of 22% of the possible target declarations. Even the top antenna was apparently in a better location, since only 9% of the targets were lost in that configuration. The tests also indicated that the probability of a lost target was significantly less for level flight at ranges > 25 nmi than for turns, and that the percentage of lost targets for the switched antenna could be expected to drop as the range was decreased.

Although the percentage of misses was almost identical for the bottom-only and switched antennas in turns at ranges < 25 nmi, the likelihood of obtaining long strings of consecutive misses tended to be greater for the bottom antenna than for switched antennas as shown in Figure 14. Therefore the performance of the switched antennas was judged to be superior to that of the bottom antenna for the F-105, during long range turns, in the terminal area. In straight and level flight at long ranges the performance of the bottom antenna was significantly better than that of the switched antennas.

Table X. F-105.

<u>Range > 25 nmi</u>		
	<u>Scans</u>	<u>Misses</u>
<u>Turns</u>		
Bottom	320	69 (22%)
Switched	330	70 (21%)
Top	126	11 (9%)
<u>Straight, Level</u>		
Bottom	123	3 (2%)
Switched	85	7 (8%)
<u>Range < 25 nmi</u>		
<u>Turns</u>		
Switched	74	9 (12%)
<u>Straight, Ascending or Descending</u>		
Switched	160	7 (4%)

F-105: TURNS AT RANGES > 25 NMI

18-4-16062

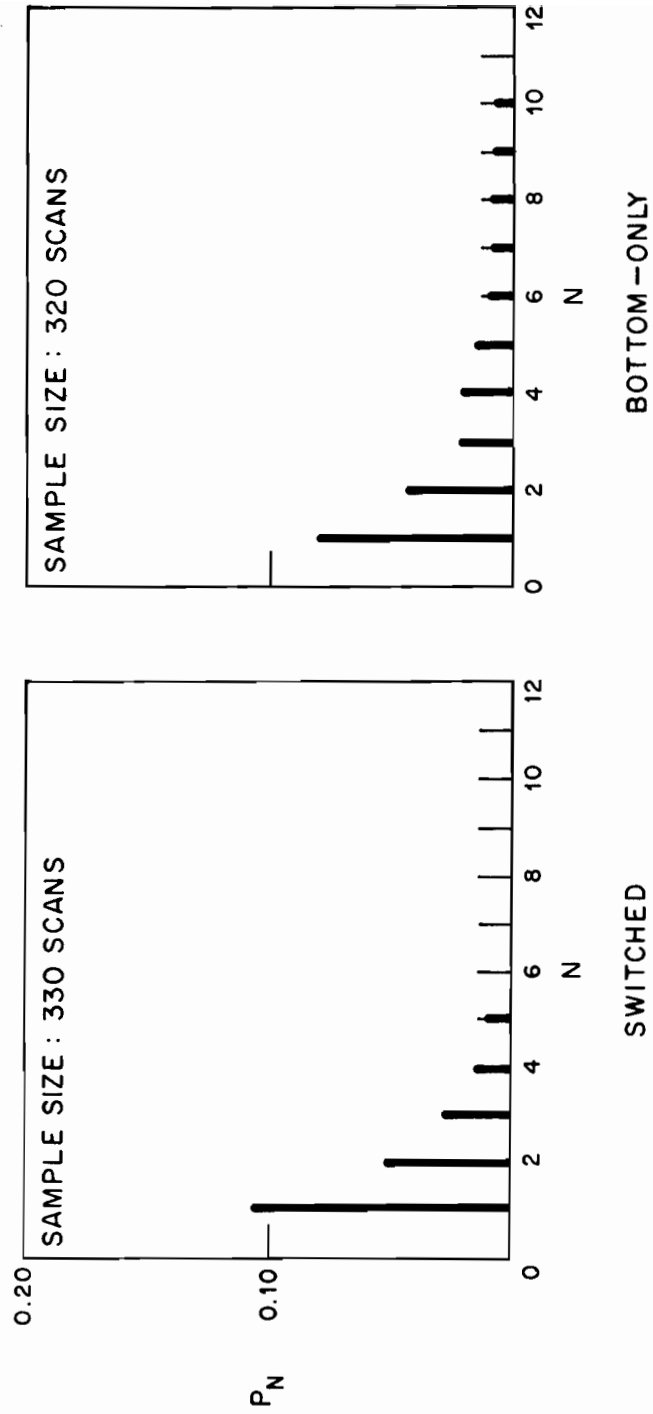

Fig. 14. Estimated probability of n or more consecutive misses, F-105.

The sample standard deviation in azimuth for the switched antennas was more than four times that for the bottom-only antenna (0.36° vs 0.08°).

C-141

In an effort to expedite data gathering, both the ARTS III and En Route tests were made during a single flight of a C-141. The time spent during the En Route test was unexpectedly long and reduced the time available for tests against ARTS III. Poor communication with the aircraft also raises some doubts about which antenna had been selected; therefore, the antenna configurations listed for the C-141 are derived from consideration of the flight plan, reply patterns, and information relayed by a controller at the ARTS III site. In general, correlation between the three sources of information regarding antenna configuration was good, lending credence to the antenna configurations listed in the data. To further increase this confidence data from those cases in which the three sources of information regarding antenna configuration did not correlate were not utilized in the analysis of antenna performance.

Another factor contributing to the difficulties during the C-141 test was a failure of the ARTS III system prior to the arrival of the test aircraft (the system was up, however, during the duration of the test flight). In addition, on numerous occasions a given reply was recorded in two adjacent range bins, suggesting that the C-141's reply pulses were out of tolerance. However, wide-band recording at Elwood disproves this possibility; hence, the problem may have been with the processor.

The performance of the C-141 was quite good in both antenna configurations, as shown in Table XI. To 0.9 level of confidence, there was no significant difference between the distributions of consecutive misses during turns

Table XI. C-141.

Range > 25 nmi

<u>Turns</u>	<u>Scans</u>	<u>Misses</u>
Bottom	99	6 (6%)
Switched	72	4 (6%)
Top	71	7 (10%)
 <u>Straight, Level</u>		
Bottom	119	3 (3%)
Switched	49	3 (6%)

at ranges > 25 nmi, as shown in Figure 15. The miss rate of the switched antennas tended to be higher in straight and level flight than that of the bottom antenna. Azimuth jitter with switched antennas was almost twice that of the bottom antenna, (0.18° vs 0.10°).

C-141: TURNS AT RANGES >25 NMI

18-4-16063

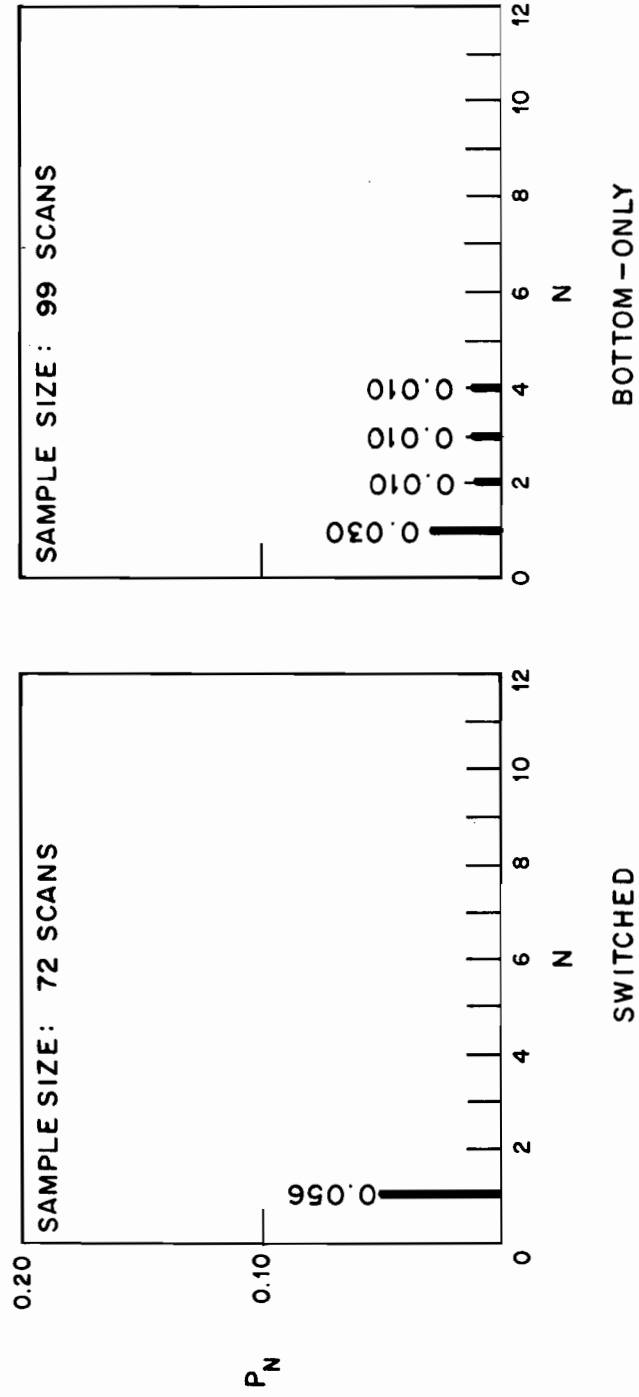

Fig. 15. Estimated probability of n or more consecutive misses, C-141.

C-1

The C-1 was equipped with the Hartlobe antenna diversity system, in addition to the standard transponder and lobing switch. Data were collected for all four configurations, to include evaluation of the experimental Hartlobe system. Since the antennas used for the Hartlobe system were not co-located with those used by the other three configurations, some changes in the probability of antenna shielding were to be expected, affecting the relative performance of the Hartlobe system and the standard bottom, top, and switched antenna configurations.

As shown by Table XII and Figures 16a, b, and c, all four antenna configurations performed very well. During turns at long ranges, the Hartlobe system was significantly better than the bottom antenna, while there was no significant difference between the performance of the bottom and switched antennas. There was no significant difference in consecutive misses between the Hartlobe system and the switched antennas. Since the azimuth jitter was less for the Hartlobe system than for the switched antennas, the conclusion was that the Hartlobe system was preferred, followed by the switched antennas, and last, the bottom antenna, as far as the terminal area is concerned.

Table XII. C-1.

Range > 25 nmi

	<u>Scans</u>	<u>Misses</u>
<u>Turns</u>		
Bottom	91	6 (7%)
Switched	76	1 (1%)
Top	77	2 (3%)
Hartlobe	226	2 (1%)
<u>Straight, Level</u>		
Bottom	188	2 (1%)

Range < 25 nmi

<u>Turns</u>		
Bottom	143	3 (2%)
Switched	150	6 (4%)
Top	106	9 (8%)
Hartlobe	114	3 (3%)
<u>Straight, Level</u>		
Bottom	45	0 (0%)
Switched	161	1 (1%)
<u>Straight, Descending</u>		
Bottom	50	4 (8%)
Switched	65	5 (8%)

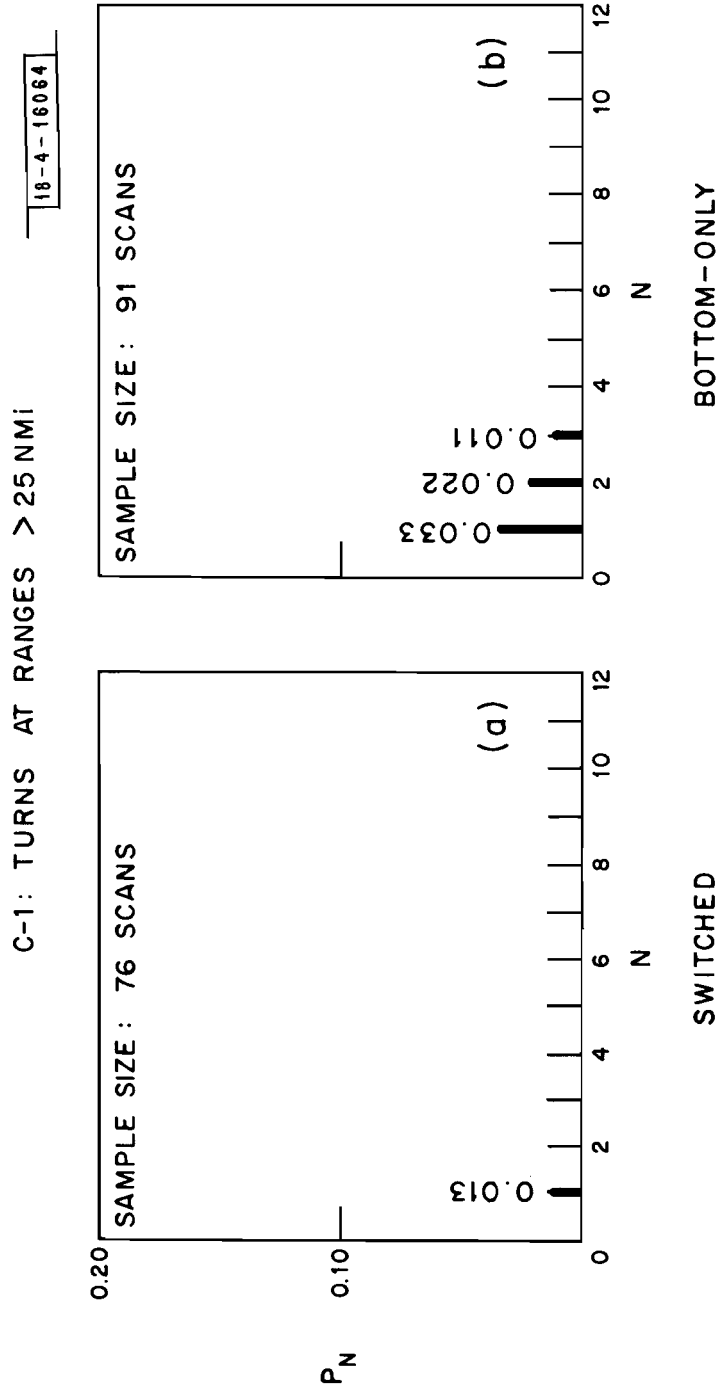

Fig. 16. Estimated probability of n or more consecutive misses, C-1.

18-4-16065

C-1: TURNS AT RANGES >25NMI

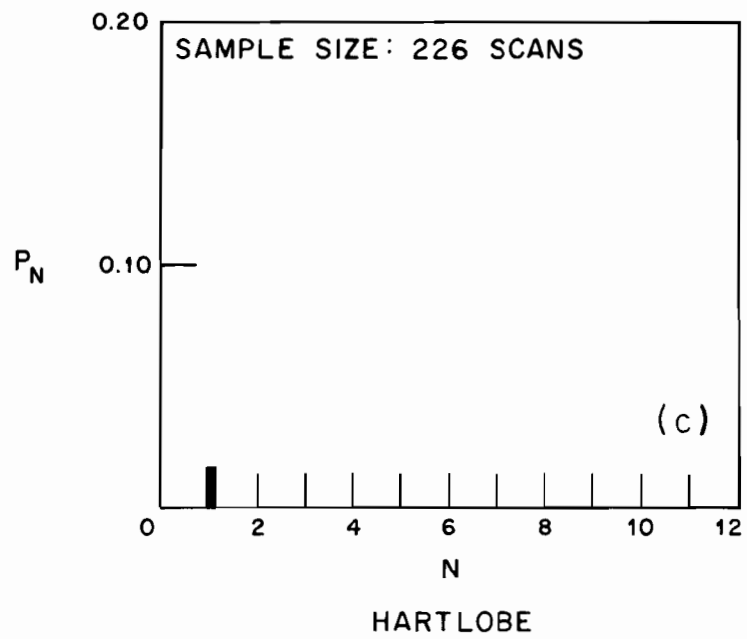

Fig. 16. Continued.

C. En Route Data

Results obtained at NAFEC, using the Elwood site, are summarized in this section, for the various aircraft, in the following order:

<u>AIRCRAFT</u>	<u>CODE</u>	<u>CALL SIGN</u>
T-29	2073	PACER 12
T-39	2027	YELL 36
F-106	2001	EL 09
F-106	2002	EL 04
A-4	2072	ARTS 05
A-4	2071	ARTS 05
F-105	2101	HEY 51
C-141	2105	GLEEK 96

Because of the vast differences between ARTS III extractor output and the output of the PCD augmented by various analog recordings, it has been deemed worthwhile to mention, for each test, periods during which data of each form were being collected.

The nominal form of the data is simply a target declaration made by the PCD and transmitted via modems and telephone lines to an FR-1800 recorder at NAFEC. A routine reformatting and computer processing yields a printout listing the target of interest scan by scan. However, the vicissitudes of faulty transmission and computer processing can, and did, result in losing some targets that had been actually declared. Therefore, the RAPPI printer output was examined and many of these "lost" targets were found thereon. For the others, during periods when the FR-950 was running, it is generally possible to say categorically that there were or were

not enough replies to have constituted a target. For most of the remaining times, one has the radarscope photographs and the decoder output, and by examination of one or both one can again say, in a great majority of the examples, whether or not a target **should** have been declared. However, there are some scans in which the scope pictures are equivocal and the decoder not operating. For these it was judged best to include them as lost targets with a qualification to the effect that they contribute to an upper limit, and to omit them from a total of certified lost targets. It should be remembered also that decoders differ among themselves to a small degree, so that the GPA-122 would not necessarily pass the same number of replies as the BRG in the PCD.

En Route data for lost targets are summarized in Figure 17a and for azimuth jitter in Figure 17b. The former shows the high percentage of lost targets attributable to turns with the bottom antenna for the F-106, A-4, and F-105. Employing the switch reduced this percentage dramatically for the F-106 and the F-105 but less so for the A-4, for reasons that have been discussed.

An objective, quantitative comparison of azimuth jitter in the En Route data has been difficult to achieve, primarily because the scanning rate does not permit obtaining enough points in each orbit. Furthermore, rather than attempt least squares fits for the entire flight it was necessary to sample the data, in order to reduce the magnitude of the effort to manageable proportions, and this detracts from the confidence one can place in their objectivity. With those caveats, Figure 17b is presented and it shows that jitter in turns is worse with the switch for all aircraft except the T-39. The standard deviations are

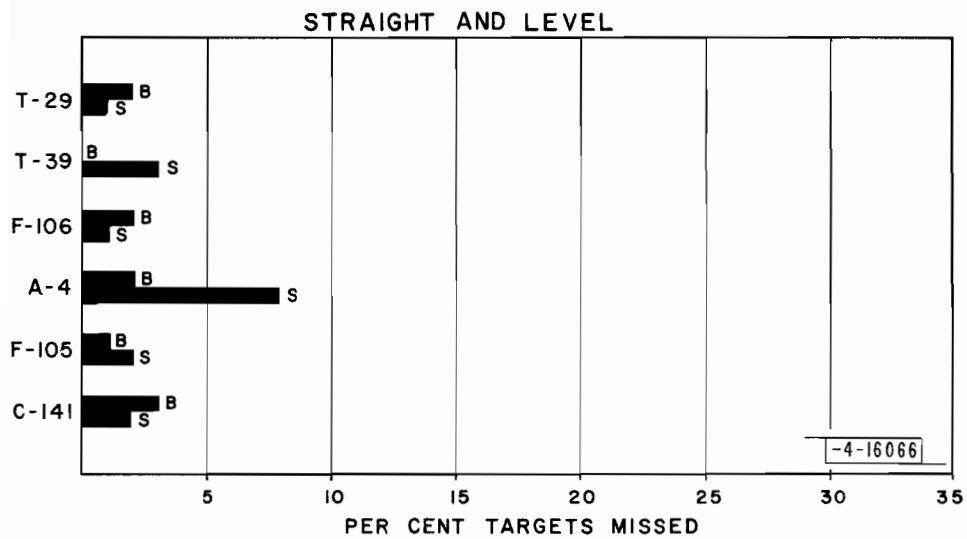
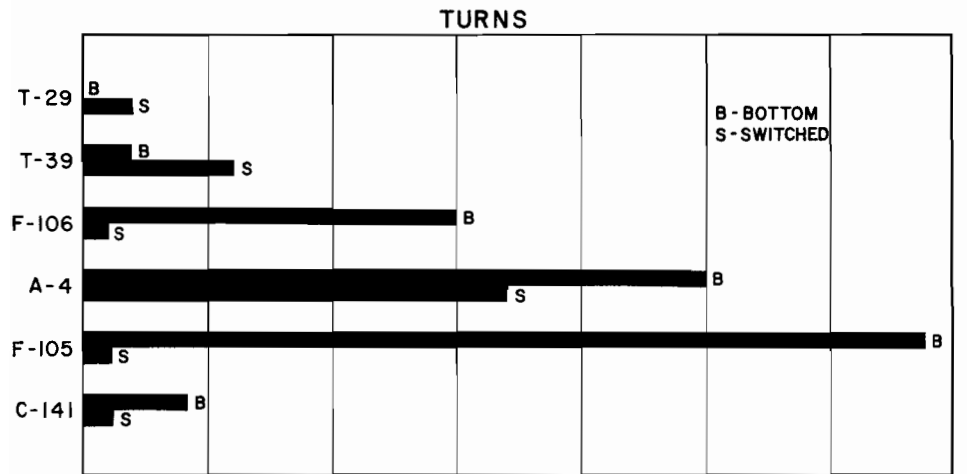

Fig. 17(a). En route miss rates.

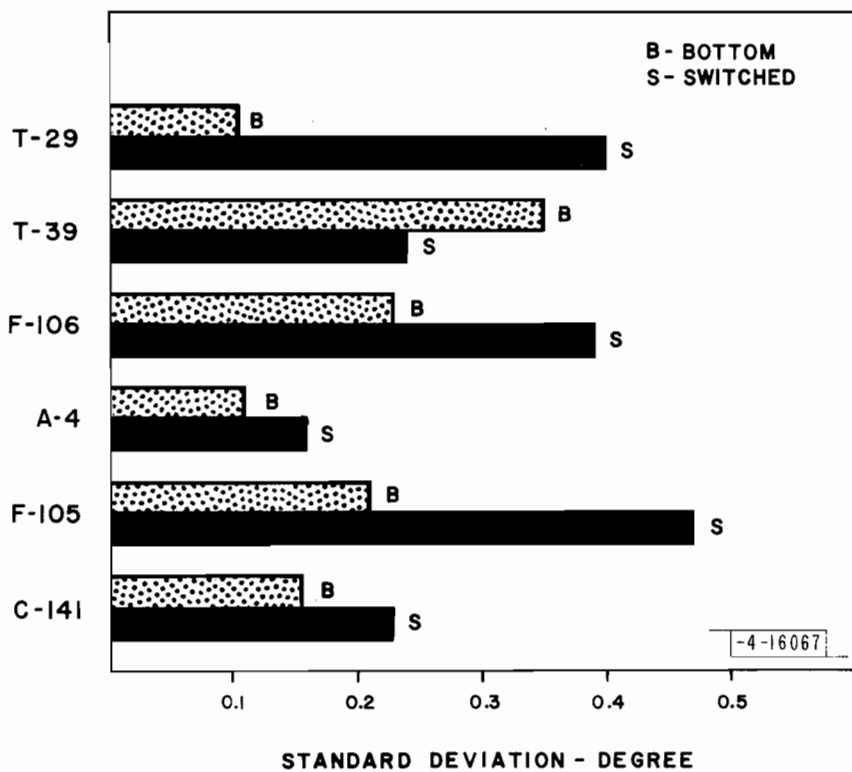

Fig. 17(b). En route azimuth jitter in turns.

all less than 0.5 degree. Visual inspection of track plots indicates that azimuth jitter is seldom encountered in straight and level flight or at ranges of 50 nmi or less.

1. T-29

Because of its poor altitude performance, first orbits for this aircraft were performed over Cape Charles at 16,000 ft and at a range of 145 nmi. The aircraft departed from Andrews AFB at 1000 hours on 16 November, and flew approximately due south to the Farnham Intersection and then via V286 to Cape Charles, beginning the first turn at 10:30. After completing the last orbit, at 10:56, the aircraft was headed for Salisbury, but at 11:00 the pilot requested a change in altitude to 11,000 because of reduced power in one engine. At 11:03, the pilot decided to return to Andrews and at 11:07 data collecting was terminated when the aircraft is presumed to have gone below the horizon. Thus, no data were collected for maneuvers closer to the site or for descents and climbouts.

The Data

First detection occurred as the aircraft was climbing out over the Chesapeake intersection, at 10:05 hours, and the RAPPI operator began manual tracking at 10:09. Scope photography covered the period from 10:17 to 11:03; wideband beacon data were gathered from 10:29 to 10:50.

Discounting the first 24 and the last 26 scans, when only DRANDA is available, there is a total of 339 scans. Correlation with scope photos and/or PICT printout confirms an upper limit of seven lost targets, distributed as follows:

Straight and Level

<u>Antenna</u>	<u>Scans</u>	<u>Misses</u>	<u>Comments</u>
Both	136	(1)	Unconfirmed
Bottom	63	1	
<u>Orbits</u>			
Bottom	42	0	
Both	46	(1)	Probably garbled
Top	53	3 - (4)	1 Possibly garbled

(Numbers in parenthesis include some dubious misses)

Processing of the video data yields a "PICT" printout that displays all signals received in a given azimuth-range cell mosaic with a value between 3 and 16 (F) for each. These were examined for each scan where a target was not declared to seek evidence for potential garbling as shown in Figures 18 and 19, where the scope photo supports an inference that most of the replies that overlapped were garbled and, conversely, that in the absence of that interference the T-29 was a strong beacon target. Plots of the entire ground track and of the orbits alone are shown in Figures 20 and 21, respectively. Azimuthal jitter is very pronounced but appears to be unrelated to the antenna selected on the aircraft. Hypothetically, one may attribute it to the interrogator antenna pattern at the unusually low elevation angle, viz. approximately 0.25° .

Although of limited amount, the data show that the T-29 provided a good detection probability; viz., an overall P_D of 98%, or better. Because most of the misses were for the top antenna, either the bottom antenna or both antennas switching provides an even higher value for P_D , which is essentially the same for both configurations.

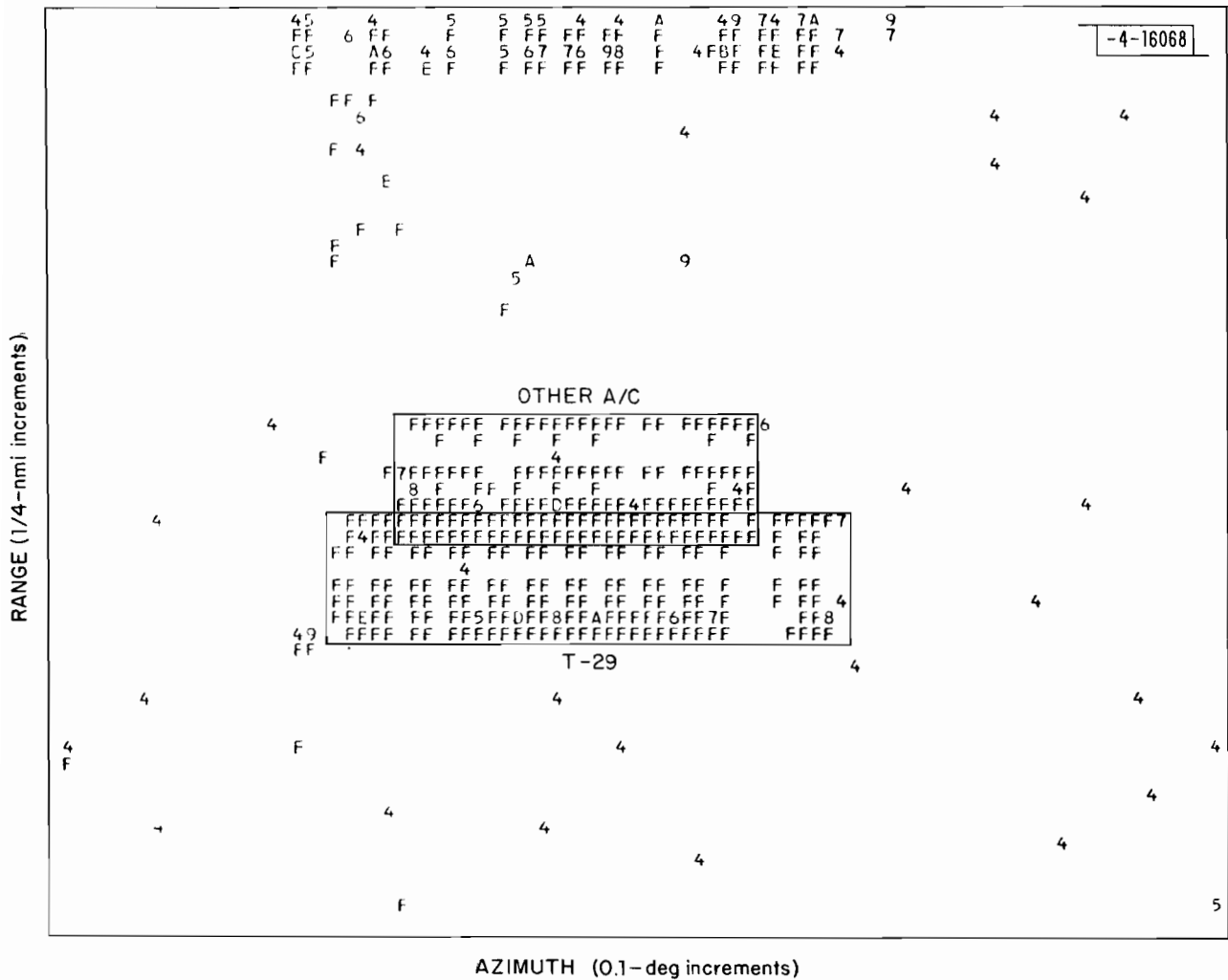

Fig. 18. Potential garbling of replies from the T-29 with those of another aircraft.

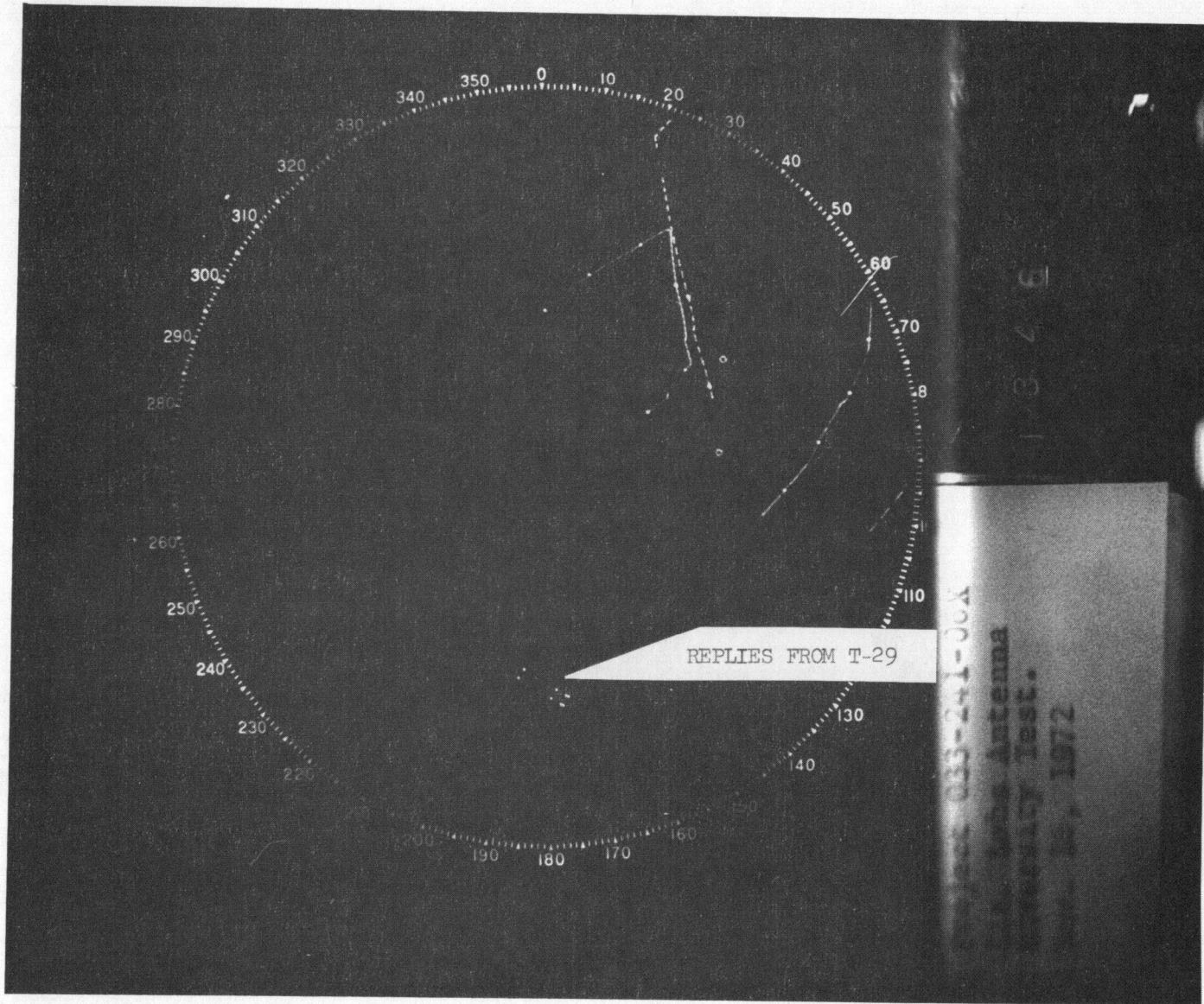
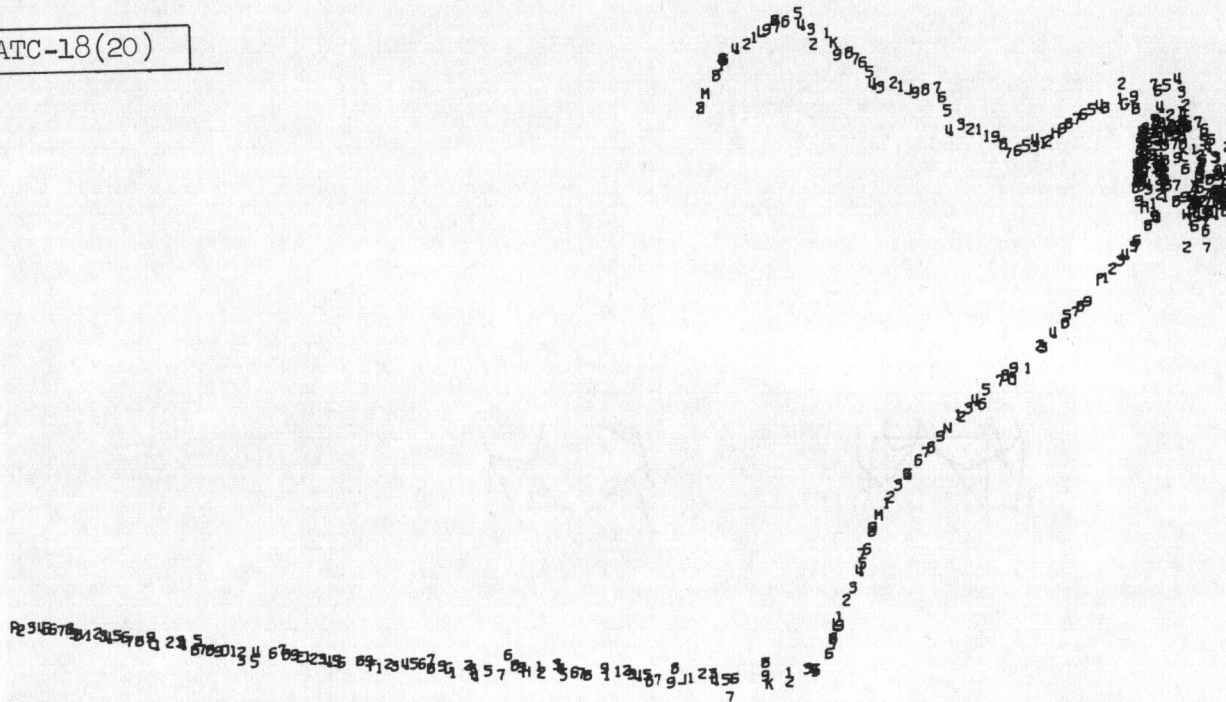

Fig. 19. Corroborative evidence for garbling of replies from the T-29; same scan as Fig. 18.

ATC-18(20)

88



100 NAUTICAL MILES

Fig. 20. En route data T-29.

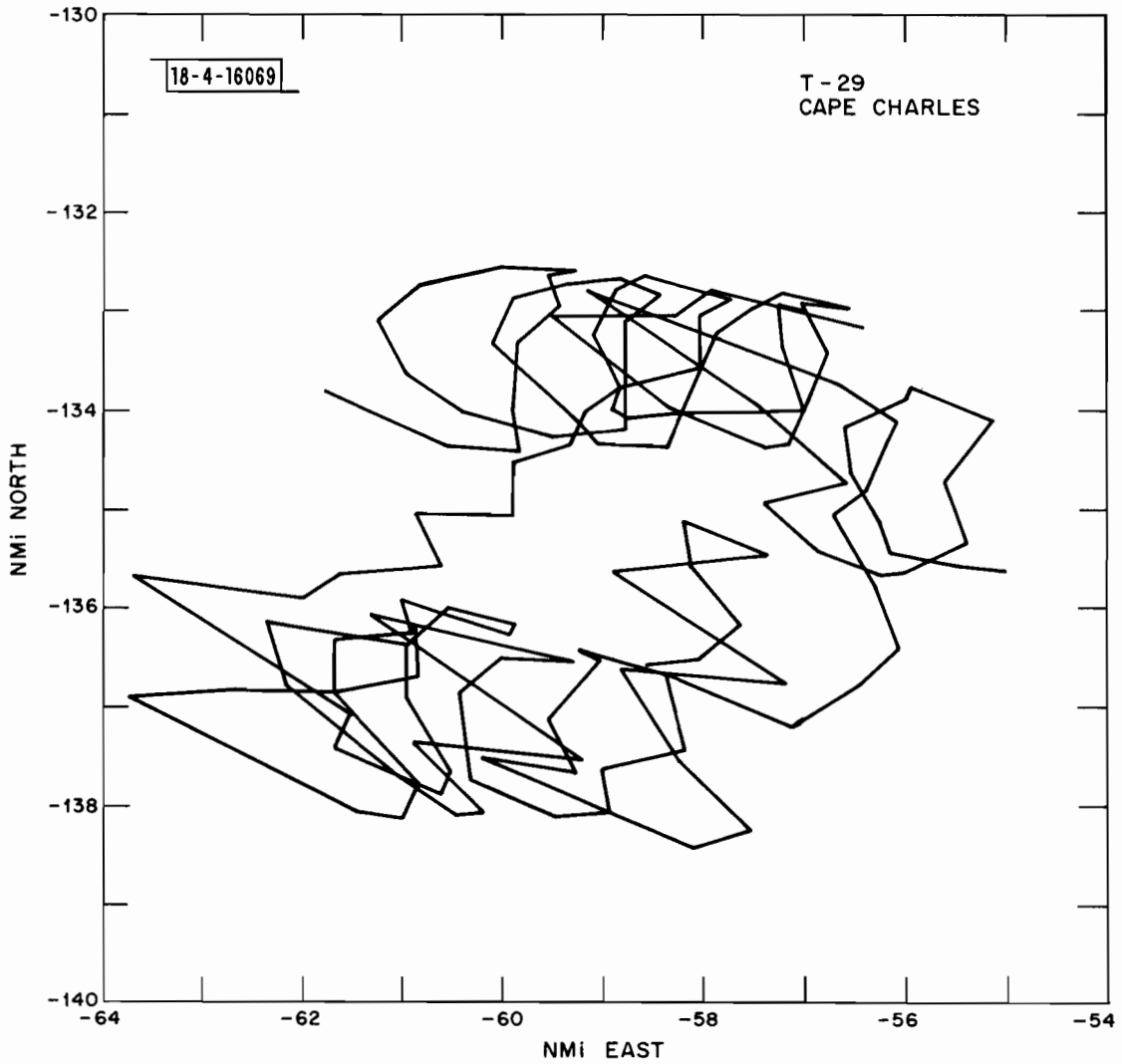

Fig. 21. T-29 aircraft orbiting at Salisbury. Scans 150-312, showing four turns with each antenna configuration and pronounced azimuth jitter.

En Route data were also gathered at Suitland for the T-29 test in the Washington terminal area on 25 October, described in the previous section. These data were recorded and processed at the Washington ARTCC but the PCD at Suitland is essentially the same as that at Elwood, for the purposes of this test. In a continuous period totalling 290 scans, during which the aircraft was executing the maneuvers over PXT and then flying to GRUBBS intersection, the only lost targets were those occurring when the aircraft was virtually overhead, i. e., at a range of 4 nmi or less. Of course, this 100% P_D is associated with relatively short ranges - generally between 10 and 40 nmi.

2. T-39

Actual takeoff was at 0800 hours on 16 November and the aircraft was first detected in the Elwood CD output at 0803 heading SSE and climbing through FL 140, heading for Norfolk VORTAC (ORF) at FL270. As shown by the plot of target declarations in Figure 22, there were few possible misses on this leg. After completing 12 turns at ORF, the aircraft was headed NNE to Salisbury VORTAC (SBY) at FL270, and control turned over to the New York ARTCC. The non-discrete code continued to be employed until the pilot was in the second turn at SBY when photographs and RAPPI coverage could be obtained.

After completing 11 turns at SBY, the aircraft was headed for Sea Isle VORTAC(SIE), using both antennas, and was let down to FL180. Approaching SIE, the aircraft code was changed successively to 1107, 1100, 0400, and then, when turned over to NAFEC radar, back to 2027. A high-altitude

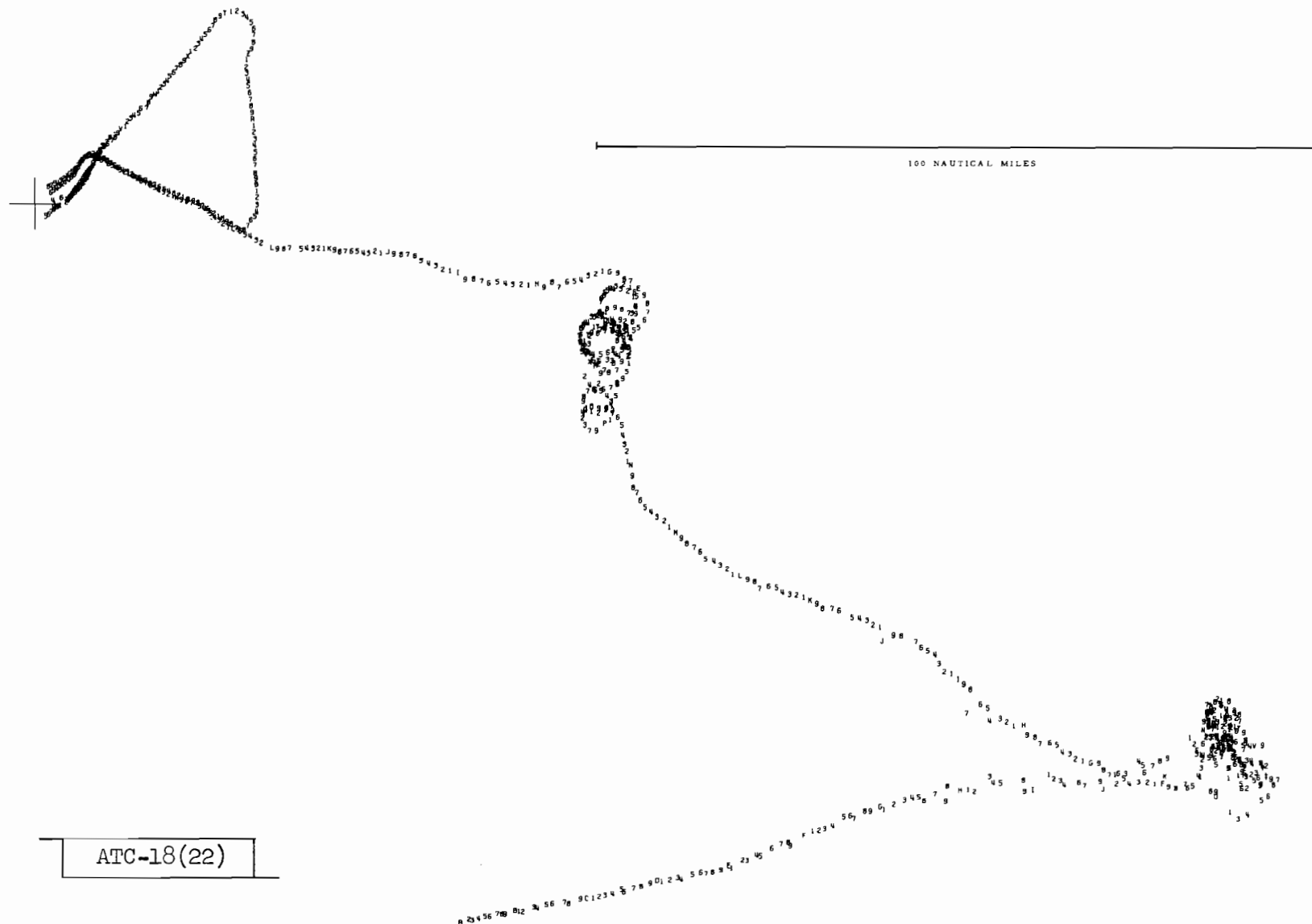

Fig. 22. En route data T-39.

penetration off SIE to Runway 13 was executed, the pilot making a 180° turn over the Elwood site. After a low pass, he continued on the same heading, climbing to FL180 before turning back at a distance of 37 miles, for a second penetration with the bottom antenna selected. A second approach, low pass, and climbout were executed. Data gathering terminated when the aircraft attained a distance of 15 miles, however, when the pilot headed back to ADW under VFR.

For ease of reference, the codes known to have been employed are tabulated in Table XIII, together with the coverage obtained in the various categories of data. A sequential scan number derived from DRANDA printout is given in the first column and may be converted into elapsed time by using the scan time of 9.6 sec.

The Data

Although target declarations for the periods when the aircraft was on codes 0400, 1100, and 2000, have been sifted from the COMDIG printout, the absence of verification through hit counts detracts from the confidence with which one can assign values of detection probability for those periods. Consequently, it is necessary to be cautious in drawing conclusions. It should be further realized that the number of misses reported generally represents an upper limit.

For the straight and level leg from ADW to ORF, with both antennas active, there is an upper limit of four targets possibly lost out of 100 scans. In the 12 turns at ORF, values for probability of detection were 100, 88, and 44%, for bottom, both, and top antennas, respectively, but again, with no confirmatory evidence apart from the plausible sequences of misses oc-

Table XIII. Sources of Data for the T-39 Test Flight.

SCAN	CODE	ANTENNA	RAPPI	PICT	PHOTOS	DECODER
0-100	2000	Both	-	-	-	-
101-161	2000	Bottom	-	-	-	-
162-229	2000	Both	-	-	-	-
230-297	2000	Top	-	-	-	-
298-365	2000	Bottom	-	-	-	-
365-402	2000	Bottom	-	-	X	-
403-406	2027	Bottom	-	-	X	-
407-434	2027	Bottom	X	-	X	X
434-448	2027	Bottom	X	X	X	X
449-501	2027	Both	X	X	X	X
502-568	2027	Top	X	X	X	X
569-578	2027	Both	X	-	X	X
579-603	2027	Both	X	-	-	X
604	1107	Both	X	-	-	-
605-607	1100	Both	X	-	-	-
607-623	0400	Both	X	-	-	-
623-755	2027	Both	X	-	-	X
755-769	2027	Bottom	X	-	-	X
769-882	2027	Bottom	-	-	-	X
882	?	Bottom	-	-	-	-

curing when the top antenna was active and was turned away from the interrogator. Orbits with both antennas and with the top antenna alone were flown progressively farther west, by a few miles, and may have placed the aircraft in a poorer region of coverage by the ATCBI antenna, as an additional factor.

On the straight and level leg from ORF to SBY, in 88 scans there were no misses. In 11 turns at SBY, for which aircraft positions are plotted in Figure 23, the probability of detection was 97, 100, and 78% for bottom, both, and top antennas, respectively, and these values were supported by hit counts and wide band data. For the straight and level leg from SBY to SIE, there was one possible but unconfirmed miss in 62 scans. In the descent, low level pass, ascent, circling around in a wide arc at 30 nmi range and repeated descent and climbout, there were no misses in 250 scans, other than those occurring when the aircraft flew directly over the Elwood site. The foregoing data are summarized below.

	<u>Bottom</u>	<u>Both</u>	<u>Top</u>
<u>Straight and Level</u>			
Total Scans	88	162	-
Targets Lost	0	4 -(5)	-
Per Cent Lost	0	3	-
<u>Constant Bank Angle 360^o Turns</u>			
<u>At Norfolk</u>			
Total Scans	71	74	68
Targets Lost	0	(9)	(38)
Per Cent Lost	0	(12)	(56)
<u>At Salisbury</u>			
Total Scans	61	53	64
Targets Lost	2	0	14
Per Cent Lost	3	0	22

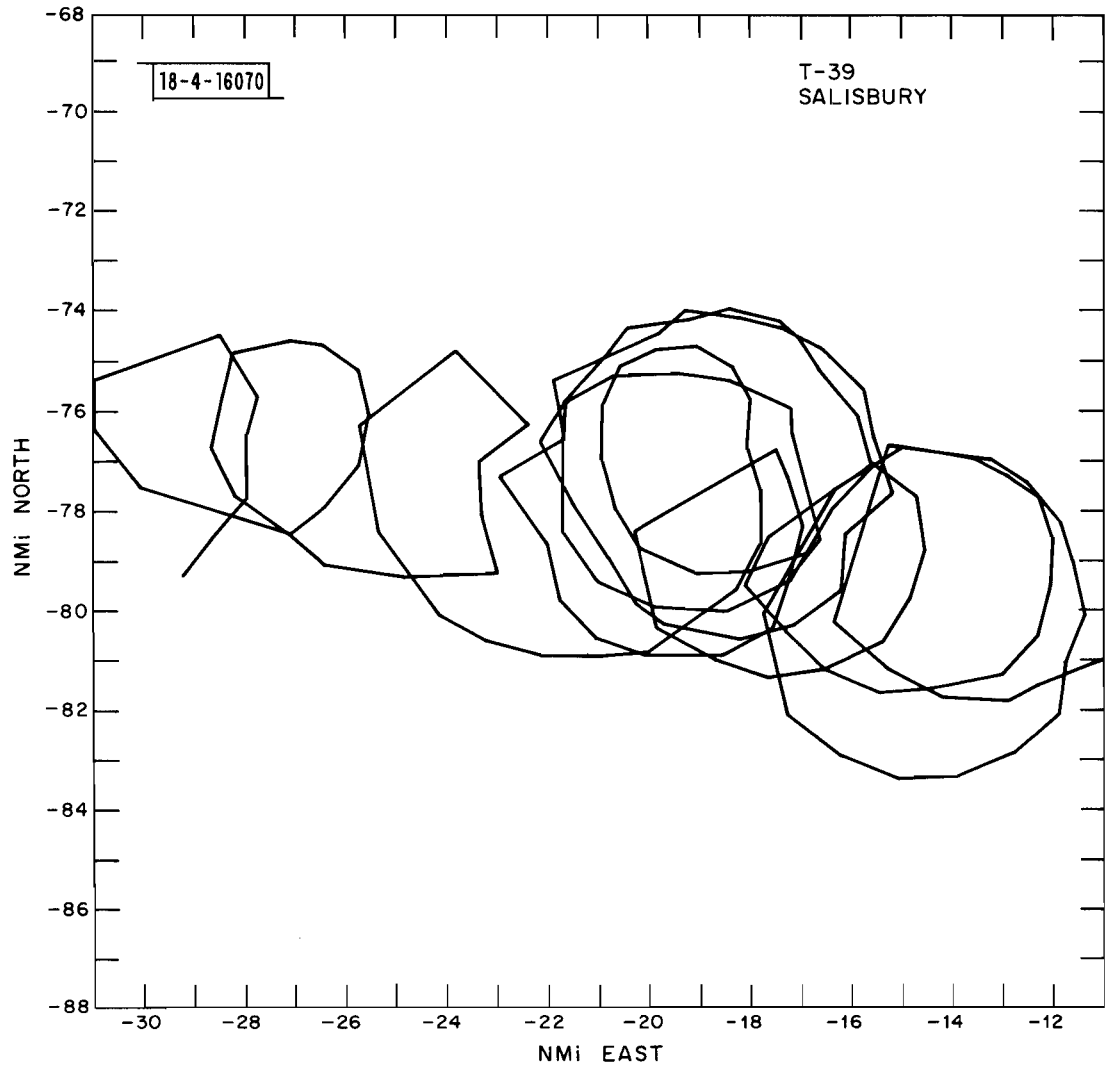

Fig. 23. T-39 aircraft performing 11 360° turns at Salisbury.

With the bottom antenna and the aircraft in turns at SBY, the two isolated misses occurred when the aircraft was presenting a side aspect and the antenna was turned away from the interrogator. The absence of such misses during turns at ORF is additional evidence that they seldom occur even under "worst" conditions. For the top antenna, on the other hand, misses occurred in a generally consistent pattern each time the aircraft was radially outbound and were distributed as three singles, one double, and three triple misses. Isolated target declarations thus broke up three of the four strings of consecutive misses that would have been expected.

In straight and level flight, either both antennas switching or the bottom antenna alone appear capable of providing a high (>96%) detection probability, even at ranges of 180 nmi, and the data do not support a choice of one over the other. If attention is turned to data obtained in turns, with emphasis on those at SBY, it again appears that either of those configurations would be satisfactory. On the other hand, the top antenna is clearly inferior, providing a detection probability of only 78%. Less weight can be given to data obtained at ORF, unfortunately, although they are not inconsistent with those for SBY. It may be noteworthy that the bottom antenna provided 100% detection probability, even at that range.

3. F-106

The two F-106s from Dover AFB flew to Patuxent River and performed the ARTS III portion of the test, then proceeded to Norfolk for the En Route portion. As this flight plan was unique to the F-106s, it is reproduced below:

IFR FLIGHT MISSION (F-106)
(Call Signs EL-09, EL-04)

After verifying transponder operation, squawking assigned discrete code in mode 3/A with altitude reporting (mode C), proceed to Patuxent VORTAC at 16,000. Execute four 360° turns at a 60° bank angle. Proceed to Brooke VORTAC and repeat the four 360° left turns, reporting to the controller at Washington Center when beginning the first turn and when rolling out from the last.

With Brooke as IAF, for north operation, execute a high-altitude penetration, HI-ILS Runway 1L at Andrews, descending to 750 ft and making a missed approach at the MAP. Turn right to Nottingham VORTAC at 3,000 ft, or as controlled, climb out at maximum rate of climb and proceed to Norfolk VORTAC at FL270 or above.

Execute four 360° left turns, with 60° bank angle, at ORF. Proceed to Salisbury VORTAC and repeat the four left turns, again reporting their initiation and completion. With Sea Isle VORTAC at 16,000 as IAF, execute a high-altitude penetration to Atlantic City (NAFEC) Runway 13, descending to 750 ft before climbing out at maximum rate of climb on ACY R-130 to W-107 at 16,000. Turn left at ACY DME 20 to Smithville, Crescent, Leesburg, and Dover.

The first F-106 (EL-09) was flown with the normal lobing switch in operation; the second (EL-04) was modified by connecting the lower antenna directly to the transponder, bypassing the switch. As the insertion loss associated with the switch is less than 0.5 dB, this results in a negligible change in radiated power. Both transponders were given complete bench tests, employing the AN/UPM-137, before and after the flights, with satisfactory results.

The first F-106 (EL-09), with both antennas active, departed Dover AFB at 0903 squawking code 2001 and was first detected by the Elwood site at approximately 0905 when it was at a range of 60.5 nmi climbing through 5100 ft en route to the Patuxent VORTAC at 16,000 ft. The second F-106

(EL-04), with the bottom antenna active, departed Dover AFB at 0948 and code 2002 was detected by Elwood at approximately 1000 hours when the aircraft was near Patuxent, at a range of 94 nmi and an altitude of 16,000 ft.

Although the orbits at PXT and Brooke VORTAC (BRV) were not intended to furnish En Route data, they were observed by the Elwood site in their entirety. Moreover, the aircraft were tracked during their approaches to, and climbouts from, ADW at altitudes down to 10,000 ft which, at a range of 123 nmi and a $4/3$ earth radius, corresponds to 0° elevation angle.

Following the orbits at Norfolk (ORF), track was lost on EL-09 for two periods, when the code was changed, prior to orbiting at Salisbury (SBY), and again, soon after departing SBY for Sea Isle. Finally, at SIE, the pilot was placed in a holding pattern which became so protracted that he was forced to abandon the remainder of the flight plan and return to Dover. The second F-106 (EL-04) provided more data as the discrete code was retained and the aircraft was not prevented from completing the test flight planned.

The Data

As the decoder-recorder was not operating on the day of these tests, and the video recorder was employed only intermittently, scope photos are essentially the only source of corroborative hit counts. However, it is not always possible to determine from these photos, in borderline cases, if a target should or should not have been declared. Of even greater significance, unfortunately, is the fact that one of the three lines carrying PCD output data from Elwood was intermittently very noisy and thereby some of the data were destroyed.

For EL-09, Figure 24 presents a plot of aircraft position as given by the COMDIG printout complemented by the RAPPI printer. Many of the missing targets were probably lost in transmission or computer processing and in code changes. Ignoring the periods when it is reasonably certain that the pilot was asked to squawk a different code, there are only five confirmed misses, at the most, one of them occurring during the four 360° , 60° - bank angle turns at SBY. Wideband data for 50 scans covering that period show a few serrated targets, one of which coincides with a possible miss and provides fewer than the T_L threshold. Eight other scans show overlapping replies from other aircraft but not coincident with a lost target. For the **similar** turns at ORF, PICT is not available but scope photos indicate that there were, at the most, only three legitimate misses, although many serrated targets appeared, a sample of which is shown in the scope photo of Figure 25.

For EL-04, Figure 26 presents a plot of aircraft position in which gaps, again, do not imply necessarily a lost target. In the 360° turns at ORF, however, PICT data corroborate the scope photos in confirming 13 of the 15 misses. The two others were out of range of the PICT computational window but also occurred in the same part of the orbits, viz., when the aircraft was banked over on the far side of the turn. These misses were confined to that portion of the orbits and each orbit produced them. As the pilot made three left orbits and then flew SE for one minute before making one right orbit, the number of scans during which the aircraft was turning is fewer than the 50 overall; hence, the probability of a miss is actually greater than the 30% estimated. Runlength varies in a cyclic fashion, as shown in Figure 27, with a maximum of 44 replies when the aircraft was on the near side of each turn. All of the misses correspond to zero runlength, however.

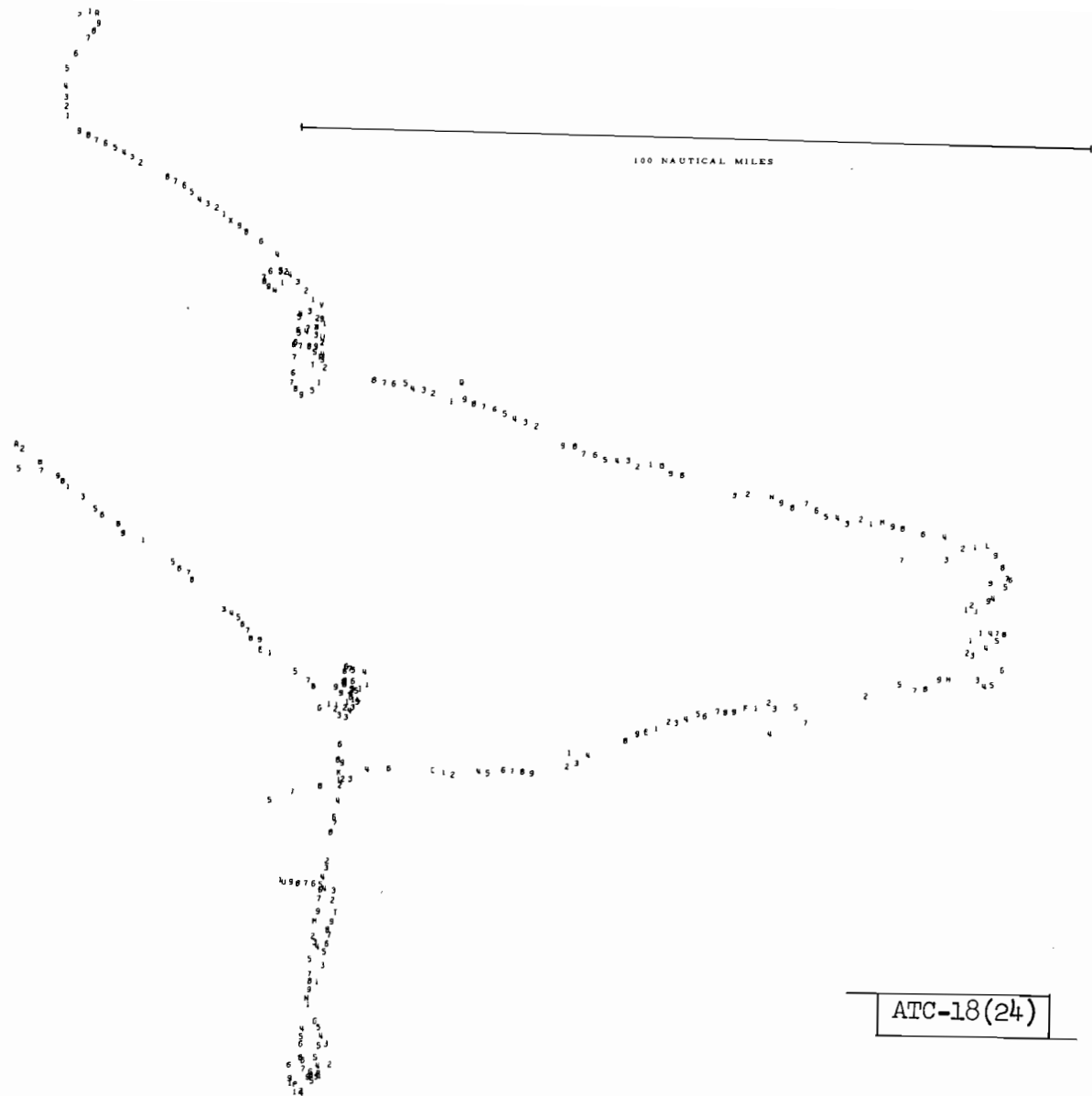
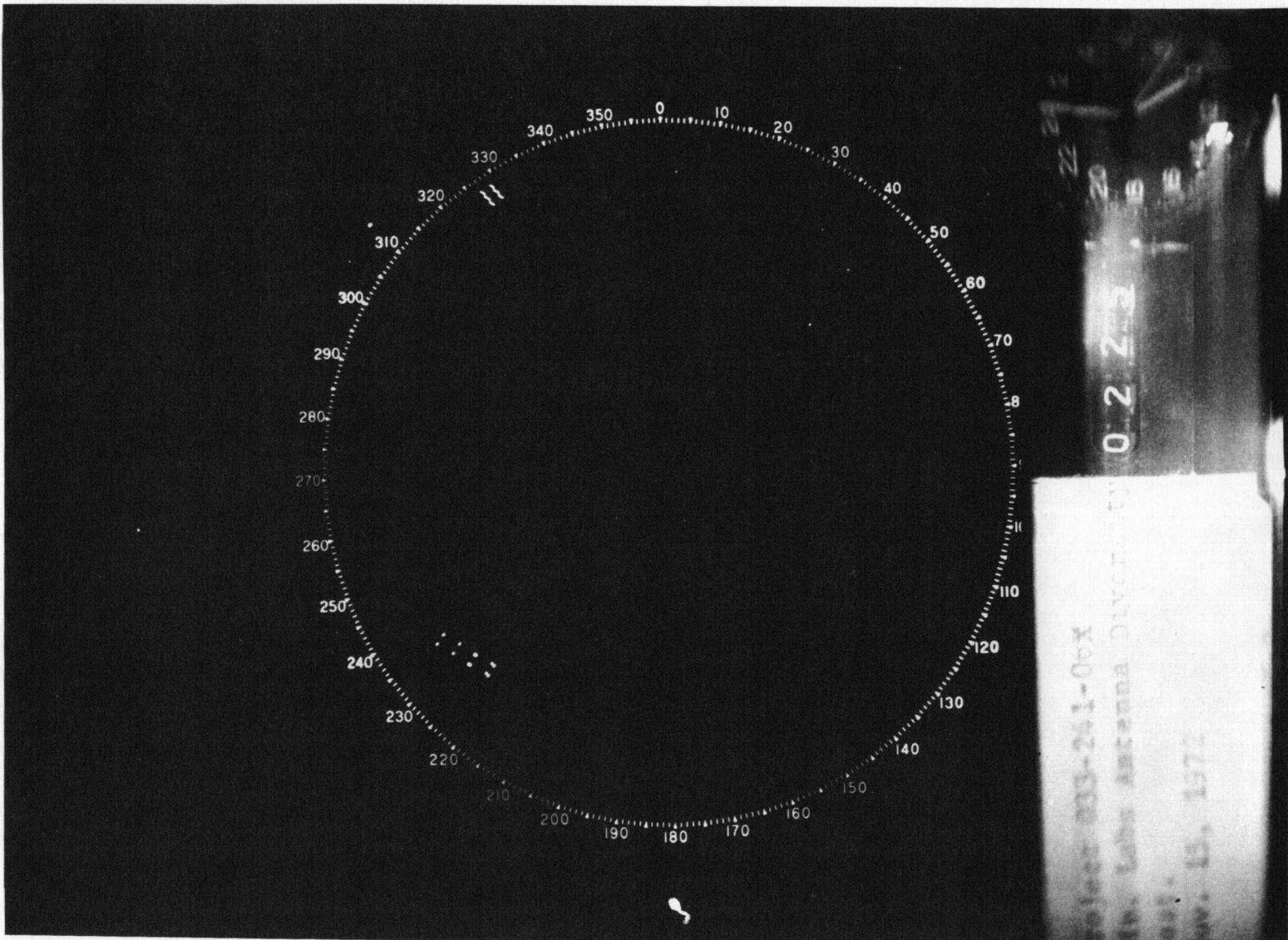
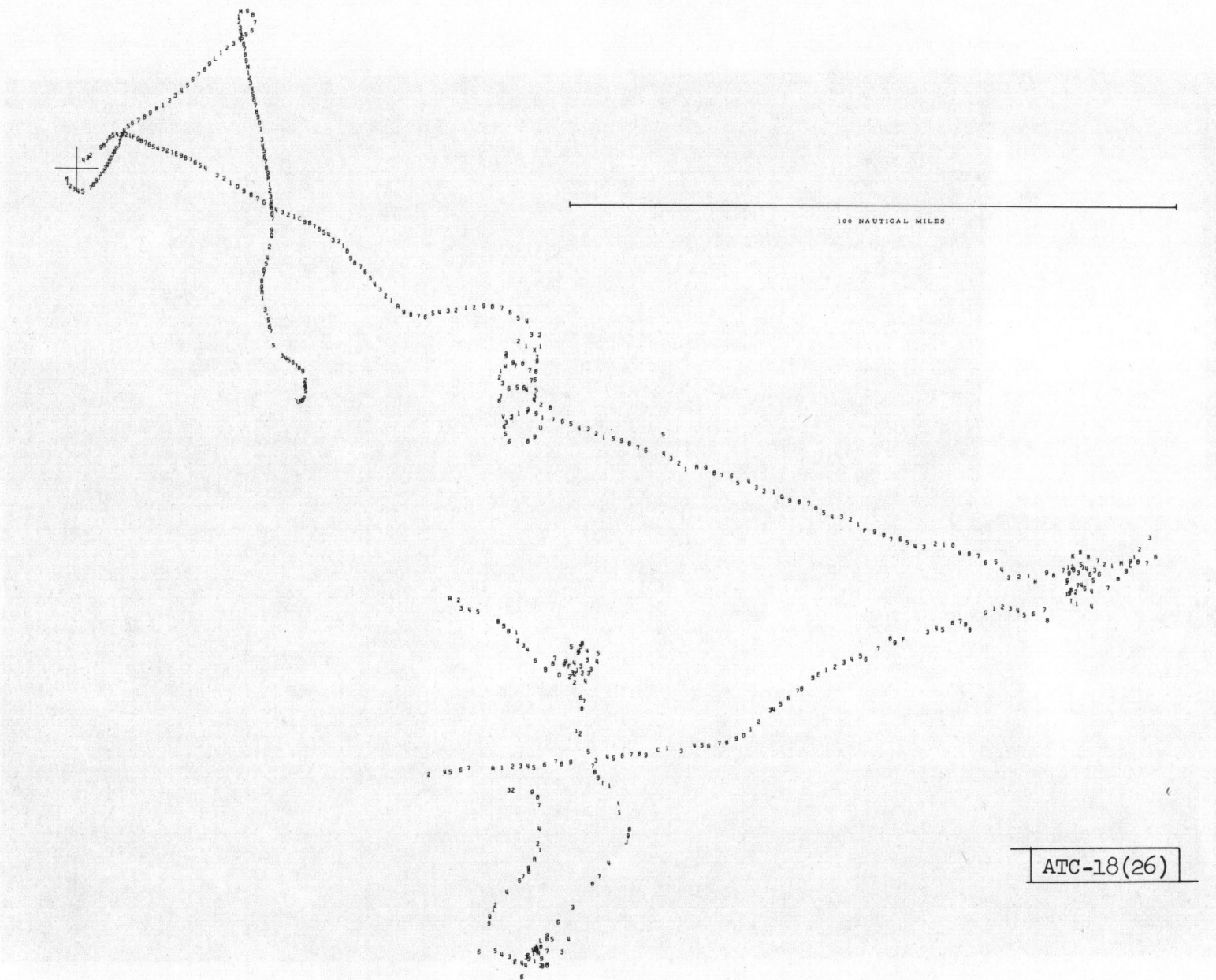

Fig. 24. En route data F-106 (EL 09) both antennas.



101

Fig. 25. Radarscope photograph of F-106 beacon replies during turns at Norfolk, showing serrations caused by the combination of switching and a shadowed antenna.



ATC-18(26)

Fig. 26. En route data F-106 (EL 04) bottom antenna.

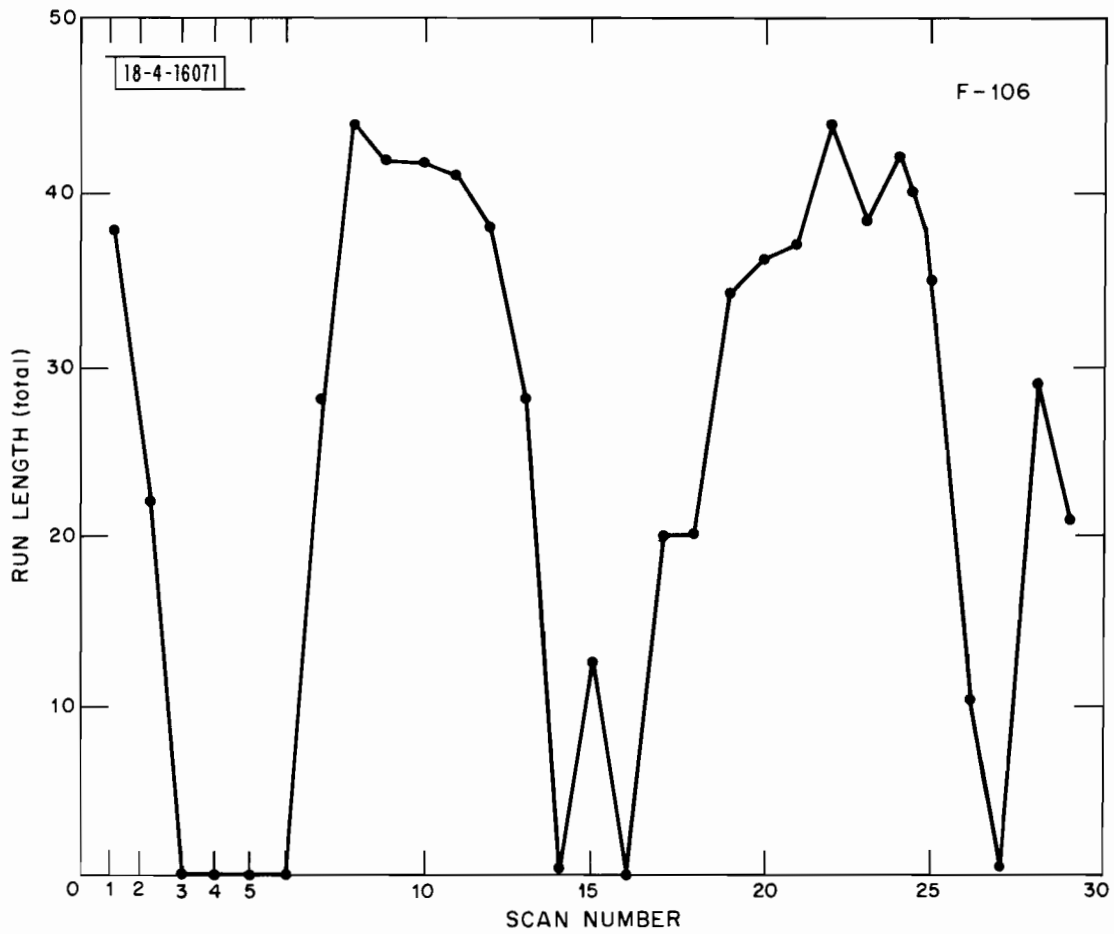

Fig. 27. Total run length vs time for a portion of the turns by an F-106 with bottom antenna.

Although the lost targets are confined to the expected portions of each turn, the number of consecutive misses varied from one string of six to four isolated misses. This may be interpreted to suggest that a constant roll angle was not maintained either during a turn or from one turn to the next. The high rate of lost targets with the bottom antenna is consistent with the serrated appearance of targets for both antennas when the two aircraft were presenting the same aspect angle.

For the turns at SBY by EL-04, PICT data are not available and the aircraft was occasionally off the scope; hence, confirmation of misses is incomplete. In 52 scans there are four possible misses, two of which were confirmed with reasonable certainty and which occurred when the aircraft was headed directly away from the radar. Summarizing the data for 360° turns gives the following for confirmed misses:

	<u>Orbits at ORF</u>	<u>Orbits at SBY</u>
<u>Both Antennas:</u>		
Scans	42	48
Misses	0 (3)*	1
% Lost	0 (7)*	2
<u>Bottom Antenna:</u>		
Scans	50	52
Misses	13 (15)*	2
% Lost	26 (30)*	4

In straight and level flight, the verifiable data are as follows:

	<u>PXT-ORF</u>	<u>ORF-SBY</u>	<u>SBY-SIE</u>
<u>Both Antennas:</u>			
Scans	39	43	
Misses	0	1	
% Lost	0	2	
<u>Bottom Antenna:</u>			
Scans	50	58	50
Misses	2	0	0
% Lost	4	0	0

Because the data are so sparse, it is probably unwise to draw firm conclusions; however, they indicate better performance by the two antennas and switch than by the bottom antenna alone, at least in turns at maximum range. It is plausible that the 6 dB advantage of the closer range to SBY as compared with ORF precluded a high miss rate with the bottom antenna.

*Numbers in parentheses include some dubious misses and therefore may be regarded as upper limits.

4. A-4

Like the F-106, the A-4 is not equipped with an antenna selector in the cockpit; hence, the aircraft made two sorties, first with the bottom antenna connected directly to the transponder; second with both antennas connected via the lobing switch. Prior to the test flights, the transponder was checked out on the bench to U.S. Navy specifications, utilizing the AN/UPM-123 equipment.

Discrete code 2072 was employed for the test with the bottom antenna activated; 2071 was employed for the test with the lobing switch. Altitude readout in response to mode C interrogations was operating.

The Data

Aircraft code 2071 was first detected at 1346 hours as the aircraft climbed through FL161 at a distance of 120 miles en route to Norfolk VORTAC. Coverage with the RAPPI started on scan number 8, scope photography on scan number 1, and video recording at 13:56:48 as the first orbit at ORF was begun. After completing three orbits, the pilot headed for the Salisbury VORTAC (SBY) and video recording was suspended. Reaching SBY at 14:15, the pilot executed the four orbits and an additional 26 scans were recorded on the FR-950.

A quick glance at the plot shown in Figure 28 reveals the erratic behavior of the data obtained in the orbits at ORF and, to a lesser degree, of those pertaining to the flight path from ORF to SBY. The former is caused by numerous lost targets and azimuth jitter; the latter is principally a result of azimuth jitter alone. Some evidence for the inherent capability of the beacon tracking system to do better is afforded by the relatively smooth

track from PXT to CCV, the essential differences being the aspect angle of the aircraft and the range.

The aircraft was next headed for Sea Isle VORTAC (SIE) where the pilot performed a holding pattern and a 360° turn prior to descending from FL160 for an approach to Atlantic City (ACY) Runway 13. Initial descent was at 3000 ft/min. After crossing the airport and executing the procedural turn the pilot made a pass over the runway at 400 ft and climbed out, at an initial rate of 4600 ft/min, continuing on radial 155 to a distance of 23 miles and an altitude of 8800 ft. He then turned to the north and continued climbing before making the wide turn that took the aircraft over the Elwood site at FL163. Data gathering continued until the aircraft entered the restricted area R-4006, at a distance of 80 miles.

Tracking Performance for A-4 (2071) with Both Antennas

	<u>Scans</u>	<u>All Misses</u>	<u>Per Cent</u>
<u>Straight and Level</u>			
PXT - CCV	41	0	0.0
CCV - ORF	27	7	25.0
ORF - SBY	64	5	7.8
SBY - SIE	55	2	3.6
W107 - R4006	<u>128</u>	<u>5*</u>	<u>3.9</u>
TOTAL	315	24	7.6
<u>Orbits</u>			
ORF	45	12	25.0
SBY	34	5	15.0
SIE	33	2	6.0
Descending	50	4	8.0
Climbing out	30	0	0.0

*Omitting one lost when aircraft was overhead at 3-mile range.

Discussion of Switched Antennas

Video recording during the time that the aircraft was turning at ORF reveals two possible causes for the high incidence of lost targets: one was shadowing of one of the antennas; the other was garbling by another transponding aircraft. The 20 cps switching rate results in a dwell time of 25 ms on each antenna, during which nine interrogations would occur. Six of these would be in mode 3/A and, if one antenna be shadowed, there could be six replies and they would be followed by six misses. As the round reliability at the range in question is relatively low, one seldom observes regular groups of six replies.

Figures 29, 30, and 31 show the PICT output from processing the wide-band data and are typical range vs azimuth depictions of beacon replies. Each vertical column is a crude representation of the pulse train in one reply to a single interrogation and it is quantized into 1/4-mile range cells in each of which a value, either blank or from 3 to 16, of the pulse amplitude may be found. Figure 29 represents one of the best targets provided by the A-4 at ORF, and has a run length of 36 with 22 in mode 3/A. Even within this scan, however, five replies (three mode C and two mode 3/A) are missing, suggesting a round reliability at best of ~ 0.86 . Figure 30 represents a typically serrated target; in this example two groups of six hits are separated by 11 misses. The widths of groups varied somewhat but were consistent with a 25 ms dwell time and additional gaps resulting from randomly lost replies. One see by examination of Figure 30 that, for mode 3/A, there are four replies followed by seven misses and then four more replies. Consequently, an 11-hit window cannot show more than four and a leading edge cannot be

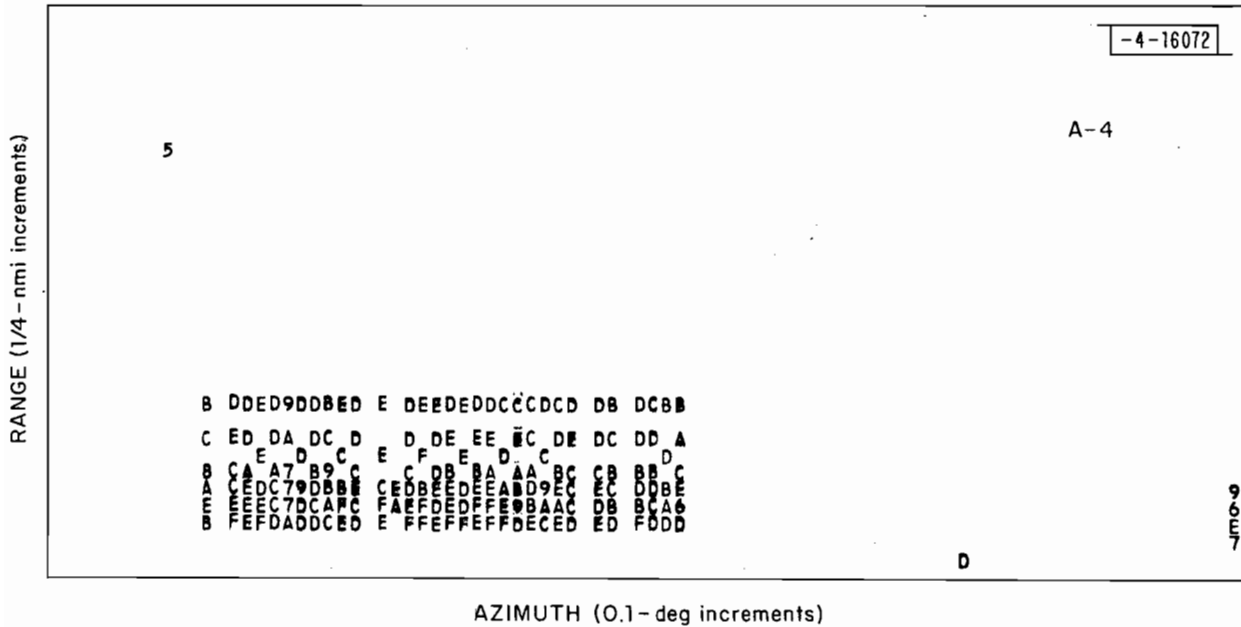

Fig. 29. Range-azimuth picture of replies from the A-4 at a distance of 176 nmi.

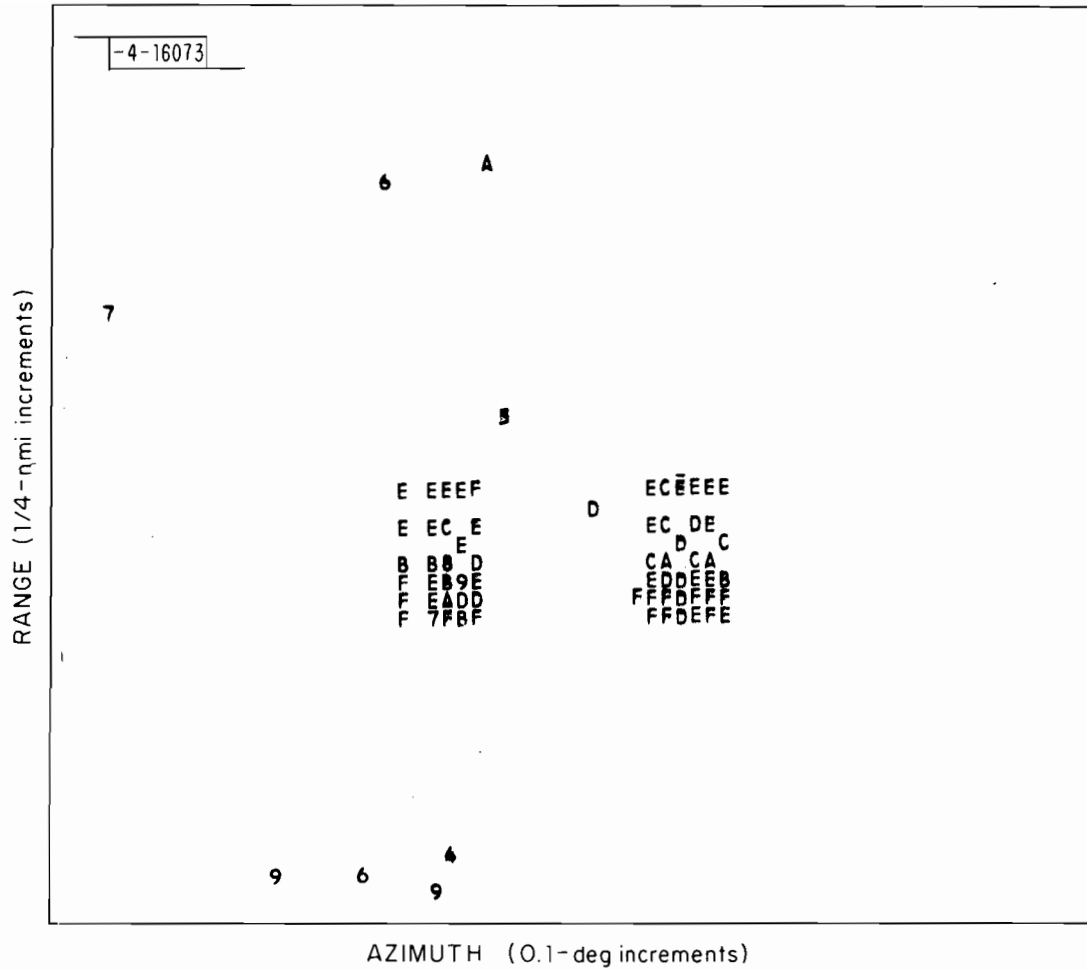

Fig. 30. Replies broken into two groups by the switch combined with shadowing of one antenna.

declared on this scan. The combination of a serrated target and potential garbling is shown in Figure 31 where the A-4 returned three groups of replies; viz., two, eight and eight, separated by two gaps each being eight replies wide. Garbling of all replies in the two larger groups is possible, as shown by overlapping replies from another aircraft at a radar range greater by one mile. Each of these groups is seen to contain six mode 3/A replies and could, therefore, have produced a target declaration. Preliminary reduction of the CD output indicates that this target was lost, as far as proper decoding is concerned.

It is equally clear that switching targets broken by shadowing of one antenna may produce appreciable azimuth jitter. The dwell time corresponds to 0.94° ; hence, when replies are broken into two groups and the target threshold T_L moves from one to the other, the azimuth will jump $\sim 0.94^\circ$ on the average.

Aircraft code 2072 with the single antenna connected was first detected at 11:10:50, when the A-4 was climbing out of PAX en route to ORF. Scope photography and decoder recording began immediately; the RAPPI coverage began at 11:15:05, as shown in Table XIV. Video recording for eight minutes began coincident with the aircraft's initial turn at ORF and an additional seven minutes of recording was carried out for the turns at SBY. The aircraft followed essentially the same path as discussed earlier and as verified in Figure 32. A synopsis of the results follows:

Table XIV. Sources of Data for the A-4 Test Flights.

SCAN	CODE	RAPPI	PICT	PHOTOS	DECODER
A-4 (2071) (Both Antennas)					
1 - 7	2071	-	-	X	X
8 - 65	2071	X	-	X	X
66 - 114	2071	X	X	X	X
115 - 197	2071	X	-	X	X
198 - 223	2071	X	X	X	X
224 - 236	2071	X	-	X	X
236 - 296	2071	X	-	-	X
297 - 301	0471	X	-	-	-
302 - 319	1471	X	-	-	-
320 - 404	0471	X	-	-	-
405 - 529	1471	X	-	-	-
A-4 (2072) (Bottom Antenna)					
1 - 26	2072	-	-	X	X
27 - 79	2072	X	-	X	X
80 - 130	2072	X	X	X	X
131 - 188	2072	X	-	X	X
189 - 228	2072	X	X	X	X
229 - 261	2072	X	-	X	X
262 - 272	1100	X	-	-	-
273 - 297	0472	X	-	-	X
298 - 397	2072	X	-	-	X
398 - 527	1172	X	-	-	X
528 - 556	0472	X	-	-	X
557 - 581	0400	X	-	-	-

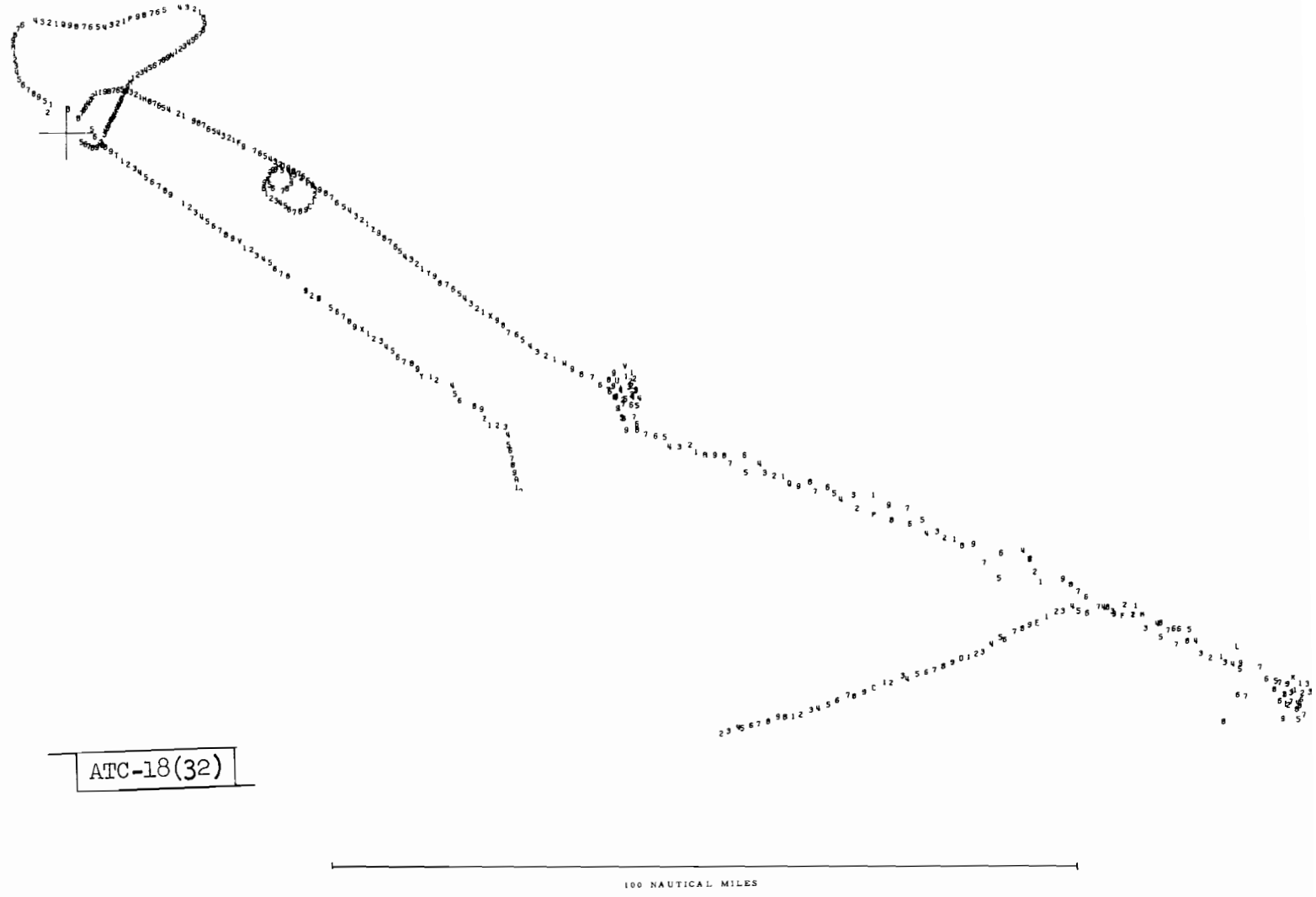

Fig. 32. En route data A-4 both antennas.

Tracking Performance for A-4 (2072) with Bottom Antenna

	<u>Scans</u>	<u>All Misses</u>	<u>Per Cent</u>
<u>Straight and Level</u>			
PXT - CCV	60	0	0.0
CCV - ORF	20	0	0.0
ORF - SBY	62	7	11.0
SBY - SIE	49	0	0.0
W107 - R4006	<u>185</u>	<u>2</u>	<u>1.0</u>
TOTAL	376	9	2.4
<u>Orbits</u>			
ORF	41	19	46.0
SBY	42	5	12.0
SIE	18	1	5.5
Descending	47	1	2.0
Climbing out	27	0	0.0

Discussion of Bottom Antenna

The performance of the tracking system was poor when the aircraft was beyond Cape Charles, which is at a range of 145 nmi from Elwood. In contrast to the test with the lobing switch, where at least some replies were received on virtually every scan, with the single antenna there are numerous scans that elicited no replies whatever. Moreover, in the 360° turns, which lasted an average of 85 seconds, the lost targets at ORF occurred in unbroken strings of five, three, four, and seven. Thus, the fraction lost, 0.46, with the single antenna is roughly twice that lost with the switching antennas and PICT data show that none of it is attributable to garbling. Run length varied in a regularly periodic fashion, as shown in Figure 33.

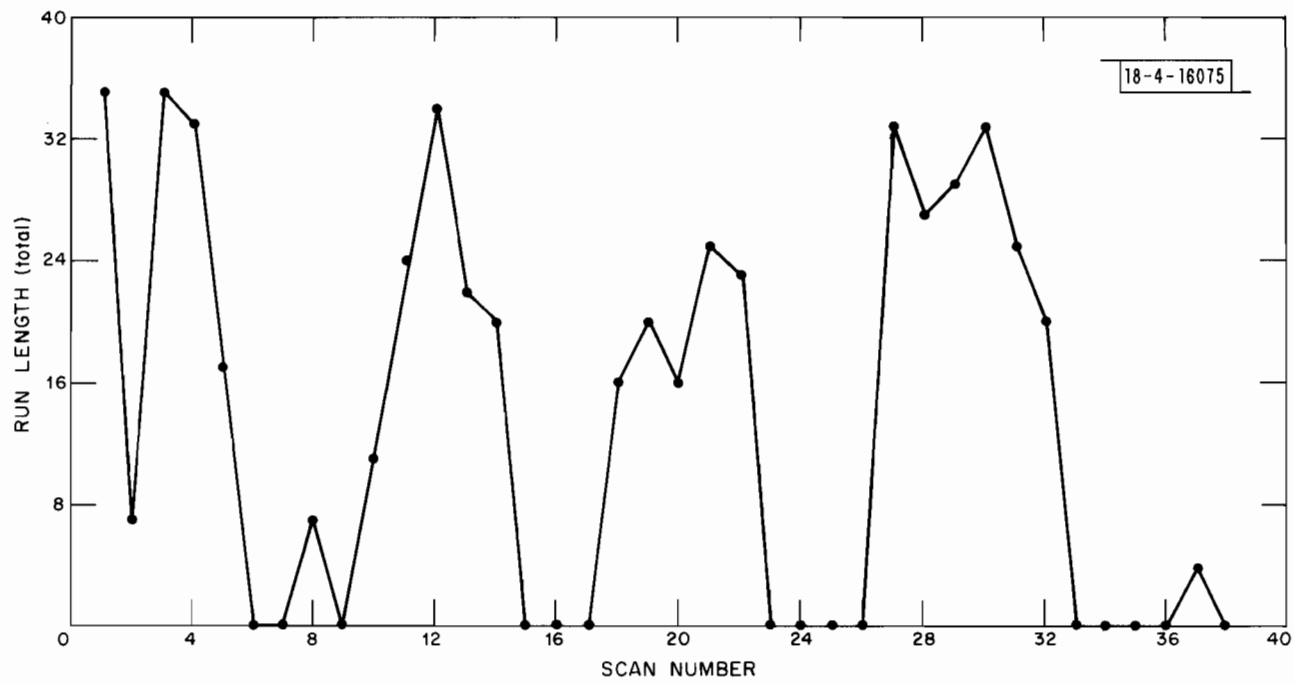

Fig. 33. Run length vs scan number for the A-4 (2072) with bottom antenna orbiting at Norfolk.

At SBY, the target was again lost in each turn at the same point, viz., when the aircraft was at the most southerly extremity -- behavior characteristic of a bottom antenna.

For that portion of the test flight beginning with the approach to SIE, including an orbit there, descent into ACY, climbout, circling in W107 and the return leg to PAX, a total of approximately 330 scans, excluding those occurring when the aircraft was overhead at Elwood, there were only six possible misses. As this portion of the flight was not covered by scope photography and most of it not by decoder, validation of those as truly lost targets is lacking but it seems clear that a minimum P_D of 98% prevailed.

Comparison of the statistics for lost targets indicates that an equal or better performance was obtained with the bottom antenna than with switching antennas except in turns at ORF. For these only, the miss rates were 46% and 25%, respectively. It can be postulated that obtaining some replies from one antenna partially overcame the effect of shadowing of the other. It is also apparent that the performance in either configuration is very poor at that location.

For periods when the FR-950 was running, the pronounced azimuth jitter observed during both flights when the aircraft was orbiting at ORF is associated with short run lengths, i.e., "chopped" targets, or serrated, i.e., "broken" targets, for the bottom or both antennas, respectively.

5. F-105

For this test, two aircraft flew in formation but the transponder in one was turned off. A miscalculation of aircraft endurance, for the altitude in question, resulted in the pilots being unable to proceed to SIE after orbiting at SBY but compelling them to return to Andrews. Lack of communication with the aircraft and with Washington Center was a particular handicap on this occasion.

The Data

The aircraft was first detected, at a range of 131 nmi, en route from ADW to ORF and squawking 2100. The discrete code, 2101, was not dialed in until the pilot had begun making 360° turns at ORF, hence confirmatory hit counts are not available for the first straight and level leg. During this portion, when both antennas were switching, 2 targets were missed out of a total of 81 scans. Figure 34 is a plot of all target declaration for this aircraft.

The overall number of lost targets is 49 out of a total of 491 scans, or 10%, most of which occurred when the aircraft was orbiting at Norfolk with the bottom antenna selected. Data for straight and level flight are limited to the ORF-SIE leg, with the bottom antenna active, during which one target was lost in 76 scans. The mission was aborted after the third turn at SBY, because of low fuel, and data gathered there for all orbits are sparse, as shown in the summary below:

ATC-18(34)

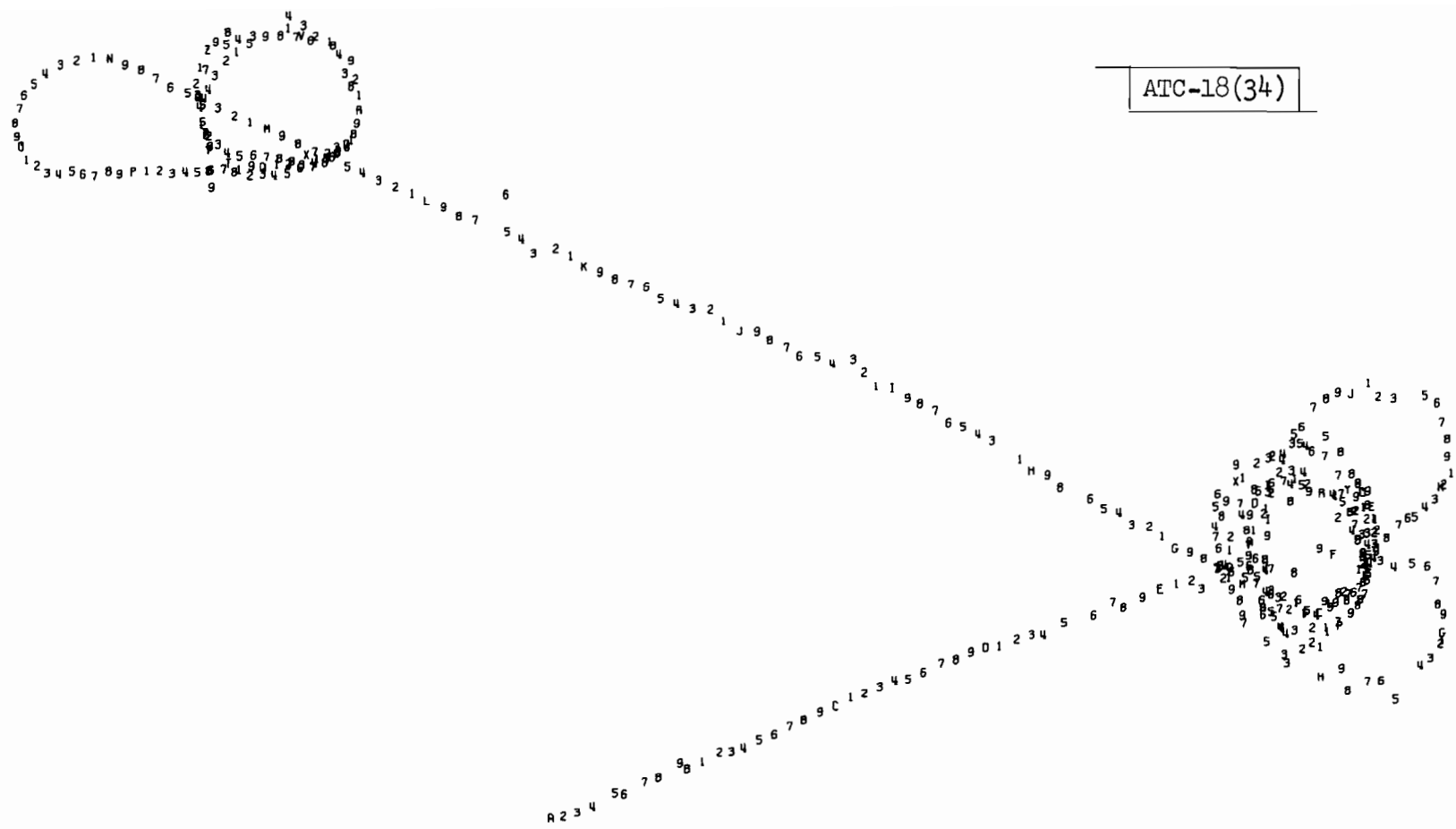

100 NAUTICAL MILES

Fig. 34. En route data F-105.

<u>Antenna</u>	<u>Scans</u>	<u>Misses</u>	<u>Per Cent Lost</u>
<u>Straight and Level</u>		0	
Bottom	76	1	1
Both	81	2	2
<u>Orbits at ORF</u>			
Bottom	72	31	43
Both	48	1	2
Top	74	6	8
<u>Orbits at SBY</u>			
Bottom	33	5	15
Both	33	0	0
Top	57	5	9

Discussion

PICT data are not available for turns at ORF and, as the pilot did not adhere to the planned sequence for antenna selection, one has only the log of voice messages to indicate which was in use at a particular time. These suggest that the sequence was both, top, and bottom. Perusal of the plots in Figures 35, 36, and 37 would suggest, on the contrary, that the sequence was both, bottom, and top because the third and fourth turns produced long strings of misses when the aircraft was generally banked so as to shadow the bottom antenna. Moreover, the first and second turns show a somewhat similar distribution of misses, albeit they are fewer; whereas the fifth and sixth turns show misses only when the aircraft is radially outbound, consistent with shadowing of the top antenna by the canopy.

The most striking feature of the data is the long period of lost targets associated with the bottom antenna when the aircraft is on the far side of a 360° turn. At ORF, the sequences were 14 and 15 consecutive misses; at

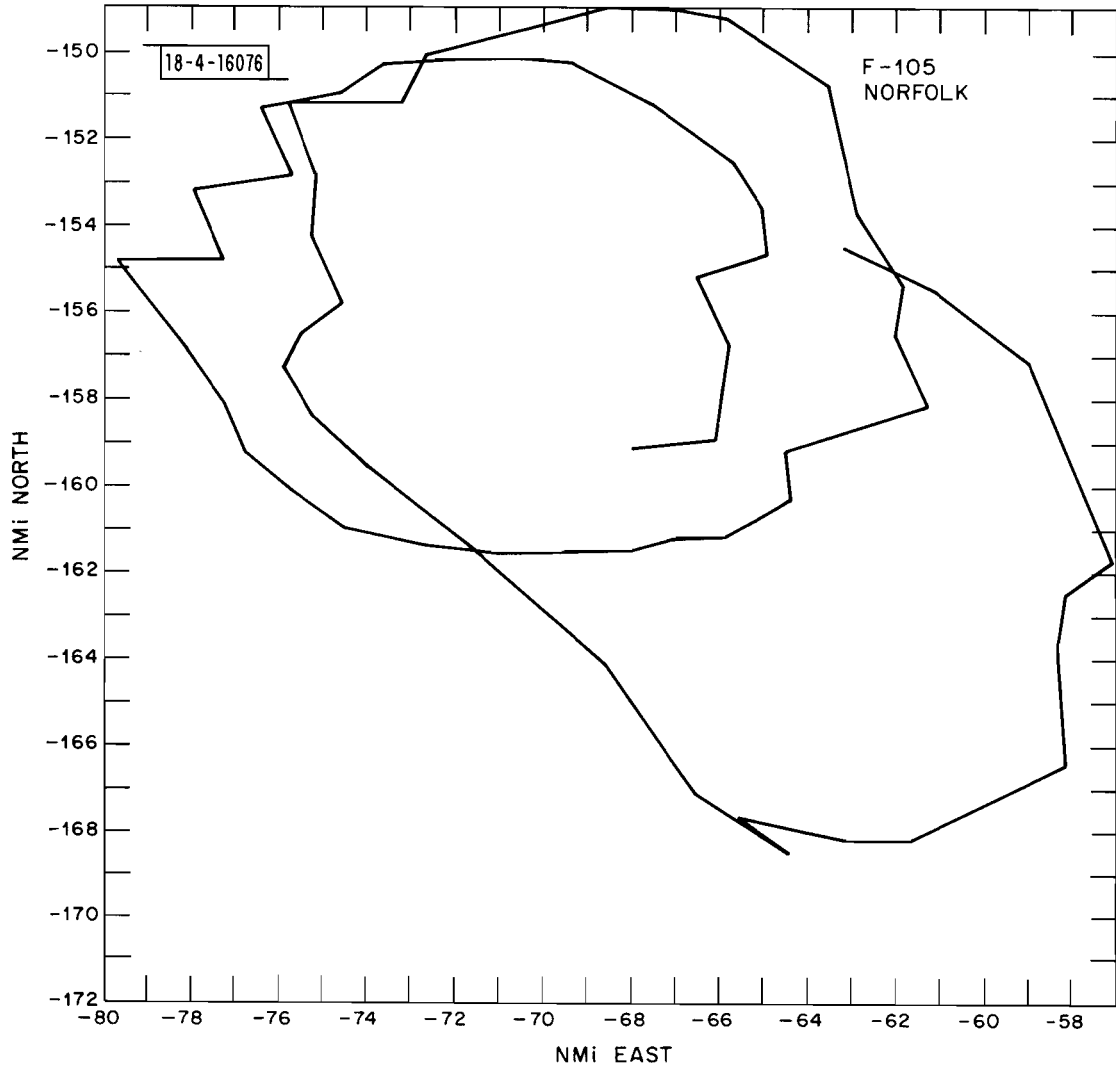

Fig. 35. F-105 aircraft in two 360° turns at Norfolk, both antennas active. Only one confirmed lost target in second turn, confirming data not available for first.

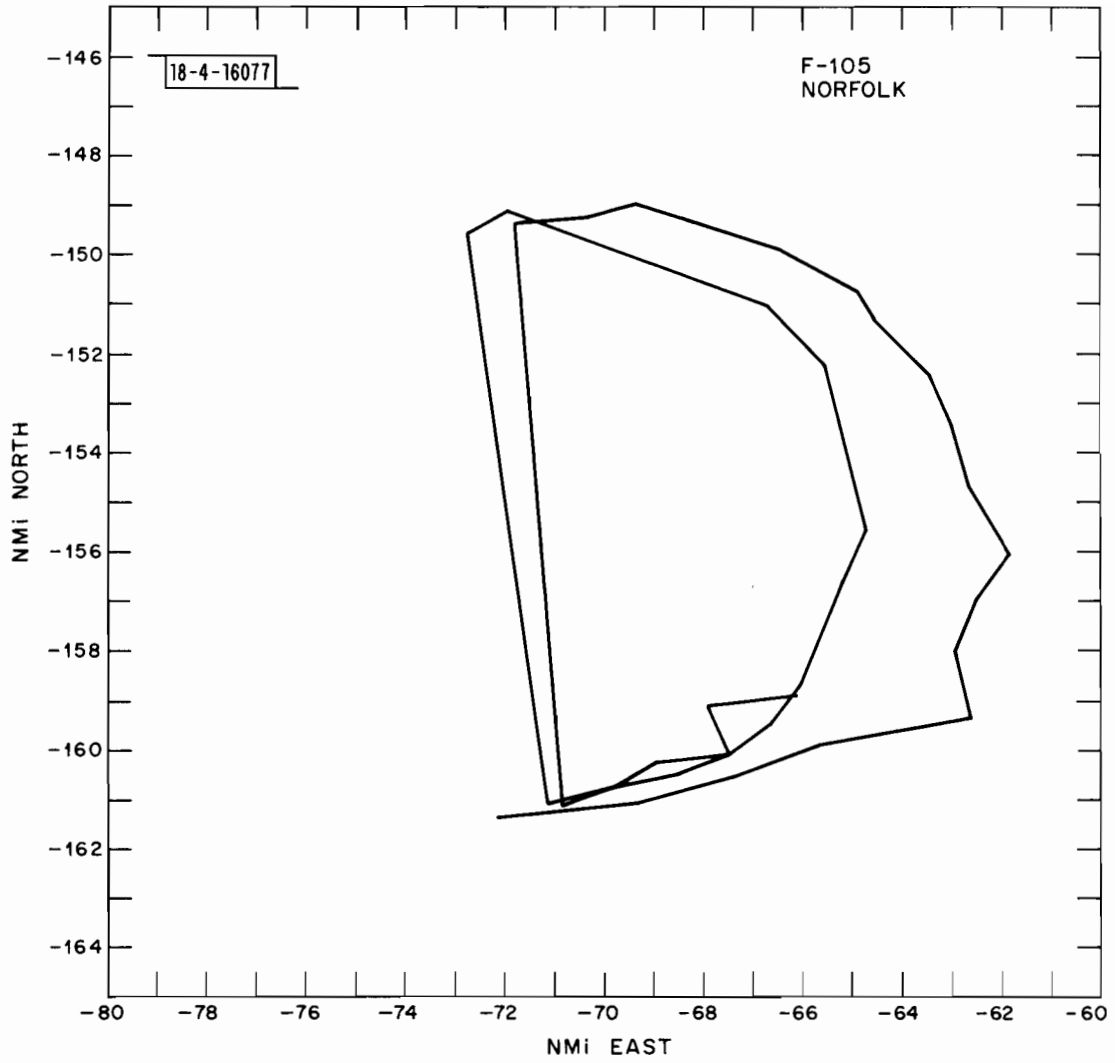

Fig. 36. F-105 aircraft in second two turns at Norfolk, where 31 lost targets occurred principally in two strings. Results are consistent with bottom antenna selection.

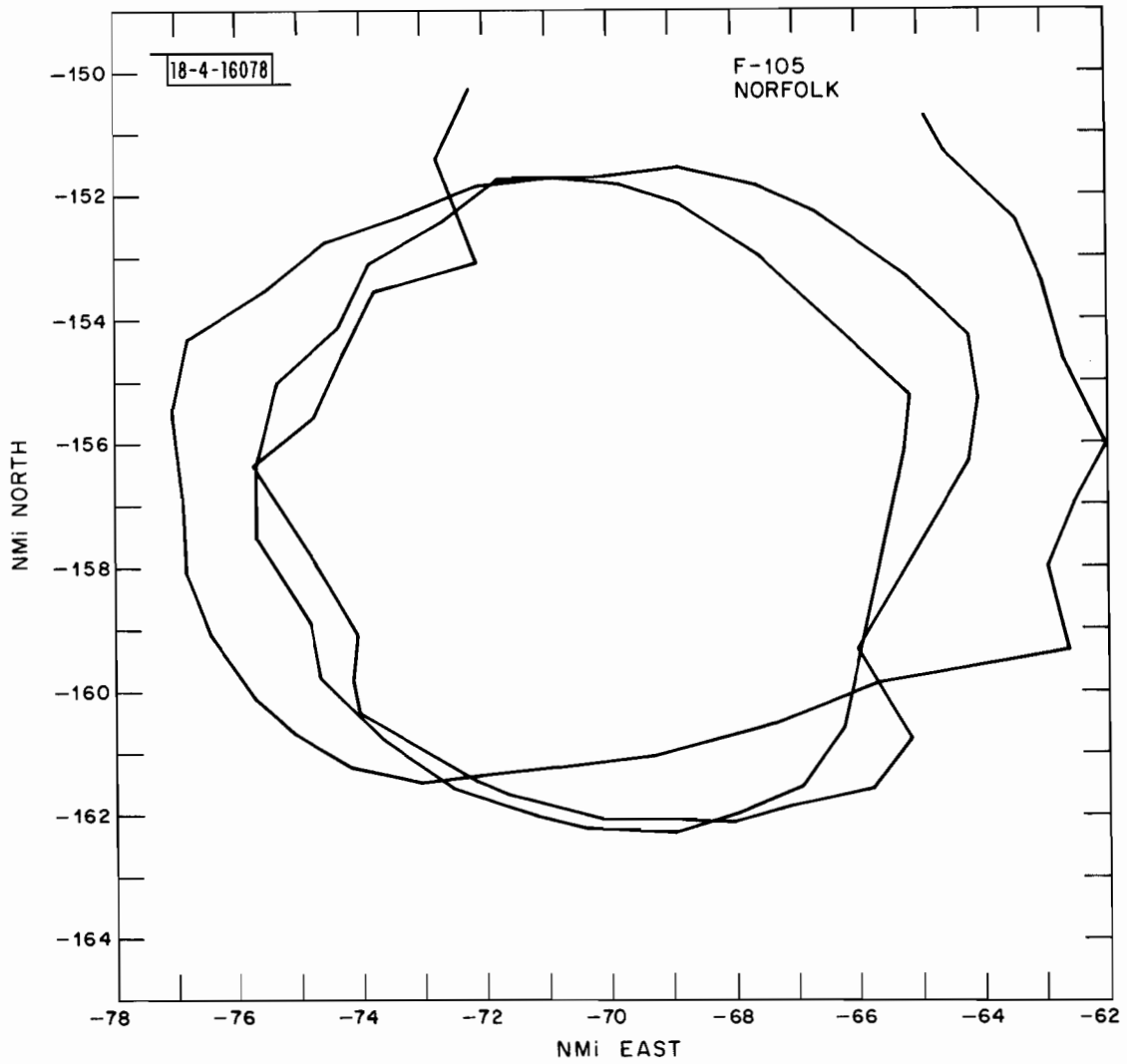

Fig. 37. F-105 aircraft in last two turns at Norfolk, where 6 targets were lost, as shown. Results are consistent with selection of top antenna.

SBY, four and six. With the top antenna, two and three consecutive misses occurred in the two turns at ORF; this antenna was not tried at SBY. For both antennas switching, the performance was greatly improved; a single confirmed miss occurred at ORF, none at SBY.

As discussed in Section II, the bottom antenna of the F-105 is flanked by large external fuel tanks and its poor coverage is entirely as expected. The data provide unequivocal evidence that the selection of both antennas, switching, is the best choice for this aircraft.

The results obtained for the F-105 compose a strong argument for the lobing switch on this particular aircraft, as they demonstrated the efficacy of a 50% duty cycle vis à vis complete and prolonged shadowing of either top or bottom antenna. By visual inspection of the aircraft, it was possible to predict that the bottom antenna would be obscured by a relatively small roll angle and top antennas in general do poorly, especially from aft aspects or in turns. On the other hand, the probability that both antennas would be obscured at the same instant is so small that their alternate activation by the lobing switch ensured maintaining an essentially continuous track with negligible misses. As run lengths averaged 40 or more hits, a single antenna is illuminated four times per scan and produces alternately three and four replies in mode 3/A; hence, the sliding window has essentially three separate opportunities for accumulating the six replies necessary to declare a leading edge on each scan.

6. C-141

Flight Profile

Because the aircraft was based at McGuire, a scant 50 nmi from Atlantic City, the approaches, missed approaches, and climbouts, with both antennas and with the bottom antenna, were executed there first. Thereafter, the aircraft performed orbits successively at Salisbury, Norfolk, Patuxent River, and Brooke, prior to a descent and landing at Andrews AFB, as the flight plan teletyped from NAFEC shows:

AFTER DEPARTING MCGUIRE, SQUAWK ASSIGNED DISCRETE CODE, WITH ALTITUDE REPORTING. SELECTING BOTH ANTENNAS, PROCEED TO SEA ISLE AT 14,000 FOR AN APPROACH TO ATLANTIC CITY (NAFEC) RWY 13/31. EXECUTE A MISSED APPROACH AT THE MAP, TURNING TO ACY R-145 AND CLIMBING OUT TO 14,000 IN W-107 FOR A SECOND APPROACH WITH BOTTOM ANTENNA SELECTED. AGAIN EXECUTE A MISSED APPROACH, DESCENDING TO A MINIMUM ALTITUDE OF 2000 BEFORE CLIMBING OUT ON ACY R-145 TO FL270 IN W-107. PROCEED TO SALISBURY AND EXECUTE SIX 360 DEGRE TURN AS FOLLOWS: TWO WITH BOTTOM ANTENNA, TWO WITH BOTH, TWO WITH TOP ANTENNA. WITH BOTTOM ANTENNA SELECTED PROCEED TO NORFOLK VORTAC AND REPEAT THE SIX TURNS IN THE SAME ORDER, REPORTING TO WASHINGTON CENTER WHEN INITIATING AND COMPLETING THE TURNS. PROCEED TO PATUXENT VORTAC WITH BOTH ANTENNAS SELECTED AND EXECUTE A THIRD SET OF SIX TURNS. PROCEED TO BROOKE VORTAC WITH BOTTOM ANTENNA SELECTED AND EXECUTE A FOURTH SET OF TURNS. WITH BOTH ANTENNAS SELECTED, EXECUTE AN APPROACH TO ANDREWS IL OR 19R, EXECUTING A MISSED APPROACH AT THE

MAP, DESCENDING TO A MINIMUM ALTITUDE OF 1000, TURNING TO NOTTINGHAM AT 3000, SELECTING THE BOTTOM ANTENNA FOR A SECOND APPROACH AND MISSED APPROACH. CLIMB OUT, AS CONTROLLED, AT MAXIMUM RATE OF CLIMB, TO 10,000 OR ABOVE FOR A RETURN TO MCGUIRE. NOTES: IMPORTANT THAT TRANSPONDER BE CHECKED OUT BEFORE FLIGHT AND THAT SAME DISCRETE CODE BE RETAINED THROUGHOUT THE TEST, IF POSSIBLE.

The above-described plan was further elucidated after the crew was in radio contact with NAFEC radar. It was considered highly desirable to gather both terminal and En Route data during this test flight, which was the only one scheduled for a large transport. Consequently, when it was realized that the time expended in making a large number of three-minute turns would reduce that available in the Washington area, it was decided to execute a total of three at each of the locations: ORF, PXT, and BRV. Six turns were executed at SBY, however.

The Data

A tabulation of sources of data and corresponding times is shown in Table XV. Coverage with the RAPPI was withheld for some 57 minutes, in the middle of the test, in order to employ it in tracking an F-105. Both video data and scope photographs are available for much of that period, however, to verify the DRANDA indication of lost targets. Partly because of its origination, the C-141 test flight was the most productive of any conducted against the Elwood site and the en route data, plotted in Figure 38, include maneuvers in the Washington area. Continuous DRANDA data were obtained for a period of three hours 28 minutes; 507 PPI scans were photographed; 65% of the test time was covered by the decoder-recorder, 85% by the RAPPI printout. Con-

Table XV. Sources of Data for En Route Test of C-141.

SCANS	START TIME	CODE	ANTENNA	RAPPI	PICT	PHOTOS	DECODER
1-19	12/11/16	2005	Both	-	-	-	-
20-36	12/14/26	2005	Both	X	-	-	-
37-101		1105	Both	X	-	-	-
102-280		0405	Both	X	-	-	-
281-493		0405	Bottom	X	-	-	X
494-550		2105	Bottom	X	-	-	X
551-620		2105	Bottom	-	-	-	X
621-669	13/50/05	2105	Bottom	-	-	X	X
670-694		2105	Bottom	-	X	X	X
695-730		2105	Both	-	X	X	X
731-744	14/07/36	2105	Both	-	-	X	X
745-756		2105	Both	-	X	X	X
757-809		2105	Top	-	X	X	X
810-824		2105	Top (?)	-	X	X	X
824-832		2105	Top (?)	-	-	X	X
833-891		2105	Bottom	-	-	X	X
892-897		2105	Bottom	-	X	X	X
898-918	14/34/29	2105	Bottom	X	X	X	X
919-943	14/37/50	2105	Both	X	X	X	X
944-975	14/41/51	2105	Top	X	X	X	X
978-979		2105	Both	X	-	X	X
980-1055	14/47/37	2105	Both	X	-	X	X
1055-1072	14/59/38	2105	Bottom	X	-	X	X
1073-1086		2105	Both	X	-	X	X
1086-1110	15/04/36	2105	Top	X	-	X	X
1111-1173	15/08/37	2105	Bottom	X	-	X	X
1174-1189	15/18/52	2105	Both	X	-	X	X
1190-1221		2105	Top	X	-	X	X
1222-1234		2105	Both	X	-	X	X
1235 1257	15/28/39	2105	Both	-	-	X	X

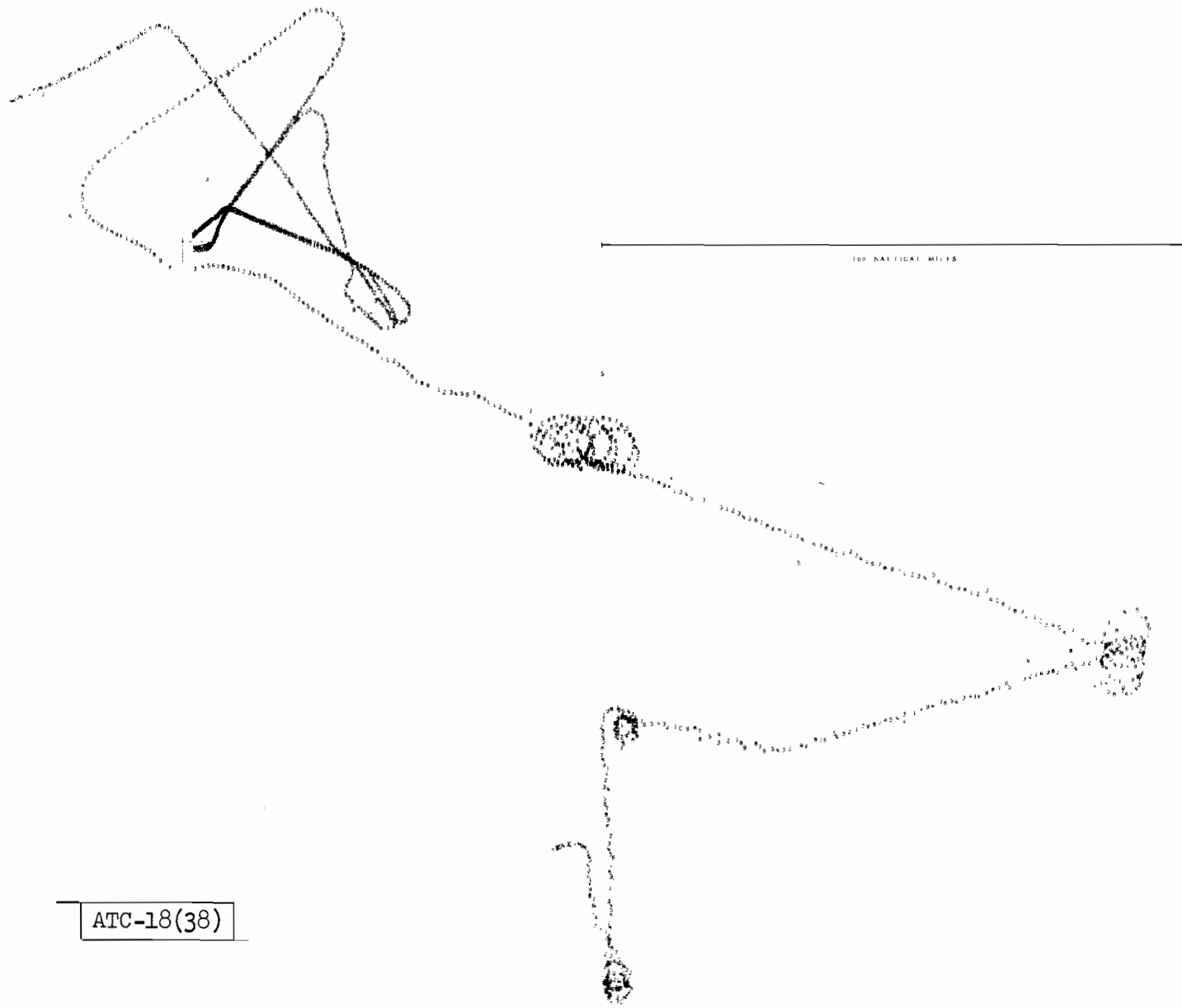

Fig. 38. En route data C-141.

sidering all scans during which beacon replies were being received at Elwood, there is an upper limit of 5% misses overall. Of this total, only one-third are confirmed lost targets, suggesting that an overall detection probability of ~98% may have obtained.

Considering only those periods during which RAPPI was available, one arrives at the results shown in Table XVI, where numbers in parentheses are lost targets not verified by hit counts.

Turns at SIE were standard holding patterns made prior to the descent to ACY. The constant bank angle turns performed at SBY are plotted in Figures 39, 40, and 41, reconstructed from DRANDA. (The plots also contain obviously erroneous azimuths for several target declarations.) As shown in Table VIII, however, only five targets were lost in all turns in a total of 179 scans. No situations that could have produced serious garbling appear to have occurred and only one scan, shown in Figure 42, showed the serrations caused by shadowing of one antenna when both were active.

Table XVI. Tracking Performance for C-141 Aircraft.

	<u>Scans</u>	<u>Misses</u>	<u>Per Cent Lost</u>
<u>Straight and Level</u>			
Both Antennas			
W-107-SIE	110	(3)	(3)
ORF-PXT	78	0	0
Totals	188	(3)	(1.6)
Bottom Antenna			
W-107 - Elwood	54	(3)	(6)
SBY-ORF	57	0	0
Totals	111	(3)	(2.7)
<u>360° 30°-Bank Angle Turns</u>			
Bottom Antenna			
SIE	60	(5)	(8)
SBY	63	3	5
ORF	27	3	11
PXT	19	0	0
Totals	169	6-(11)	3.5 - (6.5)
Both Antennas			
SIE	60	(2)	(3)
SBY	63	0	0
ORF	24	0	0
PXT	15	0	0
Totals	162	(2)	(1.2)
Top Antenna			
SBY	53	2	4
ORF	32	4	13
PXT	24	3	12
Totals	109	9	8

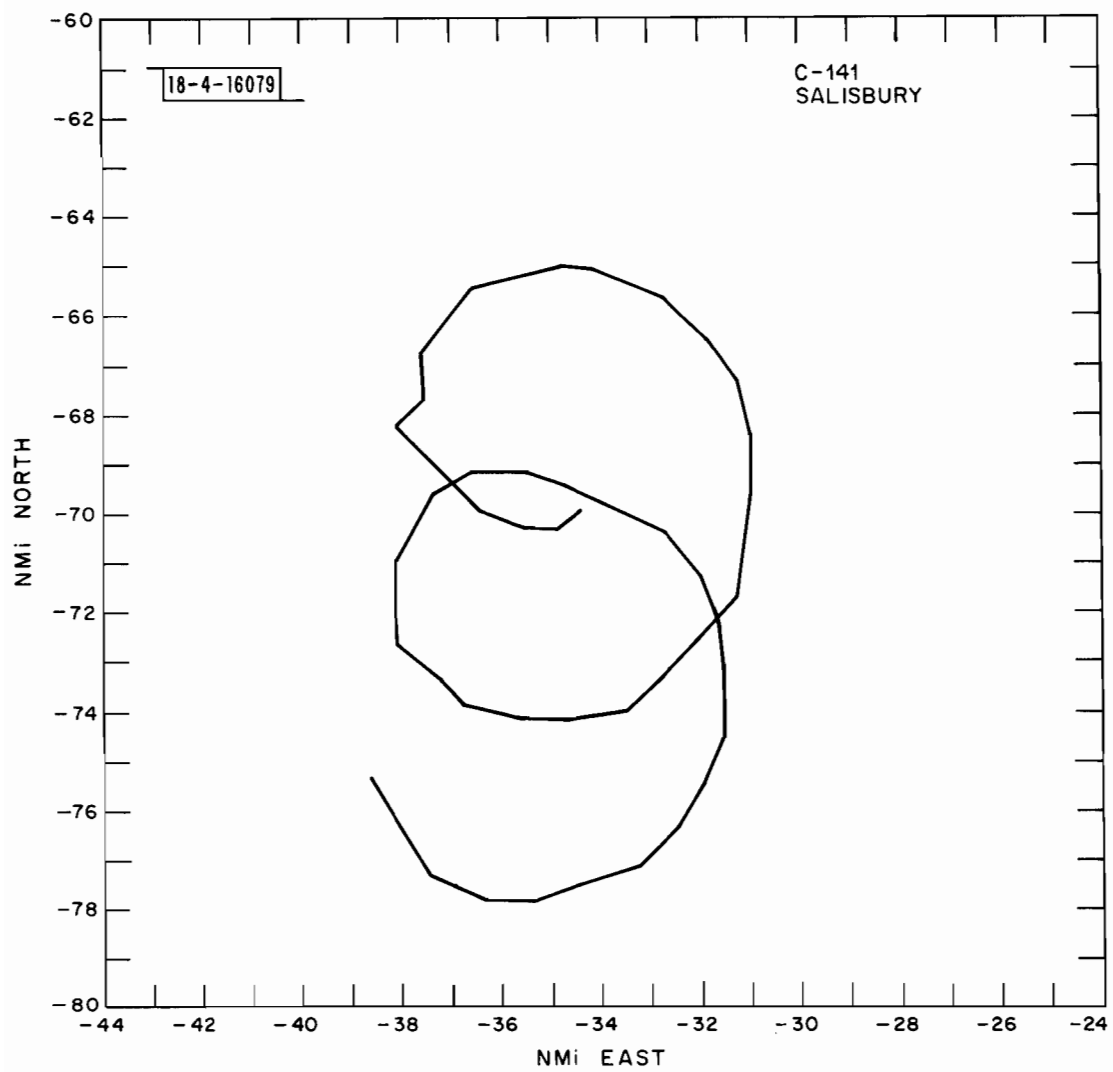

Fig. 39. C-141 in turns at Salisbury with bottom antenna.

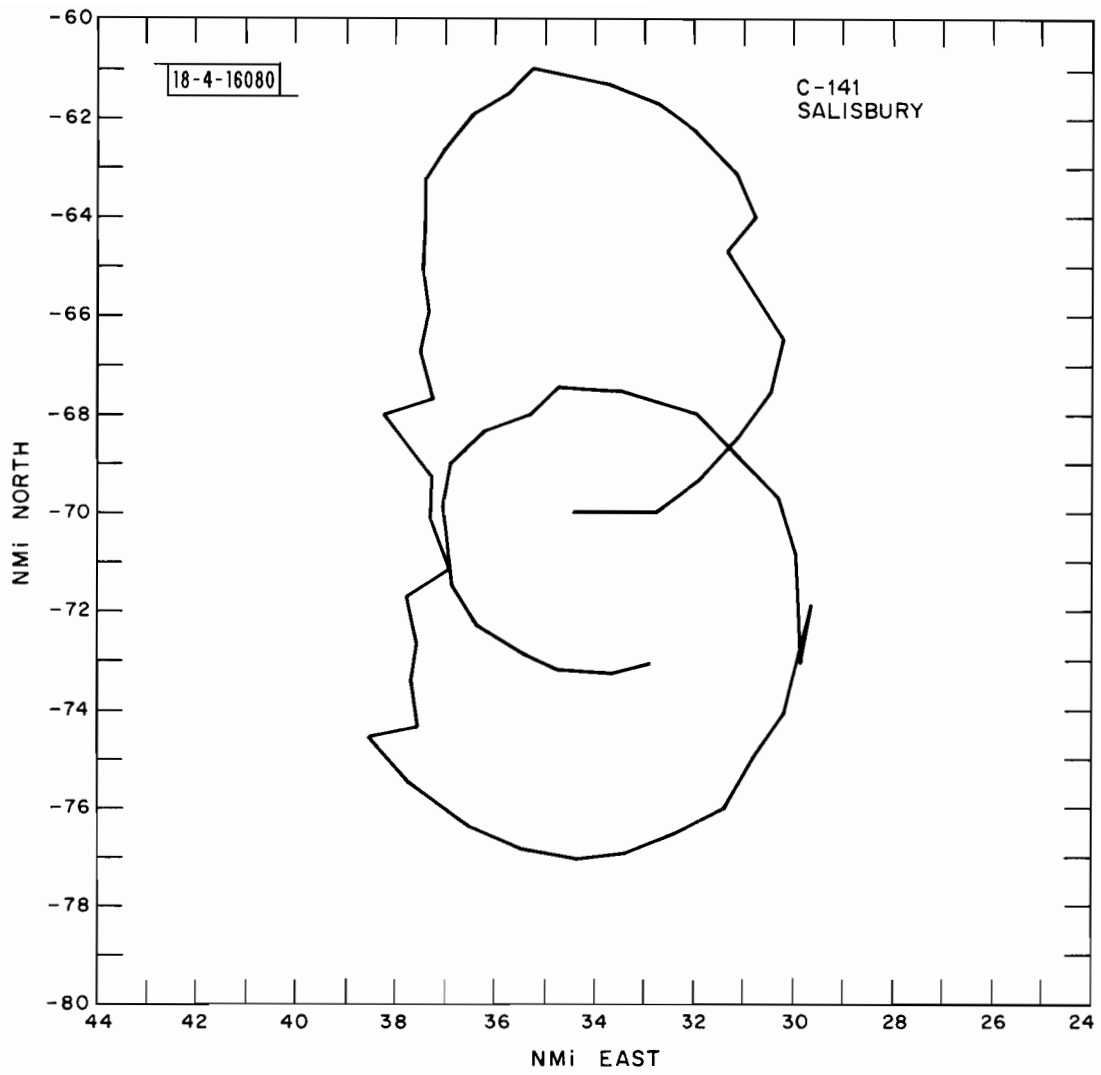

Fig. 40. C-141 in turns at Salisbury with both antennas.

IV. SUMMARY

En Route data were collected on six, and terminal data on seven, types of military aircraft as a basis for comparing the beacon detection performance obtainable with the bottom antenna with that provided by both antennas connected to a lobing switch. Data of each kind were gathered over periods of the order of one to two hours, for each aircraft type, during which the aircraft flew a variety of maneuvers intended to exercise a wide range of aspect angles. Information derived from the ARTS III extractor includes details of each beacon reply and provides confidence in the values for probability of detection contained in Section III. En Route data are more sparse, not only because of the lower sampling rate, 6 rpm vs 15 rpm antenna rotation rate, but also because the use of a variety of codes, including nondiscrete codes, by each aircraft as it crossed center and sector boundaries, made recovery of the data very difficult, and beyond the resources of the project in some cases. Moreover, the PCD has no equivalent to an extractor and individual beacon replies are, therefore, unavailable for analysis in this test series. Only through great care and not a small amount of detective effort were enough data validated to be able to reach conclusions.

Results of the several tests, based simply on probability of detection, are displayed in Table XVII. Blank spaces in Table XVII are those cases for which there were no data taken on one or both antenna configurations. Hence, no comparison of the switched versus the bottom only configuration can be made.

Table XVII. Preferred Antenna Configurations.
(Based on probability for target detection)

	PCD*		ARTS > 25 nmi		ARTS < 25 nmi	
	S&L	Turns	S&L	Turns	S&L	Turns
T-29	E	E	E	E		()
T-39	E	S	(+)	(+)	E	()
F-106	E	S	B	B		
A-4	B	S	B	S		E
F-105	E	S	B	E		
C-141	()	S	()	E		
C-1				S	E	()

S&L - straight and level flight

S - switched between top and bottom antennas (>85% confidence)

B - bottom only antenna (>85% confidence)

E - about equal performance from both configurations

() - test data are inclusive at 85% confidence level

*No appreciable difference in performance was discerned as a strong function of range from the sensor, for the PCD data.

+Though substantial amounts of T-39 data were obtained, the results were ambiguous and difficult to interpret. Section III discusses several reasons why the data were felt not to be truly indicative of system performance.

The () in the table indicates that after the data were edited to remove ambiguities, the remaining data were insufficient to express a statistically confident conclusion.

The notations S (switched) and B (bottom only) indicate that with 85% or greater confidence, the given antenna configuration gave higher detection probability. The E (equal) indicates that the two antenna configurations perform about equally with respect to probability of detection. Data are too sparse to permit general application of a higher confidence limit.

These data suggest that, with a few exceptions,

- a. The switched configuration is preferred En Route with the PCD for its higher detection probability. It is best for turns and probably not significantly different from bottom only for straight and level flight.
- b. The bottom antenna configuration shows the higher probability of detection in the terminal (ARTS) areas.

Although target detection is the primary criterion on which to base a conclusion regarding the preferred transponder antenna, two other criteria have also been used in comparing the data, viz. azimuth jitter and consecutive misses. A quantitative comparison of the effects of switching antennas versus a bottom antenna on azimuth jitter in ARTS III data was presented in Section III. B. It shows that the bottom antenna produced the smaller azimuth jitter for the five types of aircraft for which an appreciable difference could be discerned. The comparisons were made of data collected when the aircraft

were in turns as this is when more replies are lost and consequent jitter is anticipated. En Route data, as shown in Figure 19, also substantiate the expectation of greater jitter being produced by the switch. With both ARTS III and the PCD, however, a maximum standard deviation of 0.5 degree applies.

Consecutive misses, on the other hand, were more likely for the bottom antenna than for the switch. An extreme example is the En Route data for the F-105 at 175 nmi where 14 and 15 consecutive misses occurred in two turns for the former whereas two consecutive misses occurred in each of two turns with the latter. Consecutive misses in the terminal area data, presented in the discussion of each aircraft test flight, corroborate this tendency on the part of the bottom antenna. It should also be remembered that the defruiter contributes to the poor performance of the switch in the terminal area.

Thus, we would conclude that the En Route (PCD) results favor the switched configuration, on the basis of all criteria applied. For ARTS, the bottom only configuration gave higher average detection performance, but the continuous sequence of misses on turns would be more detrimental to the tracker and subsequently cause more dropped tracks. If one considers that random misses on straight and level flights of 5 - 10% or so rarely cause good trackers to drop tracks, the choice for ARTS would hinge on just the turn performance. Then we note that only for the F-106 does the bottom antenna alone give higher probability of detection. (15% vs 7% for the switch.) However, the run lengths of misses tend to be shorter than those for the bottom only antenna, hence even for the F-106 one might well prefer the switch in the terminal area.

To sum up, just on the basis of the data given here, if one had to choose between using the switched antennas or using the bottom antenna only, the choice would clearly favor the switch for the En Route (PCD), and would probably also favor it for the terminal (ARTS) based largely on the effect that runs of misses have an automatic tracking.

Perhaps even more important is the observation that differences between aircraft types with their variety of antenna installations, different switching frequencies, different sensitivity thresholds, etc. is often much more important than whether the switched antennas or just the bottom only antenna is used.

V. RECOMMENDATIONS

There are several recommendations that can be made as a result of the work done so far.

1. There is evidence that use of the switched antennas has a greater (deleterious) effect on ARTS than on the PCD. Since there are never-the-less advantages in using the switch, it is felt that the defruiter and declaration thresholds in ARTS III should be analyzed in detail to improve their performance with the switched antennas. The faster rotation rate of the terminal interrogator provides fewer pulses for detection than are available to the PCD. This may result in less margin, when using the switch, for loss of pulses due to suppression, or loss of signal strength. The programmable nature of the ARTS III target detector would permit some small changes that would appear tentatively from our data to enhance its performance vis a vis the switched antenna.
2. The A-4 aircraft exhibits very poor beacon detection performance, on turns with either configuration, ~20% loss of replies, both with ARTS and with the PCD. It is suggested that this aircraft be singled out for special attention. The slow speed switch which it uses, and the other aircraft do not, may be the cause.

3. The F-105 bottom mounted antenna is effectively shielded between wing tanks, etc., and its performance is quite poor ($\sim 20\%$ misses on turns with either antenna configuration and 30% En Route with bottom only). It is recommended that this aircraft be examined to see if relocating the bottom antenna is feasible. Use of the switch configuration is preferable to use of the bottom only antenna as it is now installed.
4. A number of cases, from Table XVII, either were not tested, or did not result in sufficient data to yield high confidence conclusions. It is recommended that these cases be considered again, in relation to their deficiency ranking, Table III, to see if further tests are warranted. If further tests are run, a higher yield of good data can be ensured if tighter control over the test variables can be exercised. Numerous examples of this have been given in Section III.
5. One point this test series did not address directly was any comparison of the effect of different interrogation interlace patterns. FAA En Route sites commonly use a different interlace pattern than joint FAA/USAF En Route sites. Some data were collected, and discussed in Appendix B, indicating that a given switching frequency may work better with one interlace than with another. This is an area where some further measurements are needed to fully resolve the issue.

6. There is evidence to indicate that if PCD threshold levels could be reduced somewhat, detection performance against the switched configuration would be enhanced. Some testing is needed to verify this gain especially as compared with the possible increase in false targets that could accrue.
7. A dual-input transponder that automatically selects the better antenna is presumed to excel over any other arrangement and some supporting ARTS III evidence is available in Section III.B on the C-1 equipped with Hartlobe. No En Route data were obtainable, however, and it is therefore not possible to show convincingly the improvement to be gained. By equipping, on an experimental basis, some of the most troublesome aircraft with a dual-input transponder, it would be possible to provide this information. This kind of a temporary modification can be implemented without difficulty on at least some of the same types of aircraft as those already tested.

REFERENCES

- [1] B. Rubinger, "Controller Reported Performance Defects in the ATC Radar Beacon System (1971 Survey)," report prepared for Beacon System Interference Problem Subgroup, (July 1972).
- [2] C. Chapman, "Performance of the Radar Video Data Processor When Beacon Transponder Is Alternately Switched Between Top and Bottom Aircraft Antennas," FAA Report on Project 231-001-02X (September 1966).
- [3] R.E. Britton, "Performance of Transponder Lobing Switch Against Certain ATC Automatic Beacon Target Processors," Project 499L (AIMS), System Engineering Group, WPAFB (June 1967).
- [4] R.L. Lella, "Evaluation of the 1968 FAA/DOD Beacon Flight Test in New York," FAA-RD 70-60 (September 1970).
- [5] G.E. Hart, et al, "The Hartlobe Airborne Dual Antenna System for IFF, Part 1 - Mark X (SIF) System" NRL Report 6401 (October 1966).
- [6] J.E. Blazej, "Technical Evaluation of Dual-Input Transponder," FAA-RD-71-18 (April 1971).
- [7] "Subprogram Design Logic for PECO DRANDA," IBM/FAA SINE-5280-2 (10 November 1969).
- [8] "System Design Data for Transmitting Set, Coordinate Data AN/FYQ-47, -48, and -49," Burroughs Corp., D-774A (19 July 1968).
- [9] "Coder-Decoder Group, AN/GPA 122," T.O. 31P4-2GPA-122-2.
- [10] C.V. Galante, "Report of Test to Assess SAGE Performance When Aircraft Transponder is Switched Between an Upper and Lower Antenna (Ping Pong)," Surveillance and Instrumentation SPO Report ESD TR-72-32 (October 1972).
- [11] A.G. Cameron, D.H. Pruslin, "Empirical Assessment of ATCRBS," Project Report ATC-16, M.I.T. Lincoln Laboratory FAA-RD-73-139 (Oct. 31, 1973).

APPENDIX A

ARTS-III DATA ON LOST TARGETS

From the reduced ARTS-III extractor, one obtains a complete record of all replies that were received from a specified aircraft with data on time, range, azimuth, and code, for each. A complete tabulation of the reply sequences pertaining to scans when a target was not declared is contained in this appendix in order to show the effects of shadowing and of antenna switching. The reply pattern is simply a representation of the individual hits, in mode A or C, received in one scan, with the number missing given as an integer.

F-105 TEST DATA: 11/2/72 TAPE VOLUME I

TIME (GMT)	REPLY PATTERN	ANT. CONFIG.	MANEUVER	APPROX. p, θ, h	COMMENTS
1837/44 /52 /56 3838/04 /08	A AA A A 9 A 7 AA AAC AAC 7 ACA A AA	SWITCHED ↓	CLIMBING AWAY ↓ LEVEL LEVEL	p θ h (k) 16 180 — 16 180 — 16 180 16 18 180 ↓ 18 180 ↓	
/20 /59 41/32 /36 42/54	ACAA C A CA 6 A AA 7 AAC A A 6 A A 6 ACA	SWITCHED ↓	LEVEL LEVEL TURN ↓	20 180 16 24 170 ↓ 42 150 ↓ 42 150 ↓ 48 160 ↓	
43/15 /19 /27 /35 /43	A 7 AAC 7 ACA A 7 AA 7 AAC A 8 ACA 6 ACA A 7 AA 7 AAC ACA 5 AA A	SWITCHED ↓	TURN ↓ ↓ ↓	47 160 16 47 ↓ ↓ 47 ↓ ↓ 46 ↓ ↓ 45 ↓ ↓	
/50 /54 /58 44/02 /06	A 7 AA A A 6 A AA AC 7 ACA ACA A 6 ACAA	SWITCHED ↓	TURN ↓ ↓ ↓	44 160 16 44 ↓ ↓ 43 ↓ ↓ 43 ↓ ↓ 42 ↓ ↓	
1845/48 /52 /56 46/00 /12	A 8 A A A C 5 C AA 7 AAC A A 6 ACAA AA 6 CAAC 6 AA	SWITCHED ↓	TURN ↓ ↓ ↓	41 150 16 42 150 ↓ 42 150 ↓ 43 140 ↓ 44 150 ↓	
1846/44 47/03 /07 /11 /15	ACA 6 ACA AA 7 AA A 6 A AA ACA 6 A AA ACA 6 A A	SWITCHED ↓	TURN ↓ ↓ ↓	48 150 16 49 ↓ ↓ 49 ↓ ↓ 48 ↓ ↓ 49 ↓ ↓	0000 DECLARED ON 3 SCANS (207, 308, 210)
47/19 /51 48/01 /14 /18	AC 5 C ACA AC 7 ACA 6 ACA AAC 6 AAC A AA ACA 6 AC A	SWITCHED ↓	TURN ↓ AVOIDING TRAFFIC AVOIDING TRAFFIC	49 150 16 47 160' ↓ 46 160 ↓ 45 160 ↓ 44 160 ↓	
48/26 /30 /34 /38 49/33	AAC 5 C NONE A 7 AA A AA ACA 6 ACA	SWITCHED ↓	LEVEL ↓ ↓ ↓	43 160 16 43 160 ↓ 42 160 ↓ 42 160 ↓ 36 150 ↓	SOME MANEUVERING TO AVOID TRAFFIC AT TIMES ↓
1849/37 /41 /45 53/13 /17	AC 7 ACA 6 A AAC 7 AC A AA 7 AAC NONE NONE	SWITCHED ↓ — —	LEVEL LEVEL LEVEL TURN TURN	36 150 16 35 150 ↓ 35 150 ↓ 36 120 ↓ 36 120 ↓	SOME MANEUVERING TO AVOID TRAFFIC AT TIMES

F-105 TEST DATA: 11/2/72 TAPE VOLUME I (Continued)

TIME (GMT)	REPLY PATTERN	-ANT. CONFIG.	MANEUVER	APPROX. p, θ , h			COMMENTS
				p	θ	h (k)	
53/21 /25 /29 /37 /41	NONE A_C AACAAC NONE NONE	———— ———— BOTTOM ↓	TURN ↓ ↓	37 37 37 38 38	120 ↓ ↓ ↓ ↓	16 ↓ ↓ ↓ ↓	
1853/49 /53 /57 54/01 /05	NONE ↓	BOTTOM ↓	TURN ↓ ↓	37 ↓ ↓ ↓ ↓	130 ↓ ↓ ↓ ↓	16 ↓ ↓ ↓ ↓	
/09 /13 /17 /20 /23	NONE ↓	BOTTOM ↓	TURN ↓ ↓	37 36 ↓ ↓ ↓	130 ↓ ↓ ↓ ↓	16 ↓ ↓ ↓ ↓	
1854/32 /52 /56 /59 55/03	A_AAC AA A___C AACAC_C NONE	BOTTOM ↓	TURN ↓ ↓	36 34 33 33 33	130 ↓ ↓ ↓ ↓	16 ↓ ↓ ↓ ↓	
55/07 57/45 58/16 /36 /40	ACA NONE C NONE NONE	BOTTOM ↓	TURN ↓ ↓	32 39 40 39 39	130 120 120 130 120	16 ↓ ↓ ↓ ↓	SCAN 377: 11 of 11 379: 15 of 15 385: 8 of 9 387: 7 of 7
58/48 /52 /56 59/00 /04	NONE ↓	BOTTOM ↓	TURN ↓ ↓	38 38 37 37 37	130 ↓ ↓ ↓ ↓	16 ↓ ↓ ↓ ↓	
1859/11 /15 1902/28 /32 /40	AA NONE ↓	BOTTOM ↓	TURN ↓ ↓	36 36 42 42 42	130 130 110 110 120	16 ↓ ↓ ↓ ↓	
02/44 04/06 /10 /14 08/58	NONE NONE NONE C A	BOTTOM ↓	TURN LEVEL ↓	42 38 38 37 44	120 130 130 130 180	16 ↓ ↓ ↓ ↓	VERTICAL LOBE IN INTERROGATOR PATTERN?

F-105 TEST DATA: 11/2/72 TAPE VOLUME I (Continued)

TIME (GMT)	REPLY PATTERN	ANT. CONFIG.	MANEUVER	APPROX. p, θ, h			COMMENTS
				p	θ	h (k)	
09/02	AC	BOTTOM	TURN	44	180	16	
/10	NONE	↓	TURN	44	180	↓	
/14	NONE	↓	TURN	44	180	↓	
10/13	C__C	↓	ALMOST LEVEL	42	190	↓	
/17	NONE	↓	ALMOST LEVEL	42	190	↓	
13/30	NONE	BOTTOM	TURN	37	220	16	
14/44	CAA	↓	↓	44	220	↓	
15/00	CAA	↓	↓	46	220	↓	
/24	AACAAC	↓	↓	47	220	↓	
/36	AC_A	↓	↓	47	210	↓	
16/03	NONE	BOTTOM	TURN	46	210	16	
/11	↓	↓	↓	45		↓	
/15	↓	↓	↓	44		↓	
/19	↓	↓	↓	43		↓	
1916/23	NONE	BOTTOM	TURN	43	210	16	
/34	A_A	↓	↓	42		↓	
/38	NONE	↓	↓	41		↓	
/46	NONE	↓	↓	40		↓	
/50	A_AAC	↓	↓	40		↓	
16/54	NONE	BOTTOM	TURN	39	210	16	
/58	A	↓	↓	39	210	↓	
19/36	AA_AA	↓	↓	45	220	↓	
20/11	NONE	↓	↓	46	210	↓	
/27	ACAA__CA	↓	↓	45	210	↓	
20/31	AACAAC	BOTTOM	TURN	45	210	16	
/35	NONE	↓	↓	44		↓	
/39	NONE	↓	↓	44		↓	
/43	NONE	↓	↓	43		↓	
/47	NONE	↓	↓	42		↓	
20/51	NONE	BOTTOM	TURN	42	210	16	
/55	NONE	↓	↓	41	210	↓	
/59	NONE	↓	↓	41	210	↓	
21/02	A_AACA	↓	↓	41	210	↓	
/10	NONE	↓	↓	40	210	↓	
1921/30	NONE	BOTTOM	TURN	39	210	16	
/34	AA_A	BOTTOM	↓	38	210	↓	
23/20	ACA_6_ACA	SWITCHED	↓	40	220	↓	
/24	A_AA_4_AAC	↓	↓	40	220	↓	
24/31	A_5_A_AA	↓	↓	46	210	↓	
1924/35	A_A_4_CAAC	SWITCHED	TURN	46	210	16	
/43	AC_7_ACA	↓	↓	46	210	↓	
/55	A_A_5_AACAA	↓	↓	45	210	↓	
25/18	A_A_6_ACAA_4_AA	↓	↓	43	200	↓	
/26	AAC_6_AAC	↓	↓	43	200	↓	TRK CORRELATED

F-105 TEST DATA: 11/2/72 TAPE VOLUME I (Continued)

TIME (GMT)	REPLY PATTERN	ANT. CONFIG.	MANEUVER	APPROX. p, θ, h			COMMENTS
				p	θ	h (k)	
26/02	ACA	SWITCHED	TURN	38	200	16	
/10	NONE	↓	↓	37	200	↓	
/57	AA			36	210		
27/44	AC__7__A			40	220		
/48	ACA__6__A_A			40	220		
/52	AA_A_C_4_A			41	220		

F-105 TEST DATA: 11/2/72 TAPE VOLUME II

TIME (GMT)	REPLY PATTERN	ANT. CONFIG.	MANEUVER	APPROX. p, θ, h			COMMENTS
				p	θ	h (k)	
1929/03	ACA__6__A	SWITCHED	TURN	47	210	16	
/15	ACA__6__A	↓	↓	47	210	↓	
/27	A_AA			46	210		
/31	NONE			46	200	↓	
/34	A_AA__7__A			46	200		
29/38	AA__5__A_AA	SWITCHED	TURN	45	200	16	
/42	A__5__A_AA	↓	↓	45	↓	↓	
/50	A_AA__7__AAC			44	↓	↓	
/54	AA__7__AA			44	↓	↓	
30/02	AA__7__AAC			43	↓	↓	
30/06	AAC	SWITCHED	TURN	42	200	16	
/10	AAC__5__C	↓	↓	42	↓	↓	
/18	AAC__6__AA_A			41	↓	↓	
/49	ACAA			38	↓	↓	
/53	NONE			37	↓	↓	
30/57	ACA_C_AC	SWITCHED	TURN	37	200	16	
32/24	A	TOP	↓	37	220	↓	
33/07	NONE	↓	↓	41	↓	↓	
/11	NONE			41	↓	↓	
/15	CAA_A			42	↓	↓	
1936/16	A_AACA	TOP	TURN	29	210	16	
37/24	A_AACAA	↓	↓	41	220	↓	
/32	A__C			42	↓	↓	
/36	NONE			43	↓	↓	
/40	NONE			43	↓	↓	
1937/47	ACAACA	TOP	TURN	44	220	16	
/51	NONE	TOP	↓	44	220	↓	
41/01	A_AAC	SWITCHED	↓	41	210	↓	
/12	NONE	↓	↓	41	210	↓	
43/07	NONE			51	210	↓	

F-105 TEST DATA: 11/2/72 TAPE VOLUME II (Continued)

TIME (GMT)	REPLY PATTERN	ANT. CONFIG.	MANEUVER	APPROX. p, θ , h			COMMENTS
				p	θ	h (k)	
43/11 /34 /38 /42 /46	NONE A__5__A_AA AACAA AACAA A__5__AACAA	SWITCHED ↓	TURN ↓	51 53 ↓ ↓	210 ↓ ↓	16 ↓ ↓	
44/41 /45 /53 /57 45/01	A_A__6__ACA ACA__6__ACA ACA__6__AC A__9__C AC__5__CAA	SWITCHED ↓	TURN ↓	51 51 50 49 49	200 ↓ ↓	16 ↓ ↓	SYNC. GARBLE
45/09 /13 /36 /40 /44	AAC__5__CA_C AAC__7__AC AACAA__5__AC A__8__AC AAC__7__ACA	SWITCHED ↓	TURN TURN LEVEL ↓	47 47 45 44 44	200 ↓ ↓	16 ↓ ↓	
45/48 46/27 /59 47/07 /11	AC__6__AAC__5__C_AC AACA AC__5__C_ACA AC__AA_AACA NONE	SWITCHED ↓	LEVEL ↓	44 39 35 35 34	200 210 ↓	16 ↓ ↓	
1947/15 /50 /54 48/26 /49	A_A ACA__A A_AACAA AC__C__C_A_A AC	SWITCHED ↓	LEVEL ↓ TURN	34 30 29 26 23	210 210 210 220 220	16 ↓ ↓	
1953/43 54/14 56/51 /55 57/34 59/33	NONE A_AACAA AAC__6__AAC A__8__ACAA__5__AC A_AA AA_AA_A_C	SWITCHED ↓	LEVEL SLOW TURN TURN TURN DECENDING LEVEL	14 15 12 12 10 6	60 60 10 10 10 30	8 5 2 2 2 2	
59/37 /41 2000/52 01/31 02/46	NONE A AA__8__AC AAC__6__AAC AC	SWITCHED ↓	LEVEL LEVEL TURN TURN TURN	6 6 11 12 11	30 40 50 40 10	2 2 3 3 3	
2002/50 05/11 /19 /31 /35	A A_AA_A A__CAACAA AACAAC AAC	SWITCHED ↓	TURN DECENDING ↓	11 3 3 2 2	10 0 0 0 0	3 1 1 1 1	

T-29 TEST DATA: 10/25/72 TAPE VOLUME I

TIME (GMT)	REPLY PATTERN	ANT. CONFIG.	MANEUVER	APPROX. p, θ, h			COMMENTS
				p	θ	h (k)	
1719/27 /43 20/30 21/53	NONE NONE NONE A_A_CAAC	BOTTOM ↓	STRAIGHT ↓ TURN	2 3 5 7	50 50 70 90	?	ASCENDING
37/32 38/39 41/08 44/52 /56	NONE A_C_AC C NONE A	BOTTOM BOTTOM ? SWITCHED SWITCHED	TURN TURN ? TURN TURN	38 39 40 37 38	150 150 140 150 150	12.0 	Repositioning for drift
45/00 /04 /08 /12 /16	AC AA A_A A_AA CA	SWITCHED ↓	TURN ↓	38 38 38 37 37	150 ↓ ↓ ↓ ↓	12.0 ↓ ↓ ↓ ↓	
45/20 /31 /43 /47 /51	AACA_6__AC ACA_C__C_A CA__6__A A_AA AC__5__C	SWITCHED ↓	TURN ↓	37 37 38 38 38	150 ↓ ↓ ↓ ↓	12.0 ↓ ↓ ↓ ↓	
45/55 /59 46/11 /19 /23	AAC__A_AA A_A_C C__C__AA_AA ACA__6__A AAC	SWITCHED ↓	TURN ↓	38 38 38 37 37	150 ↓ ↓ ↓ ↓	12.0 ↓ ↓ ↓ ↓	
1746/26 /30 /34 /38 /42	A__7__AA A_A AC A__7__AAC A__AA	SWITCHED ↓	TURN ↓	37 ↓ ↓ ↓ ↓	150 ↓ ↓ ↓ ↓	12.0 ↓ ↓ ↓ ↓	
46/46 /50 47/14 /25 /29	NONE ACA__6__ACA ACA__6__A_A AA__5__A_AAC A_A__6__A_A	SWITCHED ↓	TURN ↓	38 ↓ ↓ ↓ ↓	150 ↓ ↓ ↓ ↓	12.0 ↓ ↓ ↓ ↓	
49/39 /43 /47 50/42 /46	A_AAC_CA NONE ACA NONE NONE	TOP ↓	TURN ↓	37 37 36 37 37	150 ↓ ↓ ↓ ↓	12.0 ↓ ↓ ↓ ↓	

T-29 TEST DATA: 10/25/72 TAPE VOLUME I (Continued)

TIME (GMT)	REPLY PATTERN	ANT. CONFIG.	MANEUVER	APPROX. ρ , θ , h			COMMENTS
				ρ	θ	h (k)	
51/09 /25 /37 /41 /45	NONE A_AACAA NONE NONE NONE	TOP ↓ ↓ ↓ ↓	TURN ↓ ↓ ↓ ↓	37 38	150	12.0	
51/49 /53 /57 52/08 /12	NONE AAC_AC A_CAACA ACAA NONE	TOP ↓ ↓ ↓ ↓	TURN ↓ ↓ ↓ ↓	38 37 37 37 38	150	12.0	
1752/48 /56 53/00 /04 /08	NONE ↓ ↓ ↓ ↓	? ↓ ↓ ↓ BOTTOM	? ↓ ↓ ↓ ↓	38 38 37 37 37	150	12.0	Changing to Bottom-Only?

*The T-29 replied to mode C interrogations with brackets only. The altitude at ρ 25 miles was held constant at 12,000 ft (as reported by the pilot).

T-29 TEST DATA: 10/25/72 TAPE VOLUME II

TIME (GMT)	REPLY PATTERN	ANT. CONFIG.	MANEUVER	APPROX. ρ , θ , h			COMMENTS
				ρ	θ	h (k)	
1810/18 13/46 14/49 /53 15/59	A_4_AA_A AAC_6_AAC ACA_C__AC AA_6_CAAC C__7_A_A	BOTTOM SWITCHED ↓ ↓ ↓	TURN ↓ ↓ ↓ ↓	32 31 31 30 30	210	12*	
16/58 17/34 19/31 20/38 21/45	A__AA_ACA_C A__ACAACA CA_A A ACAA__A_A	SWITCHED ? TOP TOP TOP	TURN ? TURN TURN TURN	30 29 27 27 27	210	12*	Being repositioned
22/52 23/43 /47 /51	A A NONE NONE NONE	TOP ? ↓ ↓ ↓	TURN - - - -	27 25 25 25 25	210	12	
25/13 /17 28/53 42/44 48/55	NONE A AACAA AACAAAC A_AACA_C	SWITCHED ↓ ↓ ↓ ↓	TURN TURN STRAIGHT STRAIGHT TURN	21 21 14 7 14	220	?	

T-29 TEST DATA: 10/25/72 TAPE VOLUME II (Continued)

TIME (GMT)	REPLY PATTERN	ANT. CONFIG.	MANEUVER	APPROX. ρ , θ , h			COMMENTS
				ρ	θ	h (k)	
49/15 /19 /23	NONE ↓	SWITCHED ↓	TURN ↓	14 14 14	190 190 190	? ↓	

*The T-29 replied to mode C interrogations with brackets only. The altitude at $\rho > 25$ miles was kept constant at 12,000 ft (as reported by the pilot).

T-29 TEST DATE: 10/25/72 TAPE VOLUME III

TIME (GMT)	REPLY PATTERN	ANT. CONFIG.	MANEUVER	APPROX. ρ , θ , h			COMMENTS
				ρ	θ	h (k)	
1917/24	NONE	SWITCHED	TURN	13	180	?	

F-106 TEST DATA: 11/5/72 TAPE VOLUME I

TIME (GMT)	REPLY PATTERN	ANT. CONFIG.	MANEUVER	APPROX. ρ , θ , h			COMMENTS
				ρ	θ	h (k)	
1412/47 /51 /55 15/09 /13	A__CAA_AA_ A_AACA_C CAACAA ACA_6__A_AA AC__8__C	SWITCHED ↓	LEVEL ↓ TURN TURN	37 37 37 39 39	130 130 130 150 150	16 ↓ ↓ ↓	
15/22 /33 16/01 /13 /16	NONE ACA A_A_6__ACAA A__ACA A__AACAAC	SWITCHED ↓	TURN ↓	40 41 41 40 38	150 ↓ ↓	16 ↓ ↓	
16/36 /40 /44 /48 /53	C_A A_A AAC_6__A AC A_A_6__ACAA	SWITCHED ↓	TURN ↓	39 40 40 41 41	150 ↓ ↓	16 ↓ ↓	
17/59	ACA_6__AC	SWITCHED	TURN	41	150	16	

F-106 TEST DATA: 11/5/72 TAPE VOLUME II

TIME (GMT)	REPLY PATTERN	ANT. CONFIG.	MANEUVER	APPROX. p, θ, h			COMMENTS
				p	θ	h (k)	
1427/17 /37 /41 /45 /49	ACAA AACAAAC NONE ACAA A_AA_AAC	SWITCHED ↓	LEVEL ↓	32 32 32 33 33	210 210 210 220 220	16 ↓ ↓ ↓ ↓	
25/57 28/01 30/17 /39 /44	NONE NONE A_6_A_AA_6_C ACA_6_AA AACAA_7_CA	SWITCHED ↓	LEVEL LEVEL TURN ↓	33 33 37 36 37	220 220 220 230 230	16 ↓ ↓ ↓ ↓	
31/04 /08 Not a /51 miss 32/26 /35	AAC_5_G AA_7_AAC ACAAC_C A_A_5_AACAA_5_AC ACAA	SWITCHED ↓	TURN ↓	38 39 36 38 39	230 230 220 220 220	16 ↓ ↓ ↓ ↓	10 other replies lost due to sync. garble
32/43 33/14 /18 /30 /42	ACA C_ACA_A_A C_8_CA_6_ACAA AACAA_7_C A_AAC_5_C	SWITCHED ↓	TURN ↓	38 36 35 36 37	220 220 220 230 230	16 ↓ ↓ ↓ ↓	
34/01 35/16 /20 48/28 49/07	AACAA A AA_AAC A_AA ACAACA	SWITCHED ↓	TURN LEVEL LEVEL CLIMBING CLIMBING	38 1 33 20 25	220 210 210 160 160	16 16 16 7 12	
1449/11 50/03 /56 51/00 /05	CAAC AACAA AAC_5_GAA NONE NONE	SWITCHED ↓	CLIMBING CLIMBING CLIMBING CLIMBING LEVEL	26 23 41 42 42	160 160 160 170 170	12 18 22 22 23	

F-106 TEST DATA: 11/5/72 TAPE VOLUME II (Continued)

TIME (GMT)	REPLY PATTERN	ANT. CONFIG.	MANEUVER	APPROX. p, θ , h			COMMENTS
				p	θ	h (k)	
51/10	ACAA	SWITCHED	CLIMBING	433	170	24	
1500/52	NONE	BOTTOM	TURN	41	160	16	
02/35	ACAACA	↓	↓	43	150	↓	
06/20	CAAC_A			47			
06/24	A_AACA	BOTTOM	TURN	47	150	16	
/28	NONE	↓	↓	47	↓	↓	
/31	C_C			48			
/35	ACAA			47			
/39	AC_CAAC			47			
11/31	A_CAA	BOTTOM	TURN	45	190	15	
16/11	AA_AACA	BOTTOM	TURN	39	230	16	

T-39 TEST DATA: 7/25/72 TAPE VOLUME I

TIME (GMT)	REPLY PATTERN	ANT. CONFIG.	MANEUVER	APPROX. p, θ , h			COMMENTS
				p	θ	h (k)	
1839/58	AA_4_AACAA	BOTTOM	TURN	5	30	2	
41/40	AACA_C_C	↓	STRAIGHT, LEVEL	6	110	5	
46/40	A_CA_AA_AAC_A		STRAIGHT, ASCEND	27	120	12	
/55	AA_CAA		↓	29	130	12	
47/15	A_A_AAC_C			30	130	13	
47/19	C_CAAC_5_C	BOTTOM	STRAIGHT, ASCEND	30	130	13	
/23	A_4_AAC_CA	↓	STRAIGHT, ASCEND	31	↓	13	
/35	A_CAA_A		STRAIGHT, ASCEND	32		13	
48/54	A_CA_CA_A		TURN	36		14	
50/16	AA_4_A_A_AACA_C		STRAIGHT, LEVEL	34	↓	16	
52/42	A_4_C_A_AA	BOTTOM	STRAIGHT, LEVEL	38	120	16	
53/17	CAACA	↓	↓	↓	130	↓	
/21	A_A						
/25	AC						
/29	NONE						
53/33	NONE	BOTTOM	STRAIGHT, LEVEL	38	130	16	
/37	C	↓	↓	↓	↓	↓	
/41	A						
/45	NONE						
/52	C_ACA_AA						
54/21	C_CA_5_AA	BOTTOM	STRAIGHT, LEVEL	38	130	16	
56/30	CA_CAA_6_C	↓	STRAIGHT, LEVEL	38	150	↓	
57/25	A_A_7_AA_AA		TURN	39	160	↓	
58/40	C_C_A_AA		STRAIGHT, LEVEL	36	↓	↓	
/44	A_7_A_A		STRAIGHT, LEVEL	36	↓	↓	

T-39 TEST DATA: 7/25/72 TAPE VOLUME II

TIME (GMT)	REPLY PATTERN	ANT. CONFIG.	MANEUVER	APPROX. p, θ , h			COMMENTS
				p	θ	h (k)	
1942/23	NONE	BOTTOM	TURN	5	20	33	
43/07	A___ACA	↓	↓	7	40	2	
46/27	CA	↓	↓	12	140	11	
/47	A_6__C__C	↓	↓	14	150	16	
49/21	ACA__5_A_C_A	↓	↓	27	150		
54/02	ACA	?	TURN	36	120	16	
/06	AAC	?	↓	37	110	↓	
/10	A_A__8__AA	?	↓	37	110		

T-39 TEST DATA: 7/25/72 TAPE VOLUME III

TIME (GMT)	REPLY PATTERN	ANT. CONFIG.	MANEUVER	APPROX. p, θ , h			COMMENTS
				p	θ	h (k)	
0258/28	A_AA	?	TURN	36	110	16	
/32	AA_A	?	TURN	36	110	16	Changing code to 0414
0302/39	A_A__ACAAC__A	SWITCHED	STRAIGHT, LEVEL	32	140	16	
0310/24	NONE	SWITCHED	STRAIGHT, LEVEL	10	190	3	
/28	A_AAC	SWITCHED	STRAIGHT, LEVEL	10	190	3	

T-39 TEST DATA: 7/25/72 TAPE VOLUME IV

TIME (GMT)	REPLY PATTERN	ANT. CONFIG.	MANEUVER	APPROX. p, θ , h			COMMENTS
				p	θ	h (k)	
0333/16	?	SWITCHED	TURN	14	130	6	
37/47	NONE	↓	TURN	34	160	16	
43/39	A_A__ACA__AC	↓	STRAIGHT, LEVEL	35	110	↓	
44/02	NONE	↓	TURN	36	110		
/06	NONE	↓		36	110		
44/10	AACA	SWITCHED	TURN	36	110	16	
46/28	AA__AACAA	↓	STRAIGHT, LEVEL	37	130	↓	
49/52	NONE	↓	TURN	37	120		
/56	NONE	↓	TURN	37	130		
50/00	NONE	↓	TURN	37	120	↓	
50/08	NONE	SWITCHED	TURN	37	120	16	

T-39 TEST DATA: 7/25/72 TAPE VOLUME V

TIME (GMT)	REPLY PATTERN	ANT. CONFIG.	MANEUVER	APPROX. p, θ , h	COMMENTS
0404/53	AC__CAACA	TOP	STRAIGHT, LEVEL	p θ h (k) 15 190 3	
/57	NONE	↓	↓	15 190 3	
17/39	(AC---11---C C C---) C__C__C__A	↓	↓	8 190 2	

A-4 TEST DATA: 10/27/72 TAPE VOLUME I

TIME (GMT)	REPLY PATTERN	ANT. CONFIG.	MANEUVER	APPROX. p, θ , h	COMMENTS
17/49/59	NONE	BOTTOM	STRAIGHT, ASCEND	p θ h (k) 32 160 4	
17/50/19	NONE	↓	STRAIGHT, ASCEND	30 ↓ 5	
17/51/ 6	NONE	↓	STRAIGHT, LEVEL	25 ↓ 10	
/18	A	↓	↓	24 ↓ 10	
/26	A_A__A_CAAC	↓	↓	24 ↓ 10	
17/51/29	A__ACA_C	BOTTOM	STRAIGHT, LEVEL	23 160 10	
/37	A	↓	↓	22 170 ↓	
/41	ACA_CA__A	↓	↓	22 170 ↓	
17/53/ 4	ACAA	↓	TURN	23 180 15	
17/53/ 8	NONE	↓	TURN	23 180 15	
17/53/12	NONE	BOTTOM	TURN	24 180 15	
/16	NONE	↓	TURN	24 180 16	
/59	ACAACA	↓	STRAIGHT, LEVEL	27 170 ↓	
17/54/46	A__C	↓	STRAIGHT, LEVEL	30 170 ↓	
17/56/19	NONE	↓	TURN	39 150 ↓	
17/56/23	AC_AA	BOTTOM	TURN	39 150 16	
/27	NONE	↓	↓	39 ↓ ↓	
/51	A_CA_C	↓	↓	38 ↓ ↓	
17/57/54	NONE	↓	↓	39 ↓ ↓	
17/57/58	NONE	↓	↓	39 ↓ ↓	
17/58/ 1	NONE	BOTTOM	TURN	39 150 16	
17/58/ 5	NONE	↓	↓	↓ ↓ ↓	
17/59/16	ACAAC	↓	↓	↓ ↓ ↓	
/20	NONE	↓	↓	↓ ↓ ↓	
/24	NONE	↓	↓	↓ ↓ ↓	
17/59/25	NONE	BOTTOM	TURN	39 150 16	
/44	C	↓	↓	39 ↓ ↓	
18/ 0/38	A__5__A	↓	↓	40 ↓ ↓	
/42	ACA	↓	↓	40 ↓ ↓	
/46	NONE	↓	↓	40 ↓ ↓	

A-4 TEST DATA: 10/27/72 TAPE VOLUME I (Continued)

TIME (GMT)	REPLY PATTERN	ANT. CONFIG.	MANEUVER	APPROX. p, θ, h			COMMENTS
				p	θ	h (k)	
18/ 0/50	A_AA	BOTTOM	TURN	40	150	16	SYNC. GARBLED. NOT COUNTED.
18/ 1/ 2	A_AACAA			39	150	15	
18/1/30-1/53	?			38	150	15	
18/ 7/15	A__A			34	220	16	
18/ 7/19	NONE	BOTTOM	TURN	34	220	16	
/23	NONE			35	220		
/27	NONE			35	220		
18/ 8/22	NONE			40	230		
18/ 8/30	NONE			40	230		
18/10/ 8	NONE	BOTTOM	TURN	39	230	16	
18/10/16	NONE			40	230		
18/10/55	A			36	220		
18/11/ 3	NONE	BOTTOM	TURN	36	220	16	
/ 7	A_AA			35	220		
/27	A_A_C_A__C_A			36	230		
/54	NONE			39	230		
/58	AACAAC			9	220		
18/12/ 2	AACAA			BOTTOM	TURN	39	
/34	A__AA_AAC	36	220				
/53	A	35	220				
/57	NONE	35	220				
18/13/32	AC_ACA__A	39	230				
18/13/36	NONE	BOTTOM	TURN	39	230	16	
/40	NONE			39	220		
18/14 0	A_A			38			
/ 4	A_A__A			37			
/ 8	C__C__C_A			37			
18/14/12	A__AA_A_A	BOTTOM	TURN	36	220	16	
/39	NONE			35	230		
/43	NONE			36	220		
/47	NONE			36	220		
/55	NONE			36			
18/14/59	A_A__CA	BOTTOM	TURN	37	230	16	
18/15/45	A_AACA			STRAIGHT, LEVEL	35	220	
/49	NONE		35	220			
/53	C		35	220			
18/16/ 9	NONE		34	210			
/28	ACAACA		34	210			

A-4 TEST DATA: 11/3/72 TAPE VOLUME I

TIME (GMT)	REPLY PATTERN	ANT. CONFIG.	MANEUVER	APPROX. ρ , θ , h			COMMENTS
				ρ	θ	h (k)	
16/24/22 /26 /30 /34 /42	ACAACA AACAAC ACAACA AACAA__11____A AA__A_A_C_A	SWITCHED ↓	STRAIGHT, LEVEL ↓	53 53 52 52 51	140 140 ↓ ↓ ↓	16 16 ↓ ↓ ↓	
16/24/45 /49 /53 /57	ACAACA AA_AA AACAAC CAACA	SWITCHED ↓	STRAIGHT, LEVEL ↓	51 51 50 50	140 140 ↓ ↓	16 16 ↓ ↓	
16/25/ 5 /17 16/26/59 16/28/45 /49	ACA_CA AACA_CA A_AAC__C A__C_ACAA A_AACAA	SWITCHED ↓	STRAIGHT, LEVEL ↓ TURN ↓	49 49 41 40 40	140 140 150 160 160	16 16 ↓ ↓ ↓	
16/28/57 16/29/ 1 / 5 / 9 /13	ACAACA AACAAC AACAAC AACA AACAA	SWITCHED ↓	TURN ↓	41 41 41 42 42	160 150 150 160 150	16 ↓ ↓ ↓ ↓	
16/29/17 /37 16/31/15 /19 /23	AC__C_AC A____AAC____ACA AACAAC ACAACA A_AACAA	SWITCHED ↓	TURN ↓	42 41 40 40 41	150 ↓ ↓ ↓ ↓	16 ↓ ↓ ↓ ↓	

A-4 TEST DATA: 10/27/72 TAPE VOLUME II (Continued)

TIME (GMT)	REPLY PATTERN	ANT. CONFIG.	MANEUVER	APPROX. p, θ , h			COMMENTS
				p	θ	h (k)	
18/21/22	AC_A__A	BOTTOM	TURN	42	150	16	DROPPING BITS
/26	NONE	↓	↓	43	↓	↓	
/30	C	↓	↓	44	↓	↓	
/34	C__A	↓	↓	44	↓	↓	
/38		↓	↓	43	↓	↓	
18/21/42	A___A__AAC	BOTTOM	TURN	42	150	16	
/46	NONE	↓	↓	42	↓	↓	
/50	NONE	↓	↓	42	↓	↓	
/54	NONE	↓	↓	41	160	↓	
18/22/ 9	ACAACA	↓	↓	39	160	↓	
18/22/25	NONE	BOTTOM	TURN	38	150	15	BEGINNING LEFT
/29	NONE	↓	↓	38	150	15	
18/23/55	NONE	↓	↓	39	160	16	
18/24/34	NONE	↓	↓	35	150	16	
18/25/13	AAC__CAA	↓	↓	38	150	16	
18/25/17	CAAC	BOTTOM	TURN	38	150	16	
/37	A__AAC	↓	↓	37	150	16	
18/26/32	NONE	↓	↓	37	160	16	
18/32/51	NONE	↓	↓	11	60	8	
18/33/11	AACA	↓	↓	12	50	7	
18/36/15	ACAACA	BOTTOM	STRAIGHT, DESCEND	5	0	2	353 & 355 were strong
18/37/14	A___C__AA	↓		3	0	0	
/18	C__ACA	↓		2	0	0	
18/40/28	C__ACAAC	↓	STRAIGHT, ASCEND	15	170	9	
/48	NONE	↓		17	170	9	
18/45/14	NONE	↓		45	140	10	

A-4 TEST DATA: 11/3/72 TAPE VOLUME I

TIME (GMT)	REPLY PATTERN	ANT. CONFIG.	MANEUVER	APPROX. p, θ , h			COMMENTS
				p	θ	h (k)	
16/31/27	A__AACA	SWITCHED	TURN	41	150	16	
/31	A__AA	↓	↓	41	↓	↓	
/54	ACAACA	↓	↓	40	↓	↓	
16/33/38	ACAACA	↓	↓	41	160	↓	
/32	A__A__C__A	↓	↓	41	160	↓	
16/33/36	AACAA	SWITCHED	TURN	41	150	16	
/48	A__AACAA	↓	↓	41	↓	↓	
/52	CAA__AA__A	↓	↓	41	↓	↓	
16/34/ 8	A__AACAA	↓	↓	40	↓	↓	
/12	A__C__C__ACA	↓	↓	40	↓	↓	

A-4 TEST DATA: 11/3/72 TAPE VOLUME I (Continued)

TIME (GMT)	REPLY PATTERN	ANT. CONFIG.	MANEUVER	APPROX. p, θ , h			COMMENTS
				p	θ	h (k)	
16/35/38	ACAA	SWITCHED	TURN	41	160	16	
/46	AA	↓	↓	41	160	↓	
/50	AC__C	↓	↓	42	150	↓	
/54	ACAAC	↓	↓	42	↓	↓	
/58	A_AACAA	↓	↓	42	↓	↓	
16/44/14	AACAAC	SWITCH	STRAIGHT, LEVEL	37	200	16	
16/46/12	AA__AA_8__A	↓	↓	36	220	↓	
/20	A__ACAA__A_A	↓	↓	36	↓	↓	
/24	AC__C__C__CAA_AA	↓	↓	36	↓	↓	
/28	A_C__C__C__5__C_A_AA	↓	↓	36	↓	↓	
16/47/50	NONE	SWITCHED	TURN	36	230	16	
/54	NONE	↓	↓	36	230	↓	
/58	A	↓	↓	35	230	↓	
16/49/24	AAC__C__CA	↓	↓	33	220	↓	
/28	ACAAC	↓	↓	34	220	↓	
16/49/32	A	SWITCHED	TURN	34	220	16	
/36	NONE	↓	↓	34	↓	↓	
/40	AA_AAC	↓	↓	35	↓	↓	

A-4 TEST DATA: 11/3/72 TAPE VOLUME II

TIME (GMT)	REPLY PATTERN	ANT. CONFIG.	MANEUVER	APPROX. p, θ , h			COMMENTS
				p	θ	h (k)	
16/50/39	CAAC_A_A	SWITCHED	TURN	37	220	16	
16/51/7	ACAACA	↓	↓	35	230	↓	
16/52/17	CAACAA	↓	↓	35	220	↓	
/21	A	↓	↓	35	↓	↓	
16/52/57	CA__AC	↓	↓	37	↓	↓	
16/53/16	A__A_A_CA_C	SWITCHED	TURN	37	230	16	
/32	NONE	↓	↓	36	↓	↓	
/36	A_AA	↓	↓	35	↓	↓	
16/54/43	AACAAC	↓	↓	35	220	↓	
/47	NONE	↓	↓	34	220	↓	
16/55/14	A_AA_A	SWITCHED	TURN	37	220	16	
/58	A_AACAA	↓	↓	36	230	↓	
16/56/2	NONE	↓	↓	35	↓	↓	
/5	A_AACAA	↓	↓	35	↓	↓	
/45	A	↓	↓	35	220	↓	

A-4 TEST DATA: 11/3/72 TAPE VOLUME II (Continued)

TIME (GMT)	REPLY PATTERN	ANT. CONFIG.	MANEUVER	APPROX. p, θ , h			COMMENTS
				p	θ	h (k)	
16/56/49	NONE	SWITCHED	TURN	35	220	16	
/52	AC__9__AA	↓	↓	36	↓	↓	
16/57/ 8	A__6__A__CAACAA	↓	↓	36	↓	↓	
/24	NONE	↓	↓	35	↓	↓	
/28	NONE	↓	↓	35	↓	↓	
16/58/47	NONE	SWITCHED	STRAIGHT, LEVEL	29	210	16	
/51	NONE	↓	STRAIGHT, LEVEL	29	210	16	
17/ 0/24	AACAAC	↓	TURN	23	190	14	
17/ 1/ 0	NONE	↓	TURN	21	190	12	
/31	A_AACA	↓	STRAIGHT, DESCEND	18	180	8	
17/ 9/ 1	ACAACA	SWITCHED	TURN	7	30	3	
/25	NONE	↓	↓	7	40	3	
/29	ACAACA	↓	↓	7	50	3	
17/14/30	NONE	↓	↓	13	170	2	
/34	NONE	↓	↓	13	180	2	
17/16/ 4	C__CAAC	SWITCHED	STRAIGHT, DESCEND	10	190	2	
17/22/17	AAC	SWITCHED	STRAIGHT, LEVEL	11	130	9	

C-1 TEST DATA: 10/26/72 TAPE VOLUME I

TIME (GMT)	REPLY PATTERN	ANT. CONFIG.	MANEUVER	APPROX. p, θ , h			COMMENTS
				p	θ	h (k)	
1651/13	C__C__CAA	HARTLOBE	TURN	38	160	10	
/52	AA__C__	HARTLOBE	TURN	40	↓	↓	
56/48	AC__C__C__C__A	BOTTOM	STRAIGHT, LEVEL	39	↓	↓	
57/23	C__C__C__C__ACAAC	BOTTOM	TURN	39	↓	↓	
1700/04	C__A__A__AACA	SWITCHED	STRAIGHT, LEVEL	39	180		
11/03	ACAACA	SWITCHED	STRAIGHT, DESCEND	22	220	10	
/07	NONE	SWITCHED	ING	↓	↓	↓	
/11	A	SWITCHED	TURN	↓	↓	↓	
11/06	A__7__AACA	HARTLOBE	TURN	↓	↓	↓	
/10	ACAAC_A	HARTLOBE	TURN	↓	↓	↓	
15/185	CA	HARTLOBE	TURN	21	220	10	

C-141 TEST DATA: 11/17/72 TAPE VOLUME II

TIME (GMT)	REPLY PATTERN	ANT. CONFIG.	MANEUVER	APPROX. ρ , θ , h			COMMENTS
				ρ	θ	h (k)	
20/ 1/59	A _ 8 _ _ ACA _ 6 _ _ A	SWITCHED	TURN	38	150	16	
20/ 6/42	A _ C _ _ ACA	BOTTOM		38			
/50	NONE	↓	↓	39			
/54	NONE			39			
/57	AACAAC			39			
20/ 7/01		↓	↓	39			
20/ 7/09	NONE	BOTTOM	TURN	39	150	16	
20/15/29	A _ C	↓	LEVEL	34	220		
/33	NONE		LEVEL	34	220		
/37	A _ AAC		LEVEL	34	220		
20/17/03	ACAAC	↓	TURN	39	230		
20/19/44	A _ A _ C _ _ AA	SWITCHED	TURN	39	230	16	
20/19/52	AC _ C _ _ AC	↓		39	230		
20/21/50	A _ _ AC _ AC			36	230		
20/23/51	ACAAC	TOP		34	220		
/55	NONE	TOP	↓	34	220		
20/24/30	NONE	TOP	TURN	33	230	16	
/34	NONE	↓		33	230		
/38	NONE			34	230		
/42	C	↓	↓	35	230		
20/25/06	AACAAC	TOP	TURN	36	230	16	
20/26/59	AACAAC	SWITCHED	LEVEL	33	220		
20/27/03	ACAAC	↓	↓	33	220		
20/28/14	A _ A _ C			27	210		

NOTES: MANY REPLY PULSES FROM OUR AIRCRAFT WERE APPARENTLY OUT OF SPEC (TOO LONG).

C-1 TEST DATA: 10/26/72 TAPE VOLUME II

TIME (GMT)	REPLY PATTERN	ANT. CONFIG.	MANEUVER	APPROX. ρ , θ , h			COMMENTS
				ρ	θ	h (k)	
1736/01	A _ _ CAACA	TOP	TURN	19	220	10	
37/50	NONE	↓	↓				
/54	NONE						
/58	AA _ A						
38/02	AACAA	↓	↓				
39/44	NONE	TOP	TURN	18	220	10	
/48	NONE	↓		19			
41/42	AAC			18			
/46	NONE	↓	↓	19			
47/11	ACA _ C _ AC	SWITCHED		18			

C-1 TEST DATA: 10/26/72 TAPE VOLUME II (Continued)

TIME (GMT)	REPLY PATTERN	ANT. CONFIG.	MANEUVER	APPROX. ρ , θ , h			COMMENTS
				ρ	θ	h (k)	
48/45	ACAA	SWITCHED	TURN	18	210	10	
/49	NONE	↓	↓	18	210	↓	
/53	NONE	↓	↓	18	210	↓	
49/13	.C	↓	↓	19	220	↓	
1800/10	A_AAC_AC	↓	STRAIGHT, LEVEL	7	70	4	
02/03	AAC_CAA	SWITCHED	TURN	11	50	3	
07/16	AC	↓	STRAIGHT, LEVEL	7	10	2	
/20	A__ACA_C_A	↓	↓	6	↓	↓	
/28	CAACA	↓	↓	6	↓	↓	
/32	C__C	↓	↓	6	↓	↓	
1808/27	A_A_C	SWITCHED	STRAIGHT, LEVEL	4	10	2	
18/47	AAC	SWITCHED	TURN	12	60	3	
/51	A_AAC	BOTTOM	TURN	12	60	3	
/55	A_AA	↓	TURN	12	60	3	
24/31	ACAAC	↓	STRAIGHT, LEVEL	11	0	2	
24/43	AACA	BOTTOM	STRAIGHT, LEVEL	11	0	2	
/47	A_AA	↓	↓	↓	↓	↓	
/51	A__8__ACAA	↓	↓	↓	↓	↓	

C-1 TEST DATA: 10/26/72 TAPE VOLUME III

TIME (GMT)	REPLY PATTERN	ANT. CONFIG.	MANEUVER	APPROX. ρ, θ, h			COMMENTS
				ρ	θ	h (k)	
1912/15	CA_C__CA_C	BOTTOM	TURN	40	150	10	
/19	CA	↓	↓	40	↓	↓	
14/00	AACA_C_A			40			
15/23	A__A__A			39			
/27	AACA__AA	↓	↓	40	↓	↓	
15/31	A__A	BOTTOM	TURN	40	150	10	
16/57	C__A_AA	?		40	↓	↓	
21/20	ACA_A__A_A	SWITCHED	↓	41			
26/45	NONE	TOP		41	↓	↓	
/57	A	TOP	↓	41	↓	↓	

APPENDIX B

EFFECT OF MODE INTERLACE ON EN ROUTE TARGET DETECTION PROBABILITY

The effect of a different interlace pattern on the probability for detection of an aircraft with switching antennas was indicated in Section 1.C.2. Data gathered on the F-105 and A-4, utilizing sites tied into the Washington ARTCC, appear to lend substance to the comparative performances predicted for the two interlace patterns. As this information was collected in a more loosely controlled fashion one must exercise caution in forming conclusions based exclusively on it. Although the data are not unassailable, they appear to be consistent, for maneuvers that were repeated and for the same maneuvers at different locations. Those target data gathered at NAFEC are backed up by analog and wide-band recordings.

F-105 Results

Two aircraft test flights will be discussed. One, part of the En Route tests, was carried out between Norfolk (ORF) and Salisbury (SBY), the other, part of the Terminal Area tests, between Patuxent (PXT), Cambridge (CGE), and Brooke (BRV). Data for the first were gathered at Elwood, for the second at Bedford and Cape Charles. Elwood employed 3/A, 3/A, C; the other two, 3/A, 2, 3/A, C: all used $T_L=6$. The first aircraft executed two 360° turns with both antennas (cycled through the lobing switch), two more with the bottom antenna selected, and finally two with the top antenna, at ORF. Single turns with the top, bottom, and both were then repeated at SBY. Altitudes employed were 28,000 feet at ORF and 25,000 feet at SBY. Track plots show turning rates averaging at $1.2^\circ/\text{sec}$, suggesting a bank angle between 25° and 30° .

Data for the second test flight were gathered while the aircraft was orbiting at 16,000 ft with the same approximate radius of turn. This aircraft performed two turns at PXT with both antennas, two at CGE with the bottom and then was flown to BRV for two with the bottom, two with both, two with the top, and finally one with both. In accordance with the flight plans, the pilots followed a specified order in selecting antennas and also confirmed each change by radio to Washington center. The disparity in performance of the different antennas generally showed clearly in the data.

In the En Route tests at NAFEC the aircraft was actually executing orbits at ORF before a discrete code was employed; however, for the second turn with both antennas, there was but one miss in 30 scans. In the succeeding two orbits with the bottom antenna selected, there were 37 misses out of 70 scans giving an overall P_D of 0.47 but of greater significance is the fact that an unbroken 15-miss sequence occurred at exactly the same portion of each orbit. This portion was where the aircraft was on the far side of the turn and is precisely where shadowing of the bottom antenna is predicted. In the two and a half turns with the top antenna, 6 targets out of 73 were lost; all when the aircraft was on an outbound radial course. As the top antenna is forward of the canopy, one would predict a small gap in coverage in the rearward direction.

The closer range to SBY, 80 nm versus 175 to ORF, increases the overall probability for detection in turns but the pattern remains approximately the same. In the first one and a half turns, with the top antenna, 2 targets out of 35 were lost; with the bottom antenna, a single 5-miss sequence of misses occurred in the one turn; finally, with both antennas no targets were lost.

Summarizing the En Route data from Elwood produces the following:

F-105, ELWOOD (FAA)

	Bottom			Both			Top		
	Scans	Misses	P_D	Scans	Misses	P_D	Scans	Misses	P_D
ORF	70	37	0.47	117	10	0.93	76	6	0.92
SBY	30	5	0.83	33	0	1.00	35	2	0.94

The ranges from Bedford to PXT, CGE, and BRV, are 155, 170, and 115 nm, respectively; whereas from Cape Charles they are between 65 and 90 nm. Coverage at CGE from Bedford is somewhat surprising for an altitude of 16,000 ft, and less weight should be given to data gathered there and at PXT than to that gathered at BRV.

The Bedford data can all be summarized as follows:

F-105, BEDFORD (USAF/FAA)

	Bottom			Both			Top		
	Scans	Misses	P_D	Scans	Misses	P_D	Scans	Misses	P_D
PXT	-	-	-	39	29	0.26	-	-	-
CGE	39	18	0.54	-	-	-	-	-	-
BRV	50	31	0.38	64	36	0.44	45	14	0.69

Data of possibly greater reliability gathered at Cape Charles are summarized below:

F-105, CAPE CHARLES (USAF/FAA)

	Bottom			Both			Top		
	Scans	Misses	P_D	Scans	Misses	P_D	Scans	Misses	P_D
PXT	-	-	-	39	10	0.74	-	-	-
CGE	58	34	0.41	-	-	-	-	-	-
BRV	50	23	0.54	64	15	0.77	45	6	0.87

With both antennas switching, the values of P_D for a 3/A, 3/A, C interlace are clearly higher than those for the 3/A, 2, 3/A, C interlace. It can also be seen that the lowest values of P_D are consistently produced by the bottom antenna; the highest, by the top. In contrast to the Elwood results, those tabulated above, especially for Cape Charles, suggest that with both antennas cycling one recovers only a fraction of targets lost by shadowing of the bottom antenna. This, of course, is what would be expected for a 3/A, 2, 3/A, C interlace.

Bearing in mind the significance of consecutive misses, one may compare the 10 misses obtained in each of two turns with the bottom antenna at BRV with the 4 misses in each obtained with both antennas, as seen from Cape Charles. A similar ratio applies for the same comparison at PXT and CGE.

Although it is clear, therefore, that the lobing switch is better than the bottom antenna for the F-105, how much better depends on the interlace pattern employed at the En Route site.

A-4 Data

Data gathered in test flights of the A-4 give additional insight to the comparative performances of transponder antennas versus the two interlace patterns. However, for this aircraft the lobing frequency was 20, rather than 38 Hz; consequently, the dwell time was 25 msec, permitting 9 replies in a group. For the 3/A, 3/A, C interlace, a full group always contains 6 mode 3/A replies and there are two such groups per scan; hence the sliding window has two chances to declare T_L but never contains more than 6 replies. For the 3/A, 2, 3/A, C interlace there are two possibilities depending on whether or not the illuminated antenna is first interrogated in mode 3/A. If it is then there are 5 such replies per group and the sliding window could contain a maximum of 7. If it is not, there are 4 replies per group and the sliding window never contains more than 6. On balance

therefore, the 3/A, 2, 3/A, C interlace provides a higher probability for detection than the 3/A, 3/A, C for this aircraft. Video data recorded at Elwood show that the make-before-break feature of the CS-432A lobing switch actually extends the groups at times to 10 or 11 replies so round reliability does not have to be quite as high as predicted theoretically.

The low frequency switch would be expected to exacerbate the problem of azimuth jitter because the two reply groups per scan are centered 0.9° apart; thus, T_L could move that far by loss of a single mode 3/A hit.

As the A-4 used in these tests lacked a cockpit selector, four flights were made; two for the Elwood PCD, two for ARTS III. For each location one flight exercised the bottom antenna and a second both antennas cycling. Orbits in the first were at ORF and SBY, in the second at PXT and BRV. Rate of turn was approximately $3.3^\circ/\text{sec}$, implying a bank angle of 60° .

In straight and level flight, the probability for detection with either antenna option was high, $\geq 94\%$, so attention here will be limited to discussing data gathered in 360° turns. That collected at Elwood is summarized below:

A-4, ELWOOD (FAA)

	Bottom			Both		
	Scans	Misses	P_D	Scans	Misses	P_D
ORF	41	19	0.54	45	12	0.73
SBY	42	5	0.88	34	5	0.85
SIE	18	1	0.96	33	2	0.94

The comparatively better performance of both antennas at ORF was not sustained at SBY and SIE where the bottom antenna performed just as well. This apparent inconsistency is supported by wide-band recordings and by decoded hit counts.

For data collected during the tests in the Washington area at Suitland, Cape Charles, and Bedford, we have only the recorded output of the PCD's. Suitland employed 3/A, 3/A, C, as it is an FAA site, but is at a relatively close range to provide typical En Route data. Bedford, on the other hand, is 160 nmi from PXT, which puts the horizon at ~16,000 ft (4/3 earth radius) and one might expect poor results under those conditions. The pertinent data are summarized below:

A-4

	Bottom			Both		
	Scans	Misses	P_D	Scans	Misses	P_D
PXT (Suitland)	72	12	0.84	-	-	-
PXT (Cape Charles)	-	-	-	47	11	0.77
PXT (Bedford)	59	20	0.66	47	4	0.92
BRV (Suitland)	42	6	0.86	-	-	-
BRV (Cape Charles)	-	-	-	54	8	0.85
BRV (Bedford)	34	9	0.74	54	3	0.95

Unsurprisingly, Bedford provides a lower P_D than Suitland and the plotted tracks show that essentially all of the misses with the bottom antenna occurred as expected, when the aircraft was on the far side of the turn. Comparing antennas, Bedford data show a moderately strong advantage for both

antennas switching over the bottom antenna alone. The plots also show a fairly high frequency ($> 10\%$) of azimuth jitter in both turns and straight and level flight with a crudely estimated probable error of 0.4° , when both antennas are employed.

As the values for P_D obtained at Cape Charles are inexplicably lower than those for Bedford, it is doubtful if too much should be deduced from them. Therefore, if one may compare the effects of the two different interlace patterns on P_D with switching antennas by utilizing data for ORF collected at Elwood and for PXT collected at Bedford, it does appear that 3/A, 2, 3/A, C, gives better results for the A-4 with the mechanical lobing switch, as predicted.