

**Project Report**  
**ATC-299**

**The Radar Correlation and Interpolation (C&I)  
Algorithms Deployed in the ASR-9 Processor  
Augmentation Card (9PAC)**

G.R. Elkin

29 June 2001

---

**Lincoln Laboratory**

MASSACHUSETTS INSTITUTE OF TECHNOLOGY  
*LEXINGTON, MASSACHUSETTS*



---

Prepared for the Federal Aviation Administration,

Washington, D.C. 20591

This document is available to the public through  
the National Technical Information Service,  
Springfield, Virginia 22161.

This document is disseminated under the sponsorship of the Department of Transportation in the interest of information exchange. The United States Government assumes no liability for its contents or use thereof.

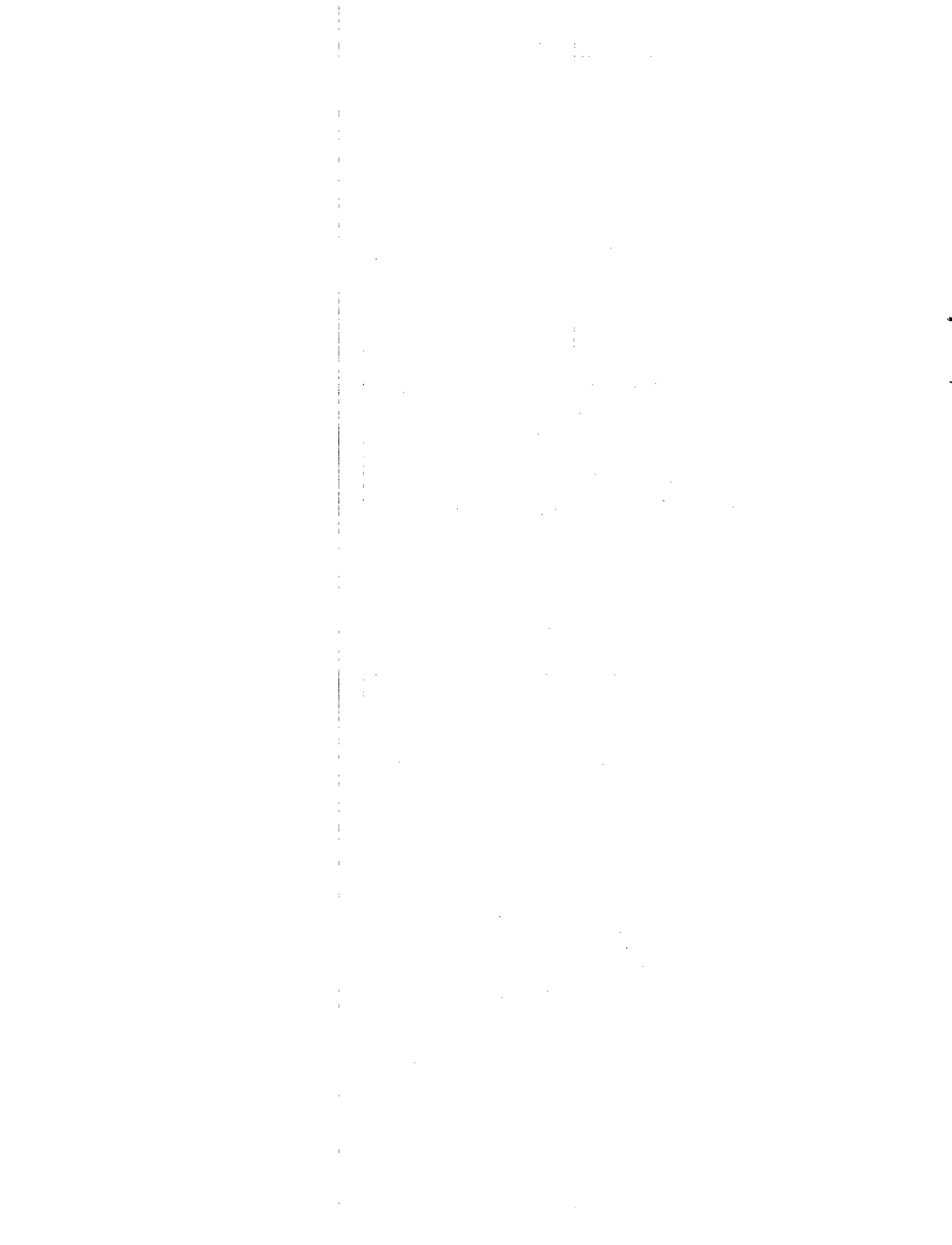

1. Report No. ATC-299	2. Government Accession No.	3. Recipient's Catalog No.	
4. Title and Subtitle The Radar Correlation and Interpolation (C&I) Algorithms Deployed in the ASR-9 Processor Augmentation Card (9PAC)		5. Report Date 29 June 2001	6. Performing Organization Code
7. Author(s) G.R. Elkin		8. Performing Organization Report No.	
9. Performing Organization Name and Address Lincoln Laboratory, MIT 244 Wood Street Lexington, MA 02420-9108		10. Work Unit No. (TRAIS)	11. Contract or Grant No.
12. Sponsoring Agency Name and Address Department of Transportation Federal Aviation Administration Systems Research and Development Service Washington, DC 20591		13. Type of Report and Period Covered Project Report	14. Sponsoring Agency Code
15. Supplementary Notes  This report is based on studies performed at Lincoln Laboratory, a center for research operated by Massachusetts Institute of Technology, under Air Force Contract F19628-00-C-0002.			
16. Abstract  The Airport Surveillance Radar 9 (ASR-9) is a terminal radar that was deployed by the FAA during the early 1990's at more than 130 of the busiest airports in the United States. The ASR-9 Processor Augmentation Card (9PAC), developed at MIT Lincoln Laboratory, is a processor board enhancement for the ASR-9 post-processor. The increased processing speed and memory size of the 9PAC hardware made it possible for new surveillance algorithms to be developed in software in order to provide improved primary radar and beacon surveillance performance. This report describes improvements to the primary radar correlation and interpolation (C&I) process, which is responsible for creating aircraft target reports and filtering out false targets. The 9PAC C&I provides the following improvements: (1) it automates the creation and modification of the road and ground clutter geocensoring process, which had been a time-consuming human-in-the-loop process; (2) it improves the rejection of false targets using multi-layered false target filtering maps; and (3) it improves the detection of general aviation and military aircraft that are not equipped with beacon transponders or have them turned off. The algorithms described in this report have been implemented as part of 9PAC Phase II, which is currently being tested by the FAA at Dallas-Fort Worth, Salt Lake City, Honolulu, Las Vegas, Oakland, Palm Springs, and Sarasota airports. The 9PAC primary radar algorithms function in coordination with beacon processing algorithms which are resident in either the 9PAC for the interim beacon interrogator (IBI) mode of operation or the Mode S sensor for monopulse operation. In the former, the 9PAC performs the functions of radar beacon reinforcement whereas in the latter, the Mode S sensor provides the function.			
17. Key Words		18. Distribution Statement  This document is available to the public through the National Technical Information Service, Springfield, VA 22161.	
19. Security Classif. (of this report)  Unclassified	20. Security Classif. (of this page)  Unclassified	21. No. of Pages  197	22. Price



## EXECUTIVE SUMMARY

The Airport Surveillance Radar 9 (ASR-9) is a terminal radar that was deployed by the Federal Aviation Administration (FAA) during the early 1990's at more than 130 of the busiest airports in the United States. The ASR-9 Processor Augmentation Card (9PAC), developed at MIT Lincoln Laboratory, is a processor board enhancement for the ASR-9 Array Signal Processor (ASP) which provides increases in processing speed, memory size, and programming ease. The increased capabilities of the 9PAC hardware made it possible for new surveillance algorithms to be developed in software to provide improved primary radar and beacon surveillance performance.

This report is part of a series of reports describing the 9PAC and its algorithms. This report describes the improvements to the primary radar Correlation and Interpolation (C&I) process, which is responsible for creating aircraft target reports and filtering out false targets. The 9PAC C&I was developed in order to accomplish the following goals:

- automation of the road and ground clutter censoring process, which had been a time-consuming human-in-the-loop process that required initial set up time at each site and periodic revisiting to address environmental changes;
- improving the rejection of false targets; and
- improving the detection of general aviation aircraft that are not equipped with beacon transponders.

To accomplish these goals, the 9PAC C&I employs a multi-layered false target filtering map system. The geocensor map layer provides a completely automated ground clutter censoring system with increased resolution and the ability to react to changing environmental conditions. The other adaptive map layers are aimed at discriminating between aircraft and non-aircraft targets (i.e., resulting from bird flocks and weather).

The 9PAC project was developed in two phases. Phase I, which addressed a beacon false target problem, was completed, and is currently being deployed nationwide by the FAA. The FAA is currently testing Phase II, which addresses the primary radar surveillance problems, at the following airports: Dallas-Fort Worth, Salt Lake City, and Honolulu. Thus far, 9PAC Phase II has been well received by Air Traffic Controllers at the airport test sites.

The 9PAC primary radar algorithms function in coordination with beacon processing algorithms that are resident in either the 9PAC for the interim beacon interrogator (IBI) mode of operation [8] or the Mode S sensor for monopulse operation (also known as Monopulse Secondary Surveillance Radar, or MSSR mode). In the former, the 9PAC performs the beacon target detection and radar beacon reinforcement, whereas in the latter, the Mode S sensor performs these functions. The timing of the disseminated data relative to the antenna position is different in the two modes of operation. In the IBI mode, all data is contained within the 9PAC and dissemination has less latency. In the MSSR mode, dissemination is slightly slower because of the need to exchange data between the Mode S and 9PAC processors and because of timing constraints imposed by close in targets on the MSSR discrete interrogation operation.



## ACKNOWLEDGMENTS

The author wishes to acknowledge the contributions of the many people whose efforts have made the 9PAC Phase II program a success. Ed Hall, Jim Pieronek, and Greg Rocco designed and built the 9PAC prototype boards and associated hardware. Professor John Anderson of the University of Wisconsin, Oliver Newell, and Jenifer Evans developed the algorithms and software of the original Phase II prototype which served as the starting point of these efforts. The current edition of the Phase II C&I algorithm retains much of the original code developed by John and Oliver, and this report is based on their report ATC-236: Description of Radar Correlation and Interpolation Algorithms for the ASR-9 Processor Augmentation Card (9PAC). Walter Heath developed the 9PAC flash card file system, and also contributed significantly to the 9PAC adapter/simulator software. Claranne Bechtler assisted in the development of data extraction and data reduction software, and also graciously took on the challenge of becoming the resident expert on the 9PAC C&I radar target centroiding algorithms. Jeffrey Gertz and Robert Grappel developed radar tracking algorithms; Bob wrote the tracker code.

The 9PAC program was a collaborative effort by Lincoln Laboratory and the FAA. During the past six years, William Goodchild (AND-420) put his heart and soul into the 9PAC program. Bill and I have worked together on 9PAC (Phases I and II) on a daily basis, and I have never met a person more dedicated to quality. Bill was my partner in developing and torture testing the adaptive thresholding and geocensoring algorithms described in this report. In addition, Bill was instrumental in guiding the initial and operational testing. Bill taught me the difference between developing a prototype and fielding an operational-quality system. I am also indebted to the FAA ASR-9 support team (AOS-270) at Atlantic City, New Jersey. Ed Paule and Mark Edwards developed the software modifications necessary for the ASR-9 to interface with the 9PAC software. Mark reviewed this report and pointed out several omissions. Steve Dowden worked with Bill Goodchild and myself in the field site testing effort for 9PAC Phase II.

Karen Anderson, Brian Adams, and John Messini aided the testing effort at the ASR-9 site at Lincoln Laboratory. Wesley Johnston and Jeff Chavez aided the Albuquerque field site testing effort.



# TABLE OF CONTENTS

Executive Summary.....	iii
Acknowledgments.....	v
List of Illustrations .....	ix
List of Tables .....	xiii
<b>1. Introduction .....</b>	<b>1</b>
<b>2. ASR-9 Background .....</b>	<b>3</b>
2.1 ASR-9 Front-End Radar Processing .....	4
2.2 9PAC Post-Processor Upgrade.....	8
2.2.1 Post-Processor Hardware Upgrade.....	8
2.2.2 Post-Processor Software Upgrade .....	10
2.3 Operation with the Mode S Sensor.....	12
<b>3. C&amp;I Requirements.....</b>	<b>15</b>
<b>4. 9PAC C&amp;I Algorithm Description.....</b>	<b>17</b>
4.1 Initialization/Reset.....	18
4.2 Input Parsing.....	18
4.3 Saturation And ZVF Overflow Processing.....	19
4.4 Correlation Of Radar Primitives .....	19
4.4.1 Target Initiation .....	19
4.4.2 Target Updating.....	20
4.4.3 Active Target Termination .....	21
4.5 RFI Processing .....	22
4.6 Interpolation.....	22
4.6.1 Range Interpolation.....	22
4.6.2 Azimuth Interpolation.....	23
4.6.3 Doppler Interpolation And Smoothing .....	28
4.7 Target Reformatting.....	32
4.8 Delay Processing.....	32
<b>5. Geocensoring And Adaptive Thresholding.....</b>	<b>35</b>
5.1 Overview .....	35
5.2 Geocensoring .....	36
5.2.1 Geo Cell Identification And Management.....	37
5.2.2 Threshold Determination.....	45
5.2.3 Target Censoring .....	46
5.3 Multi-Grid Adaptive Thresholding .....	48
5.3.1 Adaptive Map Dimensions.....	49
5.3.2 Adaptive Map Threshold Comparison And Increment.....	51
5.3.3 Adaptive Map Threshold Decrement.....	59
5.3.4 Bird Map Activation And Deactivation .....	64
5.3.5 Adaptive Map Threshold Correction .....	70
<b>6. Two-Level Weather.....</b>	<b>75</b>
6.1 Temporal Smoothing.....	75
6.2 Contouring.....	75
<b>7. Project Status.....</b>	<b>77</b>

<b>Appendix A. Variable Site Parameters (VSP)</b> .....	<b>79</b>
<b>Appendix B. Performance Monitoring/Alarms</b> .....	<b>101</b>
<b>Appendix C. C&amp;I State And Data Flow Diagrams</b> .....	<b>111</b>
<b>Appendix D. Input/Output Formats</b> .....	<b>163</b>
<b>Appendix E. C&amp;I Constants</b> .....	<b>177</b>
<b>GLOSSARY</b> .....	<b>179</b>
<b>REFERENCES</b> .....	<b>181</b>

## LIST OF ILLUSTRATIONS

Figure No.	Page
Figure 2-1. Block diagram of one channel of the ASR-9. ....	3
Figure 2-2. ASR-9 range/azimuth/PRF layout. ....	4
Figure 2-3. ASR-9 front-end signal processing.....	5
Figure 2-4. ASR-9 STC attenuation vs. range (typical). ....	5
Figure 2-5. Doppler filter bank (high PRF). ....	6
Figure 2-6. Evolution of the ASR-9 post-processing configuration.....	9
Figure 2-7. 9PAC block diagram.....	10
Figure 2-8. Data flow for the ASP-based post-processing algorithms. ....	11
Figure 2-9. Data flow for the 9PAC Phase II post-processing algorithms ....	12
Figure 4-1. C&I processing block diagram.....	17
Figure 4-2. Detection of multiple targets in a primitive range group.....	20
Figure 4-3. Antenna azimuth beam pattern (low beam). ....	25
Figure 4-4. Azimuth correction vs. CPI amplitude difference.....	26
Figure 5-1. Multiple thresholding stages. ....	36
Figure 5-2. Geocensor cell data structure. ....	38
Figure 5-3. Geo report counting implementation. ....	41
Figure 5-4. Geocensor cell state transition diagram. ....	42
Figure 5-5. 9PAC adaptive map thresholding stages.....	49
Figure 5-6. Adaptive map threshold comparison block diagram. ....	52
Figure 5-7. Exclusion from adaptive map processing. ....	54
Figure 5-8. Fine/Medium/Coarse adaptive map comparison logic for multiple-CPI reports. ....	56
Figure 5-9. Fine/Medium/Coarse adaptive map comparison logic for single-CPI reports.....	57
Figure 5-10. Bird adaptive map comparison logic. ....	58
Figure 5-11. Bird map state transition diagram.....	66
Figure 5-12. Tracker heading map bins used to detect migratory birds. ....	69
Figure 5-13. Tracker 45-degree heading map tri-sectors.....	69

<b>Figure No.</b>	<b>Page</b>
Figure 5-14. C&I adaptive map feedback block diagram.....	70
Figure C-1. C&I processing top level block diagram.....	111
Figure C-2. Input parsing state transition diagram.....	112
Figure C-3. ZVF overload processing.....	113
Figure C-4. Saturation preprocessing.....	114
Figure C-5. Target correlation.....	115
Figure C-6. Association and range resolution processing.....	116
Figure C-7. Primary RFI processing.....	117
Figure C-8. Azimuth centroiding.....	118
Figure C-9. Doppler interpolation.....	119
Figure C-10. Doppler smoothing.....	120
Figure C-11. Geocensor and adaptive map processing.....	121
Figure C-12. Geocensor map thresholding.....	122
Figure C-13. Single CPI geocensor map thresholding.....	123
Figure C-14. Multiple CPI geocensor map thresholding.....	124
Figure C-15. Adaptive map thresholding.....	125
Figure C-16. Fine adaptive map thresholding.....	126
Figure C-17. Medium adaptive map thresholding.....	127
Figure C-18. Coarse adaptive map thresholding.....	128
Figure C-19. Bird adaptive map thresholding.....	129
Figure C-20. Geocensor map report counting for deleted reports.....	130
Figure C-21. Incrementing the geocensor map cell counts.....	131
Figure C-22. Geocensor map update at the end of a 512-scan block.....	132
Figure C-23. Geocensor map cells update for given range and azimuth.....	133
Figure C-24. Permanent geocensor cell update.....	134
Figure C-25. Elephant geocensor cell update.....	135
Figure C-26. Normal geocensor cell update.....	136
Figure C-27. Adaptive map update.....	137

<b>Figure No.</b>	<b>Page</b>
Figure C-28. Fine adaptive map update.....	138
Figure C-29. Medium adaptive map update.....	139
Figure C-30. Coarse adaptive map update.....	140
Figure C-31. Bird adaptive map update.....	141
Figure C-32. Threshold decrement for coarse and bird adaptive map cells. ....	142
Figure C-33. Supplemental RFI processing.....	143
Figure C-34. Geocensor and adaptive map feedback processing.....	144
Figure C-35. Adaptive map correction for radar-beacon reports output by the Merge.....	145
Figure C-36. Adaptive map correction for correlated radar reports output by the Tracker.....	146
Figure C-37. Single CPI adaptive map correction for correlated radar reports. ....	147
Figure C-38. Multiple CPI adaptive map correction for correlated radar reports.....	148
Figure C-39. Adaptive map correction for slow-moving tracks. ....	149
Figure C-40. Adaptive map report counting for uncorrelated radar reports.....	150
Figure C-41. Geocensor map report counting for correlated radar reports.....	151
Figure C-42. Geocensor map report counting for uncorrelated radar reports.....	152
Figure C-43. North mark processing. ....	153
Figure C-44. Bird adaptive map state determination.....	154
Figure C-45. Bird adaptive map state 0 processing.....	155
Figure C-46. Bird adaptive map state 1 processing.....	156
Figure C-47. Bird adaptive map state 2 processing.....	157
Figure C-48. Bird adaptive map state 3 processing.....	158
Figure C-49. Bird adaptive map state 4 processing.....	159
Figure C-50. Bird adaptive map state 5 processing.....	160
Figure C-51. Single CPI coarse map single scan decrement determination.....	161
Figure D-1. CPIP input data layout.....	163



## LIST OF TABLES

<b>Table No.</b>	<b>Page</b>
Table 2-1. ASR-9 System Parameters .....	3
Table 4-1. Range Reduction Step Sizes .....	33
Table 5-1. Active Report Count VSPs.....	42
Table 5-2. Normal Geo Cell Minimum Report Count VSPs .....	43
Table 5-3. Elephant Geo Cell Block VSPs .....	44
Table 5-4. Elephant Geo Cell Deactivation VSPs.....	44
Table 5-5. Elephant Geo Cell Activation VSPs .....	44
Table 5-6. Permanent Geo Cell Block Percentage VSPs.....	45
Table 5-7. Fixed Geo Cell VSP Region.....	45
Table 5-8. Geocensor Map Threshold Comparison.....	47
Table 5-9. Geocensor Deletion Threshold Offset VSPs .....	48
Table 5-10. Geocensor Deletion Report Count VSPs .....	48
Table 5-11. Adaptive Map Cell Sizes.....	50
Table 5-12. Single-CPI Report Doppler Filter to Radial Velocity Conversion .....	53
Table 5-13. Adaptive Map Amplitude Exclusion VSP.....	55
Table 5-14. Fine and Medium Adaptive Map Threshold Decrement VSPs .....	60
Table 5-15. Bird Map State Summary .....	66
Table 5-16. Bird Map State Transition Rules .....	67
Table 5-17. Threshold Feedback Based for Multiple-CPI Correlated Radar Reports.....	72
Table 5-18. Threshold Feedback Based for Single-CPI Correlated Radar Reports .....	73
Table B-1. HSIB Input Performance Counts .....	101
Table B-2. General C&I Performance Counts .....	102
Table B-3. Adaptive Thresholding Performance Counts (continued) .....	103
Table B-3. Adaptive Thresholding Performance Counts (concluded) .....	104
Table B-4. General Geocensoring Performance Counts.....	105
Table B-5. Multiple CPI Geocensoring Performance Counts (continued) .....	106

<b>Table No.</b>	<b>Page</b>
Table B-5. Multiple CPI Geocensoring Performance Counts (concluded) .....	107
Table B-6. Single CPI Geocensoring Performance Counts (continued) .....	108
Table B-6. Single CPI Geocensoring Performance Counts (concluded).....	109
Table B-7. Performance Alarms.....	110
Table D-1. Centroid Algorithm IDs.....	176
Table E-1. High PRF Doppler Interpolation Constants.....	177
Table E-2. Low PRF Doppler Interpolation Constants.....	177
Table E-3. ASR-9 Low/High Beam Patterns .....	178



# 1. INTRODUCTION

The Airport Surveillance Radar 9 (ASR-9) is a terminal radar that was deployed by the Federal Aviation Administration (FAA) during the early 1990's at more than 130 of the busiest airports in the United States. The ASR-9 Processor Augmentation Card (9PAC), developed at MIT Lincoln Laboratory, is a processor board enhancement for the ASR-9 Array Signal Processor (ASP) that provides increases in processing speed, memory size, and programming. The increased capabilities of the 9PAC hardware made it possible for new surveillance algorithms to be developed in software to provide improved primary radar and beacon surveillance performance [1].

The 9PAC project was developed in two phases. Phase I, which addressed the beacon reflection false target problem, was completed, and is currently being deployed nationwide by the FAA on a plug and play basis. Phase II addresses the primary radar surveillance problems, which include automation of the road and ground clutter censoring process, improving the rejection of false targets, and improving the detection and tracking of aircraft targets. The 9PAC also reduces the life-cycle maintenance cost of the ASR-9 in the Phase II configuration, in which a single 9PAC card replaces four ASP cards. This report describes the improvements to the radar Correlation and Interpolation (C&I) process, which is responsible for creating aircraft target reports and filtering out false targets.

Unlike the 9PAC beacon algorithms [2, 8], which are fundamentally different from the original ASP version in many respects, a substantial fraction of the C&I algorithms remains essentially intact. The exceptions to this are the areas of geocensoring and adaptive thresholding, which have been redesigned completely in 9PAC. Another major 9PAC enhancement consisted of porting the ASP assembly language software to a high-level programming language (C). Using the increased processor speed and memory capacity of the 9PAC hardware, the 9PAC C&I software maintains more sophisticated geocensoring and adaptive thresholding 'maps', allowing for more intelligent rejection of false targets (e.g., roads, weather, birds) and a corresponding gain in system performance to aircraft targets. The 9PAC adaptive geocensor map automates the previously labor-intensive road and ground clutter suppression process, resulting in a reduction in site optimization and maintenance costs.

Sections 2 and 3 of this document provide background information on the ASR-9, 9PAC, and C&I requirements. Section 4 describes the subset of C&I algorithms that were ported to the C language with only minor enhancements. Section 5 describes the new geocensoring and adaptive thresholding algorithms. Section 6 supplies details of the two-level weather processing algorithms, which are not part of the C&I processing per se, but are grouped with C&I because the weather data is embedded in the radar data stream. Section 7 summarizes the work done to date. Lastly, appendices contain lists of Variable Site Parameters (VSPs) and Performance Monitoring/Alarm outputs, algorithm flowcharts, report formats, and constant tables.

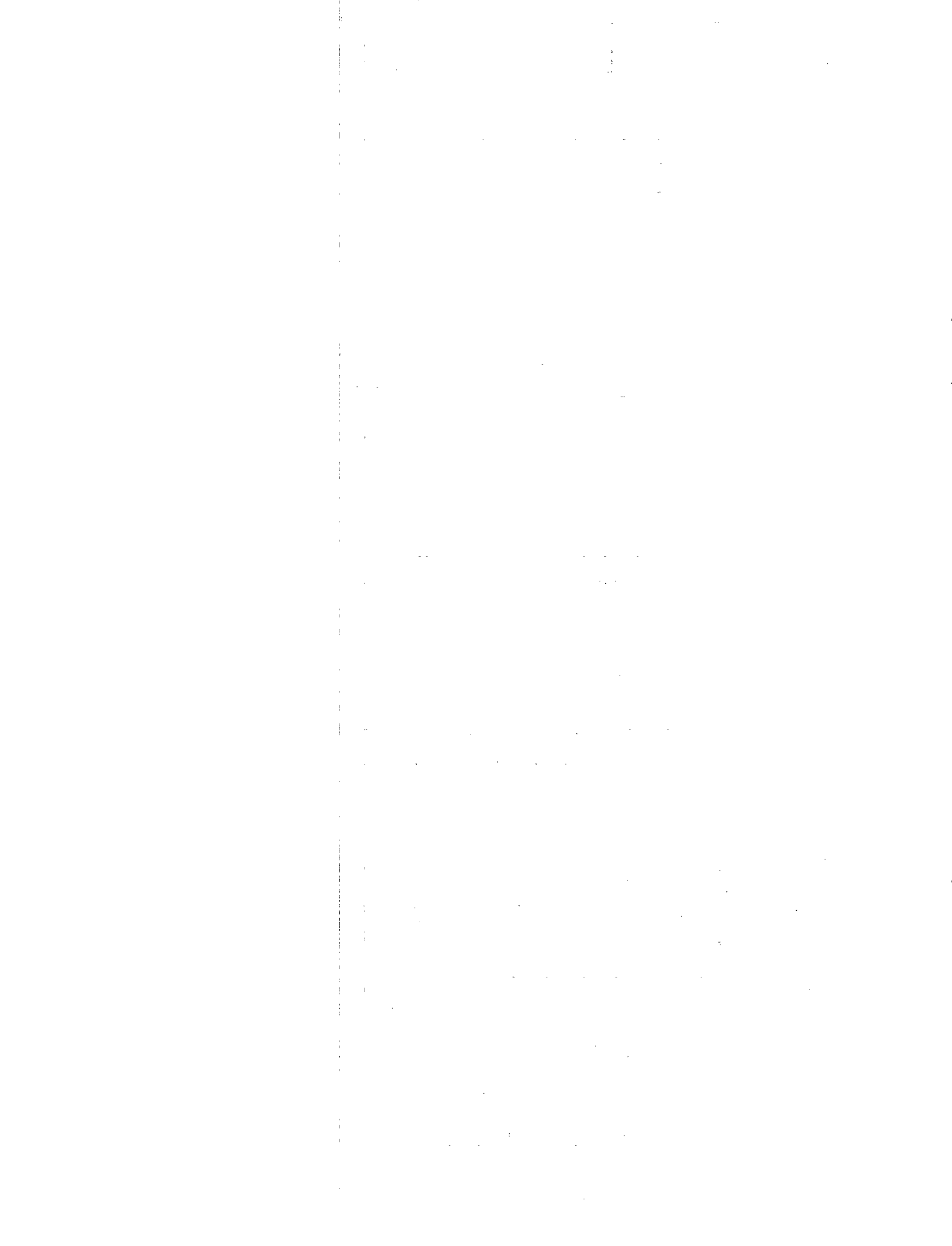

## 2. ASR-9 BACKGROUND

This section provides background on ASR-9 radar processing and the 9PAC architecture, which will make the 9PAC C&I algorithm description easier to understand. Figure 2-1 shows the components of a single ASR-9 channel [1]. The primary radar processing components can be categorized as belonging either to the "front end" or "back end" of the radar. The front end consists of the antenna, transmitter, receiver, and digital signal processing (DSP) blocks in the figure. The output of the front end is primitive detections that require further data processing in order to generate aircraft target reports. The back end is the post-processor and communications system, where the data processing and transmission to air traffic automation systems occurs. The 9PAC is an upgrade to the ASR-9 post-processor hardware and software.

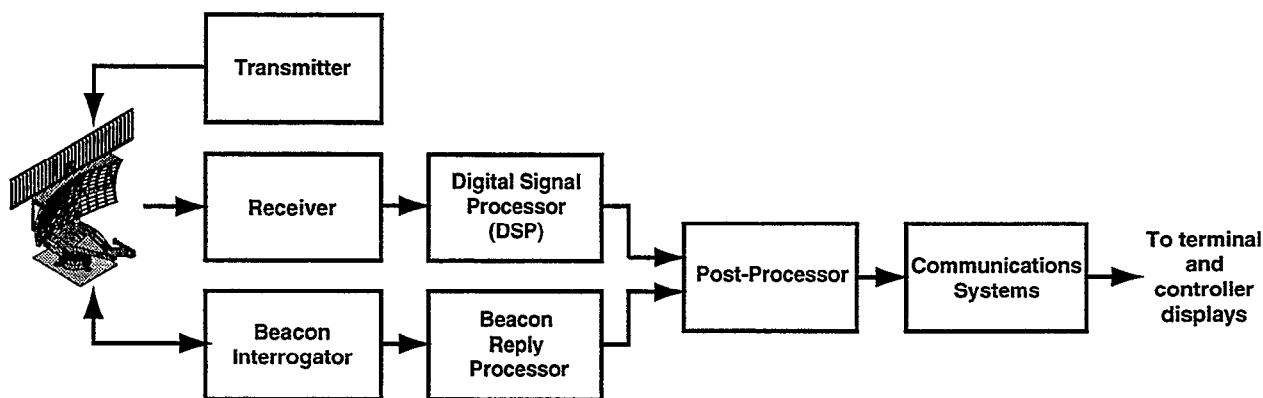

Figure 2-1. Block diagram of one channel of the ASR-9.

Table 2-1. ASR-9 System Parameters

Antenna	Cosecant <sup>2</sup> Fan Beam. Single transmit beam, Dual receive beams (1 passive)
Rotation Rate	12.5 RPM +/- 10%
Frequency	2.7-2.9 GHz
Transmit Power	1.12 MW (Peak)
Pulse Width	1.03 ms
Azimuth Beamwidth	1.4 deg.
Elevation Beamwidth	4.8 deg. (min)
PRF	Block Staggered. Average PRF between 1059-1172
A/D Converters	12-bit
Range Gate Size	1/16th nmi
System Range	60 nmi

Table 2-1 lists for the ASR-9 the typical system parameters used to describe a radar system. The ASR-9 transmits pulses at two different pulse repetition frequencies (PRFs), alternating between the two PRFs. This approach, referred to as "block staggering," is used to help eliminate blind speeds to unmask targets obscured by weather clutter on one PRF, but not on the other. A blind

speed is a radial velocity that cannot be detected by a given PRF. A target whose radial dependent Doppler shift is equal to or is a multiple of one of the radar's PRFs will not be detected; it will only show up in the other PRF. The ASR-9 transmits ten pulses at the high PRF, followed by eight pulses at the low PRF. Additional 'fill' pulses (usually one or two, but dependent on PRF and antenna wind loading) are transmitted at the low PRF until the antenna reaches the next 1.4 degree sector, when the sequence is repeated. Each series of ten or eight pulses is called a 'Coherent Processing Interval' (CPI), with the pair referred to as a 'CPI Pair.' An entire antenna scan contains 256 1.4 degree CPI Pairs. Range cells in each CPI are spaced at 1/16<sup>th</sup> nmi intervals, with a total of 960 gates providing the full 60 nmi coverage. This range, azimuth layout is depicted in Figure 2-2.

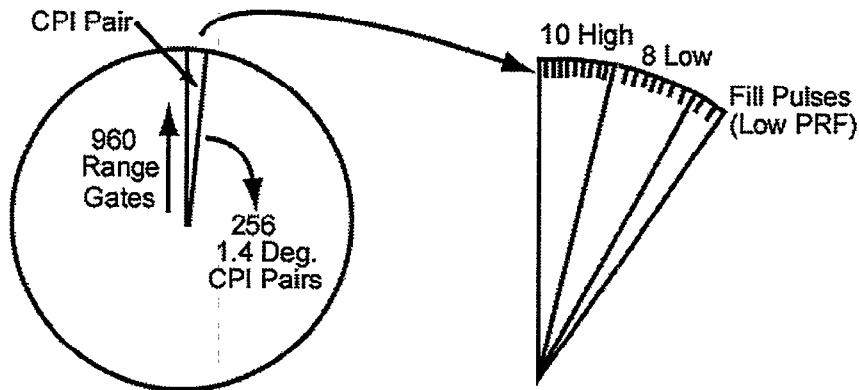

Figure 2-2. ASR-9 range/azimuth/PRF layout.

## 2.1 ASR-9 FRONT-END RADAR PROCESSING

The ASR-9 DSP performs several front-end signal processing/thresholding operations prior to sending radar data to the 9PAC (or ASP prior to 9PAC Phase II) post-processor, illustrated in Figure 2-3 [3]. High- and low-beam data first passes through separate digital 0-63 dB STC attenuators to prevent receiver saturation at close range. Data from both beams are then input to a high-speed waveguide switch capable of switching between the high and low beam at some point during each pulse repetition interval (PRI). The crossover point is typically 15 nmi, with the high beam enabled at close range to reduce ground clutter contamination while the low beam is utilized at further ranges to provide adequate low-altitude coverage. The composite low-/high-beam data is fed to the radar receiver, which outputs 12-bit I and Q A/D samples. Individual radar pulses are then checked for RFI and receiver saturation and flagged if necessary. The A/D samples are passed through a Doppler filter bank, power combined, and subjected to Constant False-Alarm Rate (CFAR) and geocensoring operations before being output to the 9PAC.

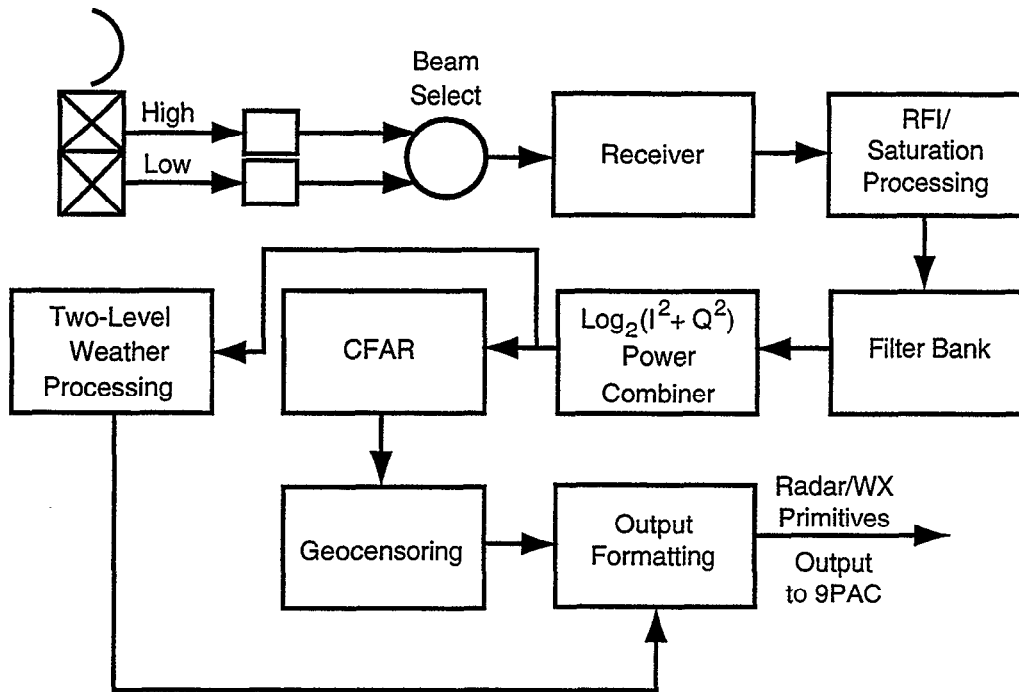

Figure 2-3. ASR-9 front-end signal processing.

### 2.1.1 Sensitivity Time Control

The Sensitivity Time Control (STC) attenuation vs. range used at a typical ASR-9 site is shown in Figure 2-4. The curve falls as  $1/R^4$ , providing for relatively constant point target amplitudes out to the range where the beam switch occurs or the STC attenuation reaches zero. Although the STC curves shown are typical, the STC decay rate can, in fact, be set independently for 12 range regions for adaptability to a variety of clutter environments. In general, because target amplitudes may vary with range and/or elevation, the C&I algorithms do not depend on absolute amplitude values, but instead utilize magnitude ratios during the centroiding process.

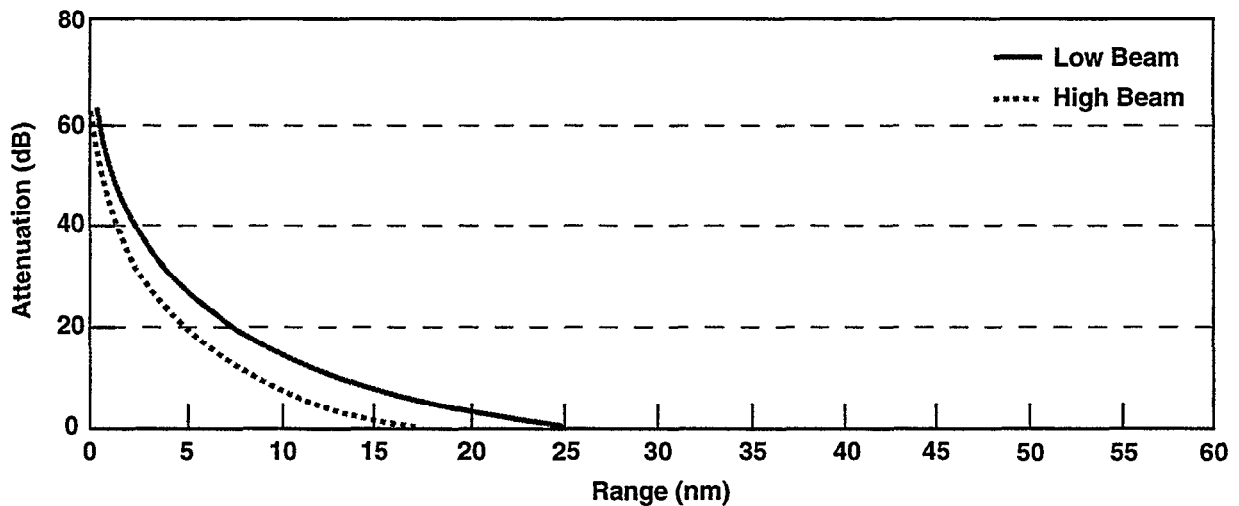

Figure 2-4. ASR-9 STC attenuation vs. range (typical).

### 2.1.2 RFI/Saturation Processing

Range gates in a single CPI that contain one or two pulses with significantly more power than expected, given the power in the other pulses and the azimuth beam pattern, are most likely the result of RFI interference from another radar. If any range gate within a single CPI exhibits these characteristics, the entire CPI is flagged to indicate the RFI condition. Individual range cells where receiver saturation occurred are also flagged at this stage.

### 2.1.3 Doppler Filter Bank

Following RFI/saturation processing, the A/D samples are input to a Doppler filter bank which produces 10 outputs for the high PRF CPI and eight outputs for the low PRF CPI. The filter bank bandpass characteristics are shown in Figure 2-5 (side lobes omitted)[4]. The filter outputs are referred to throughout C&I by the numbers shown in the figure, ranging from (-4) to (+4) for the high PRF and (-3) to (+3) for the low PRF. Filter numbers (+0,-0) are also referred to as the 'Zero-Velocity Filters' (ZVF), while all others are also referred to as the 'Non-Zero-Velocity Filters' (NZVF). The filtered I and Q time series data is converted to a power estimate (dB), and passed on to the CFAR function.

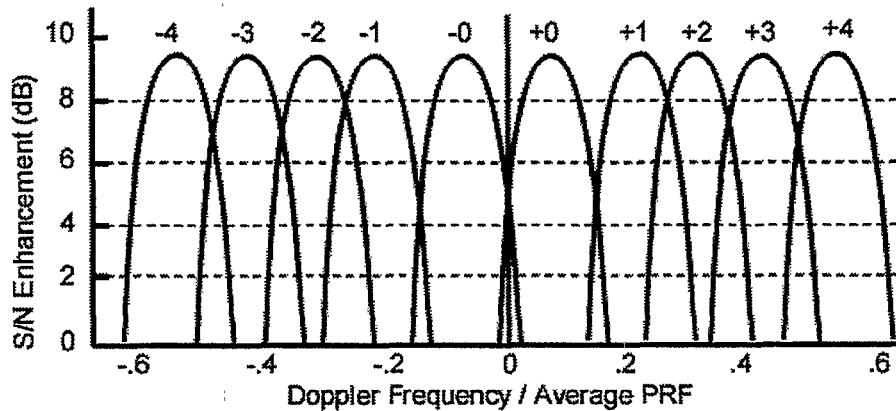

Figure 2-5. Doppler filter bank (high PRF).

### 2.1.4 CFAR

The CFAR acts to keep the number of radar primitives output to the ASP/9PAC to a manageable level. The CFAR logic is different for the ZVF and NZVF primitives due to the fundamentally different phenomena that produce the ZVF and NZVF returns.

**ZVF CFAR.** The majority of ZVF primitives are the result of stationary ground clutter and can be effectively filtered using a dynamic clutter map containing a smoothed history of the recent amplitudes at each individual range, azimuth cell. The ASR-9 uses the following smoothing function at each clutter map cell:

$$\text{SmoothedValue} = 7/8 * \text{PrevValue} + 1/8 * \text{NewValue} \quad (1)$$

The smoothed value is summed with a Variable Site Parameter (VSP) (typically set to approximately 12 dB) to produce the final ZVF+ or ZVF- threshold. Because nearby ground

clutter can be strong enough to cause residual power in the NZVF filters, a 'residue' map is maintained and a threshold generated using the same logic as above for all NZVF filters within the first 2 nmi. Depending on the environment at a specific site, a VSP can control whether the residue map threshold or the NZVF CFAR threshold is used for NZVF returns within 2 nmi.

**NZVF CFAR.** NZVF returns, by their very nature, change locations from scan to scan and cannot be thresholded utilizing a multiple scan history at a given cell. Instead, a sliding range window technique is used whereby the threshold for a given cell is determined by examining the 14 range gate window ending with the cell of interest (leading window) and the 14 range gate window starting with cell of interest (trailing window). Independent thresholds are determined for the leading and trailing windows, with the final threshold being the greater of the two. For each window, the threshold is determined by the following procedure:

1. Window Editing.

Certain cells in the window are excluded from contributing to the threshold generation. The cell of interest and its neighboring cell are always excluded. Cells tagged with RFI or Saturation flags are excluded. The remaining cells are then scanned, and the cell with the maximum amplitude is also excluded, as are the two closest cells to the maximum amplitude cell. This prevents a second aircraft target in the CFAR range window from raising the threshold.

2. Threshold Generation.

The amplitudes from the remaining cells in the window are then averaged and scaled by a 'Desired False Alarm Rate' VSP value to produce an appropriate threshold for the range window. Separate thresholds are maintained for all filter outputs.

At system start-up, the clutter map history is not present, and large numbers of ZVF targets pass through the thresholding step and are sent to the ASP. To prevent data overruns, the front end limits the number of ZVF primitives to 50 (nominal VSP setting) per CPI. If the count exceeds this number, then no more ZVF primitives are output for the CPI in question, and a flag set in the *next* CPIP azimuth header indicates that a ZVF overflow occurred.

### **2.1.5 Geocensoring**

The unmodified ASR9/ASP also performed a front-end geocensoring operation which removed or flagged primitives occurring over roadways. This function has been moved to the 9PAC in the new configuration, but a brief description of the original geocensoring logic is historically useful, as some of the features have been included in the new design. During site optimization, a 'Geo Map' was built utilizing a time-space history of radar-only targets and downloaded to EEPROM in the signal processor. Once installed, incoming primitives at a mapped location that fell below a selectable VSP threshold were rejected while those that were above the threshold were simply flagged. Each geocell could be specified as 'shaped' or 'flat,' with a set of five individual thresholds for the shaped category (for the +/-0, +/-1, +/- 2, +/-3, and +/- 4 filter 'classes') and a single threshold for the flat category that was used for all filters. The 'shaped' designation was originally intended for regions of strong ground clutter where the amplitudes (and the corresponding thresholds) would typically be higher in the low velocity filters. The 'flat' designation was intended for road traffic cells where target amplitudes are more evenly

distributed across all the Doppler filters. During the early FAA ASR-9 evaluation period, these intended meanings were superseded, and the designations “flat” and “shaped” are now used to represent geo cells at ranges less than 3 nmi and ranges greater than 3 nmi, respectively. The baseline flat threshold is set to 42.8 dB; geocensored primitives that are within 3 nmi and below 42.8 dB (typically clutter breakthrough, not automobile traffic) will be rejected while all others will be flagged. The five shaped thresholds are normally set to zero, resulting in all primitives at ranges > 3 nmi coinciding with a shaped geocell being simply flagged.

### 2.1.6 Two-Level Weather

The ASR-9 Target Channel is required to provide a backup weather detection capability in the event that the dedicated (non-redundant) weather channel should malfunction. Instead of the six-level representation provided by the weather channel, the target channel produces a simpler two-level output, where the two levels are user selectable (usually two and four). The levels are the standard NWS levels, with the following level-to-dBZ correspondence:

Level	dBZ	Level	dBZ
1	>18	4	>46
2	>30	5	>51
3	>41	6	>57

The two-level weather detection algorithm compares the average signal level (summed across all Doppler filters) at each range gate/CPI to predetermined weather data thresholds. The outputs from the thresholding step are then integrated spatially to form the tentative 0.5-resolution output detections for each CPI. The spatial integration logic declares a tentative detection at each 0.5 nmi (eight range gate) interval if at least eight of the previous 16 range gates crossed the weather threshold. To minimize the effects of second trip weather, tentative detections are required to be present in both the high PRF CPI and an adjacent low PRF CPI before being output as a single valid detection for the CPI pair. To prevent cells containing ground clutter from producing false weather detections, a clear day clutter map is created at site optimization time, and ZVF returns from flagged cells are excluded from the average signal level calculation. To provide for the two weather levels, a separate set of thresholds is used on alternate scans.

## 2.2 9PAC POST-PROCESSOR UPGRADE

The 9PAC is a hardware and software upgrade for the ASR-9 post-processor [1]. The ASR-9 post-processor is responsible for radar and beacon data processing, which consists of grouping the primitive inputs received from the front-end hardware (see Section 2.1) into completed target reports, and limiting the proliferation of "false" (i.e., non-aircraft) targets.

### 2.2.1 Post-Processor Hardware Upgrade

The post-processor actually consists of several processor and memory elements. The block diagrams in Figure 2-6 show the major elements of the ASR-9 post-processor in the pre-9PAC,



9PAC Phase I, and 9PAC Phase II configurations. In the original ASR-9 post-processor, illustrated in Figure 2-6a, the ASP performs the radar and beacon data processing; it reads the primitive input data from one memory card and writes target report data to another memory card. The Message Interface Processor (MIP) handles the interface between the ASP data processor and the communications system. The MIP also controls the interface to the Remote Monitoring System (RMS), which provides information to the operator console used to set up variable site parameters (VSPs) and examine performance monitoring data.

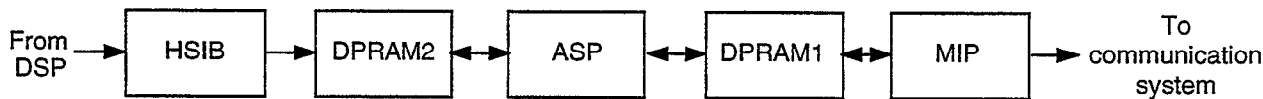

(a) Original ASR-9 post-processing configuration

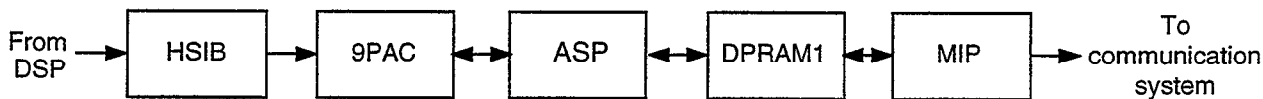

(b) ASR-9/9PAC Phase 1 post-processing configuration

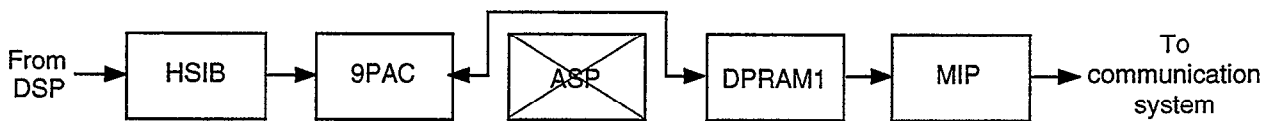

(c) ASR-9/9PAC Phase 2 post-processing configuration

*Figure 2-6. Evolution of the ASR-9 post-processing configuration.*

The 9PAC replaces one of the ASR-9 dual-port memory boards (labeled "DPRAM2" in Figure 2-6a). In addition to the original 64K of dual-port memory, the 9PAC contains three TMS320C44s (C44), 67 MBytes of memory, a 20 MByte Flash Memory Card (in a PCMCIA slot), and 4 ASYNC/SYNC serial ports. In its Phase I configuration, the 9PAC performs the beacon and radar-beacon target merge processing, while the ASP continues to handle the primary radar processing. Figure 2-6b provides a block diagram of the 9PAC Phase I post-processor. The 9PAC and ASP exchange radar and beacon target reports as needed to perform the data processing functions via the dual-port memory on the 9PAC board that replaces DPRAM2. The ASP sends the completed target reports to the MIP for dissemination.

In its Phase II configuration, the 9PAC replaces the ASP board set and assumes all of its functions; in fact, the ASP boards must be removed to avoid bus conflicts. The dual-ported memory (i.e., the 9PAC replacement for DPRAM2) on the 9PAC now controls the data path used to acquire radar/beacon primitive inputs from the HSIB. The Phase II 9PAC also has access to the ASR-9's second dual-port memory (DPRAM1) board via the ASR-9 backplane, allowing the 9PAC to communicate with the Message Interface Processor (MIP) in place of the ASP. Figure 2-6c shows a block diagram of the 9PAC Phase II post-processing elements.

Figure 2-7 illustrates the 9PAC hardware components, and it also shows the major software functions that run on each C44 processor. All three C44 processors have 1 MByte of zero wait-state static RAM. Processors #1 and #3 have 16 MBytes of single wait-state dynamic RAM, while processor #2 has 32 Mbytes (providing for the large C&I adaptive geocensoring maps). Processor #1 is used to communicate with all the peripherals (serial ports, flash memory card), as well as the on-board and external dual-port RAM. All three C44s are connected together via their high-speed (20 MBytes/sec) communications ports. The 9PAC has no global memory available for interprocessor communication, so all communication is accomplished via the high-speed ports.

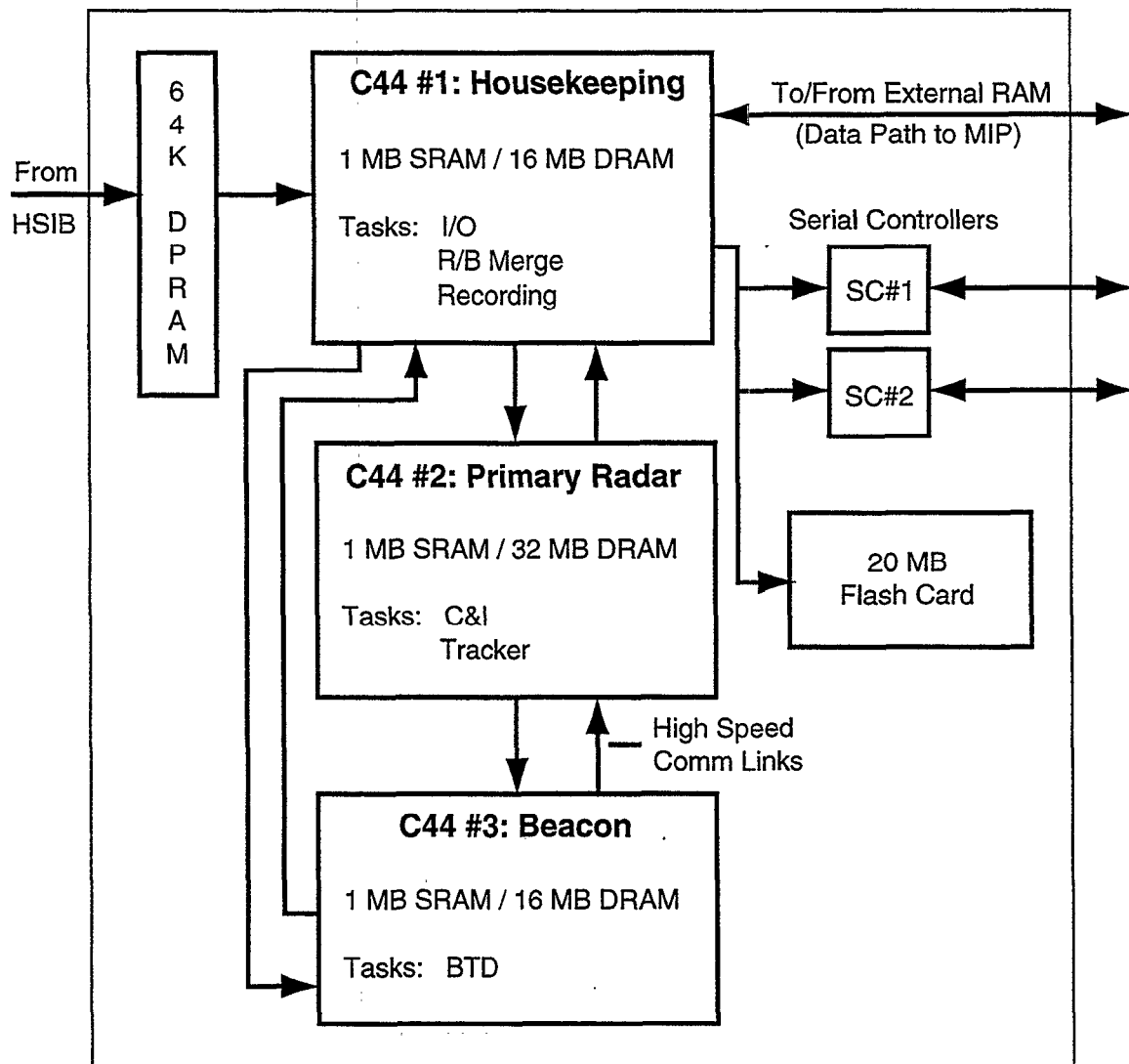

Figure 2-7. 9PAC block diagram.

### 2.2.2 Post-Processor Software Upgrade

Using the improved hardware capability provided by 9PAC, improved radar and beacon data processing algorithms were developed for the 9PAC software. Figure 2-8 shows the data flow

for the algorithms implemented in the original ASP-based post-processor. The radar and beacon primitive data provided by the front end consists of multiple detections for the same aircraft, as well as numerous false detections. The Beacon Target Detector (BTD) processing function performs the reply-to-target correlation process. The Correlation and Interpolation (C&I) processing function performs a similar function for the primary radar data. The radar and beacon target reports corresponding to the same aircraft are combined by a Radar-Beacon Merge function. The outputs of the Merge, which include radar-beacon, radar-only, and beacon-only reports, are disseminated via the communications system. The Merge output reports are also sent into the Tracker function in order to generate correlated output reports. The Tracker is only required to output correlated radar-only reports.

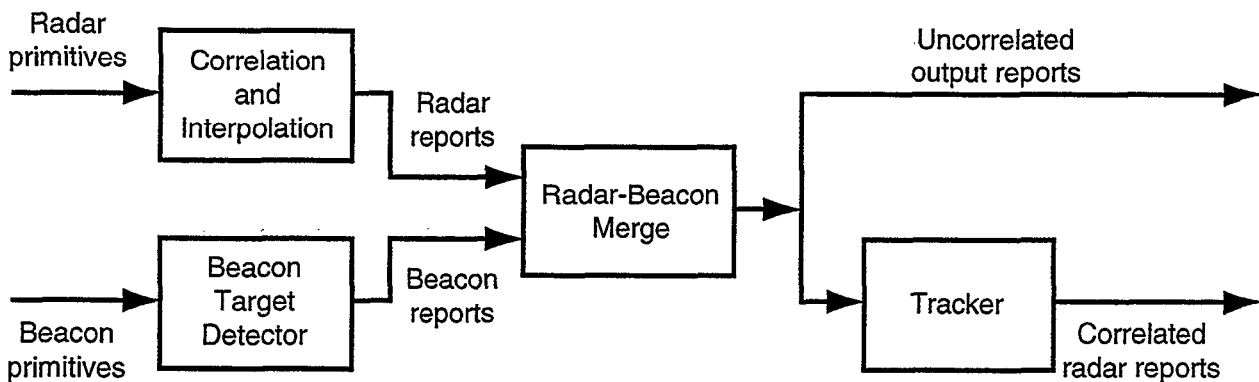

Figure 2-8. Data flow for the ASP-based post-processing algorithms.

9PAC Phase II provides improvements to each of the major post-processing algorithm functions. A diagram of the 9PAC radar and beacon algorithms and data flow is shown in Figure 2-9. The 9PAC BTD [8] improves the reply-to-target correlation algorithms, and also generates an automatic dynamic reflector database in order to remove beacon false targets. The 9PAC C&I, which is the subject of this report, automates the road and ground clutter (geocensor) map creation process, and provides improved false target filtering using a multi-layered adaptive map thresholding algorithm. The Radar-Beacon Merge [11] uses a "best-fit" algorithm, rather than the simple "first-fit" algorithm employed by the ASP-based merge function. The Tracker provides improved tracking of military aircraft, and uses Doppler processing and linearity testing to help reject non-aircraft radar tracks. The 9PAC provides feedback paths between its algorithm functions. The Merge and BTD exchange reports in order to ensure safe identification of beacon false targets. The C&I uses feedback from the Merge and Tracker functions to avoid over-aggressive false target filtering.

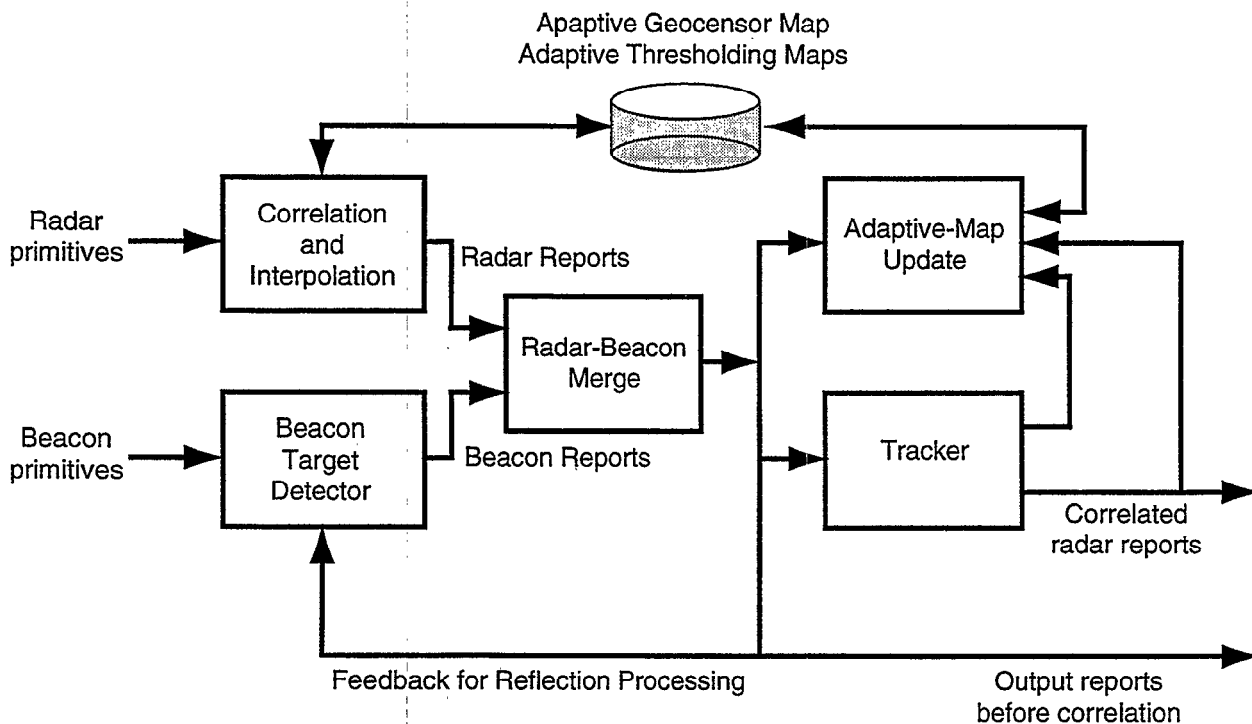

Figure 2-9. Data flow for the 9PAC Phase II post-processing algorithms.

The 9PAC source code is written using the "C" programming language. The code was developed in a portable fashion; it runs on UNIX platforms in an algorithm test bed [9]. However, the 9PAC hardware influenced the way in which some features were implemented. In particular, the smallest addressable word on the C44 processor is 32-bits ('char', 'short', 'int', 'float', and 'double' data types are all 32-bits). If memory conservation is an issue for a large data map, a programmer may explicitly pack 8 or 16-bit data fields within 32-bit words. Also, because a 'char' is the same size as an 'int,' some of the C&I structures use 'ints' where only eight bits of precision is necessary. The data structures of this type are relatively small in number and the memory wasted has not been significant.

### 2.3 OPERATION WITH THE MODE S SENSOR

At United States airports, the ASR-9 is usually co-located with a Mode S sensor, which is a monopulse secondary surveillance radar, or MSSR. Therefore, 9PAC Phase I and Phase II must function appropriately with the Mode S sensor if it is present. There are two modes of operation for the ASR-9/Mode S combined system: interim beacon interrogator (IBI) mode, and MSSR mode. With regard to 9 PAC, the difference between the two modes is where the beacon target detection and radar beacon reinforcement (a.k.a., the Merge) functions are performed. In IBI mode, the Mode S sensor only functions as a beacon interrogator, and the 9PAC performs the beacon target detection and radar beacon reinforcement. In MSSR mode, the Mode S sensor performs the interrogation, target detection and radar reinforcement functions. When an ASR-9 system operates without a co-located Mode S sensor, the 9PAC still performs the beacon and merge functions, but the beacon data is provided by a different beacon interrogator (e.g., BI-4, BI-5, BI-6).

In the 9PAC Phase I configuration, the ASR-9 ASP performs the primary radar functions, and the 9PAC only performs beacon and merge processing in IBI mode. In MSSR mode, the 9PAC Phase I is merely a replacement for one of the ASP dual-port memory cards.

In the 9PAC Phase II configuration, however, the 9PAC primary radar algorithms described in this report function in coordination with the beacon processing algorithms that are resident in either the 9PAC for IBI mode or the Mode S sensor for MSSR mode. Additional technical information and software block diagrams regarding Phase II operation in IBI and MSSR mode is provided in [12].

The timing of the disseminated data relative to the antenna position is different in the two modes of operation. In the IBI mode, all data is contained within the 9PAC and dissemination has less latency. In the MSSR mode, dissemination is slightly slower because of the need to exchange data between the Mode S and 9PAC processors and because of timing constraints imposed by close in targets on the MSSR discrete interrogation operation.

It should be noted that the FAA is planning to upgrade the ASR-9/Mode S sensor in the future to disseminate data via the ASTERIX format in lieu of the 1960 vintage CD-2 formats presently used. Lincoln Laboratory has provided the FAA with a white paper on various options for this upgrade [13]. Some options involve dissemination from the Mode S sensor, in which case the 9PAC radar-only correlated (i.e., track) data would be transferred to the Mode S sensor for dissemination as correlated radar data. Alternatively, some 9PAC algorithms could be implemented within the Mode S sensor to perform the scan-to-scan processing (i.e., tracking function described in [7]) in Mode S and thereby reduce the latency in the reporting of this correlated data. No more details on these options or tradeoffs are contained in this report.



### 3. C&I REQUIREMENTS

The following C&I system requirements were culled from the original system specification document [5].

The C&I is required to handle a maximum of 700 aircraft targets plus 300 non-aircraft targets per scan (max. of 31000 primitives), with the following additional peak loading characteristics:

- A peak of 250 total targets (max. of 11000 primitives) uniformly distributed across eight contiguous 11.25 degree sectors (90 degrees of antenna scan).
- A peak of 100 total targets (max. of 4400 primitives) uniformly distributed across two contiguous 11.25 degree sectors.
- A short-term peak of 16 targets (max. of 1200 primitives) in a 1.4 degree azimuth wedge, lasting for not more than two contiguous wedges.

The ASR-9 specification requires that the maximum C&I boresight delay is 0.14 seconds, which corresponds to 109 ACPs at the slowest antenna rotation rate. Delay is defined as the difference in azimuth between a given target's azimuth centroid and the current antenna boresight position at the time of actual output to the 9PAC or Mode-S Merge process.

If target load exceeds the peak requirement and the allowable boresight delay is exceeded, the C&I processing is required to reduce the processing range starting from the outer range limit until the delay returns to an acceptable level.





## 4. 9PAC C&I ALGORITHM DESCRIPTION

The C&I algorithms are responsible for correlating the raw radar primitives into groups and interpolating between the primitives in each group to produce target centroid, amplitude, and Doppler estimates. A block diagram of C&I is shown in Figure 4-1. Each of the separate functions is explained in detail below.

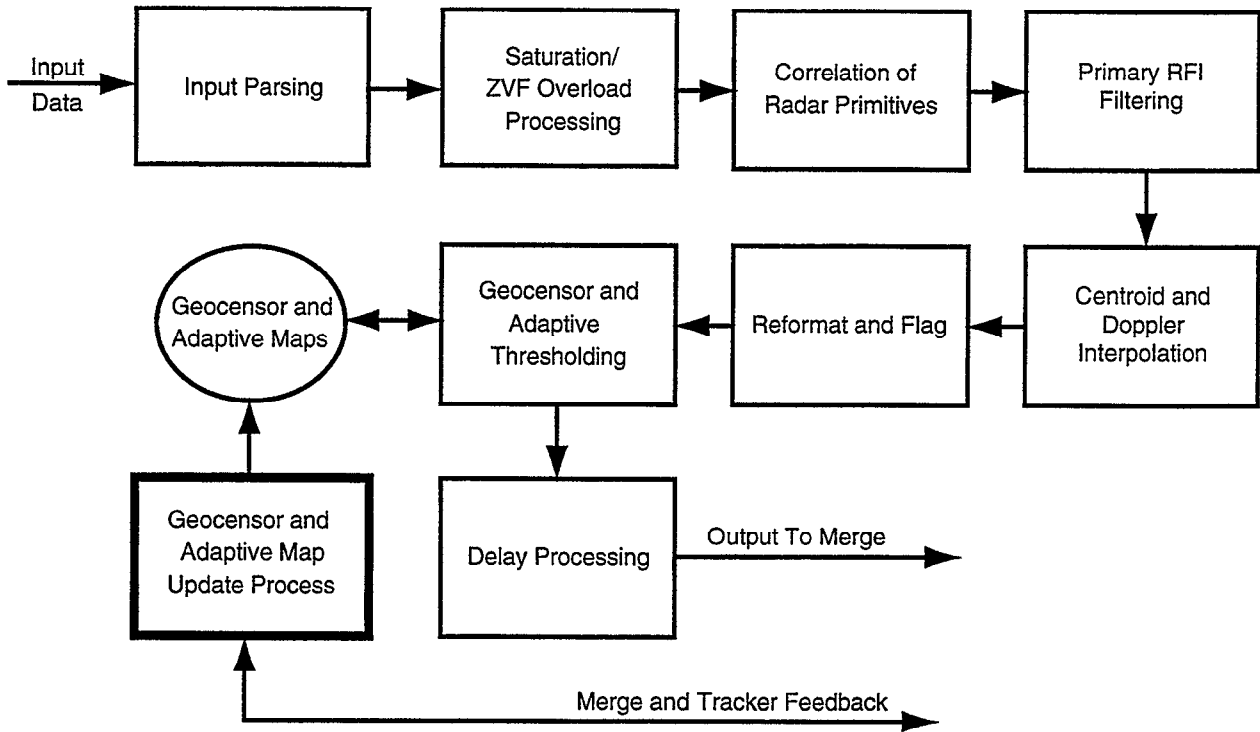

*Figure 4-1. C&I processing block diagram.*

Radar primitives from the ASR-9 are passed to the input parsing module which validates the data, and groups the primitives into contiguous range groups for subsequent processing. The range groups for each CPIP are checked for a saturation or ZVF overload condition, followed by a correlation of the radar primitives across multiple CPIPs to form a radar target. Targets are then subjected to a filtering step that removes highly probable RFI targets. Surviving targets are scanned to locate the highest quality radar primitives, and interpolated values of the range and azimuth centroids, as well as the target's Doppler velocity, are produced. A supplemental RFI test is used to flag (not delete) targets that are most likely due to RFI and were not detected by the primary RFI test. Following a reformatting operation, the targets are subjected to a geocensoring and multi-grid adaptive thresholding process to flag/remove false detections due to roads, birds, and weather. Prior to final output to the Merge process, targets are checked for excessive boresite delays (due to heavy CPU loading). Excessive delays cause the C&I processing range to be reduced until the delay drops back to an acceptable level.

To avoid including aircraft in the geocensoring/multi-grid map statistics (and possibly raising the thresholds unnecessarily), the thresholding counting process is not performed on the report stream flowing through C&I, but is deferred until after the merge to allow radar reports associated with a beacon return to be excluded from the count. In the 9PAC implementation, the counting/update process is run as a separate task that taps into the merge output stream to facilitate this.

#### **4.1 INITIALIZATION/RESET**

Before any processing takes place, C&I must be initialized. Initialization consists primarily of allocating memory for all the C&I data structures, which is done up front to avoid memory fragmentation problems.

The processing range is set to the full range of the radar, 60 nm. The geocensor map, if present, is loaded from either the flash card (9PAC) or disk file (UNIX). The fine and coarse adaptive map thresholds are zeroed, as are their target count arrays. A set of default VSPs is loaded, which is mainly of use when executing the code off line (under UNIX). The 9PAC startup code always waits to receive C&I VSPs to avoid any possible confusion. The final initialization step is to call the C&I reset routine.

A reset of C&I resets the input state machine, flushes the input buffer, and clears the active and mature target lists. Current processing range, geocensoring thresholds, and adaptive thresholds are not affected, to prevent loss of information which must be preserved across input-error-induced resets (see below).

#### **4.2 INPUT PARSING**

The input processing function serves two purposes: synchronization/validation of the input stream, and a first-stage grouping of contiguous range cells.

The input stream consists of azimuth headers/data, range headers/data, CPI headers/data, and two-level weather headers/data. Data is not present for all range gates - only for those containing at least one radar primitive that exceeded the front-end CFAR thresholds. Likewise, at each range gate, only the filter amplitudes that exceeded their corresponding CFAR thresholds are present. Each type of header (az, range, CPI, WX) has a unique three-bit code, allowing for a simple state-machine to be implemented to verify the incoming data. A detailed description of the input data format is provided in Appendix B.

As the input data are parsed, range cells that are contiguous are grouped together. The maximum number of range cells in a group is nine (sufficient range extent to deal with the two-target case) after which the current group is terminated and a new group started. At the end of each CPIP (signaled by the arrival of the next CPIP's azimuth header), the groups are passed to the subsequent target formation routines.

The input state machine contains a number of checks to ensure data validity. In general, an unexpected sequence of data resets the state machine to wait for the next azimuth header, and the remainder of the current CPIP is discarded. Azimuth values of neighboring CIPs are also tested. A jump of more than 32 ACPs is considered an error and the CPIP is discarded. If three consecutive azimuth errors occur, an alarm is set and the C&I reset routine is executed.

The original ASR-9 carried a geocensor/MTI flag for each primitive to identify primitives that are located within a geocensor cell. However, the current 9PAC Phase II C&I design does not use geocensoring of primitives. Also, the original ASR-9 shaped/flat geocensoring has been abandoned, and is not included in the 9PAC Phase II implementation. The 9PAC's geocensoring strategy relies primarily on target centroids, both to produce the geomap and to perform the actual censoring operation, in order to keep the geomapped regions as confined as possible (see Section 5 for more details). Although, the geomap is generated and used at a later stage in C&I, it is also available at the front-end of C&I and could be used to flag data at the primitive level.

### 4.3 SATURATION AND ZVF OVERFLOW PROCESSING

When receiver saturation occurs, it is undesirable to permit radar primitives in the vicinity of the saturated cell from initiating a new target, as an inaccurate range centroid may result. To avoid this, all radar primitives within  $-2,+4$  range counts of a saturated cell on the same CPI are flagged to prevent target initiation.

Usually, the front end ZVF CFAR clutter map limits the number of ZVF primitives to a few hundred per scan at most. However, when the map is not fully initialized, such as when the radar is turned on, large numbers of ZVF primitives can reach the 9PAC. The front-end signal processor declares an overflow when the number of ZVF primitives in any CPI exceeds 50. When an overflow occurs, the subsequent ZVF detections are removed for the remainder of the CPI, but the ZVF primitives prior to the overflow being detected are output to the 9PAC and are a potential source of false alarms. The 9PAC, like the ASP, discards these excess ZVF primitives, utilizing the ZVF overflow bits in the following CPIP's azimuth header (which indicate an overflow condition existed on the *previous* CPIP). The 9PAC does not begin processing the current CPI until the header for following CPIP is detected. Note that the removal of ZVF primitives can result in the removal of range cells, and in some cases entire range groups, if there are no NZVF detections in the range cell or group.

### 4.4 CORRELATION OF RADAR PRIMITIVES

The C&I correlation process groups the radar primitives into targets. As successive CIPs of data are processed, radar primitives that correlate with an active target at the same range are incorporated into the existing target. Primitives that fail to correlate with an active target initiate a new target. Active targets that fail to get updated with additional primitives over the course of a CPIP, or reach seven CIPs in azimuth extent, are declared to be a "mature" target group and are forwarded to the next step in the processing chain (RFI Processing).

#### 4.4.1 Target Initiation

A new target is initiated whenever a series of one or more primitives is encountered that fails to correlate with an existing target. The first three cells in the range group are searched to find the maximum amplitude. Cells that are inhibited from initiating a target due to nearby saturation are excluded from the maximum amplitude search. The maximum amplitude cell becomes the range centroid ( $R_c$ ) of the target. The primitives on adjacent range cells are examined (if existing), and the cell with the maximum amplitude declared the adjacent cell,  $R_{adj}$ . As new CIPs of data are integrated into the target, detailed data is maintained for only these two key cells. Note that if no adjacent data exists at the CPI responsible for target initiation, then at each subsequent CPIP an

attempt is made to establish an adjacent cell. Normally, an adjacent cell will be present in the first or second CPIP, although for weak single range gate targets it is possible to complete the target without an adjacent cell. Following the determination of  $R_c$ , the target update routines are executed as for subsequent CPIPs to add the appropriate data to the target data structure.

#### 4.4.2 Target Updating

As the primitives from successive CPIs are grouped into radar targets, tests are performed to detect targets that are closely spaced in range and are producing overlapping range groups. In either case, primitives from  $R_{c-1}$  to  $R_{c+1}$  are associated with the target centered at  $R_c$  and are used to update the active target structure. In the single-target case, primitives at  $R_{c-2}$  and  $R_{c+2}$  are also grouped into the target at  $R_c$ , although they are not used to update the target data fields. If a primitive at  $R_{c+3}$  exists, it is not associated with the target at  $R_c$ , but it is inhibited from initiating a new target. If there are any additional contiguous primitives in the raw range group and a new target is initiated, then the primitive at  $R_{c+3}$  will be included in the second target. An example of a single-target primitive range group is shown in Figure 4-2a. Note that the majority of aircraft returns do not span the range extent shown in the example but are typically only three or four range cells in length.

##### a) Single-Target Example

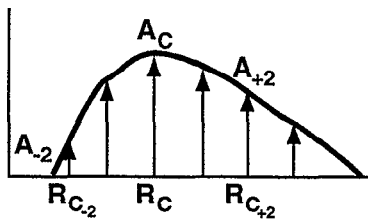

$$-A_C / A_{-2} \geq \text{Predicted} - \text{No leading second target}$$

$$-A_C / A_{+2} \geq \text{Predicted} - \text{No trailing second target}$$

##### b) Two-Target Example

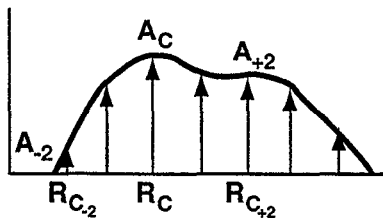

$$-A_C / A_{-2} \geq \text{Predicted} - \text{No leading second target}$$

$$-A_C / A_{+2} \geq \text{Predicted} - \text{No leading second target}$$

Figure 4-2. Detection of multiple targets in a primitive range group.

When two aircraft are in close proximity, the amplitude vs. range relationship will not exhibit the same rise/fall characteristics as a single target but will instead appear more like Figure 4-2b. The presence of multiple targets can be detected by examining the amplitudes surrounding the cell at  $R_c$ . If data exist at  $R_c$ ,  $R_{c-1}$ , and  $R_{c-2}$  (leading range split test) or  $R_c$ ,  $R_{c+1}$  and  $R_{c+2}$  (trailing test), and none of the data is flagged as saturated, then the amplitude ratio  $A_c/A_{c-2}$  or  $A_c/A_{c+2}$  is tested to see if it falls within the limits expected for a single target. If not, a target split is declared and the data at  $R_{c-2}$  or  $R_{c+2}, R_{c+3}$  is not associated with the current target but is allowed to associate with other targets or initiate a new target. If a split is declared at the leading edge of the group ( $R_{c-2}$ ), then the test for a split at  $R_{c+2}$  is not performed. Unlike the ASP version, the 9PAC allows multiple target splits as primitives from successive CPIs are added to the target. The

specific tests used for the range split determination, using log domain amplitude data (3/32 dB), are:

Leading range split: if  $(A_c - A_{c-2}) < 200$  ) Declare leading range split

Trailing range split: if  $(A_c - A_{c+2}) < 117$  ) Declare trailing range split

The threshold values are compile-time constants and cannot be changed via VSPs.

One special case exists to limit the interference effects of two closely spaced (in azimuth) targets that are separated by a sufficient amount in range to trigger the range split logic (St. Louis parallel approach problem). In this case, if a range split occurs but the target is already at least two CPIs in run length, then the existing active target is terminated without integrating any of the primitives on the current CPI and the primitives are used to generate a new, separate target. This new target is pre-initialized to a range split.

During the association process, a certain amount of processing and data reduction takes place to reduce the overall storage requirements and to reduce the amount of computation that must be performed once the target group has been completed. As mentioned above, filter data from associated cells at ranges other than  $R_c$  or  $R_{adj}$  is discarded. The filter magnitudes at each CPIP are distilled into six categories, three at each PRF. The three categories are:

- Zero velocity data at  $R_c$
- Non-zero velocity data at  $R_c$
- Non-zero velocity data at  $R_{adj}$

The maximum filter amplitude in each category (if existing) is selected and stored in the target data structure. All other filter magnitudes are discarded.

In addition to the combined filter magnitudes, an interpolated Doppler value is determined for the cell at  $R_c$  using the peak filter magnitude and the adjacent filter magnitude.

#### 4.4.3 Active Target Termination

An active target is considered to be complete when any of the following occur:

1. No primitives update the target for two consecutive CPIs. In the simplest case, there is no new data for either CPI in a CPIP, and the active target can be terminated on that CPIP. The second case is when there is a miss on the low PRF CPI in one CPIP followed by a miss on the high PRF CPI on the following CPIP (even though there is a hit on the low PRF CPI). This is flagged as an azimuth split case, with the most recent CPIs low PRF primitives possibly initiating a new target.
2. A hit/miss/hit pattern exists for either PRF. Although the association algorithm allows an all-miss scenario for either PRF to accommodate blind speeds, a hit/miss/hit pattern on either PRF is not allowed and is treated as an azimuth split. The current CPIP's data are not associated with the active target (which is terminated) and is permitted to associate with another target or initiate a new target. Note that for this

scenario to be invoked, the target must already have at least two CIPs worth of data prior to the CIP being added.

3. The target runlength exceeds seven CIPs.

Once an active target is declared finished, it is placed on the completed target list which is passed to the next stage of processing.

## 4.5 RADIO FREQUENCY INTERFERENCE PROCESSING

When Radio Frequency Interference (RFI) occurs in the same range cell as ground clutter of comparable magnitude, the front end pulse-to-pulse RFI filter is rendered ineffective. After the Finite Impulse Response (FIR) filtering and CFAR operations, the clutter will be eliminated but the broad spectrum RFI signal will typically result in the generation of multiple NZVF primitives. Two mechanisms exist in C&I to reduce the effects of the RFI 'breakthrough'. The first, termed 'Primary RFI Processing,' removes targets that are only a single CPI (one PRF) in azimuth extent and contain more than RFI\_HI\_THR (5) or RFI\_LO\_THR (5) NZVF primitives. Analysis has shown that targets with these characteristics have a very high probability of being RFI false alarms. Primary RFI processing occurs immediately following radar primitive association to prevent false alarms of this type from reaching the centroiding process (reduces CPU utilization).

In environments with substantial amounts of RFI, some false targets will still leak through the front-end test and the C&I test described above. A second test, 'Supplemental RFI Processing,' can be used to handle additional RFI targets. Enabled by the VSP SUPP\_RFI\_ENABLE, the Supplemental RFI test counts the number of single-CPI targets in a given five-degree wedge and deletes all of them if there are more than SUPP\_RFI\_DEL\_THR in the wedge. Note that the Supplemental RFI test, when enabled, delays all single-CPI target by up to five degrees to accomplish the counting process.

The Supplemental RFI test, originally developed for the ASP-based C&I, utilizes target azimuth centroids. For this reason, the test must be performed following the centroiding function, unlike the Primary RFI test. The 9PAC Supplemental RFI test is performed after the geocensor map threshold comparison (see Section 5.2). This was done in order to prevent single-CPI geocensor targets from being mistakenly counted as RFI. This was a problem with the original ASR-9 implementation, since it increased the likelihood of mistakenly setting the Supplemental RFI performance alarm.

## 4.6 INTERPOLATION

Interpolation techniques are used to produce the final range and azimuth centroids as well as high and low PRF Doppler estimates. The Doppler estimates are used to calculate radial velocity, which is used in the adaptive map thresholding process discussed in section 5.3.

### 4.6.1 Range Interpolation

A target's initial range centroid is determined by picking the range cell with the greatest amplitude and is therefore accurate to within  $1/16^{\text{th}}$  nmi, the range gate size. This estimate can be improved upon by comparing the amplitude at  $R_c$  with the amplitude at the adjacent cell (the

next largest amplitude by definition). If the two amplitudes are sufficiently close, then a range 'straddle' is declared and the target range is corrected by +/- 1/32 nmi. (This is the final range accuracy of C&I even though the range is output in units of 1/64 nmi).

The range straddle amplitude comparison is performed on the CPIP at which the adjacent cell is established. Data from both PRFs are checked - a range straddle condition can be declared if either PRFs data indicates it. At each PRF, the peak filter amplitude is selected for both  $R_c$  and  $R_{adj}$ . If there are no data at  $R_c$  on the current CPI, then a range straddle is immediately declared. If  $R_c$  data are present and  $(Amp_c - Amp_{adj}) < 49$ , a straddle is declared (amplitudes and threshold in units of 3/32 dB). The threshold of 49 is a compile-time constant and is the same value used in the original ASP implementation.

In addition to the range straddle correction, a constant range bias of 1/32 nmi is added to compensate for the ASR-9 time-to-first range gate.

## 4.6.2 Azimuth Interpolation

The azimuth interpolation process is more complex than the range interpolation in part because the azimuthal resolution of the radar has been somewhat reduced by the front end FIR filter (pulse integration), and additional computation is required to recover the lost accuracy where possible. First, a search is performed across all CPIs in the target to find the highest quantity/quality data set that is available, and then one of five algorithms is chosen for azimuth determination.

### 4.6.2.1 Azimuth Centroiding Data/Algorithm Selection

A scoring procedure is used to select the highest quality set of data from among the six different types of filter data stored in a target report. (Three at each PRF: ZVF\_RC, NZVF\_RC, and NZVF\_ADJ)

The following general rules are used to select the optimal set of data.

- NZVF data are preferred over ZVF data.
- Longer runlengths are preferred.
- The use of data from the same PRF is preferred over data from different PRFs.
- $R_c$  data are preferred over adjacent cell data.
- Data with the beamswitch or saturation flag always score lower than data without, regardless of runlength.

The meaning of the score values as implemented in the C code is as follows:

0	No hits for the data type	4	Runlength = 1 CPI
1	Long runlength ( $\geq 7$ CPIs)	5	Runlength = 2 CPIs
2	Beamswitch condition	6	Runlength between 3 and 6 CPIs

### 3 Saturation condition

One special case exists—if there is any NZVF data type with a runlength of two or greater, then the ZVF data is not used, even when it has a longer runlength than the NZVF data.

Once the scores have been established for each data type they are compared, and a six-bit mask is produced containing a 1 for every data type that ties the maximum score. The mask value is used in combination with the score value as an index into a two-dimensional lookup table that selects the centroiding algorithm and input data set based on the general rules above.

There are five fundamental algorithms used for azimuth centroiding. They are:

1. Single CPI
2. Two-PRF Interpolation (two CPIs, different PRFs)
3. Single-PRF Interpolation (two CPIs, same PRF)
4. Beamshape Match ( $\geq$  three CPIs, same PRF)
5. Beamsplit ( $\geq$  seven CPIs - long runlength)

The individual algorithms are described in detail in the following sections.

#### 4.6.2.2 Single CPI

This algorithm is used when data is available at only a single CPI. This is the trivial case since no interpolation is needed. The target azimuth is simply set to the azimuth of the single CPI.

#### 4.6.2.3 Two-PRF Interpolation

In this case, data are available from two adjacent PRFs, i.e., a high/low or low/high sequence. This is not the optimal case because of the filter magnitude fluctuations that can occur due to the differing PRFs, so azimuth beamshape information is not utilized. A more complicated algorithm is probably not warranted in any case because the azimuth correction is limited by the azimuth span of the data to approximately eight ACPs. A simple center of mass algorithm is employed:

$$\text{Centroid} = ((\theta_1 A_1 + \theta_2 A_2) / (A_1 + A_2))$$

This can be rewritten as:

$$\text{Centroid} = \theta_1 + K(\theta_2 - \theta_1)$$

where:

$$K = A_2 / (A_1 + A_2)$$

This algorithm assumes that  $A_1$  and  $A_2$  are linear target amplitudes that are consistent from one PRF to another. Prior to the centroiding computation, the amplitudes are converted to linear units



and a 1 dB correction is added to the low PRF magnitude to compensate for high-low filter gain difference.

To protect against antenna north crossings, the more complete equation is:

$$\text{Centroid} = \text{Modulo}4096\left(\theta_1 + K\left(\text{Modulo}4096(\theta_2 - \theta_1)\right)\right) \quad (1)$$

#### 4.6.2.4 Single PRF Interpolation

The algorithm is used when two CPIs of data at the same PRF are available. Because the azimuth gap between successive CPIs at the same PRF is fixed at 16 ACPs and the antenna's azimuth beam pattern is known, the ratio of the amplitudes on the two CPIs can be used in conjunction with the beamshape to generate an interpolated azimuth. The equation used in this case is:

$$\text{Centroid} = \theta_1 + \frac{1}{2}(\theta_2 - \theta_1) + K_{\text{Beam}}(A_1 - A_2)$$

where  $K_{\text{Beam}}$  is a correction constant determined separately for each beam, and  $A_1, A_2$  are log amplitudes. This process is illustrated in Figure 4-3. The true azimuth centroid for a two-CPI target with amplitudes proportional to  $A_1$  and  $A_2$  is clearly not at the midpoint between the two CPIs but lies closer to  $A_2$  by the angular quantity that provides the best fit between the actual amplitude difference and that predicted by the beamshape pattern (four ACPs in this case).

The predicted amplitude difference vs. azimuth offset is highly linear in the +/- 16 region of interest, and the constant  $K_{\text{Beam}}$  can be easily obtained. The relationship for the low beam is shown in Figure 4-4. A least squares fit of the data results in a  $K_{\text{Beam}}$  value of -0.307 for the low beam and 0.388 for the high beam.

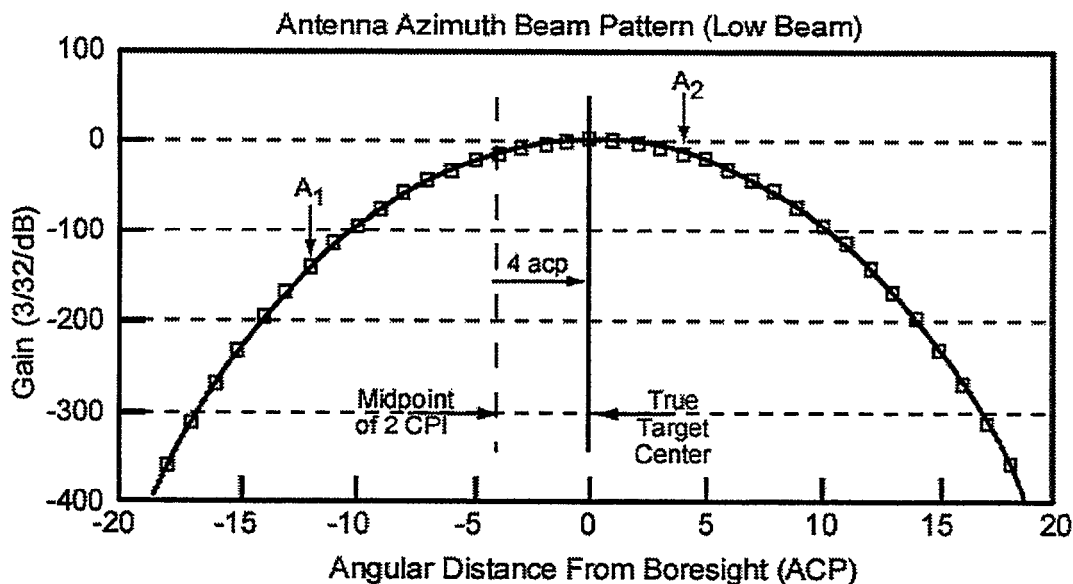

Figure 4-3. Antenna azimuth beam pattern (low beam).

To again account for the north crossing, the final form of the equation is:

$$\text{Centroid} = \text{Modulo}4096 \left( \text{Modulo}4096 \left( \theta_1 + \frac{1}{2}(\theta_2 - \theta_1) \right) + K_{\text{Beam}}(A_1 - A_2) \right) \quad (2)$$

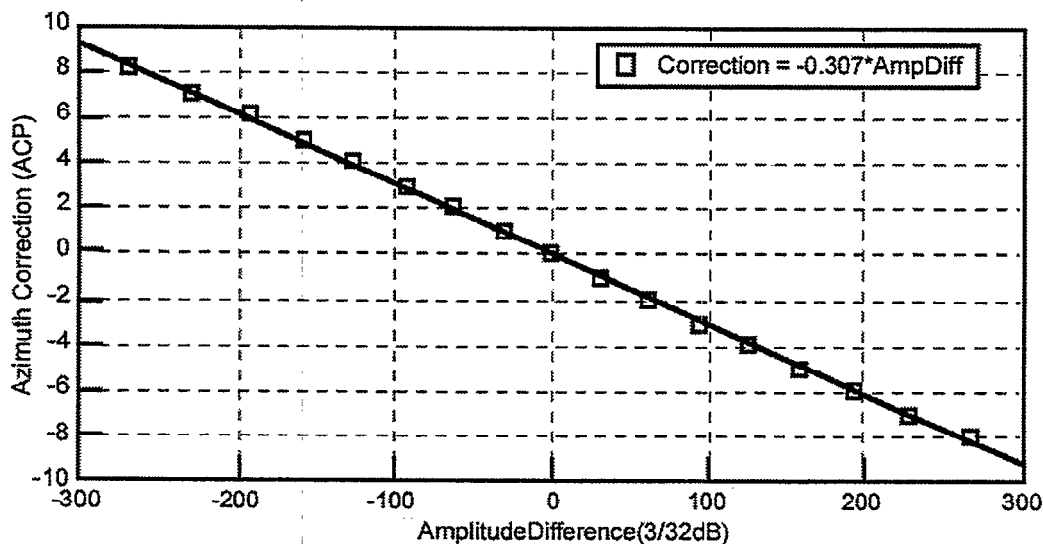

Figure 4-4. Azimuth correction vs. CPI amplitude difference.

#### 4.6.2.5 Beamshape Match

When three or more CPIs of data are available, the beamshape match algorithm is used. This algorithm computes the error between the known beamshape and the target amplitudes for a range of possible target azimuths and selects the azimuth with the minimum error as the target azimuth. If the minimum error exceeds a threshold, it is assumed that multiple targets are present and a target split is performed.

Only three data points are used by the match processing. If there are more than three CPIs of data available, the most 'central' set of data is selected for use. The rules below describe the data selection algorithm, which depends on the number of CPIs present and the relative amplitudes at each CPI. The CPIs are identified by the letters 'a', 'b', 'c', etc. The notation "a > d" indicates an amplitude comparison between the data at CPI 'a' and 'd'.

1. Four CPIs a, b, c, d  
If a > d, (a,b,c) are used, otherwise (b,c,d) are used.
2. Five CPIs a, b, c, d, e  
(b,c,d) are always used.
3. Six CPIs a, b, c, d, e, f  
If a > c (a and b) are used, otherwise (b and c) are used for the left target.  
If d > f (d and e) are used, otherwise (e and f) are used for the right target.

The following discussion uses A, B, and C to refer to the central data set, with A representing the counterclockwise 'edge.'

The beamshape match process makes the assumption that the true target centroid lies within  $\pm 8$  ACPs of the azimuth of the center amplitude ( $\theta_B$ ). This requires that the antenna beamshape pattern for a  $\pm 24$  ACP window be stored in a table and used in the comparison process. (If the true centroid azimuth lies at the maximum bound of  $\theta_B+8$  ACPs, then  $\theta_A$  is located 24 ACPs earlier than the centroid due to the 16 ACP spacing of successive CPIs at the same PRF). To test all possible azimuths in the  $\pm 8$  ACP window, 17 iterations are required. The error for each iteration is determined by the following equation:

$$Err = \left( \left( \frac{M_A}{M_B} \right) - \left( \frac{P_A}{P_B} \right) \right)^2 + \left( \left( \frac{M_C}{M_B} \right) - \left( \frac{P_C}{P_B} \right) \right)^2 \quad (3)$$

where  $M_A, M_B, M_C$  are the voltage equivalents of the measured target amplitudes, and  $P_A, P_B, P_C$  are the predicted voltage values based on the stored antenna pattern. The error computation is performed in the voltage domain because the maximum error between the actual antenna pattern (whose azimuth beamshape varies as a function of frequency and elevation angle) and the ideal stored pattern is more constant across the azimuth region of interest when voltage values are used in place of power [5].

Once the minimum error has been determined, it is checked to determine if it is within an acceptable range for a single target. If so, the azimuth is set to the azimuth that produced the minimum error value. If not, the target is split into two targets. The method used for target splitting depends on the target runlength. If the runlength is four or five, then the single PRF interpolation is used on the first two hits and the last two hits to produce the azimuths for the split targets. If the runlength is three, the azimuths for the two targets are simply set to the leading edge azimuth plus 1/4 or 3/4 of the target runlength. Note that the new target created by the split process is simply a copy of the old target, sharing the same hit history, runlength, etc. No attempt is made to go back and intelligently split any of the fields (the hit history, for example) between the two targets. Most fields that would be candidates for splitting are never used following centroiding, so a more sophisticated algorithm is unnecessary.

The 9PAC implementation of the beamshape match is substantially simpler than the ASP version, which utilized multiple layers of lookup tables and approximations to compensate for lack of floating-point capabilities. The original ASP 3/32 dB beamsplit error thresholds were:

Low Beam: ASP value (3/32 dB): 175

High Beam: ASP value (3/32 dB): 150

The 9PAC "C" implementation does the beamshape error computation in linear units and includes the "-" sign, resulting in the following constants:

Low Beam 9PAC value:  $-175 * (3/32) = -16.40625 \text{ dB} = 0.022875732 \text{ linear units}$

High Beam 9PAC value:  $-150 * (3/32) = -14.0625 \text{ dB} = 0.039241898 \text{ linear units}$

#### 4.6.2.6 Beamsplit Algorithm

The beamsplit algorithm is used when the beamswitch or saturation flags are present or the target runlength reaches seven CPIs. In these cases, the data quality is not high enough to utilize the antenna beamshape. The target azimuth is obtained by simply bisecting the leading edge and trailing edge azimuths, taking both low and high PRF data into account.

#### 4.6.2.8 Algorithm ID Tagging

In order to facilitate subsequent data analysis, each target is tagged with an ID ranging from 0-57 to identify the algorithm and data set used to calculate the target centroid. Additionally, solely for analysis purposes, the 9PAC adds 80 to the algorithm ID if any of the target's primitives were flagged as geocensored by the original ASR-9 hard-coded geocensor map. This analysis code should eventually be removed, or else the 9PAC adaptive geocensor map should be used as the basis for adding a fixed offset to the algorithm ID. The centroid algorithm IDs are documented in Appendix D.

#### 4.6.2.9 Azimuth Correction for Sampling and Signal Propagation Errors

Before final output, two minor corrections are made to the target azimuth. The first correction is necessary to correct for the azimuth sampling error. Ideally, for the high PRF (10 pulses), the azimuth sample would represent the azimuth halfway between pulse five and pulse six. Instead, the ASR-9 samples at the beginning of pulse six of the ten-pulse sequence (and pulse five of the eight-pulse low PRF sequence), so a correction of 0.5 ACP is subtracted from the target azimuth to improve the estimate. Next, a correction is made to compensate for the round-trip signal propagation delay. The antenna scans at a rate of 13.0 RPM (actual timing of two ASR-9s), or 890.4 ACPs/sec. The time it takes for a signal to return from a target at the full 60 nm range is  $(60\text{nm} \cdot 2) \cdot (1852\text{m/nm}) / (3.0e8\text{m/s}) = 7.41e-4$  seconds, or 0.66 ACPs. To correct for both conditions, the following equation is used:

$$Az = Az - 0.5 + \left( (0.66) \left( \frac{R}{960} \right) \right) \quad (4)$$

where  $Az$  is in ACPs and  $R$  is in  $1/16^{\text{th}}$  nmi range gates. This differs slightly from the original ASP implementation, which approximated 0.66 as 0.75 and 960 as 1024 in the calculation due to lack of floating-point support.

#### 4.6.3 Doppler Interpolation and Smoothing

Each target contains a Doppler estimate for each PRF. These estimates are produced using a two-tiered approach. As each CPI of data is incorporated into a target, a Doppler estimate is produced by interpolating between the maximum filter magnitude and the magnitude of the adjacent filter (if present). This operation is performed during the target correlation phase to preclude the need to store all the filter information for each primitive. This operation is only performed for the data at the target's range centroid ( $R_c$ ). The intermediate value for each CPI is stored in the target. When the target correlation is completed, the interpolated Doppler values at each CPI are averaged together to produce the final smoothed Doppler value for each PRF.

Doppler values for each PRF are stored as integers that range from 0-63, where 0-32 represent positive Doppler quantities from zero out to the Nyquist interval, and 33-63 represent negative Doppler quantities from the Nyquist interval back to zero (63 is the smallest negative Doppler value). This Doppler scale is used for backward compatibility, and is the same as used in the final C&I output reports.

#### 4.6.3.1 Doppler Interpolation

At each CPI there may be multiple filter crossings, especially true when the target velocity lies somewhere between two of the filters. In such a case there will typically be two ‘adjacent’ filter crossings (e.g., +2 and +3), and the amplitude ratio of the two can be used to determine an improved estimate of the target Doppler. This is similar to the single PRF interpolation method used by the azimuth centroiding process. The interpolated Doppler value is given by:

$$\text{Dop} = \text{Dop}_{\text{avg}} + K_n (A_n - A_{(n-1)}) \quad (5)$$

$K_n$  is a table of interpolation constants for each pair of adjacent filters (see Appendix E),  $A_n$  and  $A_{(n-1)}$  are log magnitudes in 3/32 dB, and the Doppler values use the aforementioned 0-63 folded Nyquist scale. Note that if the amplitude difference is larger than the predicted maximum, this equation can result in a Doppler value that is outside the interval in question. To correct for this, the interpolated Doppler value is hard limited so that it never falls outside of the two-filter interval.

#### 4.6.3.2 Doppler Smoothing

The interpolated Doppler data from each CPI at the target's range centroid ( $R_c$ ) is averaged together to produce the final Doppler estimate for each PRF. To prevent outliers from being included in the average, a simple filtering step is performed that eliminates any Doppler values that are further than 12 Doppler ‘counts’ away from the Doppler value of the max amplitude filter (for each PRF) of the target.

#### 4.6.3.3 Resolving Unknown Doppler Cases

The Doppler Smoothing algorithm described above can fail to yield an answer, either because of a lack of data at a PRF, or because of a lack of data within 12 Doppler counts of the max amplitude filter Doppler value at a PRF. Single CPI targets, for example, have no data at one of the PRFs. For these targets, the interpolated Doppler value is set to 0.

In cases in which the outlier detection mechanism removes all data points (called unknown Doppler cases), an average cannot be computed. If a target has only one PRF with an unknown Doppler value, an interpolated Doppler value is chosen that would minimize the radial velocity computed using the interpolated Doppler value from the other PRF. Separate tables are pre-computed at startup to handle unknown low PRF and high PRF cases. The radial velocity calculation is discussed in more detail in the below.

Occasionally, the Doppler Smoothing algorithm yields unknown interpolated Doppler values for both PRFs. When this occurs, the PRF with the maximum amplitude return is selected, and the interpolated Doppler values used are the ones corresponding to the center radial velocity of the

maximum amplitude Doppler filter. At startup, tables are computed containing the interpolated Doppler values corresponding to the center radial velocities for each high PRF and low PRF Doppler filter class.

#### 4.6.3.4 Computing Radial Velocity

The radial velocity of a target can be estimated, given the radar transmit frequency, the low and high PRFs, and their respective interpolated Doppler values (calculated by the Doppler smoothing algorithm in the previous paragraphs). The 9PAC adaptive map thresholding algorithm (see section 5) uses radial velocity in some of its adaptive maps. In order to optimize CPU utilization, during system startup a table is constructed that provides the low and high PRF interpolated Doppler values (0-63) for every range rate value from -1000 to +1000 knots in 1 knot increments. The radial velocity computation for each target is replaced by a table lookup based on the target's interpolated Doppler values.

For a given radial velocity ( $v_r$ , the range rate in knots), the procedure for calculating the interpolated Doppler values for the high and low PRFs is as follows:

1. Compute the true Doppler frequency ( $f_d$ ). This formula is derived as follows:

A fundamental formula from radar text books [10] is:

$$f_d = 2 * v_r \div \lambda$$

where

$v_r$  is the radial velocity (m/s), and

$\lambda$  is the wavelength (m).

We also know that:

$$\lambda = c \div f_{XMIT}$$

where

$c$  is the speed of light, which is approximately  $3 * 10^8$  (m/s), and

$f_{XMIT}$  is the transmitted frequency (Hz).

Substituting for  $\lambda$ , we get:

$$f_d = (2 * v_r * f_{XMIT}) \div c$$

Since we started with range rate in knots, we need to convert our  $v_r$  to m/s, by multiplying by 1852, the approximate number of meters per nautical mile, and then we divide by 3600 seconds per hour.

$$f_d = (2 * v_r * f_{XMIT}) * (1852 \div 3600) \div c$$

The ASR-9 transmit frequency is between 2.7 and 2.9 GHz. Thus, we can simplify the large values of  $f_{XMIT}$  and  $c$  by removing  $10^8$  from both the numerator and denominator, which gives us:

$$f_d = (2 * v_r * f_{XMIT}) * (1852 \div 3600) \div 3$$

The final step is to note that, by convention, radial velocities for objects traveling away from the radar are considered positive, while velocities toward the radar are considered negative. Thus, we need to multiply by -1, as shown below:

$$f_d = -(2 * v_r * f_{XMIT}) * (1852 \div 3600) \div 3$$

2. Compute the measured Doppler frequency for each PRF ( $f_{LOW}$  and  $f_{HIGH}$ ).

This is done by adding or subtracting multiples of the PRF to/from  $f_{TRUE}$  until the frequency is between 0 and the PRF, as shown below. Note that that  $PRF_{LOW}$  and  $PRF_{HIGH}$  are the two low and high PRF VSPs, respectively.

```

fLOW = fd
while (fLOW > PRFLOW)
    do    fLOW = fLOW - PRFLOW
while (fLOW < 0)
    do    fLOW = fLOW + PRFLOW
fHIGH = fd
while (fHIGH > PRFHIGH)
    do    fHIGH = fHIGH - PRFHIGH
while (fHIGH < 0)
    do    fHIGH = fHIGH + PRFHIGH

```

3. Compute interpolated Doppler values for PRF based on the measured Doppler frequencies ( $f_{LOW}$  and  $f_{HIGH}$ ). Note that the interpolated Doppler values are rounded to the nearest integer value from 0 to 63.

$$D_{LOW} = (f_{LOW} * 64) \div PRF_{LOW}$$

$$D_{HIGH} = (f_{HIGH} * 64) \div PRF_{HIGH}$$

4. Interpolated Doppler values have an inherent error resulting from the interpolation and smoothing processes described in the previous section. Small changes in one of the interpolated Doppler values can result in a very different radial velocity when combined with the interpolated Doppler value from the other PRF. Therefore, the 9PAC radial velocity lookup table is constructed using an error budget of  $\pm 2$  interpolated Doppler values, as illustrated by the 5-by-5 matrix below. For a given low and high PRF interpolated Doppler pair ( $D_L, D_H$ ), the radial velocity table is set to the minimum absolute radial velocity value  $|v_r|$  for the all ( $D_L, D_H$ ) pairs in the 5-by-5 matrix defined by the error budget.

### High PRF Interpolated Doppler Value

Low PRF Interpolated Doppler Value	$D_L-2, D_H-2$	$D_L-2, D_H-1$	$D_L-2, D_H$	$D_L-2, D_H+1$	$D_L-2, D_H+2$
	$D_L-1, D_H-2$	$D_L-1, D_H-1$	$D_L-1, D_H$	$D_L-1, D_H+1$	$D_L-1, D_H+2$
	$D_L, D_H-2$	$D_L, D_H-1$	<b><math>D_L, D_H</math></b>	$D_L, D_H+1$	$D_L, D_H+2$
	$D_L+1, D_H-2$	$D_{L+1}, D_H-1$	$D_L+1, D_H$	$D_L+1, D_H+1$	$D_L+1, D_H+2$
	$D_L+2, D_H-2$	$D_{L+2}, D_H-1$	$D_L, D_H$	$D_L, D_H+1$	$D_L+2, D_H+2$

#### 4.7 TARGET REFORMATTING

Following the interpolation process, the radar targets are reformatted into the output report format. The format is similar to the ASP C&I output report format, but includes additional fields required by the 9PAC Tracker (see Appendix D). This report data structure is only used internally by 9PAC. Target report data is converted to a standard common digitizer (CD) format before it is output from the 9PAC to the MIP.

During the reformatting operation, the filter magnitudes for the high and low PRFs are normalized to account for the 10 vs. eight pulse integration in the front end as well as the small differences in attenuation of the various filters. In addition, the MTI flag is set for any report that is located within an MTI reflector range/azimuth region, defined in a VSP table (see Appendix A).

The reformatted reports are then output to the new geocensoring/adaptive thresholding process, described in Section 5.

#### 4.8 DELAY PROCESSING

Following the geocensoring/adaptive thresholding process and just prior to output to the Merge process, the targets are checked for boresight delay. As stated in Section 3, the allowable boresight delay in the non-Mode-S configuration is determined by the 9PAC Merge window, which is set to a minimum of 176 ACPs. Subtracting 24 ACPs to allow for communications latency between C&I and Merge (a generous amount – it will normally run from four to eight ACPs) results in an delay threshold of 152 ACPs. If more than four targets per scan exceed this threshold, a processing overload is assumed and range reduction occurs. Range reduction takes place in fixed size steps, which vary in size from 12 nmi at full range to 1 nmi at very short range. Table 4-1 shows the step sizes for all ranges. Assuming that the targets causing the delay are distributed fairly evenly over the current processing range interval, these step sizes result in a minimum load reduction of 20 percent at all ranges.

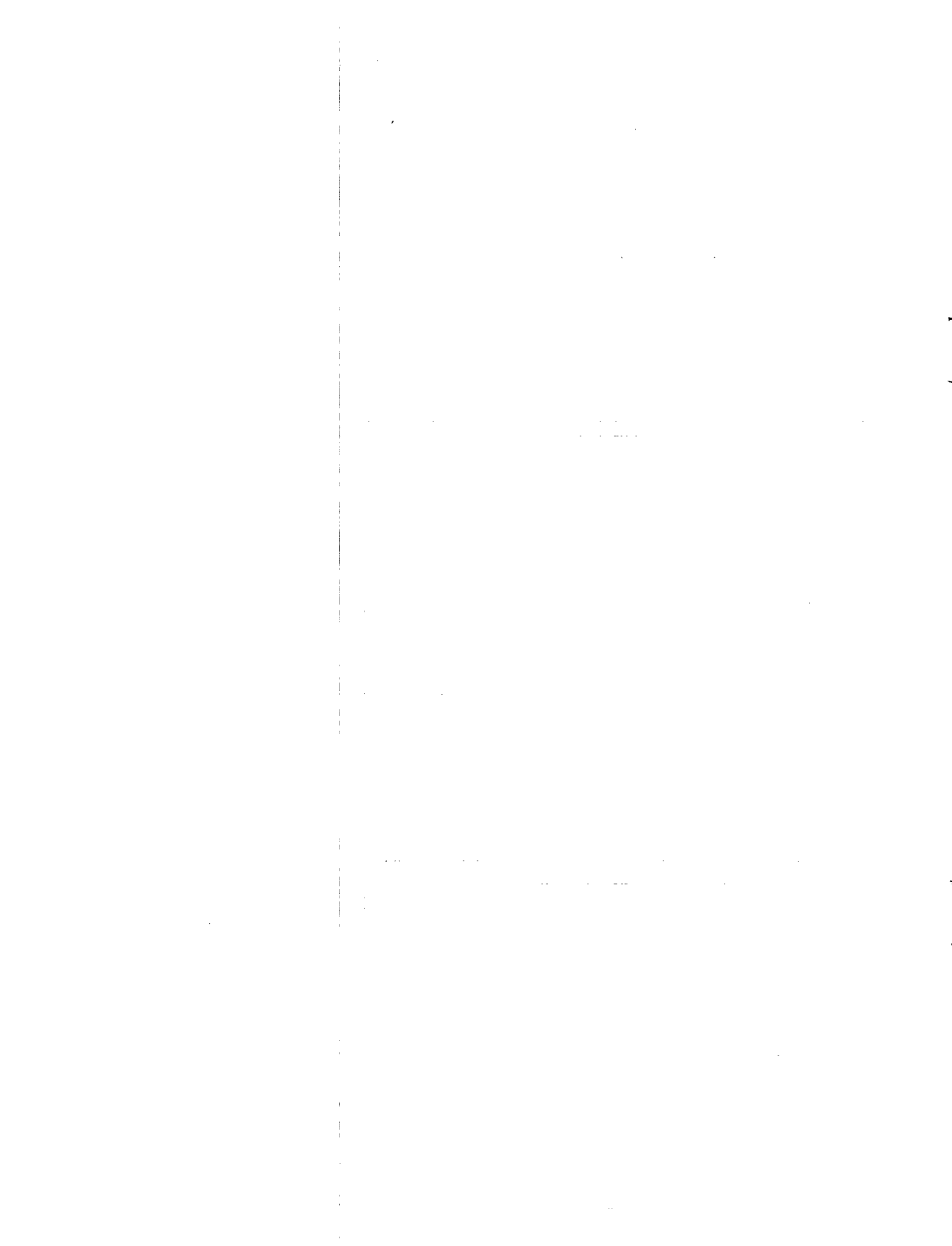

**Table 4-1. Range Reduction Step Sizes**

<b>Range (nmi)</b>	<b>Reduction Step Size (nmi)</b>
51-60	12
41-50	10
31-40	8
21-30	6
11-20	4
2-10	2

When the maximum boresight delay for all targets in a scan falls back below 136 ACPs, the processing range is allowed to recover back to the full 60 nmi range at a rate of 2 nmi/scan. The stricter requirement of 136 ACPs here instead of 152 prevents the processing range from continually 'hunting' when range reduction is in effect.

It should be noted that the capacity tests are designed to be sufficiently strenuous to ensure that range reduction never occurs under normal circumstances. It is most likely to be triggered by abnormal situations, such as inadvertent radar jamming or an STC malfunction in the ASR-9 front-end.



## 5. GEOCENSORING AND ADAPTIVE THRESHOLDING

### 5.1 OVERVIEW

Digital radar systems require post-signal-processing adaptive thresholding to eliminate unwanted “false” alarms that survive the CFAR thresholding process in the target extraction system. MTD systems such as the ASR-9 detect objects that appear to be moving with respect to the radar. Besides airplanes, other moving targets include ground vehicles, bird flocks, and weather fronts. Large fixed clutter returns can also appear to be moving because their Doppler signature is spread out by the rotation of the antenna. False alarms occur either because the radar returns have sharper reflectivity (i.e., larger amplitude) than the front-end range CFAR used for non-zero velocity Doppler filters, or because the false target sources are moving faster than the zero velocity filter CFAR’s reaction time.

ASR-9 false alarms fall into two basic classes. The first class consists of false targets caused by ground vehicles on visible sections of roads, large fixed clutter returns, and other features with localized geometry such as trains and windmills. These targets often have small spatial extents, and while they may exhibit a large amount of temporal variability, the geographic locations involved are fixed and cover a fairly small fraction of the radar surveillance space. In the 9PAC system these targets are removed using an adaptive geomap algorithm that has very high spatial resolution (i.e., small cells) and uses long observation times to identify regions where false alarms of this sort are likely to occur. The variation in what is visible to the radar over time is caused by changes in environmental conditions. This change in the bending of the radar pulses in the air is referred to as anomalous propagation, or “ducting.” The 9PAC geocensor algorithm adapts for anomalous propagation by creating or enabling geo cells. An amplitude threshold for each cell is maintained and used to discriminate between aircraft targets and clutter.

The second class of false alarms occupies a significant area and usually does not have fixed geographic locations. These false targets include bird flocks and weather returns. In some cases false ground clutter targets associated with anomalous propagation have sufficient spatial extent to fall into this class. Targets of this sort are best removed through the use of a time-area-Doppler amplitude CFAR system. This type of CFAR divides the radar coverage window into range-azimuth-Doppler cells, each of which maintains an adaptive amplitude threshold. Targets with amplitude below the threshold are deleted. The original MTD and the ASR-9 employ a relatively simple form of such a system. The multi-grid adaptive system described in this paper is designed to provide improved rejection of false targets and improved aircraft detection. These goals are accomplished by taking advantage of the additional computational and storage capability available in the 9PAC system.

Time-space CFAR algorithms have to contend with the conflicting requirements between the need for fast response vs. the desire to have as high a spatial resolution as possible. In general, as the cell size (in range-azimuth-Doppler space) decreases, a longer integration period is necessary to achieve an accurate threshold. Conversely, larger cells provide quicker reaction to change, but result in desensitization of an unnecessarily large fraction of the radar coverage area. In the 9PAC thresholding implementation, this issue is addressed by the use of multiple thresholding layers. The geocensor map has a very high resolution. Four additional adaptive

thresholding layers provide fine, medium, coarse, and very coarse resolution. This topology is illustrated in Figure 5-1.

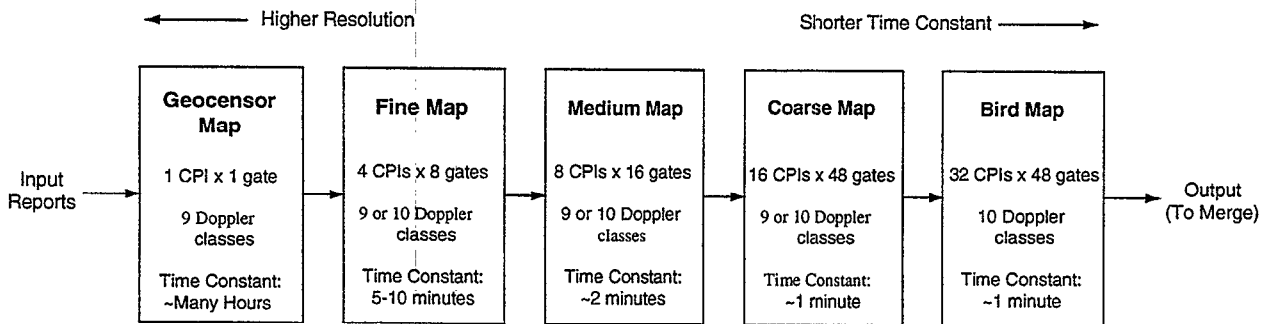

Figure 5-1. Multiple thresholding stages.

The fundamental units of detection of the ASR-9 are 960  $1/16^{\text{th}}$  nmi range gates and 512  $3/4^{\text{th}}$  degree CPI. The geomap has a resolution of 1 CPI x 1 range gate. Unlike the original hand-entered ASR-9 geomap, the adaptive geomap used by 9PAC provides independent amplitude thresholds in nine Doppler classes. For large fixed ground clutter, Doppler tends to be confined to filters near zero velocity. For ground vehicles, the Doppler return is dependent on the orientation of the road or train tracks with respect to the radar. For example, a road section that is oriented along a radial is likely to produce Doppler returns in every filter. However, a road that is oriented tangentially produces a limited Doppler spectrum. Providing separate geomap cells for each Doppler filter class improves detection by limiting the typically high-amplitude thresholds to only those Doppler filters that require them. The two Doppler filters corresponding to the highest unambiguous velocities (toward and away from the radar) of the high PRF are combined into a single class in order to save memory.

The Fine, Medium, Coarse, and Bird adaptive maps have polar cells of 4 CPI x 8 range gates, 8 CPI x 16 range gates, 16 CPI x 48 range gates, and 32 CPI x 48 range gates, respectively. The time constants are set by VSPs. Typical time constants would be several minutes for the Fine map, a couple of minutes for the Medium map, and one minute or less for the Coarse and Bird maps. Like the geocensor map, the adaptive maps maintain separate amplitude thresholds for different Doppler classes. Bird flocks and weather fronts tend to exhibit uniform Doppler characteristics. With the relatively large areas defined by the adaptive map cells, it is important to limit the amplitude thresholds to only those Doppler filters where a false alarm problem exists at a given time. The Fine, Medium, and Coarse map layers each consist of separate maps for single and multiple CPI targets; the single CPI target adaptive maps provide the same 9 Doppler filter classes as the geocensor map. The multiple CPI adaptive maps divide Doppler velocity into 10 radial velocity bins (Section 4.6.3.4 discusses the computation of radial velocity from the high and low PRF interpolated Doppler measurements). The Bird adaptive map layer does not provide a separate map for single CPI targets, and therefore has 10 radial velocity bins. Section 5.3 discusses the adaptive map layers in detail.

## 5.2 GEOCENSORING

The adaptive geomap processing is designed to detect and remove false radar targets that have small spatial extent and cover a relatively small fraction of the radar surveillance space. Such

false targets result from ground vehicles on visible sections of roads, large fixed ground clutter, and other features with localized geometry such as trains and windmills. The 9PAC algorithm represents a significant change from the original ASR-9 implementation, which used a static map calculated from observed target records and loaded by the person performing the initial site optimization. It is expected that the automation of this process will result in a significant reduction in the site setup and optimization time. It will also eliminate the need for human intervention when changes such as the construction of new roads occur.

Adaptive geocensoring also provides better performance than the hard-coded map, because it:

- provides four times as much spatial resolution as the original ASR-9 geomap; and
- adapts to the environment when the location of visible road traffic and ground clutter changes due to anomalous propagation or new road construction.

The spatial resolution of the geocensoring process is the fundamental radar resolution, 1 CPI x 1 range gate, which is twice the resolution of the original ASR-9 geomap in both range and azimuth. Furthermore, unlike the original ASR-9 geomap, the 9PAC adaptive geomap provides independent thresholds in nine Doppler classes. Higher resolution allows for the mapping of a smaller percentage of the overall radar cells for roads and should provide increased sensitivity to radar-only targets flying in close proximity to roads.

Adaptation is important because it allows the system to react to changing environmental conditions. Many ASR-9 sites have been visited more than once after initial site optimization because the geomap no longer provided adequate false alarm suppression. Because the hard-coded ASR-9 geomap is turned on all the time, geocensoring too much area inhibited aircraft detection. An adaptive geocensoring process is able to tailor its false alarm suppression to the current environment, including anomalous propagation with sufficient persistence. Thus, adaptation results in a reduction in false alarms in areas that would not have been part of the hard-coded ASR-9 geomap. Moreover, by using the adaptive geomap to remove false alarms resulting from anomalous propagation, the other adaptive thresholding maps that cover larger areas are able to run at lower amplitude thresholds, thereby improving aircraft detection in those larger areas.

The 9PAC adaptive geocensoring process can be broken into three components:

- geo cell identification and management (i.e., maintaining the geo map);
- threshold determination (i.e., setting amplitude thresholds);
- target censoring (i.e., identifying and removing false targets).

### **5.2.1 Geo Cell Identification and Management**

The 9PAC geocensor algorithm divides the radar coverage window out to 40 nmi range into a map of “geo cells”, each of which spans one azimuth CPI x one  $1/16^{\text{th}}$  nmi range gate x one Doppler filter class. Therefore, in the entire geo map, there are 2,949,120 cells (512 azimuth x 640 range x 9 Doppler). There are actually two separate geomaps, one for multiple-CPI targets and another for single-CPI targets, as will be discussed later. This brings the total number of

cells in the geomaps to 5,898,240! The 9 Doppler classes are: -3, -2, -1, -0, +0, +1, +2, +3, +/-4. The +4 and -4 Doppler filters are combined in order to save memory.

In practice, the vast majority of the numerous potential geo cells remain inactive throughout the life of the system. The basic method of determining which geo cells become “active” is to count radar target report density over long time periods. An active geo cell is defined as one that is allowed to flag or remove target reports. Time in the geocensor map is made up of “blocks”, each of which spans a 512-scan period (about 40 minutes). This interval is long enough to gather meaningful statistics for the small geo cells. It is also a convenient number from an implementation standpoint, because it matches the number of azimuth CPIs in the map, so that end-of-block bookkeeping (i.e., threshold adjustments, management of target density statistics) can be performed on 1 CPI per scan to distribute the processor load.

The 9PAC geocensoring process provides separate geocensor maps for multiple-CPI and single-CPI target reports. The rationale for this is that most aircraft targets are seen on more than one CPI, while many clutter returns are seen on only one CPI. A separate single-CPI geocensor map prevents high amplitude clutter returns from raising the amplitude thresholds of geo cells in the multiple-CPI map, where the vast majority of aircraft reports will be processed. This minimizes the area over which airplanes will be subjected to geocensoring.

### 5.2.1.1 Geo Cell Data Structure

Each geo cell maintains target report count statistics, an amplitude threshold, a total block count, an active block count, and a set of flags that control its behavior. The format of this 32-bit data structure is shown in Figure 5-2. The geo cell features shown in the figure are described briefly in the following list. A more detailed discussion will follow.

AF	AM	EF	PF	MF	DF	NF	Threshold (dB) 7-bits	Total Block Count 7-bits	Active Block Count 7-bits	FF	Report Count 3-bits
----	----	----	----	----	----	----	--------------------------	-----------------------------	------------------------------	----	------------------------

AF = Active Flag	MF = MTI Reflector Flag
AM = Airport Mask	DF = Deletion Flag
EF = Elephant Flag	NF = New Cell Flag
PR = Permanent Flag	FF = Fixed Geo Cell Flag

Figure 5-2. Geocensor cell data structure.

- The **report count** counts radar reports in the cell during a single 512-scan block;
- The **active block count** and **total block count** provide an M-out-of-N mechanism for measuring the percentage of blocks that receive a sufficient target density to qualify as active geo cells.
- The **threshold** is an amplitude threshold (dB) for the geo cell to be used in the target censoring process for active geo cells.
- The **active flag** (AF) indicates that a geo cell can be used in target censoring.

- A **fixed geo** cell has been input to the system by a human operator. A fixed geo cell is treated as a “permanent” permanent cell – it can never be deactivated unless the VSP table that specifies fixed geo cells is changed.

### 5.2.1.3 Geo Report Counting

The 9PAC adaptive geocensor map identifies geo cells by counting target report density over 512-scan blocks of time. Each cell in the geo map maintains a target density history for a maximum of 127 blocks. Each qualifying radar report (see below) is used to increment the target count in the corresponding geo map cell.

Since the goal is to determine the reflectivity of clutter, the 9PAC geo map attempts to eliminate target reports resulting from aircraft from the report counting process. Radar reports that merge with beacon reports are not counted; neither are most correlated radar reports. The following is a list of reports that are excluded from the report counting process:

- RTQC reports
- MTI reflector reports
- Reports resulting from interference (i.e., confidence 2)
- Reports beyond the maximum range of the geo map (i.e., 40 NMI)
- Reports that merge with beacon reports
- Correlated reports output by the Tracker without the “degrade” flag set
- Correlated reports with the “degrade” flag set and a corresponding track age > 20 scans.

The report qualification decision requires feedback from the radar/beacon Merge and Tracker. Therefore, the geo map report counting process is split between two tasks, which operate independently in the 9PAC system architecture. This design is shown in Figure 5-3. Many radar reports identified as clutter are deleted from the target report stream, either by the geocensor map or the adaptive threshold maps. Qualifying deleted reports are counted during the main C&I processing task. Reports that are output by the C&I to the Merge task might or might not be clutter and therefore cannot be counted until after the Merge and Tracker processing has been completed. This is implemented in the 9PAC software as a separate task from the main C&I processing task. The correlated and uncorrelated outputs of the Tracker are fed into this “C&I adaptive map update” task. Reports that do not meet one of the exclusion criteria listed above are deemed clutter and are used to increment the report count in the corresponding geo map cell.

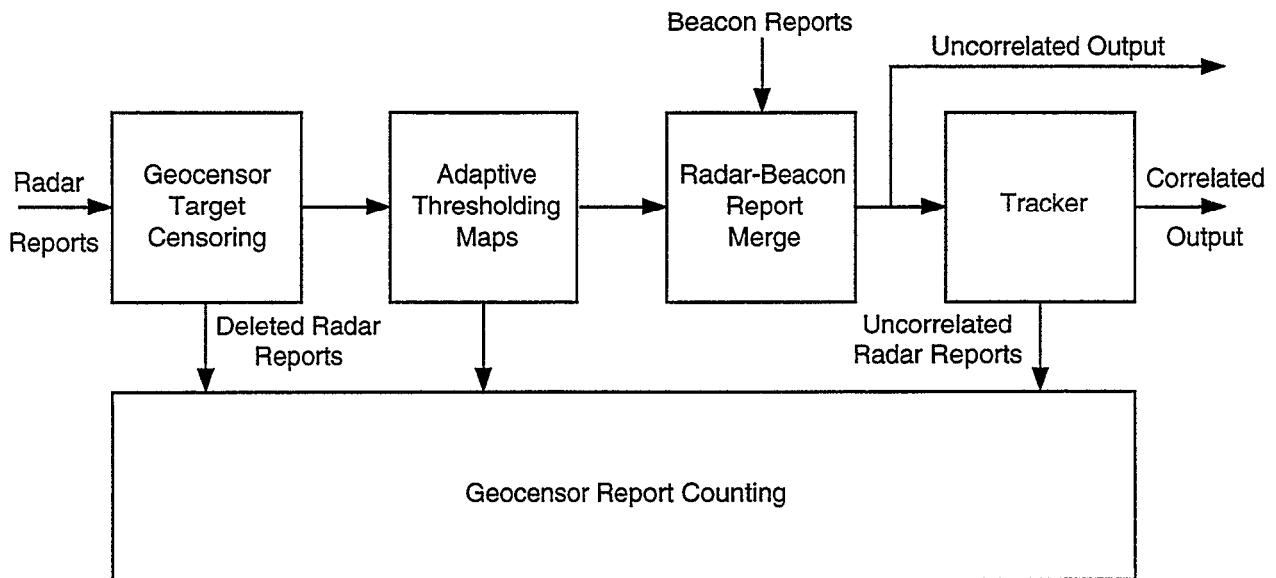

Figure 5-3. Geo report counting implementation.

There are a variety of bookkeeping issues in the report counting process, both in counting reports as they are received, and in maintaining the report density statistics at the end of a 512-scan block. At the end of each block, the total block count is incremented. The active block count is incremented if the target count for the completed block meets the active report count VSP (described in the next subsection). When the total block count reaches its maximum value (127), both the block counters are reset to 0. The target count is always reset to 0 at the end of a block.

#### 5.2.1.4 Geo Cell State Transitions

The behavior of a geo cell is determined by its type, which is based on its target report count history. This section presents the rules that govern the transitions between the geo cell types discussed earlier. These rules define the state transition diagram illustrated in Figure 5-4. Each geo cell is in one of the following states: non-geo, normal geo, active elephant, inactive elephant, or permanent.

##### 5.2.1.4.1 Non-Geo Cell State

All geo cells start in the non-geo state, and most will remain that way, since geo target activity is usually confined to certain geographical locations. A non-geo cell counts qualified target reports in its cell every block, and maintains the active block and total block counters. During a block, if the report count for the cell reaches the active report count VSP requirement, the cell becomes a normal (active) geo cell immediately. For the remainder of the block, a newly created normal geo cell is referred to as a “new” geo cell, and its “new cell flag” is set. A normal geo cell requires only a single active block. The active report count requirement is defined by a VSP that depends on the Doppler filter class of the cell and whether it is in the single-CPI or multiple-CPI geo map, as shown in Table 5-1.



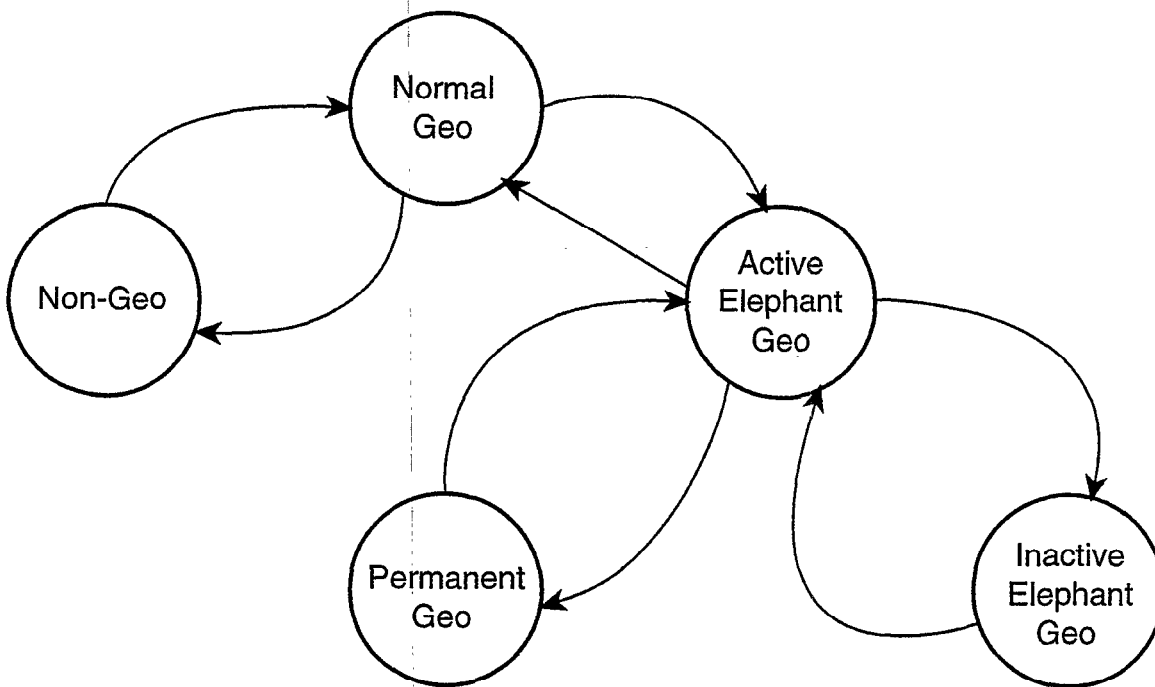

Figure 5-4. Geocensor cell state transition diagram.

At the end of each 512-scan block, the total block count for the cell is incremented. The active block count is incremented if the target report count for the block reached or exceeded the appropriate VSP from Table 5-1. This block counting process occurs for all cells in the geo map, regardless of the state of the cell. The usage of the total and active block counts is described in subsequent sections.

Table 5-1. Active Report Count VSPs

Which Map?	Doppler Filter Class	VSP to Use
Multiple-CPI	+/- 1	GEO_TGT_CNT_DOP1_MCPI
Multiple-CPI	+/- 0, +/- 2, +/- 3, +/- 4	GEO_TGT_CNT_DOP2_MCPI
Single-CPI	+/- 1	GEO_TGT_CNT_DOP1_SCPI
Single-CPI	+/- 0, +/- 2, +/- 3, +/- 4	GEO_TGT_CNT_DOP2_SCPI

#### 5.2.1.4.2 Normal Geo Cell State

A normal geo cell counts target reports just like a non-geo cell, resetting the target report count at the end of every block, and incrementing the total block count. The active block count is incremented only if the report count for the block reaches or exceeds the active block report count requirement (see Table 5-1). If a normal geo cell fails to maintain a minimum target report count (see Table 5-2) in the most recently completed block, it is demoted to a non-geo cell, and therefore it becomes inactive during target censoring.

**Table 5-2. Normal Geo Cell Minimum Report Count VSPs**

Which Map?	Doppler Filter Class	VSP to Use
Multiple-CPI	+/- 1	GEO_KILL_CNT_DOP1_MCPI
Multiple-CPI	+/- 0, +/- 2, +/- 3, +/- 4	GEO_KILL_CNT_DOP2_MCPI
Single-CPI	+/- 1	GEO_KILL_CNT_DOP1_SCPI
Single-CPI	+/- 0, +/- 2, +/- 3, +/- 4	GEO_KILL_CNT_DOP2_SCPI

A normal geo cell can be activated within a single block, and it can be turned off after a single block of inactivity. Thus, normal geo cells provide a mechanism for reacting quickly to environmental changes caused by anomalous propagation. However, deactivating geo cells quickly is not an efficient method of controlling false targets on roads. When a geo cell transitions between the normal geo and non-geo states, false targets on the road are allowed to enter the Tracker and probably cause false tracks. Thus, elephant and permanent geo cells are used to capture the many geo cells that exhibit persistent target density over longer periods of time.

The active block and total block counts for a geo cell provide a history of target report density. The transition from a normal geo cell to an elephant geo cell occurs if a minimum active block requirement is satisfied (see Table 5-3). If a normal geo cell has satisfied the active report count requirement (from Table 5-1) for M out of the last N blocks, then the cell is promoted to the active elephant geo state. When this occurs, the active block count and total block count for the cell are reset to zero.

#### 5.2.1.4.3 Active/Inactive Elephant Cell States

As long as an elephant geo cell remains active, it is used in the target censoring stage. An active elephant cell becomes inactive if its target report count for the most recent block is below the appropriate elephant deactivation report count VSP, as defined in Table 5-4.

Total block and active block counting continues for elephant geo cells, just as it does for all geo cells. When the appropriate total block count VSP from Table 5-3 is reached for an elephant geo cell, the total block count and active block count for the cell are reset to 0. The elephant cell must continually re-qualify using the appropriate M out of N block criteria. If at any time it is determined that it is no longer possible for the elephant cell to meet its qualification M out of N block criteria, the cell is immediately demoted to a normal geo cell, and its active and total block counts are reset to zero.

**Table 5-3. Elephant Geo Cell Block VSPs**

Which Map?	Doppler Filter Class	VSP Requirement
Multiple-CPI	+/- 1	GEO_EL_BLK_M_DOP1_MCPI active out of the last GEO_EL_BLK_M_DOP1_MCPI blocks
Multiple-CPI	+/- 0, +/- 2, +/- 3, +/- 4	GEO_EL_BLK_M_DOP2_MCPI active out of the last GEO_EL_BLK_M_DOP2_MCPI blocks
Single-CPI	+/- 1	GEO_EL_BLK_M_DOP1_SCPI active out of the last GEO_EL_BLK_M_DOP1_SCPI blocks
Single-CPI	+/- 0, +/- 2, +/- 3, +/- 4	GEO_EL_BLK_M_DOP2_SCPI active out of the last GEO_EL_BLK_M_DOP2_SCPI blocks

**Table 5-4. Elephant Geo Cell Deactivation VSPs**

Which Map?	Doppler Filter Class	VSP Report Requirement for 1 Block
Multiple-CPI	+/- 1	< GEO_EL_INACT_DOP1_MCPI reports
Multiple-CPI	+/- 0, +/- 2, +/- 3, +/- 4	< GEO_EL_INACT_DOP2_MCPI reports
Single-CPI	+/- 1	< GEO_EL_INACT_DOP1_SCPI reports
Single-CPI	+/- 0, +/- 2, +/- 3, +/- 4	< GEO_EL_INACT_DOP2_SCPI reports

An inactive elephant geo cell becomes active as soon as its target report count for a block reaches the appropriate elephant activation report count VSP, as defined in Table 5-5. Note that this can happen at any point during a block, thereby allowing elephant geo cells to become active quickly. In order to make elephant cells more effective than normal geo cells at controlling false alarms, elephant cells should be set up to activate on a single target report (i.e., set the VSPs in Table 5-5 to a value of 1).

**Table 5-5. Elephant Geo Cell Activation VSPs**

Which Map?	Doppler Filter Class	Activate when report count reaches:
Multiple-CPI	+/- 1	GEO_EL_ACT_DOP1_MCPI reports
Multiple-CPI	+/- 0, +/- 2, +/- 3, +/- 4	GEO_EL_ACT_DOP2_MCPI reports
Single-CPI	+/- 1	GEO_EL_ACT_DOP1_SCPI reports
Single-CPI	+/- 0, +/- 2, +/- 3, +/- 4	GEO_EL_ACT_DOP2_SCPI reports

#### 5.2.1.4.4 Permanent Cell State

An elephant geo cell is promoted to the permanent geo cell state if its ratio of active blocks to total blocks exceeds the appropriate permanent geo block percentage VSP (see Table 5-6). Conversely, a permanent geo cell is demoted to the elephant geo cell state if its block ratio drops below the block percentage VSP. A permanent geo cell is always active, and therefore is always used for the target censoring stage.

**Table 5-6. Permanent Geo Cell Block Percentage VSPs**

Which Map?	Doppler Filter Class	VSP to use:
Multiple-CPI	+/- 1	GEO_PERM_PCT_DOP1_MCPI
Multiple-CPI	+/- 0, +/- 2, +/- 3, +/- 4	GEO_PERM_PCT_DOP2_MCPI
Single-CPI	+/- 1	GEO_PERM_PCT_DOP1_SCPI
Single-CPI	+/- 0, +/- 2, +/- 3, +/- 4	GEO_PERM_PCT_DOP2_SCPI

#### 5.2.1.4.5 Fixed Geo Cells

Fixed geo cells are always called permanent, regardless of report density. A VSP table provides a mechanism for specifying up to 100 fixed geo cell regions, each of which can consist of multiple geo cells. For each region (see Table 5-7), the range and azimuth are specified in terms of start and extent; any or all of the 9 Doppler filter classes used by the geo map may be specified. A fixed geo cell region is always applied to both the single-CPI and multiple-CPI geo maps. The total number of regions to load from the table is specified as a separate VSP.

**Table 5-7. Fixed Geo Cell VSP Region**

Starting Range Gate (16 <sup>th</sup> NMI)	Range Extent Gates (16 <sup>th</sup> NMI)	Starting Azimuth CPIs	Azimuth Extent CPIs	Doppler Filters (Specified as a bit mask)
Value = 0..639	Value = 1..640	Value = 0..511	Value = 1..512	

## 5.2.2 Threshold Determination

Each range/azimuth/Doppler cell in the geocensor map maintains an amplitude threshold. The threshold is used during the geo target censoring phase to decide whether to output or delete target reports that occur within active geocensor cells (Section 5.2.3). The threshold is kept in integer decibel (dB) units.

The threshold for a geo cell is determined in a straightforward manner. Threshold determination consists of increasing the threshold based on observed target reports, and decreasing the threshold at regular intervals. During the report counting process (Section 5.2.1.3), the threshold is set to match the maximum amplitude of the qualifying target reports observed in the cell. In other words, if a qualifying target report appears in the geo cell with amplitude above the current threshold, the threshold is set to the amplitude of the report. For non-geo type cells, the

threshold is initialized when the first qualifying target report is observed during a 512-scan block.

At the end of each block, the threshold of a geo cell is decreased by a fixed amount that is set as a VSP (i.e., GEO\_DECR\_MCPI for the multiple-CPI geo map, or GEO\_DECR\_SCPI for the single-CPI geo map).

### **5.2.3 Target Censoring**

The purpose of the geocensor map is to identify areas of persistent ground clutter and vehicular traffic, and to inhibit the creation of false tracks in these areas. The target censoring phase of the geo processing accomplishes this task by subjecting target reports that occur in active geo cells to an amplitude threshold comparison. The result of the amplitude thresholding test is a decision as to whether to delete the report immediately or pass the report to the multi-grid adaptive thresholding maps (Section 5.3). Reports that are passed on to adaptive thresholding are given a radar confidence value that is used downstream by the Tracker to determine how to use these reports in track initiation and correlation.

The threshold comparison is performed for reports that occur in active geo cells. Multiple-CPI reports are compared with the corresponding multiple-CPI geo map amplitude threshold, and single-CPI reports are compared with the corresponding single-CPI geo map amplitude threshold. In order to be active for target censoring, a geo cell must be in one of the following states: normal; active elephant; permanent; or fixed.

#### **5.2.3.1 Exclusion from Target Censoring**

The following reports are excluded from the geocensor threshold comparison because they are not indicative of clutter or ground vehicular traffic:

- RTQC reports
- MTI reflector reports
- Reports resulting from interference (i.e., confidence 2)
- Reports beyond the maximum range of the geo map (i.e., 40 nmi)

These reports are passed through the target censoring process, without changing their radar confidence value.

There is a special exclusion category, called "velocity" exclusion, that is used to prevent reports that have a sufficiently fast radial velocity from being deleted by the geocensor map. Radial velocity is computed using the interpolated Doppler measurements from the high and low PRFs, as discussed in Section 4.6.3. Therefore, single-CPI (i.e., quality 0) reports are not eligible for velocity exclusion. A report that occurs in an active geo cell that qualifies for velocity exclusion is given a radar confidence value 0, and is not allowed to be deleted by the geocensor map or any of the multi-grid adaptive thresholding maps. A report qualifies for velocity exclusion if all of the following conditions are satisfied:

- The report quality is 1, 2, or 3;

- The report "degrade" flag is set to 0;
- The report is neither an RTQC nor MTI report;
- The report is within an active geo cell; and
- The computed radial velocity ‡ ID\_TEST\_VEL knots (a VSP).

### 5.2.3.2 Geocensor Threshold Comparison Tests

The target censoring process allows target reports with amplitude sufficiently above the geo cell threshold to be passed to adaptive thresholding with a radar confidence value of 1. The Tracker treats confidence 1 reports as more likely to be from aircraft than confidence 0 reports.

Not all reports are eligible for the confidence 1 label. Confidence 1 eligibility is a function of the type of geo cell and a VSP (GEO\_NEW\_CELL\_CONF1\_DISABLE). If the VSP is set to 1, then confidence 1 is not allowed for reports in a new geo cell (i.e., a normal cell that was transitioned from non-geo during the current block).

If eligible, the amplitude (A) of the report is compared with that amplitude threshold of the corresponding geocensor map cell. A report is given a confidence value of 1 if its amplitude is sufficiently above the geo cell's threshold (T). This confidence 1 threshold (T<sub>1</sub>) is defined as follows:

$$T_1 = T + \text{Bias},$$

where Bias is the geo threshold bias, defined by one of the VSPs in Table 5-8. There are three possible bias VSPs, one for new geo cells, one for multiple-CPI geo cells, and one for single-CPI geo cells.

**Table 5-8. Geocensor Map Threshold Comparison**

Which Map?	New Geo Cell?	Confidence 1 Requirement
Multiple-CPI	No	Report amplitude > (geo threshold + GEO_BIAS_MCPI)
Multiple-CPI	Yes	Report amplitude > (geo threshold + GEO_BIAS_NEW)
Single-CPI	No	Report amplitude > (geo threshold + GEO_BIAS_SCPI)
Single-CPI	Yes	Report amplitude > (geo threshold + GEO_BIAS_NEW)

Reports that are not eligible for the confidence 1 test, and reports that fail to satisfy the confidence 1 threshold requirement, are given confidence 0. A second threshold comparison test is used to determine whether to output or delete confidence 0 reports. Deletion of confidence 0 reports resulting from road traffic results in a lower false track rate in the correlated radar output stream of the 9PAC Tracker. The geocensor map deletes a confidence 0 report if either of the following conditions is satisfied:

- the deletion flag is set for the geo cell (see below); or
- the amplitude of the report (A) is sufficiently below the confidence 1 threshold (T<sub>1</sub>), as shown in the following relationship:

$$A < T_1 - T_D$$

where  $T_D$  is the deletion threshold offset, specified by one of the VSPs in Table 5-9.

**Table 5-9. Geocensor Deletion Threshold Offset VSPs**

Which Map?	Deletion Threshold Requirement
Multiple-CPI	Report amplitude < ( $T_1 - \text{GEO\_DEL\_THR\_MCPI}$ )
Single-CPI	Report amplitude < ( $T_1 - \text{GEO\_DEL\_THR\_SCPI}$ )

The geo deletion flag is set based on target report density. During the report counting process, the geo cell s deletion flag is set as soon as the geo cell s report count field reaches the appropriate deletion\_report\_count VSP (see Table 5-10). The deletion flag is cleared if the geo cell s report count for an entire block is less than the appropriate VSP.

**Table 5-10. Geocensor Deletion Report Count VSPs**

Which Map?	Which VSP to Use?
Multiple-CPI	GEO_DEL_CNT_MCPI
Single-CPI	GEO_DEL_CNT_SCPI

One undesirable side effect of allowing reports to be deleted by the geocensor map is a reduction of aircraft detection over roads. In order to minimize this problem, multiple-CPI reports that are marked for deletion are actually sent to the radar-beacon Merge function, so that a radar-beacon merge can occur. The Tracker function deletes a radar-only report output by the Merge if the "geo deletion" flag is set in the report. Therefore, multiple-CPI reports are not deleted from the uncorrelated radar-only output of the Merge; they are only deleted from the scan-to-scan radar report correlation function of the Tracker. However, single-CPI reports flagged for deletion are actually deleted before the Merge function.

### 5.3 MULTI-GRID ADAPTIVE THRESHOLDING

The 9PAC uses multiple levels of adaptive thresholding CFAR maps to handle false targets which occupy a relatively large area and are not predictably located. This category of false targets includes radar returns resulting from bird flocks and weather fronts, which tend to move through the radar coverage window. The 9PAC multi-grid adaptive maps are time-area-Doppler CFAR maps, which divide the radar coverage window into range-azimuth-Doppler cells, each of which maintains an adaptive amplitude threshold. Radar target reports are allowed to pass through such a map if their amplitude is above the amplitude threshold of the corresponding map cell, and are deleted otherwise.

The original ASR-9 C&I provided a single adaptive map layer with coarse cells. The 9PAC Phase II C&I adaptive map design consists of four layers of area CFAR maps, each with a different cell size. The 9PAC design provides the flexibility to react to a changing false target environment while maximizing aircraft detection.

First, we will discuss the adaptive map dimensions. Then, we will describe how the adaptive amplitude thresholds work.

### 5.3.1 Adaptive Map Dimensions

Cell size is a key parameter in the design of area CFAR maps. Clearly, a cell with a larger area observes more targets than a cell with a smaller area. This allows a larger cell to react more quickly to emerging false targets by raising the amplitude threshold appropriately. On the other hand, larger cells have the disadvantage of desensitizing a larger area of the radar coverage region than may be necessary for a particular instance of false targets. This trade-off between reaction time and resolution was introduced at the beginning of this chapter in Figure 5-1.

Figure 5-5 illustrates the multi-grid adaptive map thresholding stages, which consist of four layers of three-dimensional (range/azimuth/Doppler) area CFAR maps, each with different dimensions. The Fine Map provides the smallest cells, and therefore the highest resolution (except for the geocensor map discussed in section 5.2), and the slowest reaction time. The Medium Map, Coarse Map, and Bird Map have increasingly larger cell sizes, and therefore lower resolution and faster reaction times. Reaction time can also be thought of in terms of a time constant, which indicates how quickly a map can recover sensitivity when false targets are not present in a cell. A larger cell can recover more quickly, because it has a better chance at observing false targets if they are present.

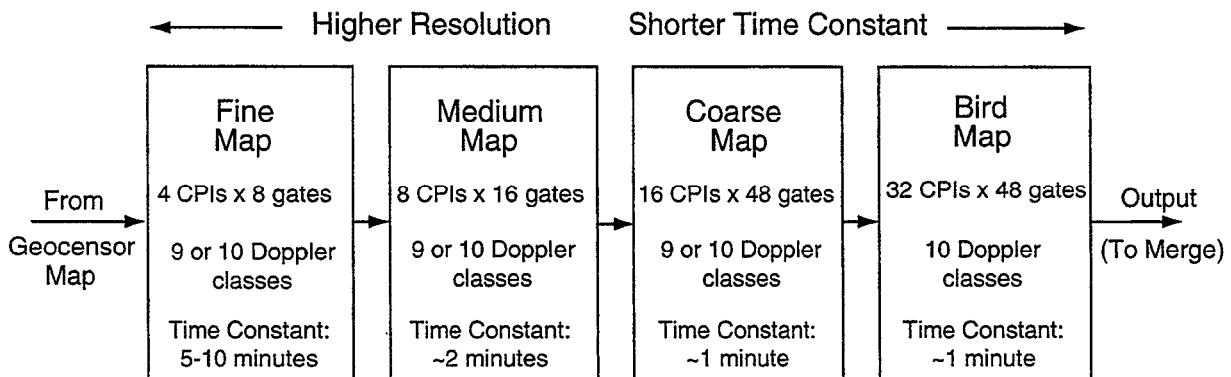

Figure 5-5. 9PAC adaptive map thresholding stages.

The Fine, Medium, and Coarse maps each consist of two separate maps, one for multiple-CPI targets, and the other for single-CPI targets. Separate maps are used for single-CPI targets because most aircraft returns are large enough to occupy multiple-CPI, while the majority of false targets occupy only a single-CPI. By preventing single-CPI targets from causing an increasing the amplitude threshold of cells in the multiple-CPI map, the probability of detection is increased for most aircraft. The Bird Map layer, which is used to combat false targets resulting from wide-area bird migration, has a single map for all reports. The map dimensions and cell sizes are listed in Table 5-11. All 9PAC adaptive map layers cover the full 60 nmi range window.



**Table 5-11. Adaptive Map Cell Sizes**

Which Map?	Map Dimensions	Azimuth Cell Size	Range Cell Size
Fine Multiple-CPI	128 azimuth x 121 range x 10 radial velocity	4 CPI	0.5 NMI
Fine Single-CPI	128 azimuth x 121 range x 9 Doppler filter classes	4 CPI	0.5 NMI
Medium Multiple-CPI	64 azimuth x 61 range x 10 radial velocity	8 CPI	1 NMI
Medium Single-CPI	64 azimuth x 61 range x 9 Doppler filter classes	8 CPI	1 NMI
Coarse Multiple-CPI	32 azimuth x 31 range x 10 radial velocity	16 CPI	3 NMI
Coarse Single-CPI	32 azimuth x 31 range x 9 Doppler filter classes	16 CPI	3 NMI
Bird	16 azimuth x 31 range x 10 radial velocity	32 CPI	3 NMI

The Doppler dimension of the adaptive maps provides a mechanism for detecting aircraft traveling in an area where false targets are present at a different radial velocity than the aircraft. The 9PAC uses different methods for defining the Doppler dimension for its multiple-CPI and single-CPI adaptive maps. For the single-CPI adaptive maps, the 9PAC uses the same 9 Doppler filter classes used for the adaptive geocensor map. Recall (from Section 4.6.3) that the maximum amplitude Doppler filter class is determined for both the high and low PRF. This method of defining the Doppler dimension was also used in the original ASR-9 adaptive map design.

For the 9PAC Phase II multiple-CPI adaptive maps, however, a different definition of Doppler velocity is used. Radial velocity is computed for each target based on the interpolated Doppler measurements made during the Doppler interpolation process (see Section 4.6.3). The multiple-CPI adaptive maps provide 10 radial velocity bins for each range/azimuth area. Each radial velocity bin provides 16 knots of radial velocity resolution. Thus, these adaptive maps cover radial velocities between -80 and +80 knots. Generally speaking, radar reports with a radial velocity that exceeds these boundaries are considered to be aircraft and are therefore not subjected to adaptive thresholding. This will be discussed later on.

The 9PAC adaptive map processing can be broken into the following components, each of which is discussed in the following sections:

- **Threshold Comparison and Increment:** Comparing target report amplitudes against the adaptive map amplitude thresholds and increasing the thresholds when necessary;
- **Threshold Decrement:** Decreasing the adaptive map amplitude thresholds on a regular basis to recover radar sensitivity;

- **Bird Map Activation and Deactivation:** Determining when to use the Bird Map layer to handle unusual false target densities resulting from bird migration; and
- **Threshold Corrections:** Decreasing the clutter amplitude thresholds in order to reverse the effect of having increased the threshold for a radar report that was merged with a beacon report or was correlated by the 9PAC Tracker.

### 5.3.2 Adaptive Map Threshold Comparison and Increment

The main function of the adaptive thresholding maps is to separate the radar targets that represent aircraft (i.e., the signal) from those that do not represent aircraft (i.e., the clutter). The adaptive map threshold comparison process accomplishes this by submitting qualifying target reports to multiple stages of filtering using the four 9PAC adaptive CFAR maps, in order of increasing cell size. A high-level illustration of this process is shown in Figure 5-6.

The Fine, Medium, and Coarse maps delete reports with amplitude less than the amplitude threshold of the corresponding map cell. A report that is deleted by the Fine Map is flagged for deletion, and is not passed to the Medium and Coarse Maps. Likewise, a report that is flagged for deletion by the Medium Map is not passed to the Coarse Map. The Bird map operates differently than the others. All reports eligible for adaptive thresholding are passed to the Bird map, even if they are deleted by one of the earlier maps. The reason for this will be discussed below. The Bird Map flags but never deletes reports with amplitude below the corresponding threshold. Reports deleted by the Fine, Medium, or Coarse Maps are removed from the output report stream.

The adaptive map amplitude thresholds are increased when the amplitude of a qualified report exceeds the amplitude threshold of the corresponding cell. Note that the adaptive map thresholds are incremented "on-the-fly" before the radar-beacon merge and tracking processes occur. The FAA requested this feature, which is also part of the original ASR-9 adaptive map design. It has the disadvantage of allowing the thresholds to rise based on radar reports from aircraft. The 9PAC design uses feedback from the Merge and Tracker tasks to correct this problem. This is discussed in more detail below.

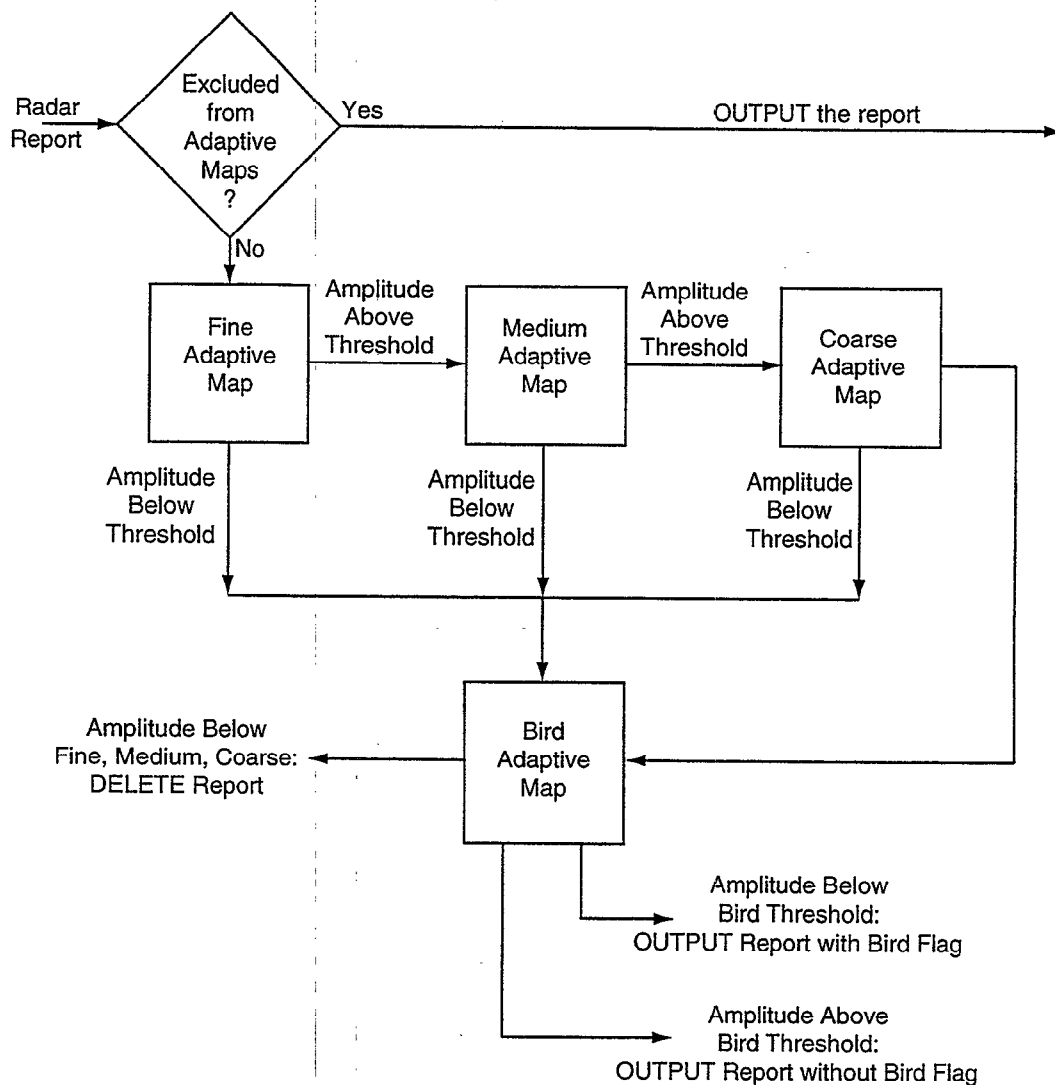

Figure 5-6. Adaptive map threshold comparison block diagram.

At each adaptive map thresholding stage, multiple-CPI reports are compared against the multiple-CPI map amplitude threshold that corresponds to the range/azimuth/Doppler of the report. Single-CPI reports are subjected to both the multiple-CPI and single-CPI map thresholds, either or which can delete these reports. In order to be compared against the multiple-CPI adaptive maps, which have Doppler cells based on radial velocity, a single-CPI report selects a velocity bin based on its Doppler filter, as shown in Table 5-12.

**Table 5-12. Single-CPI Report Doppler Filter to Radial Velocity Conversion**

Doppler Filter	Radial Velocity Bin
-3	49..64 knots
-2	33..48 knots
-1	17..32 knots
-0	0-16 knots
+0	-15..-1 knots
+1	-31..-16 knots
+2	-47..-32 knots
+3	-64..-48 knots
+4	-64..-48 knots
-4	49..64 knots

The next section discusses which reports are excluded from the adaptive map threshold comparison, and which reports are disallowed from raising the adaptive map amplitude thresholds. The sections that follow describe the comparison and increment algorithm in more detail for each adaptive map layer.

### **5.3.2.1 Exclusion from Adaptive Thresholding**

Certain types of radar target reports are excluded from the adaptive map thresholding comparison, and are not allowed to cause the map threshold values to be increased. (See Figure 5-7.) These targets include the following:

- RTQC test targets and MTI reflector test targets;
- Targets with a fast radial velocity; and
- Targets with large amplitude (i.e., large radar cross section).

Other target reports are compared against the adaptive map thresholds, but are not allowed to cause the threshold values to be incremented. These targets include the following:

- Targets from geocensor map cells (i.e., confidence 0 or 1);
- RFI (interference) targets (i.e., confidence 2).

The velocity and amplitude exclusion tests are used to identify reports that are statistically most likely to correspond to aircraft targets. These tests are summarized in the following paragraphs.

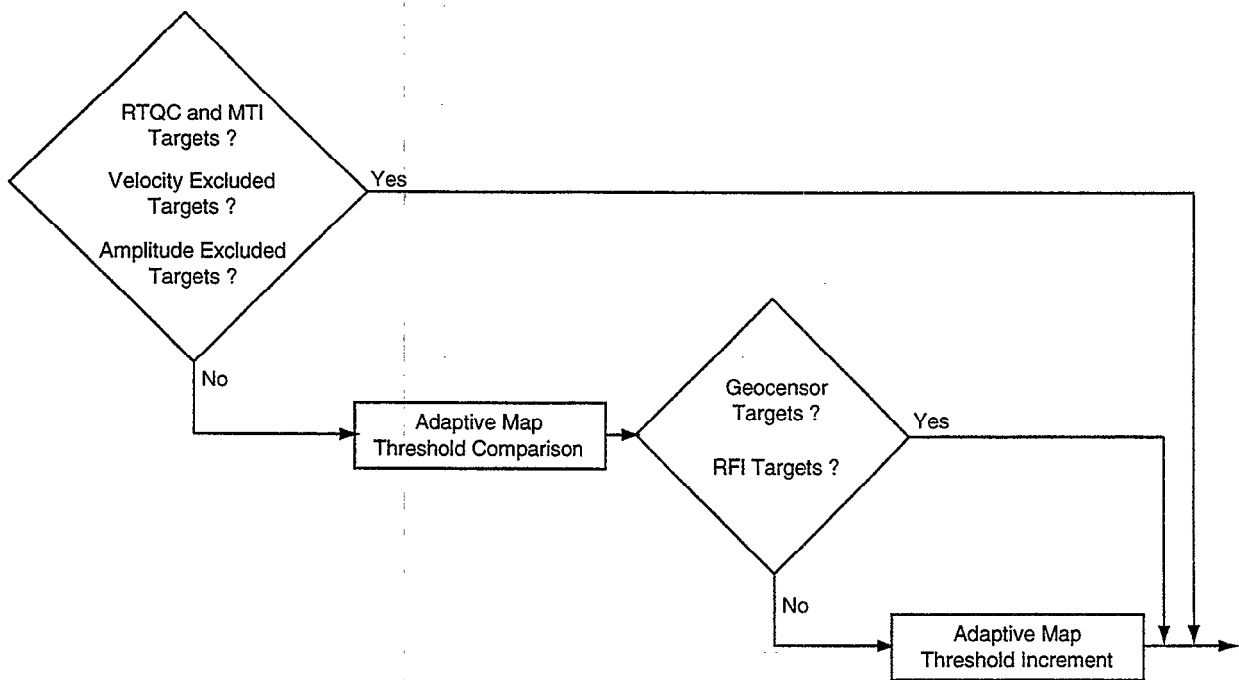

Figure 5-7. Exclusion from adaptive map processing.

### ***Velocity Exclusion***

The purpose of velocity exclusion is to prevent aircraft from being subjected to the adaptive map thresholding process. It is assumed that only aircraft can fly above a certain radial velocity. The velocity exclusion test is only applied to multiple-CPI reports, because interpolated Doppler values are required from both PRFs in order to compute radial velocity. If the radial velocity of the target is at or above a VSP (ID\_TEST\_VEL), the target is excluded from adaptive thresholding.

The radar confidence assigned to the target depends on its Doppler filter. If the maximum amplitude Doppler filter of the target is in the zero velocity range (+0 or -0), the report is assigned confidence 4. Otherwise, the report is assigned confidence 6. The 9PAC Tracker function considers confidence 6 to be an excellent indicator of an aircraft for primary radar reports.

### ***Amplitude Exclusion***

The purpose of amplitude exclusion is to prevent the amplitude thresholds of adaptive map cells from rising too high. This capability is provided in case the normal adaptive thresholding mechanism failed to handle a site-specific situation, but its use is not anticipated. The problem with amplitude exclusion is that it allows large clutter targets to be labeled with the highest confidence value, which results in an increase in false tracks. A similar capability existed in the original ASR-9 ASP-based C&I. There are two types of amplitude exclusion in the 9PAC Phase II system: range/Doppler amplitude exclusion; and adaptive map cell amplitude exclusion. Single-CPI targets are not eligible for amplitude exclusion. If a multiple-CPI report satisfies the conditions for amplitude exclusion, its confidence is set based on its maximum amplitude

Doppler filter. If the Doppler filter is in the zero velocity filter range (+0 or -0), the report confidence is set to 4. Otherwise, the report confidence is set to 6.

Range/Doppler amplitude exclusion provides a VSP table that allows maximum amplitude values to be specified for 3 Doppler filter x 15 range bands. Reports with amplitude above the appropriate value specified in the table are excluded from the adaptive map thresholding process. The VSP table provides separate amplitude limits for +/- 0, +/- 1, and all other Doppler filters for the following 15 range bands, as shown in Table 5-13.

**Table 5-13. Adaptive Map Amplitude Exclusion VSP**

		Range (NMI)														
Dop	< 3	3-6	6-9	9-12	12-15	15-18	18-21	21-24	24-27	27-30	30-36	36-42	42-48	48-54	54-60	
±0	95	95	95	95	95	95	95	95	95	95	95	95	95	55	55	
±1	95	95	95	95	95	95	95	95	95	95	95	95	95	55	55	
Other	95	95	95	95	95	95	95	95	95	95	95	95	95	95	55	

Adaptive Map Cell amplitude exclusion provides a VSP table that allows maximum amplitude values to be specified for contiguous range/azimuth/Doppler cells in the Fine adaptive thresholding map. For a selected Fine Map range/azimuth region, separate amplitude limits are specified for the following radial velocity bins: 0 to 16 knots and -15 to -1 knots; 17 to 32 knots and -31 to -16 knots; 33 to 48 knots and -47 to -32 knots; and 49 to 80 knots and -80 to -48 knots. These radial velocity bins correspond to the Doppler cells in the multiple-CPI adaptive maps. A report is excluded from the adaptive map thresholding if it falls within a Fine map cell specified in the VSP table, and the amplitude of the report is above the amplitude value specified in the table.

### 5.3.2.2 Fine, Medium, and Coarse Map Threshold Comparison and Increment

The adaptive map comparison and increment algorithm is the same for the Fine, Medium, and Coarse adaptive maps. The algorithm steps are slightly different for multiple-CPI and single-CPI reports. Figure 5-8 shows a flow chart of the multiple-CPI report processing algorithm steps. The first step is to select the appropriate adaptive map cell, based on the range, azimuth, and Doppler of the report. The report amplitude is compared against the cell's amplitude threshold. If the report amplitude is at or below the threshold, the report is flagged for deletion. If the report amplitude is above the threshold, the report is eventually passed to the next map layer, if any. If a report that passes the threshold test has a confidence value of 3, 4, or 5, then the amplitude threshold of the corresponding adaptive map cell is increased by an amount specified as a VSP (FINE\_BUMP, MEDIUM\_BUMP, or COARSE\_BUMP).

Figure 5-9 shows a flow chart of the single-CPI report processing algorithm steps. A single-CPI report is first subjected to the multiple-CPI threshold test. If the report amplitude is above the corresponding multiple-CPI adaptive map threshold, the report is then subjected to the single-CPI adaptive map threshold test. If the report amplitude is at or below the threshold of either the multiple or single-CPI adaptive map threshold, the report is flagged for deletion. In order to be

passed to the next adaptive map layer, the report amplitude must be greater than both the multiple-CPI and single-CPI map amplitude thresholds. If a report that passes both of the threshold tests has a confidence value of 3, 4, or 5, then the single-CPI map threshold is increased by an amount specified as a VSP (FINE\_BUMP\_1CPI, MEDIUM\_BUMP\_1CPI, or COARSE\_BUMP\_1CPI).

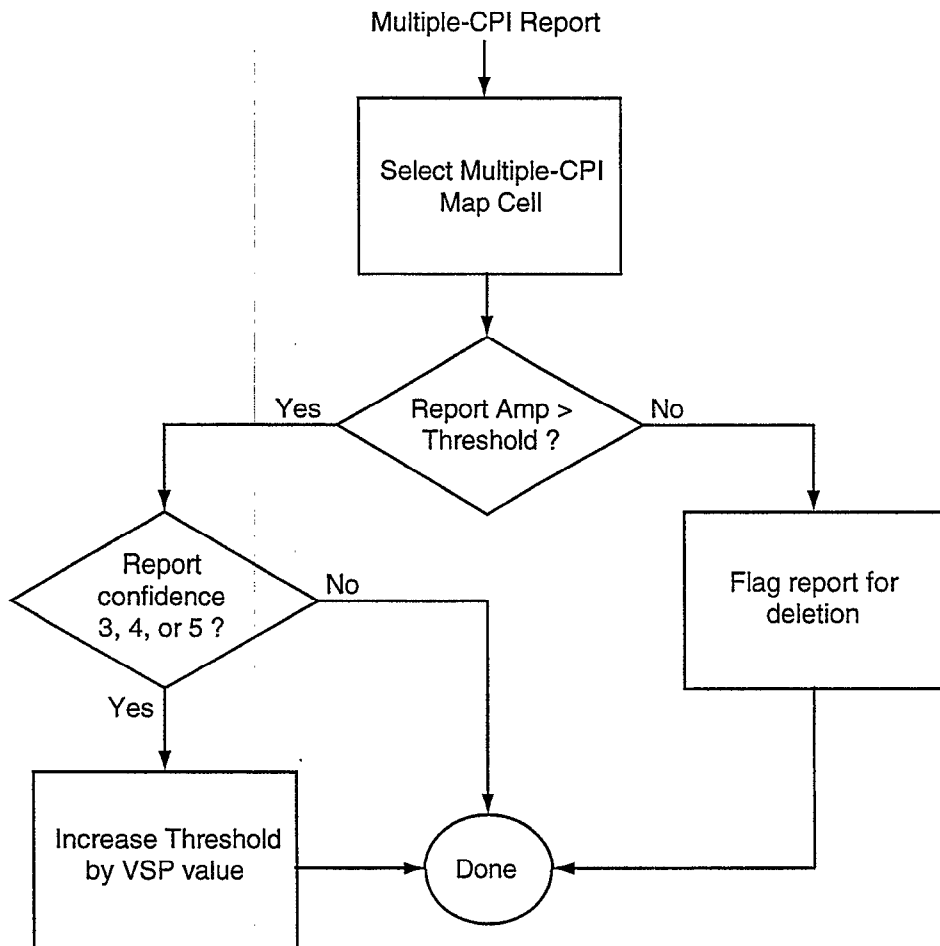

Figure 5-8. Fine/Medium/Coarse adaptive map comparison logic for multiple-CPI reports.

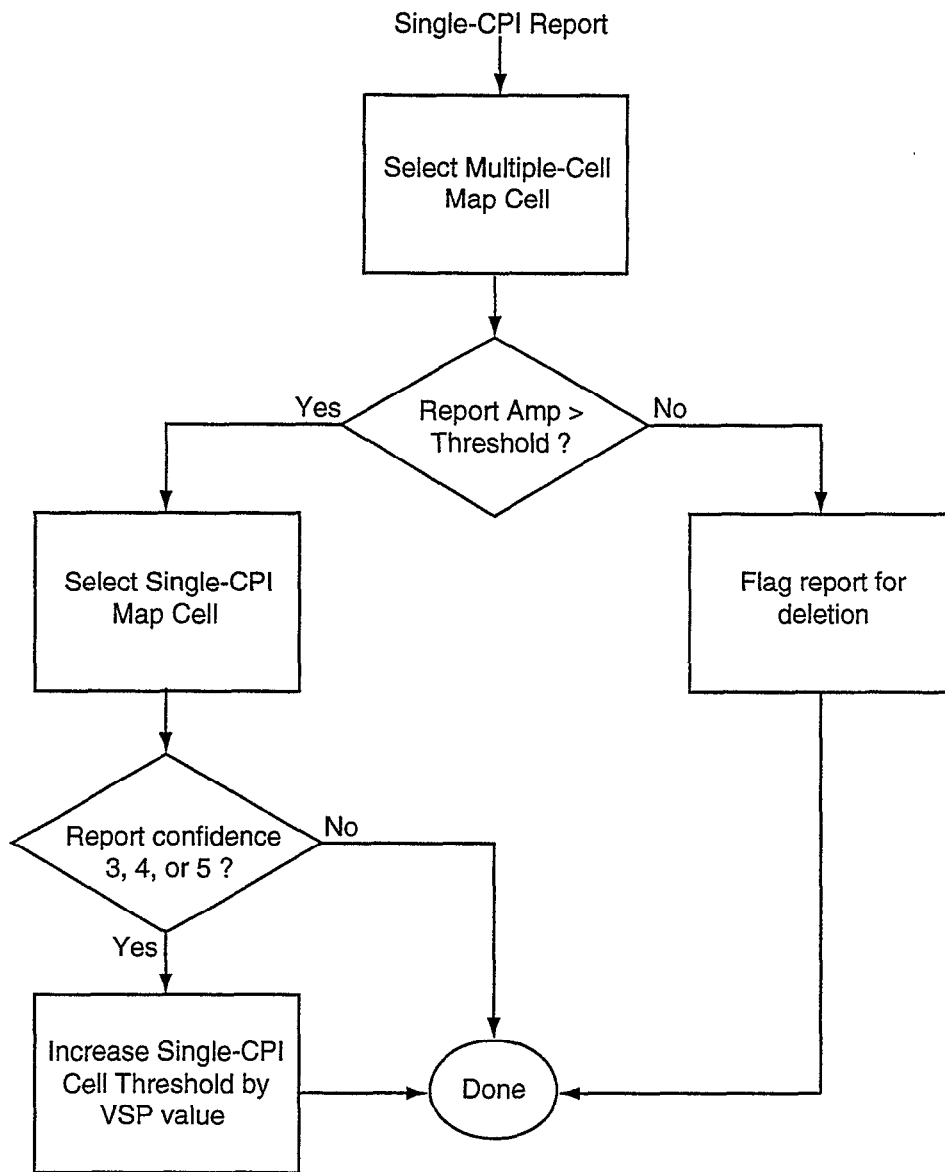

Figure 5-9. Fine/Medium/Coarse adaptive map comparison logic for single-CPI reports.

### 5.3.2.3 Bird Map Threshold Comparison and Increment

The Bird Map is the final adaptive thresholding stage, and it provides the cells with the largest area. The Bird Map operates differently than the other adaptive maps. The Fine/Medium/Coarse Maps are always active, and can delete reports. The Bird Map, on the other hand, is not always active, and flags reports instead of deleting them. Every report eligible for adaptive thresholding is passed to the Bird Map, regardless of the outcome of the Fine/Medium/Coarse Map processing. This means that reports that were deleted by the Fine/Medium/Coarse maps are allowed to raise the Bird Map thresholds. This allows the Bird Map to operate with a more aggressive threshold than the other adaptive maps. It needs the aggressive threshold in order to handle bird migration over large areas.



Figure 5-10 illustrates the Bird Map threshold comparison logic. A multiple-CPI report with an appropriate confidence value and whose amplitude exceeds the corresponding Bird Map amplitude threshold causes the threshold to be increased by an amount specified by the VSP BIRD\_BUMP. A report (single or multiple-CPI) whose amplitude is at or below the corresponding Bird Map threshold is flagged if the Bird Map is currently active and if the report was not deleted by either the Fine, Medium, or Coarse map. The Bird Map is only activated when necessary. The algorithm for activating and deactivating the Bird Map is described in Section 5.3.4.

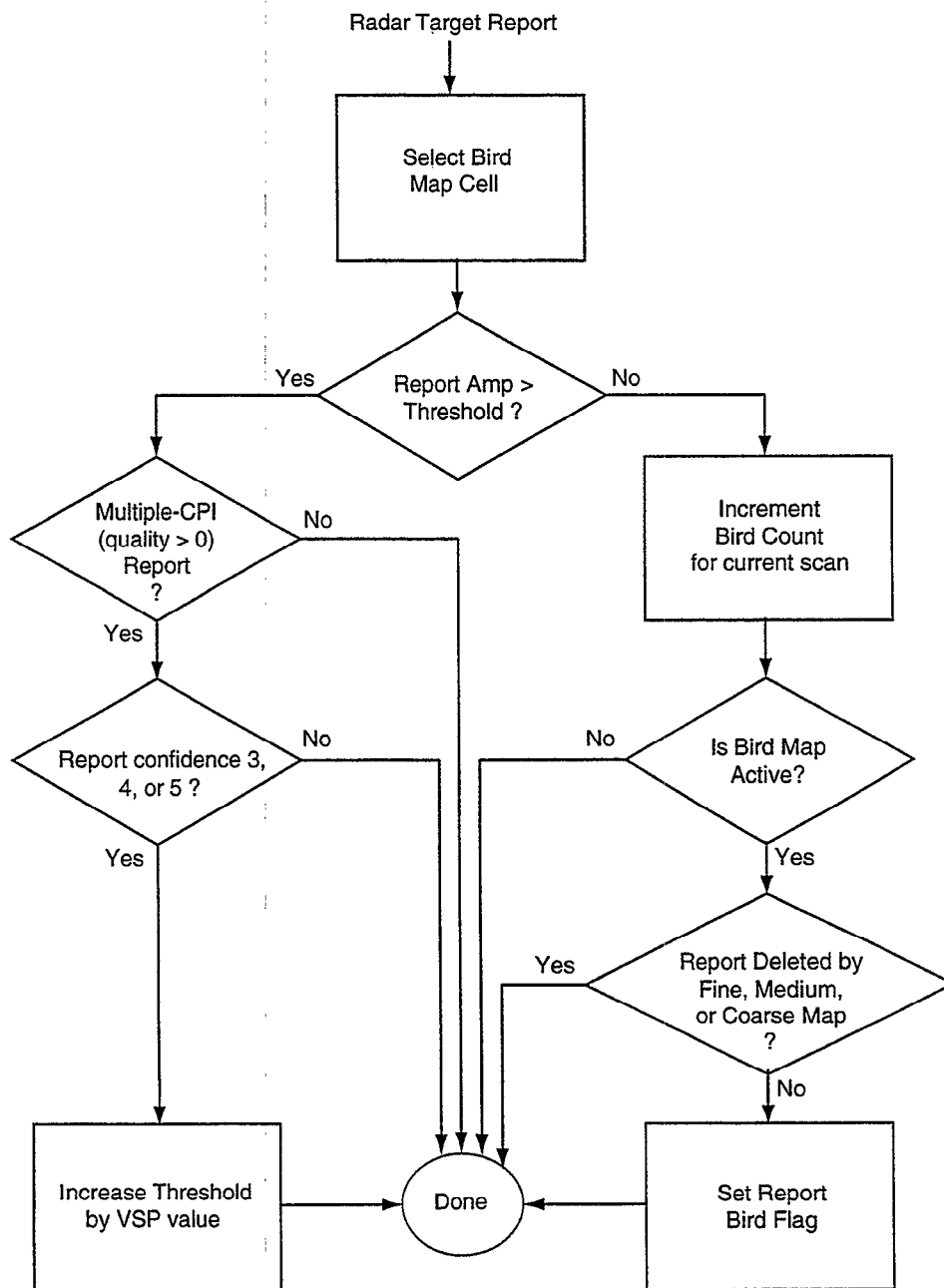

Figure 5-10. Bird adaptive map comparison logic.

### 5.3.3 Adaptive Map Threshold Decrement

In order to maintain a constant false alarm rate, each adaptive map cell threshold value must be decreased at regular intervals in order to reclaim sensitivity when target reports are not present to raise the threshold. The decrement time for each adaptive map, specified by a VSP, indicates the number of scans it takes to lower the threshold by the amount of the threshold increase caused by a single target report during the map comparison test (see Section 5.3.2). Thus, the actual amount the threshold is decreased each scan can be expressed as follows:

$$d = \text{Increment VSP} / \text{Decrement Time VSP}$$

For example, if the threshold increment VSP is set to 3 dB, and the decrement VSP is set to 10 scans, this means that the decrement value for each scan would be 3 divided by 10, or 0.3 dB. In this example, it would take 10 scans to reduce the threshold by 3 dB.

By using site adjustable parameters, the 9PAC adaptive map provides a very flexible system that can be tuned if necessary for a site-specific problem. The decrement time VSP value plays a critical role in determining the probability of detection and false alarms output by the radar.

In general, there is a relationship between the size of the cell and the size of the decrement. The Bird Map, with the largest cell size, would have the largest (i.e., fastest) decrement value, and therefore has a decrement time VSP with a small value. A smaller cell size ideally requires a smaller decrement value, and therefore a larger decrement time VSP value.

The following paragraphs describe the decrement algorithm for the various adaptive map layers. The Fine and Medium maps are described in one section, because the decrement procedure for this maps is very similar. The Coarse and Bird maps are discussed separately, because additional factors allow the decrement values to change over time.

#### 5.3.3.1 Fine and Medium Map Threshold Decrement

Conceptually, the adaptive map threshold decrement value for the Fine and Medium maps is computed using the simple formula shown above. However, it is not practical from an implementation standpoint to perform this calculation for every range/azimuth/Doppler cell in the Fine and Medium maps once per scan. Therefore, in the software, the decrement is performed when the cell is being used in the adaptive map threshold comparison process. Before the comparison is made, the amplitude threshold of the appropriate Fine or Medium Map cell is decreased based on the amount of time that has elapsed since the cell was last updated. This calculation is shown below:

$$T = T - (d * N)$$

where T is the amplitude threshold of the cell,

d is the one-scan decrement value (computed above), and

N is the number of scans since the last time the cell's threshold was updated.

All Fine and Medium Map cells are updated periodically, on a rotating basis, in order to set each cell's amplitude threshold to a value that accounts for the time that has elapsed since the last target report observed in the cell. This is done in order to allow amplitude threshold data to be

extracted on a regular basis for real-time system monitoring and offline analysis. For the Fine Map, each cell is updated once every 32 scans. For the Medium Map, each cell is updated once every 16 scans.

The decrement times for the Fine and Medium maps are specified by VSPs, as shown in Table 5-14.

**Table 5-14. Fine and Medium Adaptive Map Threshold Decrement VSPs**

Which Map?	Threshold Decrement Time VSP (scans)
Multiple-CPI Fine Map	FINE_TIME_MCPI
Single-CPI Fine Map	FINE_TIME_SCPI
Multiple-CPI Medium Map	MEDIUM_TIME_MCPI
Single-CPI Medium Map	MEDIUM_TIME_SCPI

### 5.3.3.2 Coarse Map Threshold Decrement

The Coarse map consists of relatively few range/azimuth/Doppler cells. Thus, each cell in the Coarse map is updated near the beginning of each scan based on the activity in the cell on the previous scan. Unlike the Fine and Medium maps, however, the Coarse map decrement value can vary from scan to scan. Also, the multiple-CPI and single-CPI Coarse maps use slightly different algorithms for determining the decrement value.

### 5.3.3.3 Multiple-CPI Coarse Map Threshold Decrement

The decrement value for a multiple-CPI Coarse map cell depends on the following factors:

- (a) two VSPs, COARSE\_TIME\_MIN\_MCPI and COARSE\_TIME\_MAX\_MCPI, which establish the minimum and maximum decrement time;
- (b) the average uncorrelated multiple-CPI radar report density over the entire radar coverage window as output by the Tracker during the previous 10 scans; and
- (c) the radar report density in the cell during the previous scan.

The basic decrement value for a multiple-CPI Coarse map cell is determined based on (a) and (b) above. The two VSPs establish the limits for the basic decrement value. The system maintains a current decrement time ( $t_{CM}$ ) to be applied to all multiple-CPI Coarse map cells based on the uncorrelated report density. The basic decrement value  $d_{CM}$  is calculated as follows:

$$d_{CM} = \text{COARSE\_BUMP\_MCPI} / t_{CM}$$

Initially, the decrement time is set at the minimum time value.

$$t_{CM} = \text{COARSE\_TIME\_MIN\_MCPI}$$

The uncorrelated radar target report density is measured every scan for the entire radar coverage window, and a 10 scan history is maintained. This is done using the uncorrelated radar-only report feedback stream that is sent from the 9PAC Tracker module to the C&I Adaptive Map Update task. Only reports with confidence 3, 4, or 5 are counted, which eliminates geocensor and interference reports. Every scan, during north mark processing, the C&I computes the

average uncorrelated report density for multiple-CPI reports ( $DENS_{UM}$ ) for the previous 10 scans. The idea is to make the Coarse thresholds more aggressive (i.e., decrement by a smaller value) if the uncorrelated report density is high. Conversely, if the uncorrelated report density is low, the Coarse thresholds are allowed to run less aggressively (i.e., decrement by a larger value). The rules for adjusting the current decrement time ( $t_{CM}$ ) are as follows:

If  $DENS_{UM} > (UNCORR\_DENSITY\_MCPI+5)$  then  $t_{CM} = t_{CM} + 1$

If  $DENS_{UM} < (UNCORR\_DENSITY\_MCPI-5)$  then  $t_{CM} = t_{CM} - 1$

Otherwise,  $t_{CM}$  remains the same.

The quantity  $UNCORR\_DENSITY\_MCPI$  is a VSP. Note that  $t_{CM}$  cannot exceed the limits established by the VSPs  $COARSE\_TIME\_MIN\_MCPI$  and  $COARSE\_TIME\_MAX\_MCPI$ .

Now that the basic decrement value ( $d_{CM}$ ) has been computed, the actual decrement value used for a particular cell is calculated based on the radar report density in the cell during the previous scan ( $DENS_{CMi}$ ), as follows:

If  $DENS_{CMi}$  is 0, then the threshold ( $T$ ) =  $T - d_{CM}$ .

If  $DENS_{CMi}$  is 1, then  $T = T - (d_{CM} * 0.2)$ .

If  $DENS_{CMi} > 1$ , then  $T$  remains the same.

The idea is that uncorrelated reports in a cell are an indication of false targets, since most aircraft targets correlate to a track. The presence of false targets in a cell makes it desirable to prevent the threshold from recovering too much sensitivity on a single scan. This same approach was used in the original ASR-9 adaptive map processing.

The target density for each Coarse Map cell ( $DENS_{CMi}$ ) is determined by counting the following types of reports output by the 9PAC Tracker in the feedback path to the C&I Adaptive Map Update task:

- Uncorrelated radar reports with confidence 3, 4, or 5;
- Correlated radar reports with the azimuth degrade flag set and a track age  $\leq 3$ ; and
- Correlated radar reports whose associated Track had a velocity less than a VSP ( $SLOW\_TRK\_VEL$ ).

#### 5.3.3.4 Single-CPI Coarse Map Threshold Decrement

The decrement value for a single-CPI Coarse map cell depends on the following factors:

- (a) two VSPs,  $COARSE\_TIME\_MIN\_SCPI$  and  $COARSE\_TIME\_MAX\_SCPI$ , which establish the minimum and maximum decrement time;
- (b) the average uncorrelated single-CPI radar report density over the entire radar coverage window as output by the Tracker during the previous 10 scans; and

The algorithm used for the single-CPI Coarse map is similar to that of the multiple-CPI Coarse map. The difference is that the single-CPI Coarse map decrement value is not modified based on the target density in the cell on the previous scan (see the previous section).

The decrement value for a single-CPI Coarse map cell is determined based on (a) and (b) above. The two VSPs establish the limits for the basic decrement value. The system maintains a current decrement time ( $t_{CS}$ ) to be applied to all multiple-CPI Coarse map cells based on the uncorrelated report density. The basic decrement value  $d_{CS}$  is calculated as follows:

$$d_{CS} = \text{COARSE\_BUMP\_SCPI} / t_{CS}$$

Initially, the decrement time is set at the minimum time value.

$$t_{CS} = \text{COARSE\_TIME\_MIN\_SCPI}$$

The uncorrelated radar target report density is measured every scan for the entire radar coverage window, and a 10 scan history is maintained. Density is measured at the uncorrelated radar-only report feedback stream that is sent from the 9PAC Tracker module to the C&I Adaptive Map Update task. Only reports with confidence 3, 4, or 5 are counted, which eliminates geocensor and interference reports. Every scan, during north mark processing, the C&I computes the average uncorrelated report density for multiple-CPI reports ( $DENS_{US}$ ) for the previous 10 scans. The idea is to make the Coarse thresholds more aggressive (i.e., decrement by a smaller value) if the uncorrelated report density is high. Conversely, if the uncorrelated report density is low, the Coarse thresholds are allowed to run less aggressively (i.e., decrement by a larger value). The rules for adjusting the current decrement time ( $t_{CS}$ ) are as follows:

If  $DENS_{US} > (\text{UNCORR\_DENSITY\_SCPI}+5)$  then  $t_{CS} = t_{CS} + 1$

If  $DENS_{US} < (\text{UNCORR\_DENSITY\_SCPI}-5)$  then  $t_{CS} = t_{CS} - 1$

Otherwise,  $t_{CS}$  remains the same.

The quantity  $\text{UNCORR\_DENSITY\_SCPI}$  is a VSP. Note that  $t_{CS}$  cannot exceed the limits established by the VSPs  $\text{COARSE\_TIME\_MIN\_SCPI}$  and  $\text{COARSE\_TIME\_MAX\_SCPI}$ .

### 5.3.3.5 Bird Map Threshold Decrement

Like the Coarse map, the Bird map consists of relatively few range/azimuth/Doppler cells. Thus, each cell in the Bird map is updated near the beginning of each scan based on the activity in the cell on the previous scan. The Bird map decrement value can vary from scan to scan; it is determined in a manner that is very similar to the procedure used for the multiple-CPI Coarse map (see Section 5.3.3.2).

The decrement value for a Bird map cell depends on the following factors:

- (a) two VSPs,  $\text{BIRD\_TIME\_MIN}$  and  $\text{BIRD\_TIME\_MAX}$ , which establish the minimum and maximum decrement time;
- (b) the average uncorrelated multiple-CPI radar report density over the entire radar coverage window as output by the Tracker during the previous 10 scans;
- (c) the radar report density in the cell during the previous scan; and

(d) the Bird Map state (discussed in section 5.3.4).

The basic decrement value for a Bird map cell is determined based on (a), (b), and (d) above. The two VSPs establish the limits for the basic decrement value. The system maintains a current decrement time ( $t_B$ ) to be applied to all Bird map cells based on the uncorrelated report density. The basic decrement value  $d_B$  is calculated as follows:

$$d_B = \text{BIRD\_BUMP} / t_B$$

Initially, the decrement time is set at the minimum time value.

$$t_B = \text{BIRD\_TIME\_MIN}$$

Bird Map threshold processing is best understood by referring the state diagram shown later on in Figure 5-11. The Bird Map state indicates whether or not the map is activated for use in flagging reports with amplitude below the corresponding cell's amplitude threshold (see Section 5.3.2). The radar report density method described in this section is only used for Bird Map states 0, 1, 4, and 5. For states 0 and 1, the decrement time ( $t_B$ ) must remain between the limit VSPs. For states 4 and 5, however,  $t_B$  is allowed to exceed  $\text{BIRD\_TIME\_MAX}$ , if necessary.

The uncorrelated radar target report density is measured every scan for the entire radar coverage window, and a 10 scan history is maintained. Density is measured at the uncorrelated radar-only report feedback stream that is sent from the 9PAC Tracker module to the C&I Adaptive Map Update task. Only reports with confidence 3, 4, or 5 are counted, which eliminates geocensor and interference reports. Every scan, during north mark processing, the C&I computes the average uncorrelated report density for multiple-CPI reports ( $\text{DENS}_{UM}$ ) for the previous 10 scans. The idea is to make the Bird thresholds more aggressive (i.e., decrement by a smaller value) if the uncorrelated report density is high. Conversely, if the uncorrelated report density is low, the Bird thresholds are allowed to run less aggressively (i.e., decrement by a larger value). The rules for adjusting the current decrement time ( $t_B$ ) are as follows:

If  $\text{DENS}_{UM} > (\text{UNCORR\_DENSITY\_MCPI}+5)$  then  $t_B = t_B + 1$

If  $\text{DENS}_{UM} < (\text{UNCORR\_DENSITY\_MCPI}-5)$  then  $t_B = t_B - 1$

Otherwise,  $t_B$  remains the same.

The quantity  $\text{UNCORR\_DENSITY\_MCPI}$  is a VSP. Note that  $t_B$  cannot exceed the limits established by the VSPs  $\text{BIRD\_TIME\_MIN}$  and  $\text{BIRD\_TIME\_MAX}$ , except for certain conditions described later on in the discussion of the Bird map activation algorithm (see Section 5.3.4).

Now that the basic decrement value ( $d_B$ ) has been computed, the actual decrement value used for a particular cell is calculated based on the radar report density in the cell during the previous scan ( $\text{DENS}_{Bi}$ ), as follows:

If  $\text{DENS}_{Bi}$  is 0, then the threshold ( $T$ ) =  $T - d_B$ .

If  $\text{DENS}_{Bi}$  is 1, then  $T = T - (d_B * 0.2)$ .

If  $\text{DENS}_{Bi} > 1$ , then  $T$  remains the same.

The target density for each Bird Map cell ( $DENS_{BI}$ ) is determined by counting the following types of reports output by the 9PAC Tracker in the feedback path to the C&I Adaptive Map Update task:

- Uncorrelated radar reports with confidence 3, 4, or 5;
- Correlated radar reports with the azimuth degrade flag set; and
- Correlated radar reports whose associated Track had a velocity less than a VSP ( $SLOW\_TRK\_VEL$ ).

Note that when the Bird map is in states 1-5, the multiple-CPI Coarse map decrement time is fixed at its most aggressive setting ( $COARSE\_TIME\_MAX\_MCPI$ ); it is not allowed to be adjusted using the algorithm described in section 5.3.3.2.

### 5.3.4 Bird Map Activation and Deactivation

The 9PAC Bird Map was designed to handle unusually heavy target density situations caused by bird activity. With its larger cell size, the Bird Map is able to detect and attack false targets across a wider area than the other adaptive map layers. The Bird Map is needed only a small percentage of the time at most sites. Therefore, an algorithm was developed to activate or deactivate the Bird Map when necessary.

When the Bird Map is active, it flags target reports with amplitude below the corresponding cell's amplitude threshold. The C&I outputs all "bird flagged" reports to the Radar-Beacon Merge task, where they are allowed to merge with beacon target reports. The output stream of the Merge consists of radar-beacon, beacon-only, and radar-only reports. In addition, all reports are input to the 9PAC Tracker task, which is required to output a correlated radar report stream. The Tracker treats bird-flagged radar-only reports differently from other radar-only reports. Bird-flagged reports are not used in the radar-only track initiation process, and they are only allowed to correlate to beacon tracks. They are not allowed to correlate with radar-only tracks – this results in a reduction of false tracks due to bird migration.

There are three methods for activating/deactivating the Bird Map. Before describing these methods in detail, we will first discuss the philosophy behind each method. The following list summarizes the three methods and their philosophies:

- (1) **Uncorrelated radar report density:** As the uncorrelated radar report density increases beyond a VSP value, the Coarse adaptive map is allowed to run more aggressively to react to the increased density. When the Coarse Map has reached its maximum (VSP) allowable aggressiveness, and the target density output by the Tracker is still above a reasonable amount, the Bird Map is activated. With the larger cell size, the Bird map is better able than the Coarse Map to set a threshold over a wide enough area to lower the false target density to a reasonable level.
- (2) **Bird Map Report Flagging:** There are situations in which the total report density is not very high, but there are many slow-moving non-aircraft correlated radar reports. This situation is recognized when the correlated (i.e., tracked) radar report density reaches a certain level (VSP), and the Bird Map comparison logic is finding too many (VSP) multiple-CPI target reports with amplitudes above the corresponding

thresholds in the Fine/Medium/Coarse maps, but below the corresponding Bird Map cell threshold.

- (3) **Slow Radar-Only Tracks at Same Heading:** Migratory bird activity is characterized by numerous slow-moving radar-only tracks heading in the same general direction. When the Tracker recognizes that this situation has occurred based on VSPs, it sets a flag that causes the C&I Adaptive Bird Map to be activated.

The Bird Map behavior is based on its current state, as described in the state transition diagram in Figure 5-11. The adaptive map thresholding algorithm (Section 5.3.2) and the Coarse and Bird Map decrement (Section 5.3.3.3) processes are affected by the Bird Map state. There are six states, numbered 0 through 5. Table 5-15 provides a brief description of each state, including the decrement values used for the multiple-CPI Coarse map and the Bird map. Table 5-16 provides the rules that control the transition between the states shown in Figure 5-11. Initially, the Bird Map is in state 0, in which the Bird Map maintains amplitude thresholds for each of its range/azimuth/Doppler cells, but does not flag suspected bird reports.

#### **5.3.4.1 Method 1: Uncorrelated Radar Report Density**

The Bird Map is activated if the uncorrelated multiple-CPI radar report density over the previous 10 scans (Section 5.3.3.2) exceeds a VSP value (UNCORR\_DENSITY\_MCPI+5) even after the multiple-CPI Coarse Map threshold decrement time reaches its most aggressive VSP value (COARSE\_TIME\_MAX\_MCPI). The Bird Map transitions from state 0 to 1, and the Bird Map begins to flag suspected bird reports (Section 5.3.2). The initial threshold decrement time for state 1 is defined by a VSP (BIRD\_TIME\_MIN). While the Bird Map is in state 1, the multiple-CPI Coarse Map threshold decrement time remains at its maximum allowable VSP value. The Bird Map threshold decrement time is allowed to change every scan, based on the 10-scan uncorrelated radar report density (Section 5.3.3.3). The Bird Map returns to state 0 if the 10-scan uncorrelated report density falls below the VSP value (UNCORR\_DENSITY\_MCPI - 5) even after the Bird Map threshold decrement time reaches its least aggressive VSP value (BIRD\_TIME\_MIN).



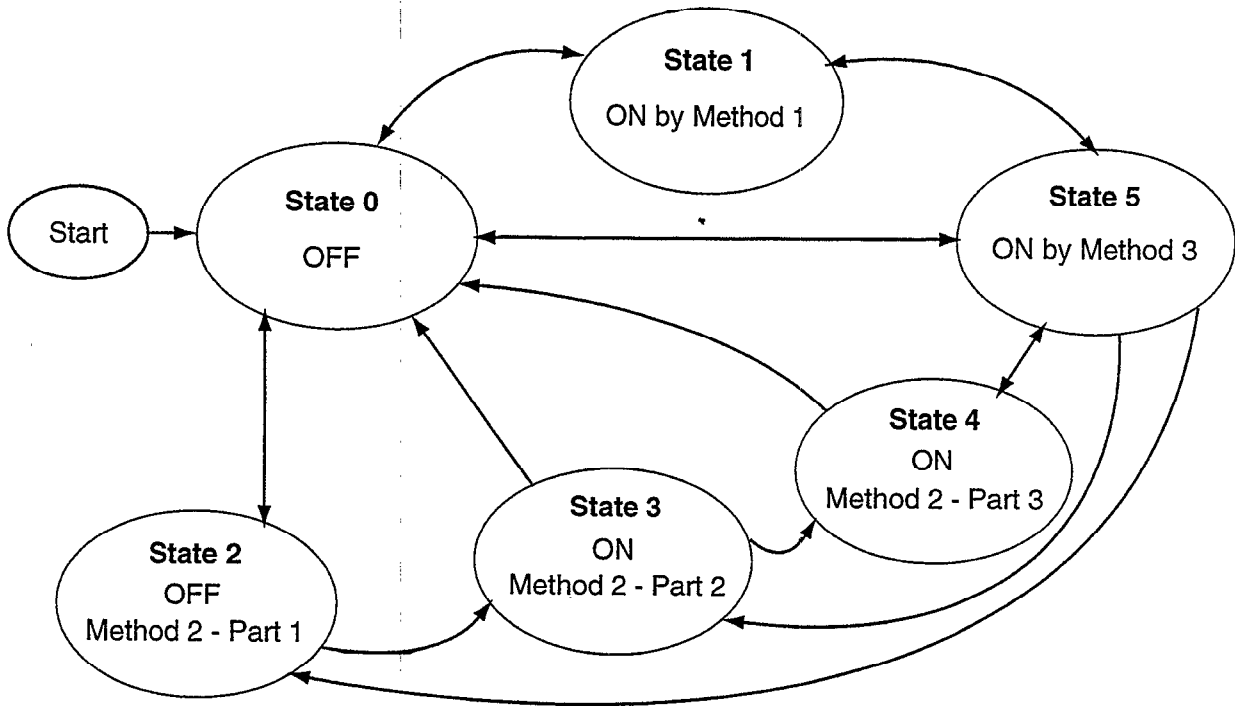

Figure 5-11. Bird map state transition diagram.

Table 5-15. Bird Map State Summary

State	Bird Map On/Off	Method	Coarse Decrement Time	Bird Decrement Time
0	Off	N/A	Between COARSE_TIME_MIN_MCPI and COARSE_TIME_MAX_MCPI	BIRD_TIME_MIN
1	On	1	COARSE_TIME_MAX_MCPI	Between BIRD_TIME_MIN and BIRD_TIME_MAX
2	Off	2	COARSE_TIME_MAX_MCPI	BIRD_TIME_MIN
3	On	2	COARSE_TIME_MAX_MCPI	BIRD_TIME_MAX
4	On	2	COARSE_TIME_MAX_MCPI	Between BIRD_TIME_MAX and 22 scans
5	On	3	COARSE_TIME_MAX_MCPI	Between BIRD_TIME_MAX and 22 scans

**Table 5-16. Bird Map State Transition Rules**

Transition	Requirements
0 to 1	(a) Multiple-CPI Coarse Decrement = COARSE_TIME_MAX_MCPI; and (b) $DENS_{UM} > (UNCORR\_DENSITY\_MCPI+5)$ (Section 5.3.3.2) Note: In state 1, section 5.3.3.3 rules for adjusting Bird Decrement are used.
1 to 0	(a) Bird Map has been in state 1 for > 60 scans; and (b) Bird Decrement = BIRD_TIME_MIN; and (c) $DENS_{UM} < (UNCORR\_DENSITY\_MCPI-5)$ (Section 5.3.3.3) Note: In state 0, section 5.3.3.2 rules for adjusting multiple-CPI Coarse Decrement are used.
0 to 2	(a) $DENS_C \geq CORR\_DENSITY\_ON$ ; and (b) $DENS_B \geq BIRD\_DEL\_ON$
2 to 3	(a) Bird Map has been in state 2 for > 30 scans; and (b) $DENS_C \geq CORR\_DENSITY\_ON$ ; and (Section 5.3.4.2) (c) $DENS_B \geq BIRD\_DEL\_ON$
3 to 4	(a) Bird Map has been in state 3 for > 30 scans; and (b) $DENS_C \geq CORR\_DENSITY\_ON$ ; and (c) $DENS_B \geq BIRD\_DEL\_ON$ Note: In state 4, section 5.3.3.3 rules for adjusting Bird Decrement are used, and Decrement must remain between BIRD_TIME_MAX and 22 scans.
2,3,4 to 0	(a) Bird Map has been in state 2,3,or 4 for > 60 scans; and (b) $DENS_C < CORR\_DENSITY\_OFF$ or (c) $DENS_B < BIRD\_DEL\_OFF$ Note: if (a) AND (b OR c)
0,1,2,3,4 to 5	(a) Tracker Bird Heading Flag = TRUE (Section 5.3.4.3) Note: In state 5, section 5.3.3.3 rules for adjusting Bird Decrement are used, and Decrement must remain between BIRD_TIME_MAX and 22 scans.
5 to 0,1,2,3,4	(a) Tracker Bird Heading Flag = FALSE (Section 5.3.4.3) Note: State 5 transitions to the previous state.

**5.3.4.2 Method 2: Correlated Report Density and Bird Report Flagging**

The Bird Map threshold comparison and increment logic (Section 5.3.2.3) counts reports with amplitude at or below the corresponding cell amplitude threshold, and measures the average number of "bird-flagged" reports during the previous 10 scans ( $DENS_B$ ). This is done even when the Bird Map is not actively flagging the suspected bird reports (e.g., states 0 and 2). The Bird Map also measures the average correlated report density over the previous 10 scans ( $DENS_C$ ).

Bird activity may be present when the overall uncorrelated radar report density is below the VSP values necessary to trigger the first method of activating the Bird Map. Another indicator of bird activity is that the Bird Map thresholding process is flagging a lot of targets as potential birds

(DENS<sub>B</sub>), and at the same time there are a lot of radar-only tracks (DENS<sub>C</sub>). The second method of activating the Bird Map relies on DENS<sub>B</sub> and DENS<sub>C</sub> to indicate bird activity, rather than the uncorrelated report density (DENS<sub>UM</sub>). If both DENS<sub>B</sub> and DENS<sub>C</sub> exceed VSP values, the Bird Map transitions from state 0 to 2. When the Bird Map has remained in state 2 for more than 30 scans, it is promoted to state 3 if the two density conditions are still exceeded. A similar transition exists from state 3 to state 4. The difference between states 2, 3, and 4 is the aggressiveness of the Coarse and Bird Map threshold decrement times. In state 2, the Bird Map remains inactive for report flagging, but the multiple-CPI Coarse Map decrement time is set to its most aggressive VSP value (COARSE\_TIME\_MAX\_MCPI). In state 3, the Bird Map is activated, but the Bird Map threshold decrement is set to its least aggressive VSP value (BIRD\_TIME\_MIN). In state 4, the Bird Map threshold decrement is raised to its most aggressive VSP value (BIRD\_TIME\_MAX). In states 2 and 3, the rules for changing the Bird Map threshold decrement time based on DENS<sub>UM</sub> (section 5.3.3.3) are not used. However, in state 4, those rules are used, but the limits are set more aggressively than for state 1. In state 4, the threshold decrement time is allowed to exceed BIRD\_TIME\_MAX up to a maximum value of 22 scans, based on DENS<sub>UM</sub>.

After 60 scans in states 2, 3, or 4, the Bird Map may be demoted to state 0 if either DENS<sub>B</sub> or DENS<sub>C</sub> fall below VSP values (BIRD\_DEL\_OFF and CORR\_DENSITY\_OFF).

#### 5.3.4.3 Method 3: Tracks at the Same Heading

Bird migration activity is characterized by numerous relatively slow moving radar-only tracks with similar headings. The Tracker, not the C&I adaptive maps, is the best place to detect this condition. Method 3 makes the Bird Map active, in state 5, when the Tracker detects bird migration. The Bird Map then remains in state 5 until the Tracker indicates that the conditions are no longer present. The Bird Map then returns to its previous state. In state 5, the threshold decrement time is determined using the same procedure as is used for state 4. The uncorrelated multiple-CPI report density (DENS<sub>UM</sub>) is compared against a VSP value (section 5.3.3.3). Like in state 4, state 5 allows the decrement time to vary between the maximum VSP (BIRD\_TIME\_MAX) and 22 scans.

Here is a summary of the Tracker algorithm used to detect bird migration. The Tracker algorithms are described in detail in [7]. The Tracker maintains a heading map, consisting of 24 bins, each of which covers a 15-degree heading region. This design is illustrated in Figure 5-12. On every scan, the Tracker counts the number of radar-only tracks with a smoothed average velocity less than a VSP. Tracks that have ever been beacon-supported are not counted, even if they subsequently become radar-only. Individual 15-degree heading map bins are grouped into 45-degree heading map tri-sectors, as shown in Figure 5-13. Note that each 15-degree heading map bin participates in three 45-degree heading map tri-sectors. The Tracker sets the "Bird Heading Flag" if any heading map tri-sector track count reached or exceeded a VSP value (TRK\_HDG\_ON\_CNT) during the previous scan. The Tracker clears the "Bird Heading Flag" if none of the heading map tri-sectors reached a separate VSP value (TRK\_HDG\_OFF\_CNT).

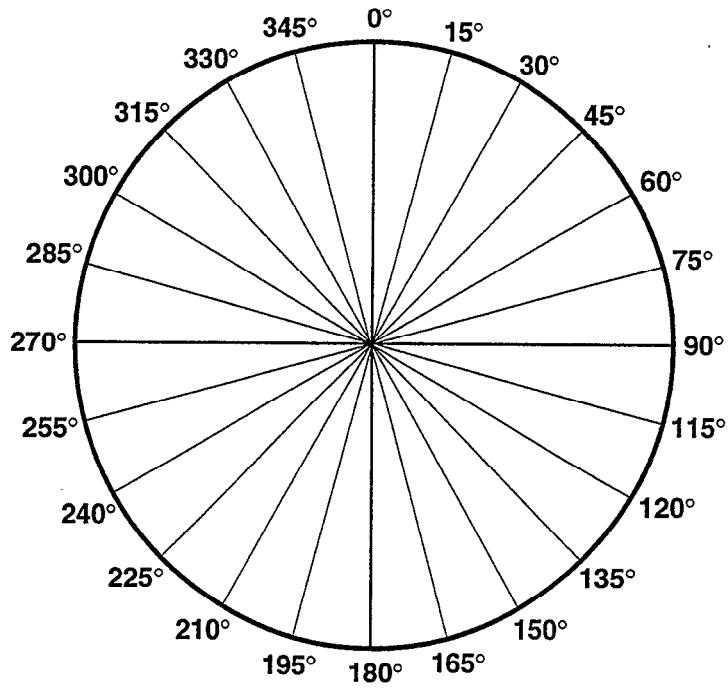

Figure 5-12. Tracker heading map bins used to detect migratory birds.

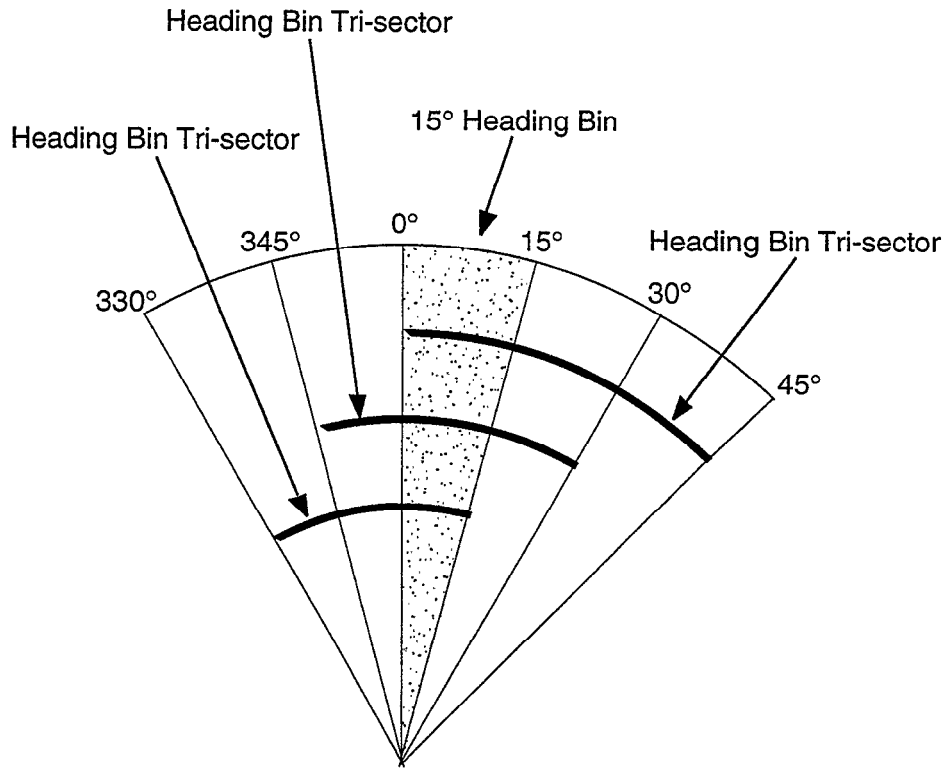

Figure 5-13. Tracker 45-degree heading map tri-sectors.

### 5.3.5 Adaptive Map Threshold Correction

One of the goals of the 9PAC Phase II adaptive map design is to prevent aircraft targets from raising the adaptive thresholds. In the original ASR-9 adaptive map design, some protection was provided by the velocity exclusion test; the 9PAC adaptive map design also provides this test (Section 5.3.2.1). Unfortunately, many aircraft do not qualify for velocity exclusion, either because they are not flying fast enough, or because they are not flying along a radial. Since the adaptive map amplitude thresholds are raised “on the fly” as target reports appear, aircraft targets that do not qualify for velocity exclusion raise the thresholds. To recover radar sensitivity, the 9PAC adaptive map design provides feedback from the Radar-Beacon Merge and Tracker tasks to allow the appropriate adaptive map cell thresholds to be corrected (i.e., decreased) for all radar/beacon reports and some correlated radar reports. This feedback design is illustrated in Figure 5-14. The part of C&I that processes the feedback path is actually implemented as a separate software task in the real-time 9PAC software application. The two tasks that make up the C&I have shared access to the adaptive maps. The Tracker also sends uncorrelated radar-only reports to the C&I adaptive map update task; these reports are used to update the uncorrelated report density counts used in determining the threshold decrement values for the Coarse and Bird adaptive map layers (see Sections 5.3.3.2, 5.3.3.3, and 5.3.4).

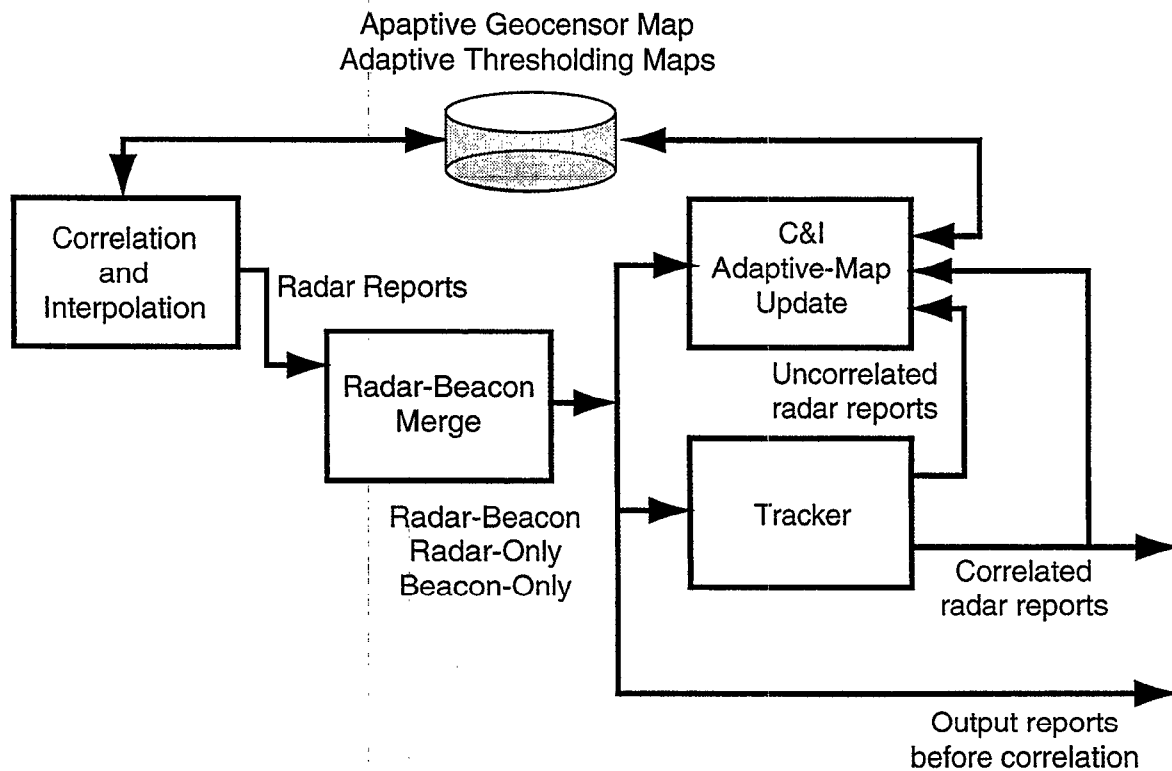

Figure 5-14. C&I adaptive map feedback block diagram.

#### 5.3.5.1 Adaptive Map Threshold Correction for Radar-Beacon Targets

It is assumed that all radar-beacon target reports correspond to aircraft. Therefore, every radar-beacon report is fed back to the adaptive map update task in order to correct the adaptive map thresholds. This process ignores target reports that were excluded from raising the adaptive map

thresholds (Section 5.3.2.1). Thus, only targets with confidence 3, 4, or 5 must be handled; confidence 4 reports that satisfied the velocity exclusion test are ignored. For a qualified report, the appropriate cells in the Fine, Medium, Coarse, and Bird adaptive maps are selected, and the threshold of each selected cell is decreased by the appropriate threshold increment VSP (e.g., FINE\_BUMP\_MCPI, MEDIUM\_BUMP\_MCPI, etc.). Multiple-CPI reports correct the thresholds of the corresponding Multiple-CPI map cells, while single-CPI reports correct the thresholds of the corresponding Single-CPI map cells.

### 5.3.5.2 Adaptive Map Threshold Correction for Correlated Radar Targets

The feedback processing is more complicated for correlated radar targets than it is for radar-beacon targets. Without the presence of a beacon target report, it is more difficult to differentiate between aircraft and non-aircraft tracks. The feedback algorithm attempts to use track velocity and heading information provided by the 9PAC Tracker to determine the appropriate amount of threshold reduction for each correlated radar report.

In order to be eligible for the adaptive map threshold correction process, a correlated radar report must have been used to raise the threshold. This means that radar confidence of the report must be 3, 4, or 5, and the report must not have satisfied the velocity or amplitude exclusion tests. Refer to Section 5.3.2.1 for a complete list of reports that excluded from raising the adaptive map thresholds.

The adaptive map correction process is slightly different for multiple-CPI and single-CPI correlated radar reports. For a qualified multiple-CPI correlated radar report, the amount of the threshold correction depends on the following factors:

- (a) the velocity ( $V$ ) of the track correlated with the report;
- (b) the heading ( $H$ ) of the track correlated with the report;
- (c) the difference between the track's heading on the current and previous scans ( $\Delta H$ );
- (d) C&I and Tracker VSP values; and
- (e) whether or not the selected map cell has already been corrected on the current scan.

Each multiple-CPI adaptive map cell is only allowed one threshold correction per scan (e) from correlated radar reports. It is assumed that an adaptive map range/azimuth/Doppler cell is unlikely to have two or more radar-only aircraft tracks at the same time.

Table 5-17 summarizes the rules for determining the threshold correction amount (dB) as a function of (a), (b), (c), and (d) above. Tracks traveling above a "fast" velocity VSP cause a threshold correction equal to the corresponding adaptive map threshold increment VSP (i.e., FINE\_BUMP\_MCPI, MEDIUM\_BUMP\_MCPI, COARSE\_BUMP\_MCPI, or BIRD\_BUMP). In other words, fast tracks are assumed to be aircraft, so the effect of the on-the-fly threshold increment is completely erased. Conversely, tracks traveling below a "slow" velocity VSP are assumed not to be aircraft, and there the corresponding adaptive map thresholds are not corrected. For tracks traveling between the "slow" and "fast" velocity VSPs, a more complicated algorithm is used, as described below.

**Table 5-17. Threshold Feedback Based for Multiple-CPI Correlated Radar Reports**

Track Velocity (V)	Decrease Threshold by (dB)
$V \geq \text{FAST\_TRK\_VEL (VSP)}$	Appropriate Threshold Increment VSP
$\text{SLOW\_TRK\_VEL (VSP)} \leq V < \text{FAST\_TRK\_VEL (VSP)}$	Depends on H, $\Delta H$ , VSPs, and Bird Map State, (See below)
$V < \text{SLOW\_TRK\_VEL (VSP)}$	0

Non-aircraft tracks resulting from bird migration can have similar velocities to that of general aviation aircraft. This can happen when migratory birds travel in the direction of the wind. The 9PAC C&I and Tracker tasks have a cooperative algorithm to try to differentiate between radar-only aircraft and bird tracks. In Section 5.3.4.3, the Tracker algorithm used to detect migratory birds was described. This algorithm is also used in the threshold correction process for tracks traveling at velocities between the "fast" and "slow" velocity VSPs.

The Tracker provides two pieces of heading information for each correlated radar report fed back to the C&I, as listed in items (b) and (c) above. The smoothed average heading of the correlated track is used to indicate tracks that are heading in the same direction as birds. The idea is that migratory birds tend to fly in the same direction. If a correlated radar report is part of a track with a heading within a 45-degree heading region with at least HDG\_TRK\_CNT (VSP) slow radar-only tracks, then the report is flagged as "heading in a bird direction." Another characteristic of bird tracks is that the scan-to-scan instantaneous heading tends to vary more than it does for aircraft tracks. The Tracker counts the number of times each radar-only track has a scan-to-scan heading change of at least HDG\_SWITCH (VSP) ACPs. If a correlated radar report is part of a track which experienced a large heading change on the current scan, then the number of heading bounces in the entire history of the track is stored in the report.

For the medium speed tracks we have been discussing, the C&I adaptive map correction process uses the track velocity and heading information (items c and d above) to determine the amount to decrease the appropriate adaptive map cell thresholds for each correlated radar report. If factors indicative of bird migration are present, the threshold is allowed to remain at a higher amplitude. Such factors would include a relatively slow velocity, a heading matching the heading of many other relatively slow-moving tracks, and a large change in heading from one scan to the next. In order to describe the algorithm details, some terms must be defined:

T = amplitude threshold

I = threshold increment VSP value (see Section 5.3.2)

D = threshold decrement value (see Sections 5.3.3 and 5.3.4)

H = smoothed track heading

$\Delta H$  = track heading change from previous scan

$\Delta H_{\text{history}}$  = total track heading change count throughout history of track

The algorithm is as follows:

If the Bird Map is not active, or H is not in a bird direction, then the threshold correction is  $(\text{SLOW\_FEED\_PCT} * I) - D$ . Refer to item (c) discussed earlier in this section.

If the Bird Map is active, and H is in a bird direction, and  $\Delta H < \text{HDG\_SWITCH}$ , then the threshold correction is  $(\text{BIRD\_FEED\_PCT} * I) - D$ . Refer to item (d) discussed earlier in this section.

If the Bird Map is active, and H is in a bird direction, and  $\Delta H \geq \text{HDG\_SWITCH}$ , then the threshold correction is the larger of  $\text{MIN\_FEED\_PCT}$  and  $(\text{BIRD\_FEED\_PCT} - (\text{STEP\_FEED\_PCT} * \Delta H_{\text{history}}))$ .

The correction algorithm for single-CPI correlated radar reports is the same as for multiple-CPI reports, with the following exceptions:

- Single-CPI adaptive map cells have no limit on the number of threshold corrections per scan. Refer to item (e) discussed earlier in this section.
- The velocity limits are different, as shown in Table 5-18.

**Table 5-18. Threshold Feedback Based for Single-CPI Correlated Radar Reports**

Track Velocity (V)	Decrease Threshold by (dB)
$V \geq \text{FAST\_TRK\_VEL (VSP)}$	Appropriate Threshold Increment VSP
$80 \text{ knots} \leq V < \text{FAST\_TRK\_VEL (VSP)}$	Depends on H, $\Delta H$ , VSPs, and Bird Map State, (See above)
$V < 80 \text{ knots}$	0



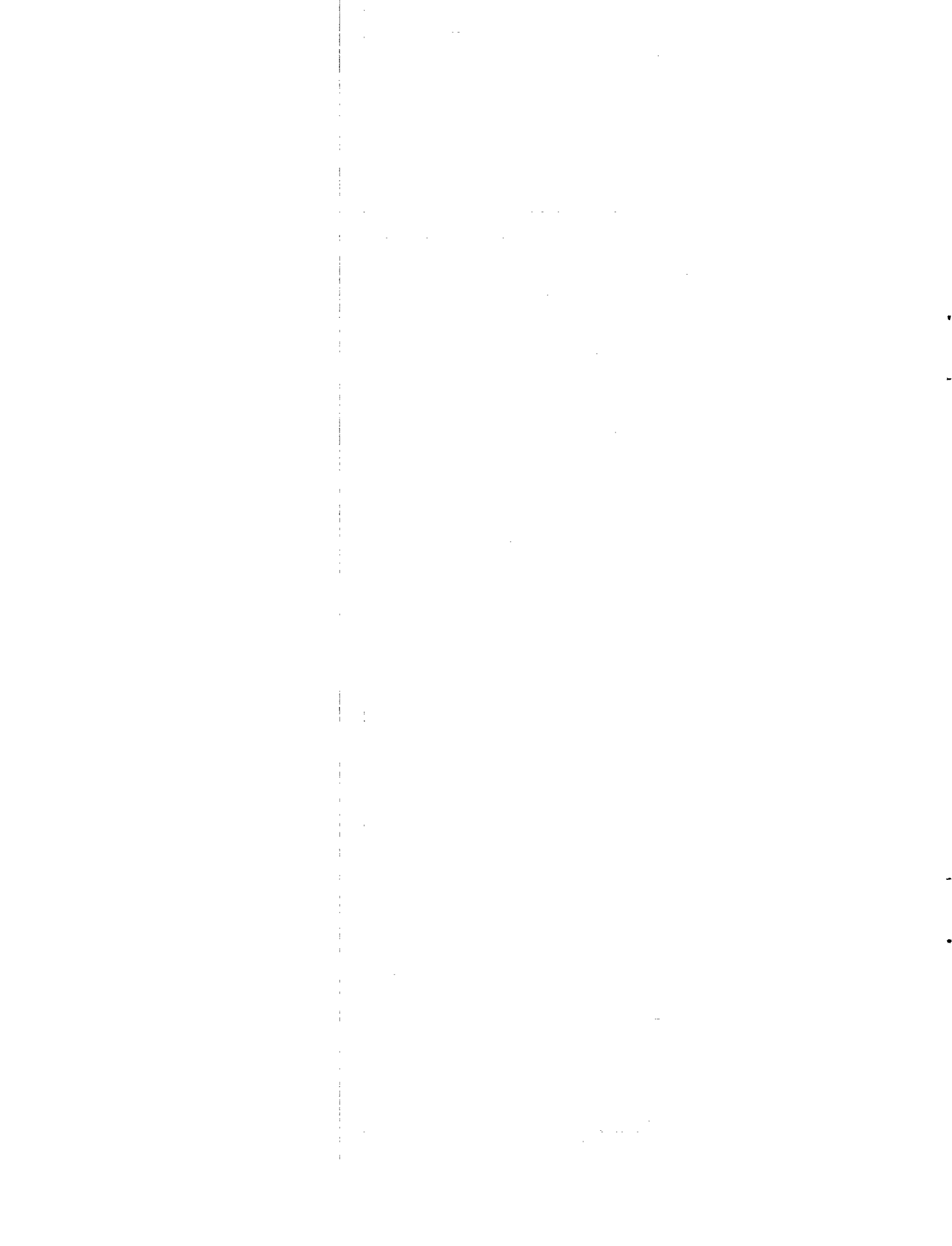

## 6. TWO-LEVEL WEATHER

Two-level weather data is output by the ASR-9 front end on an alternating-scan basis, with each scan containing either level 1 or level 2 weather detections. The resolution of the weather data is 0.5 nmi by 1.4 degrees. The ASR-9 specification requires that the incoming data be temporally and spatially smoothed, with a new map output to the Surveillance and Communications Interface Processor (SCIP) every 30 seconds. The 9PAC C&I processes two-level weather data in the same way that the original ASP-based C&I did.

### 6.1 TEMPORAL SMOOTHING

Temporal smoothing is performed at each individual range/azimuth cell. Because the required time between weather map outputs is 30 seconds, three scans of low-level and three scans of high-level weather are available for smoothing. The algorithm is simple: if the cell contains a detection on two out of three scans, then it is declared to be a detection. The output from the temporal smoothing operation is then passed to the contouring step.

### 6.2 CONTOURING

Contouring (or spatial smoothing) counts the number of weather detections in each 3x3 group of cells and declares a hit in all 9 cells if the total count exceeds the VSP WX\_CONTOUR\_THR (default value is 5). Cells at 0 range and full range, where only six cells are available for contouring, use  $0.66 * \text{WX\_CONTOUR\_THR}$  (default value is 3) as a threshold. Following the contouring operation, the completed map is reformatted and then output to the MIP. The reformatting consists of two steps. The first step is to turn off the level 1 weather detection for any cell that also has a level 2 weather detection. The second step is to apply a 1 range cell (0.5 nmi) bias to the data; the range cell closest to the radar retains its data. The range bias was added to match what was in the ASP-based C&I assembly code. No documentation was found supporting this modification, but the FAA requested that the 9PAC two-level weather output match that of the original ASR-9.

In order to prevent clutter from causing false weather detections, the ASR-9 front-end utilizes a clear day map generated by the following process. When the CLEAR\_DAY\_MAP mode bit is set in the weather data header block of the input radar primitives, the contouring algorithm is not performed, in order to allow an accurate representation of the ground clutter to be generated. Once completed, the clear day map is output via the normal mechanism to the ASR-9, where it is stored in non-volatile memory.

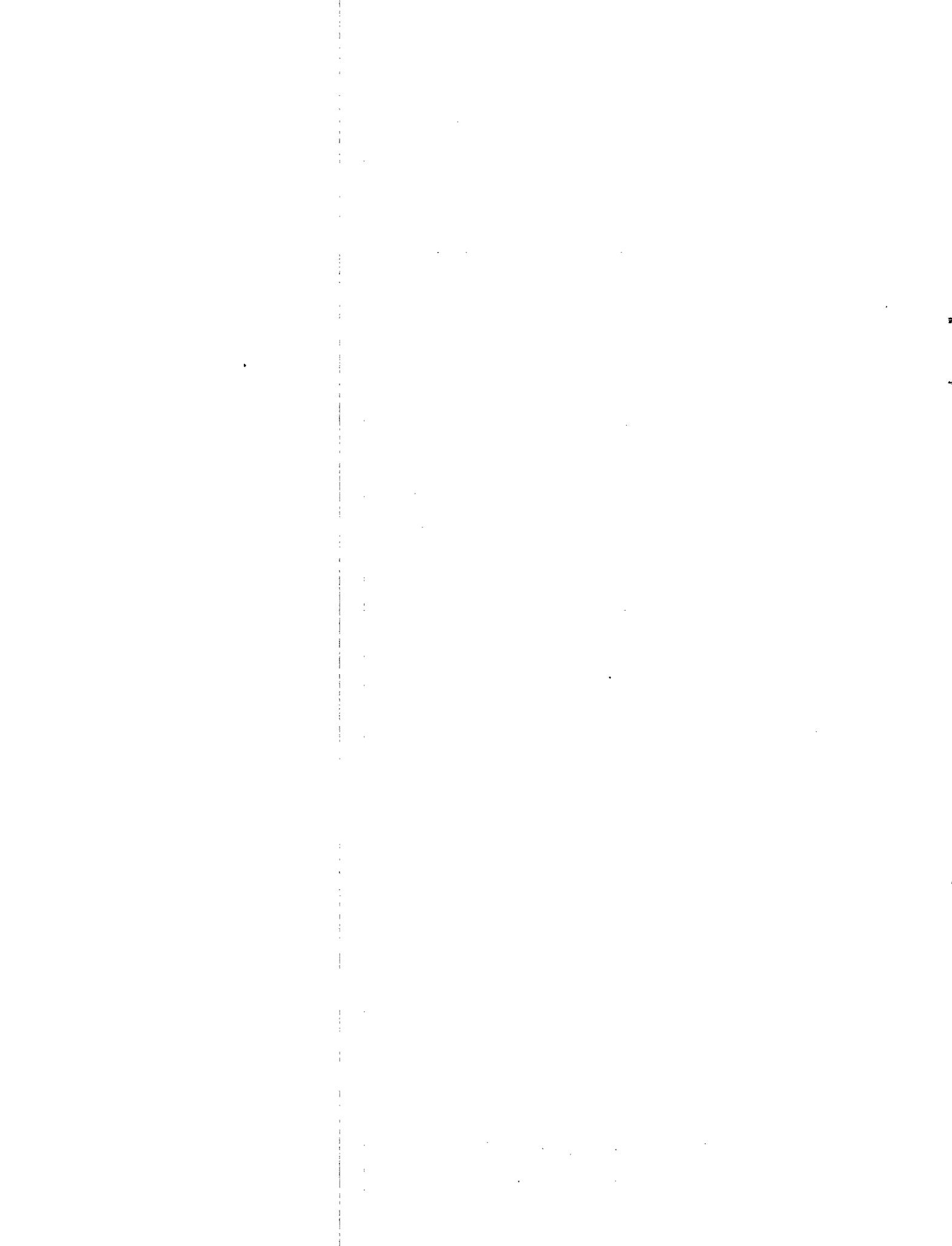

## 7. PROJECT STATUS

The 9PAC C&I algorithms have been implemented using the ANSI-C programming language. The C&I software is part of the 9PAC Phase II application software that runs in the 9PAC board. In addition, the C&I software can be run as part of an algorithm test bed (SUNPAC[9]) on UNIX-based computers.

9PAC Phase II is currently being tested at operational ASR-9 airport sites. To date, Phase II has been installed at Dallas-Fort Worth (DFW), Salt Lake City (SLC), and Honolulu (HNL). FAA personnel are leading this effort; the 9PAC project development team at MIT Lincoln Laboratory is providing telephone support, examining data files recorded in the field, and investigating any software performance issues that arise. Generally, FAA personnel dedicated to 9PAC Phase II testing monitor each site for at least a month, or until system performance is deemed acceptable. With FAA approval, 9PAC Phase II is left running at the site, and the installation and monitoring team moves on to the next site.

Prior to operational testing, Phase II was developed and tested at MIT Lincoln Laboratory, using the algorithm test bed, a VME-based real-time simulator, and non-operational ASR-9 radar systems on loan to MIT Lincoln Laboratory in Lexington, MA, and Albuquerque, NM. In December, 1999, radar interface testing was completed by FAA and MIT Lincoln Laboratory personnel at Lexington, MA, and the WJH Technical Center (WJHTC) in Atlantic City, NJ. Preliminary FAA acceptance testing was conducted in January 2000 at the MIT Lincoln Laboratory ASR-9 site in Albuquerque. In addition, the 9PAC C&I and Tracker [7] algorithm performance was evaluated using the algorithm test bed with data recorded by FAA personnel at operational ASR-9 sites in Oakland, SLC, St. Louis, et al.

Operational testing began at DFW in February 2000. From the start, Phase II C&I and Tracker demonstrated both improved aircraft detection and reduced false track rate when compared with the baseline ASR-9 ASP radar processing. However, migratory bird activity was generating many non-aircraft tracks at DFW, and with FAA approval, algorithm changes were made to the 9PAC C&I adaptive thresholding map and Tracker design to provide an improved false alarm control mechanism with many tunable site parameters. Of course, the process of designing, coding, testing, and tuning the system required the testing at DFW to be extended for a few months (into June).

Operational testing began at SLC at the end of June 2000. The biggest challenge at SLC was maneuvering radar-only military aircraft taking off from nearby Hill Air Force Base. Once again, 9PAC Phase II demonstrated noticeable improvements in the detection and tracking of military aircraft. The Tracker algorithm was modified slightly and a few Variable Site Parameters (VSPs) were adjusted in order to accommodate the tracking of military aircraft maneuvers while minimizing the increase of false tracks.

Based on testing completed thus far, the adaptive geocensoring and other adaptive thresholding maps described in this report provide the ASR-9 with improvements in both aircraft detection and false alarm suppression. However, two sites is an insufficient sample size to provide the broad range of environmental conditions necessary to establish the optimal VSP settings. FAA personnel will complete this task in the coming months. MIT Lincoln Laboratory funding for

this project is expected to end at the end of this year. The technology transfer process between engineers at Lincoln Laboratory and the FAA (AOS-270) is well underway.

One remaining software task is to define, implement, and test the final interface between 9PAC Phase II, the ASR-9 Message Interface Processor (MIP), and the ASR-9 Remote Monitoring System (RMS). This interface defines the control messages, VSPs, and performance monitoring information that is passed between these processors. The RMS provides the operator console used by site technicians to maintain the ASR-9 and ensure that it is satisfying its performance specifications. In the absence of a Phase II RMS, a work-around was developed at MIT Lincoln Laboratory that uses a UNIX-based computer and the high-speed serial data capability (used for data extraction) to replace the RMS C&I and Tracker operator interface. The effort to finalize the 9PAC Phase II to MIP interface is underway at Lincoln Laboratory and the AOS-270; software development and testing should be completed within a couple of months. AOS-270 will complete the interface between the MIP and RMS at a later date.

## APPENDIX A. VARIABLE SITE PARAMETERS (VSP)

The C&I is configurable via a set of VSPs, that are currently input to the real-time 9PAC Phase II software from a Sun workstation using the PACVSP software tool. Eventually, these VSPs will be added to the RMS download message that is input to 9PAC via the MIP. Note that in the current design, each time a VSP message is processed, C&I must reset in order to update internal lookup tables, thereby causing a brief interruption in the output data. This is comparable with the original design and is not a problem, since the ASR-9 does not allow the VSPs to be updated while a channel is on-line.

The C&I VSPs are broken into the following categories as separate RMS messages:

- C&I
- C&I Amplitude Exclusion Table
- C&I Fixed Geocensor Cell Table

### A.1 C&I VSP MESSAGE

This section describes the main C&I VSP message parameters. The parameters are divided into the following groups: RFI processing; adaptive thresholding; geocensoring; and miscellaneous. For each VSP, a reference is provided indicating the section in this report to look at for further information.

#### A.1.1 RFI PROCESSING

<b>RFI_ENABLE</b>	Enable RFI filter crossing test. Default is Enabled (1). (Section 4.5)
<b>RFI_HI_THR</b>	High PRF filter crossing threshold. Single CPI (High PRF) targets containing RFI_HI_THR or more filter crossings are deleted. Default is 5. (Section 4.5)
<b>RFI_LO_THR</b>	Low PRF filter crossing threshold. Single CPI (Low PRF) targets containing RFI_LO_THR or more filter crossings are deleted. Default is 5. (Section 4.5)
<b>SUPP_RFI_ENABLE</b>	Enable supplemental RFI single CPI target density test. Default is disabled (0). (Section 4.5)

**SUPP\_RFI\_DEL\_THR**

Single CPI target deletion threshold. If the number of single CPI targets in a single 4 CPIP (5 degree) wedge reaches or exceeds this number, then all single CPI targets above this number are deleted as RFI. Default value is 50. (Section 4.5)

**A.1.2 ADAPTIVE THRESHOLDING**

**ADAPT\_SWITCH**

Enable/disable all adaptive thresholding, including the Fine, Medium, Coarse, and Bird map adaptive thresholding maps. Default is enabled (1). (Section 5.3)

**ADAPT\_FINE\_SWITCH**

Independent enable/disable switch for Fine map thresholding. Default is enabled (1). (Section 5.3)

**ADAPT\_MEDIUM\_SWITCH**

Independent enable/disable switch for Medium map thresholding. Default is enabled (1). (Section 5.3)

**ADAPT\_COARSE\_SWITCH**

Independent enable/disable switch for Coarse map thresholding. Default is enabled (1). (Section 5.3)

**ADAPT\_BIRD\_SWITCH**

Independent enable/disable switch for Bird map thresholding. Default is enabled (1). Note that this switch does not control whether or not the Bird Map is "active" (Section 5.3).

**ID\_TEST\_VEL**

Doppler velocity, expressed in knots, at or above which a target is considered to be an aircraft, and is excluded from adaptive thresholding. Default value is 80 knots. (Sections 5.3.2.1, 4.6.4)

**FINE\_BUMP\_MCPI**

Fine adaptive map thresholding increment (dB) for qualified multiple-CPI reports above the threshold in a particular range/azimuth/Doppler cell. Note that only reports with confidence 3, 4, or 5 are allowed to increment the Fine map adaptive threshold. Default value is 3 dB. (Section 5.3.2.2)

**FINE\_TIME\_MCPI**

Threshold decrement time for the multiple CPI Fine adaptive map. This is the number of scans it takes for the Fine map thresholds to be decreased by **FINE\_BUMP\_MCPI** dB. Default is 48 scans. (Section 5.3.3.1)

**FINE\_BUMP\_SCPI**

Fine adaptive thresholding increment (dB) for qualified single-CPI reports above the threshold in a particular range/azimuth/Doppler cell. Note that only reports with confidence 3, 4, or 5 are allowed to increment the fine map adaptive threshold. Default value is 3 dB. (Section 5.3.2.2)

**FINE\_TIME\_SCPI**

Threshold decrement time for the single CPI Fine adaptive map. This is the number of scans it takes for the fine map thresholds to be decreased by **FINE\_BUMP\_SCPI** dB. Default is 48 scans. (Section 5.3.3.1)

**MEDIUM\_BUMP\_MCPI**

Medium adaptive thresholding increment (dB) for qualified multiple-CPI reports above the threshold in a particular range/azimuth/Doppler cell. Note that only reports with confidence 3, 4, or 5 are allowed to increment the medium map adaptive threshold. Default value is 3 dB. (Section 5.3.2.2)

**MEDIUM\_TIME\_MCPI**

Threshold decrement time for the multiple CPI Medium adaptive map. This is the number of scans it takes for the medium map thresholds to be decreased by **MEDIUM\_BUMP\_MCPI** dB. Default is 18 scans. (Section 5.3.3.1)

**MEDIUM\_BUMP\_SCPI**

Medium adaptive thresholding increment (dB) for qualified single-CPI reports above the threshold in a particular range/azimuth/Doppler cell. Note that only reports with confidence 3, 4, or 5 are allowed to increment the medium map adaptive threshold. Default value is 3 dB. (Section 5.3.2.2)

**MEDIUM\_TIME\_SCPI**

Threshold decrement time for the single CPI Medium adaptive map. This is the number of scans it takes for the



medium map thresholds to be decreased by **MEDIUM\_BUMP\_SCPI** dB. Default is 36 scans. (Section 5.3.3.1)

**COARSE\_BUMP\_MCPI**

Coarse adaptive thresholding increment (dB) for qualified multiple-CPI reports above the threshold in a particular range/azimuth/Doppler cell. Note that only reports with confidence 3, 4, or 5 are allowed to increment the coarse map adaptive threshold. Default value is 3 dB. (Section 5.3.2.2)

**COARSE\_TIME\_MIN\_MCPI**

Minimum threshold decrement time for the multiple CPI Coarse adaptive map. This is the minimum number of scans it takes for the Coarse adaptive map thresholds to be decreased by **COARSE\_BUMP\_MCPI** dB if no target reports are present in the cell. Default is 4 scans. (Section 5.3.3.2)

**COARSE\_TIME\_MAX\_MCPI**

Maximum threshold decrement time for the multiple CPI Coarse adaptive map. This is the maximum number of scans it takes for the Coarse adaptive map thresholds to be decreased by **COARSE\_BUMP\_MCPI** dB if no target reports are present in the cell. Default is 8 scans. (Section 5.3.3.2)

**COARSE\_BUMP\_SCPI**

Coarse adaptive thresholding increment (dB) for qualified single-CPI reports above the threshold in a particular range/azimuth/Doppler cell. Note that only reports with confidence 3, 4, or 5 are allowed to increment the coarse map adaptive threshold. Default value is 3 dB. (Section 5.3.2.2)

**COARSE\_TIME\_MIN\_SCPI**

Minimum threshold decrement time for the single CPI Coarse adaptive map. This is the minimum number of scans it takes for the coarse map thresholds to be decreased by **COARSE\_BUMP\_SCPI** dB. Default is 4 scans. (Section 5.3.3.2)

**COARSE\_TIME\_MAX\_SCPI**

Maximum threshold decrement time for the single CPI Coarse adaptive map. This is the maximum number of

scans it takes for the coarse map thresholds to be decreased by **COARSE\_BUMP\_SCPI** dB. Default is 150 scans. (Section 5.3.3.2)

**BIRD\_BUMP**

Bird adaptive thresholding increment (dB) for qualified multiple-CPI reports above the threshold in a particular range/azimuth/Doppler cell. Note that only reports with confidence 3, 4, or 5 are allowed to increment the Bird map adaptive threshold. Default value is 3 dB. (Section 5.3.2.3)

**BIRD\_TIME\_MIN**

Minimum threshold decrement time for the Bird adaptive map. This is the minimum number of scans it takes for the Bird adaptive map thresholds to be decreased by **BIRD\_BUMP** dB if no target reports are present in the cell. Default is 8 scans. (Section 5.3.3.3)

**BIRD\_TIME\_MAX**

Maximum threshold decrement time for the Bird adaptive map. This is the maximum number of scans it takes for the Bird adaptive map thresholds to be decreased by **BIRD\_BUMP** dB if no target reports are present in the cell. Default is 15 scans. (Section 5.3.3.3)

**UNCORR\_DENSITY\_MCPI**

Average uncorrelated multiple-CPI confidence 3, 4, or 5 radar target density in uncorrelated feedback path from Tracker to C&I Adaptive Map Update task. This VSP is used to adjust the multiple-CPI Coarse and Bird adaptive map threshold decrement time. If 10-scan average of uncorrelated reports NOT flagged by the Bird map is  $< (\text{UNCORR\_DENSITY\_MCPI}-5)$ , the decrement times are made faster (i.e., more sensitive). If the 10-scan average is  $> (\text{UNCORR\_DENSITY\_MCPI}+5)$ , the decrement times are made slower (i.e., less sensitive). Note that the decrement times are bounded by the “MIN” and “MAX” VSPs defined above. Default value is 45. (Sections 5.3.3.2, 5.3.3.3, and 5.3.4)

**UNCORR\_DENSITY\_SCPI**

Average uncorrelated single-CPI confidence 3, 4, or 5 radar target density in uncorrelated feedback path from Tracker to C&I Adaptive Map Update task. This VSP is used to adjust the single-CPI Coarse adaptive map threshold

decrement time. If 10-scan average of uncorrelated reports NOT flagged by the Bird map is < (UNCORR\_DENSITY\_SCPI-5), the decrement time is made faster (i.e., more sensitive). If the 10-scan average is > (UNCORR\_DENSITY\_SCPI+5), the decrement time is made slower (i.e., less sensitive). Note that the decrement time is bounded by the "MIN" and "MAX" VSPs defined above. Default value is 32. (Sections 5.3.3.2, 5.3.3.3, and 5.3.4)

#### **CORR\_DENSITY\_ON**

Average confidence 3, 4, or 5 correlated radar target density in feedback path from Tracker to C&I Adaptive Map Update task. In order for the Bird Adaptive Map to be activated, there must be a minimum of CORR\_DENSITY\_ON correlated reports average (per scan) over the previous 10 scans. Default value is 6.

#### **CORR\_DENSITY\_OFF**

Bird adaptive map is deactivated if it has been on a minimum of 120 scans and the 10-scan average of correlated radar targets from confidence 3, 4, and 5 is below CORR\_DENSITY\_OFF. Default value is 3. (Section 5.3.4)

#### **BIRD\_DEL\_ON**

This VSP is part of the criteria used to activate the Bird Map by method 2. Average number of radar targets with amplitude at or below the corresponding Bird Map cell's amplitude threshold during the previous 10 scans required to for method 2. This parameter is used to transition from Bird Map state 0 to 2, 2 to 3, and 3 to 4. Default value is 12. Note that CORR\_DENSITY\_ON is used in conjunction with BIRD\_DEL\_ON. (Section 5.3.4)

#### **BIRD\_DEL\_OFF**

This VSP is part of the criteria used to deactivate the Bird adaptive map by method 2. Bird Map may be deactivated if the average number of radar targets with amplitude at or below the corresponding Bird Map cell's amplitude threshold during the previous 10 falls below BIRD\_DEL\_OFF. Default value is 9 (Section 5.3.4).

#### **FAST\_TRK\_VEL**

This VSP specifies a track velocity cutoff between aircraft tracks and potentially non-aircraft tracks. This parameter is

used in the Tracker-to-C&I feedback mechanism for correlated radar-only reports. The default value is 190 knots. Note that this parameter is identical to the Tracker VSP `FDBK_SLOW_VEL`. (Sections 5.4 and 5.5)

### **SLOW\_TRK\_VEL**

This VSP specifies a track velocity between tracks that may or may not be aircraft and tracks that are definitely not aircraft. This parameter is used in the Tracker-to-C&I feedback mechanism to allow correlated radar-only reports that are part of extremely slow-moving tracks to be treated the same as uncorrelated reports (i.e., allow the adaptive map thresholds to be raised). The default value is 0 knots, which effectively disables this VSP. (Sections 5.4 and 5.5)

### **SLOW\_FEED\_PCT**

This VSP specifies the percent of the threshold increment VSP to recover (i.e., reduce the corresponding cell's threshold by) for correlated radar-only reports (in the Tracker-to-C&I report feedback mechanism) from tracks with velocity < `FAST_TRK_VEL` VSP when there is no heading information that indicates a potential bird track. Note that there are three separate VSPs to handle feedback in cases where heading information indicates a potential bird track. The default value is 100 percent. (Section 5.3.5.2)

### **BIRD\_FEED\_PCT**

This VSP specifies the percent of the threshold increment VSP to recover (i.e., reduce the corresponding cell's threshold by) for correlated radar-only reports from tracks with velocity < `FAST_TRK_VEL` VSP when there is evidence of a potential bird track from the track's heading. See section 5.3.5.2 for a complete description of the algorithm. Note that the VSPs `STEP_FEED_PCT` and `MIN_FEED_PCT` are also used in determining the feedback amount for potential bird tracks. The default value of `BIRD_FEED_PCT` is 100 percent. (Section 5.3.5.2)

### **STEP\_FEED\_PCT**

This VSP specifies an additional percent of the threshold increment VSP to recover for potential bird tracks that have a history of large scan-to-scan heading changes. This is used in determining the threshold correction (i.e., feedback) amount for correlated radar-only reports from tracks with

velocity < FAST\_TRK\_VEL VSP. See section 5.3.5.2 for a complete description of the algorithm. Note that the VSPs BIRD\_FEED\_PCT and MIN\_FEED\_PCT are also used in determining the feedback amount for potential bird tracks. The default value of STEP\_FEED\_PCT is 13 percent. (Section 5.3.5.2)

**MIN\_FEED\_PCT**

This VSP specifies the minimum percent of the threshold increment VSP to recover (i.e., reduce the corresponding cell's threshold by) for correlated radar-only reports from potential bird tracks. See section 5.3.5.2 for a complete description of the algorithm. Note that the VSPs BIRD\_FEED\_PCT and STEP\_FEED\_PCT are also used in determining the feedback amount for potential bird tracks. The default value of MIN\_FEED\_PCT is 0 percent. (Section 5.3.5.2)

**ADAPT\_THR\_RANGE**

This VSP defines the range cutoff between confidence values 3 and 5. This parameter is entered in 64<sup>th</sup> of nmi units. The default value is 2560 (40 nmi), which corresponds to the geocensor map maximum range. Note that there is an identical parameter in the Tracker called "Eligibility Range" [7]; in the real-time system, the two parameters are fed with the same value. (Section 5.3)

**ADAPT\_MAX\_THR[3][15]**

Amplitude exclusion table for adaptive threshold map. This table provides maximum adaptive threshold values (dB) for 15 range bands for each of 3 Doppler filter classes. Target reports with amplitude above the appropriate maximum amplitude value from the table are never deleted by the adaptive maps, and are never allowed to raise the corresponding adaptive map thresholds. The default values are shown in the table below. (Section 5.3.2.1)

**Range (NMI)**

Dop	< 3	3-6	6-9	9-12	12-15	15-18	18-21	21-24	24-27	27-30	30-36	36-42	42-48	48-54	54-60
±0	95	95	95	95	95	95	95	95	95	95	95	95	95	55	55
±1	95	95	95	95	95	95	95	95	95	95	95	95	95	55	55
Other	95	95	95	95	95	95	95	95	95	95	95	95	95	95	55

### A.1.3 GEOCENSORING

**GEO\_SWITCH** Independent enable/disable switch for geocensoring. Default is enabled (1). (Section 5.2)

**GEO\_BIAS\_NEW** Geo threshold bias (dB) for geo cells created within the current 512-scan block. This bias is added to the amplitude threshold of a newly created geocensor cell when comparing a target amplitude with the threshold to determine radar confidence 0 or 1. A newly created geocensor cell is one that has been created during the current 512-scan block. For subsequent blocks, either **GEO\_BIAS\_MCPI** or **GEO\_BIAS\_SCPI** is used, as appropriate. Default value is 8 dB. (Section 5.2.3.2)

**GEO\_CONFI\_DISABLE** Confidence 1 disable for newly created geocensor cells. For geocensor cells created during the current 412-scan block, the amplitude threshold for the cell may not accurately reflect the false target data, because the cell has not been around long enough yet. Therefore, this parameter, when set to 1 (the default value), forces all reports in the geocensor cell to be called confidence 0, regardless of the amplitude of the target compared with the amplitude threshold of the geocensor cell. Default value is 1, which means disable confidence 1. A value of 0 for this parameter allows normal threshold comparisons to occur that may generate confidence 1 target reports. (Section 5.2.3.2)

**GEO\_DECR\_MCPI** Geo threshold decrement (dB) for one 512-scan block for the multiple CPI geocensor map. The 9PAC geo map cell thresholds are decremented once every 512 scans. In order to save CPU usage, each azimuth wedge has all of its cells decremented on the same scan, spread out throughout the scan. Therefore, in 512 scans, all 512 azimuth CPI wedges of the geo map are updated. Default is 1 dB. (Section 5.2.2)

**GEO\_BIAS\_MCPI** Geo threshold bias (dB) for geo cells in the multiple CPI map. Note that this applies to cells that were not newly created within the current 512-scan block. This bias is

added to the amplitude threshold of a geocensor cell when comparing a target amplitude with the threshold to determine radar confidence 0 or 1. Default value is 8 dB. (Section 5.2.3.2)

#### **GEO\_DEL\_CNT\_MCPI**

Multiple CPI geo map target density requirement for report deletion. An active geo cell (normal, elephant, or permanent) that reaches this number of qualified targets within a 512-scan block immediately is allowed to delete reports below the amplitude threshold of the geo cell for the remainder of the block. In addition, the geo cell is flagged so that it may delete all reports in the next block with amplitude below the deletion amplitude threshold, as defined by the parameter **GEO\_DEL\_THR\_MCPI** below. The value of this parameter may range from 0 to 7. Default is 0. Note that multiple CPI reports "deleted" by the geocensor map are actually output to the Merge, but they are not allowed to initiate or associate with radar-only tracks. (Section 5.2.3.2)

#### **GEO\_DEL\_THR\_MCPI**

Multiple CPI geo map target deletion amplitude threshold (dB). A geo cell that has satisfied the **GEO\_DEL\_CNT\_MCPI** target count parameter on the previous 512-scan block is allowed to delete all targets with amplitude this many dB below the geo cell's amplitude threshold. Note that only active geo cells (normal, active elephant, or permanent) may censor target reports. The value of this parameter may range from 0 to 99 dB. Default is 0. Note that multiple CPI reports "deleted" by the geocensor map are actually output to the Merge, but they are not allowed to initiate or associate with radar-only tracks. (Section 5.2.3.2)

#### **GEO\_TGT\_CNT\_DOP1\_MCPI**

Geo target count within a 512-scan block required to create a normal active geo cell in the multiple CPI map for Doppler filters -1 and +1. As soon as this many qualified target reports have occurred in the cell, a normal active geo cell is created, if it doesn't already exist. At the end of the block, if a cell has reached or exceeded this target count, the active block count of the cell is incremented. Default value is 2. (Section 5.2.1.4)

- GEO\_KILL\_CNT\_DOP1\_MCPI** Normal geo cell kill target count for multiple CPI geo map for Doppler filters -1 and +1. If at the end of a 512-scan block, a normal geo cell exists with a target count less than this parameter, the geo cell is deactivated (killed) and becomes a non-geo cell. Default value is 1, meaning that a normal geo cell is killed if its latest block saw 0 target reports. (Section 5.2.1.4)
- GEO\_EL\_BLK\_M\_DOP1\_MCPI** Number of active blocks (i.e., blocks with at least **GEO\_TGT\_CNT\_DOP1\_MCPI** target reports) required change a normal active geo cell to an active elephant geo cell for Doppler filters -1 and +1 in the multiple CPI geo map. This parameter is the “M” in an “M out of N” block count requirement. The “N” parameter is **GEO\_EL\_BLK\_N\_DOP1\_MCPI**. As soon as “M” active blocks occur, a normal geo cell is changed to an elephant geo cell, even if the “N” total blocks have not yet been reached. Valid values range from 1 through 127. Default value is 30. (Section 5.2.1.4)
- GEO\_EL\_BLK\_N\_DOP1\_MCPI** Total number of blocks over which at least **GEO\_EL\_BLK\_M\_DOP1\_MCPI** must have satisfied the **GEO\_TGT\_CNT\_DOP1\_MCPI** target count requirement in order for a geo cell to be considered an elephant cell for Doppler filters -1 and +1 in the multiple CPI geo map. This parameter is the “N” in an “M out of N” block count requirement for elephant geo cell status. Valid values range from 1 through 127. Default value is 127. (Section 5.2.1.4)
- GEO\_EL\_ACT\_DOP1\_MCPI** Target count within a 512-scan block required to activate an inactive elephant geo cell for Doppler filters -1 and +1 in the multiple CPI geo map. As soon as this many qualified target reports have occurred in the cell, an inactive elephant geo cell is activated. Remember that only active geo cells can be used to censor target reports. Default is 1. (Section 5.2.1.4)
- GEO\_EL\_DEACT\_DOP1\_MCPI** Minimum target count within a 512-scan block required to maintain an active elephant geo cell for Doppler filters -1 and +1 in the multiple CPI geo map. If an active elephant geo cell has less than this number of qualified targets in a



512-scan block, the state of the cell is changed to inactive elephant. Remember that inactive geo cells cannot be used to censor target reports. Default is 1, meaning that 0 targets in a 512-scan block causes an elephant geo cell to be deactivated. (Section 5.2.1.4)

**GEO\_PERM\_PCT\_DOP1\_MCPI** Percentage of active to total blocks (i.e.,  $100 * M/N$ ) required to promote elephant geo cells to permanent geo cell status for Doppler filters -1 and +1 in the multiple CPI geo map. When this ratio of active blocks to total blocks reaches this number, a geo cell is changed from elephant to permanent. When the ratio falls below this number, a permanent geo cell is changed to elephant. Remember that permanent geo cells are always active – this cannot be disabled as long as they remain permanent. Valid values range from 1 to 100 percent. Default value is 35. (Section 5.2.1.4)

**GEO\_TGT\_CNT\_DOP2\_MCPI** Geo target count within a 512-scan block required to create a normal active geo cell in the multiple CPI map for Doppler filters -3, -2, -0, +0, +2, +3, and +/- 4. As soon as this many qualified target reports have occurred in the cell, a normal active geo cell is created, if it doesn't already exist. At the end of the block, if a cell has reached or exceeded this target count, the active block count of the cell is incremented. Default value is 2. (Section 5.2.1.4)

**GEO\_KILL\_CNT\_DOP2\_MCPI** Normal geo cell kill target count for multiple CPI geo map for Doppler filters -3, -2, -0, +0, +2, +3, and +/- 4. If at the end of a 512-scan block, a normal geo cell exists with a target count less than this parameter, the geo cell is deactivated (killed) and becomes a non-geo cell. Default value is 1, meaning that a normal geo cell is killed if its latest block saw 0 target reports. (Section 5.2.1.4)

**GEO\_EL\_BLK\_M\_DOP2\_MCPI** Number of active blocks (i.e., blocks with at least **GEO\_TGT\_CNT\_DOP2\_MCPI** target reports) required change a normal active geo cell to an active elephant geo cell for Doppler filters -3, -2, -0, +0, +2, +3, and +/- 4 in the multiple CPI geo map. This parameter is the “M” in an

“M out of N” block count requirement. The “N” parameter is **GEO\_EL\_BLK\_N\_DOP2\_MCPI**. As soon as “M” active blocks occur, a normal geo cell is changed to an elephant geo cell, even if the “N” total blocks have not yet been reached. Valid values range from 1 through 127. Default value is 10. (Section 5.2.1.4)

**GEO\_EL\_BLK\_N\_DOP2\_MCPI** Total number of blocks over which at least **GEO\_EL\_BLK\_M\_DOP2\_MCPI** must have satisfied the **GEO\_TGT\_CNT\_DOP2\_MCPI** target count requirement in order for a geo cell to be considered an elephant cell for Doppler filters -3, -2, -0, +0, +2, +3, and +/- 4 in the multiple CPI geo map. This parameter is the “N” in an “M out of N” block count requirement for elephant geo cell status. Valid values range from 1 through 127. Default value is 127. (Section 5.2.1.4)

**GEO\_EL\_ACT\_DOP2\_MCPI** Target count within a 512-scan block required to activate an inactive elephant geo cell for Doppler filters -3, -2, -0, +0, +2, +3, and +/- 4 in the multiple CPI geo map. As soon as this many qualified target reports have occurred in the cell, an inactive elephant geo cell is activated. Remember that only active geo cells can be used to censor target reports. Default is 1. (Section 5.2.1.4)

**GEO\_EL\_DEACT\_DOP2\_MCPI** Minimum target count within a 512-scan block required to maintain an active elephant geo cell for Doppler filters -3, -2, -0, +0, +2, +3, and +/- 4 in the multiple CPI geo map. If an active elephant geo cell has less than this number of qualified targets in a 512-scan block, the state of the cell is changed to inactive elephant. Remember that inactive geo cells cannot be used to censor target reports. Default is 1, meaning that 0 targets in a 512-scan block causes an elephant geo cell to be deactivated. (Section 5.2.1.4)

**GEO\_PERM\_PCT\_DOP2\_MCPI** Percentage of active to total blocks (i.e.  $100 * M/N$ ) required to promote elephant geo cells to permanent geo cell status for Doppler filters -3, -2, -0, +0, +2, +3, and +/- 4 in the multiple CPI geo map. When this ratio of active blocks to total blocks reaches this number, a geo cell is changed from elephant to permanent. When the ratio falls below this number, a permanent geo cell is changed to

elephant. Remember that permanent geo cells are always active – this cannot be disabled as long as they remain permanent. Valid values range from 1 to 100 percent. Default value is 5. (Section 5.2.1.4)

#### **GEO\_DECR\_SCPI**

Geo threshold decrement (dB) for one 512-scan block for the single CPI geocensor map. The 9PAC geo map cell thresholds are decremented once every 512 scans. In order to save CPU usage, each azimuth wedge has all of its cells decremented on the same scan, spread out throughout the scan. Therefore, in 512 scans, all 512 azimuth CPI wedges of the geo map are updated. Default is 1 dB. (Section 5.2.2)

#### **GEO\_BIAS\_SCPI**

Geo threshold bias (dB) for geo cells in the single CPI map. Note that this applies to cells that were not newly created within the current 512-scan block. This bias is added to the amplitude threshold of a geocensor cell when comparing a target amplitude with the threshold to determine radar confidence 0 or 1. Default value is 9 dB. (Section 5.2.3.2)

#### **GEO\_DEL\_CNT\_SCPI**

Single CPI geo map target density requirement for report deletion. An active geo cell (normal, elephant, or permanent) that reaches this number of qualified targets within a 512-scan block immediately is allowed to delete reports below the amplitude threshold of the geo cell for the remainder of the block. In addition, the geo cell is flagged so that it may delete all reports in the next block with amplitude below the deletion amplitude threshold, as defined by the parameter **GEO\_DEL\_THR\_MCPI** below. The value of this parameter may range from 0 to 7. Default is 0. (Section 5.2.3.2)

#### **GEO\_DEL\_THR\_SCPI**

Single CPI geo map target deletion amplitude threshold (dB). A geo cell that has satisfied the **GEO\_DEL\_CNT\_MCPI** target count parameter on the previous 512-scan block is allowed to delete all targets with amplitude this many dB below the geo cell's amplitude threshold. Note that only active geo cells (normal, elephant, or permanent) may censor target reports. The value of this parameter may range from 0 to 99 dB. Default is 0. (Section 5.2.3.2)

- GEO\_TGT\_CNT\_DOP1\_SCPI** Geo target count within a 512-scan block required to create a normal active geo cell in the single CPI map for Doppler filters -1 and +1. As soon as this many qualified target reports have occurred in the cell, a normal active geo cell is created, if it doesn't already exist. At the end of the block, if a cell has reached or exceeded this target count, the active block count of the cell is incremented. Default value is 2. (Section 5.2.1.4)
- GEO\_KILL\_CNT\_DOP1\_SCPI** Normal geo cell kill target count for single CPI geo map for Doppler filters -1 and +1. If at the end of a 512-scan block, a normal geo cell exists with a target count less than this parameter, the geo cell is deactivated (killed) and becomes a non-geo cell. Default value is 1, meaning that a normal geo cell is killed if its latest block saw 0 target reports. (Section 5.2.1.4)
- GEO\_EL\_BLK\_M\_DOP1\_SCPI** Number of active blocks (i.e., blocks with at least **GEO\_TGT\_CNT\_DOP1\_SCPI** target reports) required change a normal active geo cell to an active elephant geo cell for Doppler filters -1 and +1 in the single CPI geo map. This parameter is the "M" in an "M out of N" block count requirement. The "N" parameter is **GEO\_EL\_BLK\_N\_DOP1\_SCPI**. As soon as "M" active blocks occur, a normal geo cell is changed to an elephant geo cell, even if the "N" total blocks have not yet been reached. Valid values range from 1 through 127. Default value is 30. (Section 5.2.1.4)
- GEO\_EL\_BLK\_N\_DOP1\_SCPI** Total number of blocks over which at least **GEO\_EL\_BLK\_M\_DOP1\_SCPI** must have satisfied the **GEO\_TGT\_CNT\_DOP1\_SCPI** target count requirement in order for a geo cell to be considered an elephant cell for Doppler filters -1 and +1 in the single CPI geo map. This parameter is the "N" in an "M out of N" block count requirement for elephant geo cell status. Valid values range from 1 through 127. Default value is 127. (Section 5.2.1.4)

<b>GEO_EL_ACT_DOP1_SCPI</b>	Target count within a 512-scan block required to activate an inactive elephant geo cell for Doppler filters -1 and +1 in the single CPI geo map. As soon as this many qualified target reports have occurred in the cell, an inactive elephant geo cell is activated. Remember that only active geo cells can be used to censor target reports. Default is 1. (Section 5.2.1.4)
<b>GEO_EL_DEACT_DOP1_SCPI</b>	Minimum target count within a 512-scan block required to maintain an active elephant geo cell for Doppler filters -1 and +1 in the single CPI geo map. If an active elephant geo cell has less than this number of qualified targets in a 512-scan block, the state of the cell is changed to inactive elephant. Remember that inactive geo cells cannot be used to censor target reports. Default is 1, meaning that 0 targets in a 512-scan block causes an elephant geo cell to be deactivated. (Section 5.2.1.4)
<b>GEO_PERM_PCT_DOP1_SCPI</b>	Percentage of active to total blocks (i.e., $100 * M/N$ ) required to promote elephant geo cells to permanent geo cell status for Doppler filters -1 and +1 in the single CPI geo map. When this ratio of active blocks to total blocks reaches this number, a geo cell is changed from elephant to permanent. When the ratio falls below this number, a permanent geo cell is changed to elephant. Remember that permanent geo cells are always active - this cannot be disabled as long as they remain permanent. Valid values range from 1 to 100 percent. Default value is 35. (Section 5.2.1.4)
<b>GEO_TGT_CNT_DOP2_SCPI</b>	Geo target count within a 512-scan block required to create a normal active geo cell in the single CPI map for Doppler filters -3, -2, -0, +0, +2, +3, and +/- 4. As soon as this many qualified target reports have occurred in the cell, a normal active geo cell is created, if it doesn't already exist. At the end of the block, if a cell has reached or exceeded this target count, the active block count of the cell is incremented. Default value is 2. (Section 5.2.1.4)
<b>GEO_KILL_CNT_DOP2_SCPI</b>	Normal geo cell kill target count for single CPI geo map for Doppler filters -3, -2, -0, +0, +2, +3, and +/- 4. If at the end of a 512-scan block, a normal geo cell exists with a target

count less than this parameter, the geo cell is deactivated (killed) and becomes a non-geo cell. Default value is 1, meaning that a normal geo cell is killed if its latest block saw 0 target reports. (Section 5.2.1.4)

**GEO\_EL\_BLKMN\_DOP2\_SCPI** Number of active blocks (i.e., blocks with at least **GEO\_TGT\_CNT\_DOP2\_SCPI** target reports) required change a normal active geo cell to an active elephant geo cell for Doppler filters -3, -2, -0, +0, +2, +3, and +/- 4 in the single CPI geo map. This parameter is the “M” in an “M out of N” block count requirement. The “N” parameter is **GEO\_EL\_BLKMN\_DOP2\_SCPI**. As soon as “M” active blocks occur, a normal geo cell is changed to an elephant geo cell, even if the “N” total blocks have not yet been reached. Valid values range from 1 through 127. Default value is 10. (Section 5.2.1.4)

**GEO\_EL\_BLKNN\_DOP2\_SCPI** Total number of blocks over which at least **GEO\_EL\_BLKMN\_DOP2\_SCPI** must have satisfied the **GEO\_TGT\_CNT\_DOP2\_SCPI** target count requirement in order for a geo cell to be considered an elephant cell for Doppler filters -3, -2, -0, +0, +2, +3, and +/- 4 in the single CPI geo map. This parameter is the “N” in an “M out of N” block count requirement for elephant geo cell status. Valid values range from 1 through 127. Default value is 127. (Section 5.2.1.4)

**GEO\_EL\_ACT\_DOP2\_SCPI** Target count within a 512-scan block required to activate an inactive elephant geo cell for Doppler filters -3, -2, -0, +0, +2, +3, and +/- 4 in the single CPI geo map. As soon as this many qualified target reports have occurred in the cell, an inactive elephant geo cell is activated. Remember that only active geo cells can be used to censor target reports. Default is 1. (Section 5.2.1.4)

**GEO\_EL\_DEACT\_DOP2\_SCPI** Minimum target count within a 512-scan block required to maintain an active elephant geo cell for Doppler filters -3, -2, -0, +0, +2, +3, and +/- 4 in the single CPI geo map. If an active elephant geo cell has less than this number of qualified targets in a 512-scan block, the state of the cell is changed to inactive elephant. Remember that inactive geo cells cannot be used to censor target reports. Default is 1,

meaning that 0 targets in a 512-scan block causes an elephant geo cell to be deactivated. (Section 5.2.1.4)

**GEO\_PERM\_PCT\_DOP2\_SCPI** Percentage of active to total blocks (i.e.  $100 * M/N$ ) required to promote elephant geo cells to permanent geo cell status for Doppler filters -3, -2, -0, +0, +2, +3, and +/- 4 in the single CPI geo map. When this ratio of active blocks to total blocks reaches this number, a geo cell is changed from elephant to permanent. When the ratio falls below this number, a permanent geo cell is changed to elephant. Remember that permanent geo cells are always active – this cannot be disabled as long as they remain permanent. Valid values range from 1 to 100 percent. Default value is 5. (Section 5.2.1.4)

**GEO\_N\_MTI\_REGIONS** Number of MTI reflector regions. The maximum number of MTI regions is four. Most airports use one or two MTI reflectors positioned near the end of a runway (a known position on the radar scope) as a system confidence check. Default is 0. (Sections 4.2, 4.7, 5)

**GEO\_MTI\_REGIONS[4][4]** MTI reflector locations, specified in polar coordinates. These regions are very small and well defined, so they are specified in normal polar space. For each region, the four values are: (Sections 4.2, 4.7, 5)

R<sub>1</sub> Minimum range, in range gates (0-960)

A<sub>1</sub> Minimum azimuth, in ACP  
(the counter-clockwise 'edge')

R<sub>2</sub> Maximum range, in range gates (0-960)

A<sub>2</sub> Maximum azimuth, in ACP  
(the clockwise edge)

#### A.1.4 MISCELLANEOUS

##### WX\_CONTOUR\_THR

Nine-cell spatial filter threshold for contouring of weather data. If the number of WX detections in a 3x3 cell region reaches the threshold, then all nine cells are declared a detection; otherwise, all nine cells are filtered out. The default value is 5. At the range boundaries, where only six spatial cells are available, 2/3 of this number is used as the threshold. (Section 6)

##### ARTSIII\_QUAL\_TABLE[4][8]

ARTSIII Quality Table. This table provides a mechanism for converting the C&I quality, confidence values to the desired ARTSIII Quality values. While this table is used by 9PAC, it is required by the ARTS, so the 9PAC uses it to set the appropriate value in its target reports. The default settings for the table are shown below:

		Confidence							
		0	1	2	3	4	5	6	7
Quality	0	0	1	1	3	3	4	0	0
	1	0	2	0	5	4	5	0	0
	2	0	3	0	6	5	6	0	0
	3	0	4	0	7	6	7	0	0

##### TRK\_ELIG\_TABLE[4][8]

Track Eligibility Table. This table provides a mechanism for converting the C&I quality, confidence values to the ARTS tracker eligibility values used to determine eligibility for track initiation and association. Although the 9PAC Tracker has replaced this table with a set of scoring tables, also a function of quality and confidence, the eligibility field is a required target report attribute which must be filled in by 9PAC. There are two tables: one for reports with range below a threshold, and the other for reports with range above a threshold. The default settings for the two tables are shown below:



### Tracker Eligibility Table (range $\leq$ ADAPT\_THR\_RANGE)

		Confidence							
		0	1	2	3	4	5	6	7
Quality	0	0	0	0	3	3	1	0	0
	1	3	3	0	2	1	1	0	0
	2	3	3	0	2	2	1	0	0
	3	3	3	0	2	2	1	0	0

### Tracker Eligibility Table (range $>$ ADAPT\_THR\_RANGE)

		Confidence							
		0	1	2	3	4	5	6	7
Quality	0	0	0	0	3	3	3	0	0
	1	3	3	0	1	2	2	0	0
	2	3	3	0	1	2	2	0	0
	3	3	3	0	1	2	2	0	0

## A.2 ADAPTIVE THRESHOLDING AMPLITUDE EXCLUSION VSP MESSAGE

### ADAPT\_N\_FINE\_EXCL

Number of entries in the fine map amplitude exclusion table. This table provides a more fine-grained amplitude exclusion capability, which is applied to regions within the Fine Adaptive Threshold map. A maximum of 50 entries may be specified in the table. Default value is 0. (Section 5.3.2.1)

### ADAPT\_FINE\_EXCL[50][8]

Fine map amplitude exclusion table. This table provides a more fine-grained amplitude exclusion capability, designed to be applied to regions within the Fine Adaptive Threshold map. A maximum of 50 entries may be specified in the table. For each entry, a region is defined in the coordinates of the Fine Adaptive Threshold map, and a maximum amplitude is specified for four Doppler velocity bins:  $\pm 0$ ,  $\pm 1$ ,  $\pm 2$ , and  $\pm 3/\pm 4$ . Each cell in the Fine map has an azimuth resolution of 4-CPI and a range resolution of

1/2 nmi range. Thus, each entry specifies the following information: (Section 5.3.2.1)

A <sub>1</sub>	Minimum azimuth cell (0-127)
A <sub>e</sub>	Azimuth extent (0-15)
R <sub>1</sub>	Minimum range cell (0-119)
R <sub>e</sub>	Range extent (0-15)
T <sub>0</sub>	Maximum amplitude for Doppler $\pm 0$
T <sub>1</sub>	Maximum amplitude for Doppler $\pm 1$
T <sub>2</sub>	Maximum amplitude for Doppler $\pm 2$
T <sub>3</sub>	Maximum amplitude for Doppler $\pm 3/\pm 4$

### A.3 FIXED GEOSENSOR CELL TABLE VSP MESSAGE

#### GEO\_N\_FIXED

Number of entries in the Fixed Geo Cell table. This table provides the capability to hand-enter up to 100 fixed geocensor cells. Such cells are always active (like permanent geo cells). The amplitude threshold of “fixed” geo cells is adaptive, just like all geocensor cells. Default value is 0. (Section 5.2.1.4.5)

#### GEO\_FIXED[100][3]

Fixed Geo Cell table. This table provides the capability to hand-enter up to 100 fixed geocensor cells. Such cells are always active (like permanent geo cells). The amplitude threshold of “fixed” geo cells is adaptive, just like all geocensor cells. For each table entry, a region is defined in the range/azimuth coordinates of the Geocensor map, and a bit mask is built consisting of the selected Doppler filters classes to be treated as fixed geo cells: -3, -2, -1, -0, +0, +1, +2, +3,  $\pm 4$ . Note that each cell in the geocensor map has an azimuth resolution of 1-CPI and a range resolution of 1/16<sup>th</sup> nmi. Each entry specifies the following information: (Section 5.2.1.4.5)

A <sub>1</sub>	Minimum azimuth cell (0-511)
A <sub>e</sub>	Azimuth extent (0-15)
R <sub>1</sub>	Minimum range cell (0-960)
R <sub>e</sub>	Range extent (0-15)
D	Flag for Doppler filters

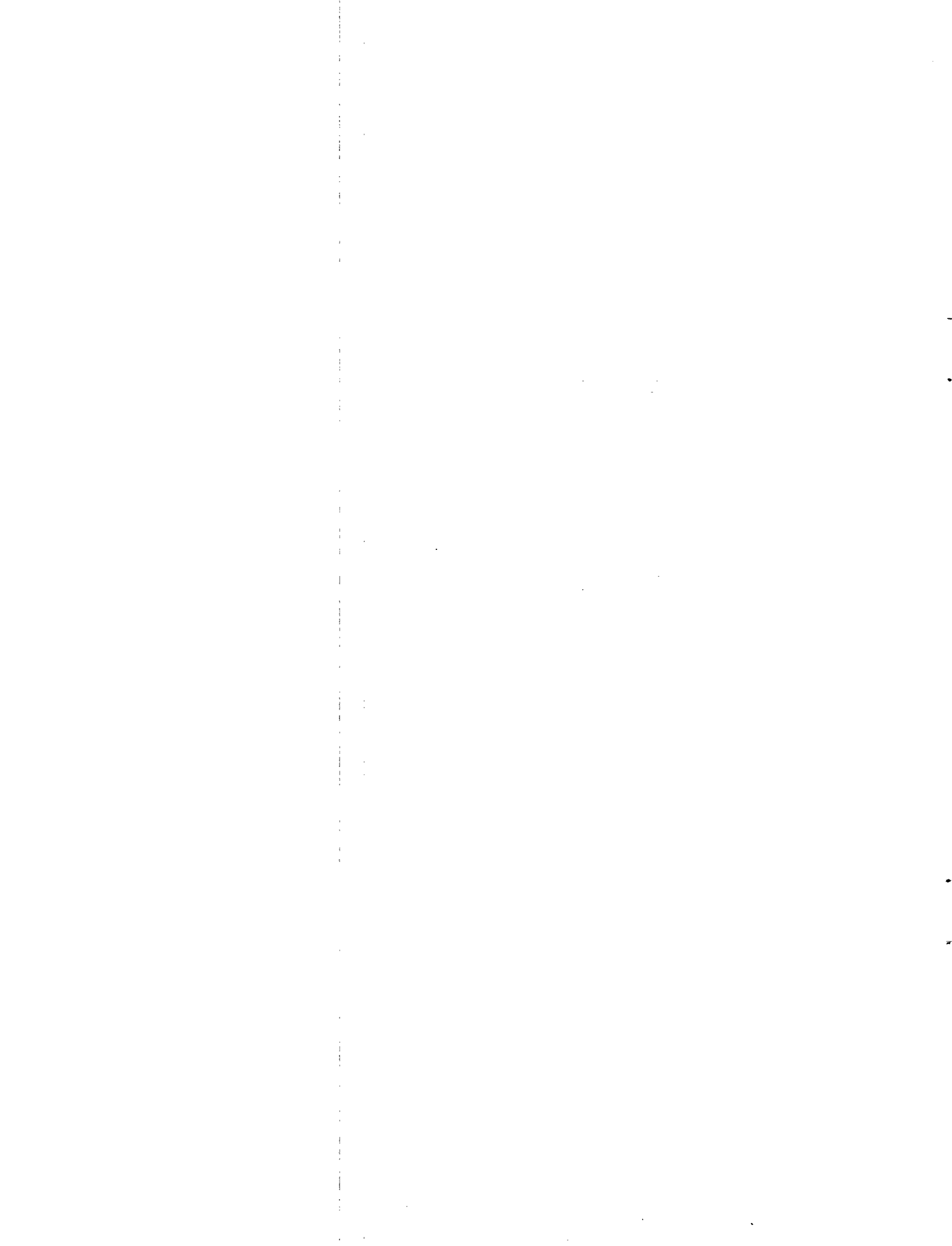

## APPENDIX B. PERFORMANCE MONITORING/ALARMS

Once per antenna scan, near north, the C&I task outputs performance counts and alarms. The 9PAC software combines this information with similar statistics from the BTM, MRG, and Tracker, and then makes this data available to the MIP.

The performance counts and alarms for C&I are presented in this appendix in the following categories: HSIB input counts; general counts; adaptive thresholding counts; geocensoring counts; and performance alarms. Most counts represent the values for the last full scan. However, there are some counts that are not reset each scan, such as geo cell counts and histograms. Counts that are preserved from scan to scan are identified. Alarms are set to 0 unless an alarm situation occurs.

### B.1 HSIB INPUT COUNTS

These performance counts provide information about the radar primitive data input to the C&I.

**Table B-1. HSIB Input Performance Counts**

Name	# Words	Description
AZ_HDR_ABSENT	1	Number of time-outs waiting for radar primitive azimuth headers. NOTE: This count is combined with the following 4 counts into a single CI_DATA_QUALITY word in the message sent to the MIP.
HDR_ABSENT	1	Number of time-outs waiting for any radar primitive headers.
INVALID_HDR	1	Number of invalid radar primitive headers.
AZ_BLOCK_MISMATCH	1	Number of azimuth block mismatches.
AZ_VARIANCE	1	Number of large changes in radar primitive azimuth data.
CI_XMTR_COASTS	1	Number of transmitter coasts in radar primitive data.
CI_ZVF_OVERLOADS	1	Number of ZVF overload in radar primitive data..
CI_ANTENNA_SPEEDUPS	1	Number of antenna speedups in radar primitive data.
CI_SATURATED_CELLS	1	Number of saturated cells in radar primitive data.
HI_WX_INPUTS	2	Number of high-level weather detections input to C&I.
LO_WX_INPUTS	2	Number of low-level weather detections input to C&I.
TOTAL_INPUT_COUNT	1	Total number of radar primitives input to C&I.
FILTER_INPUT_COUNT	10	Radar primitive histogram by Doppler filter.

## B.2 GENERAL PERFORMANCE COUNTS

**Table B-2. General C&I Performance Counts**

Name	# Words	Description
HI_WX_OUTPUTS	1	Number of contoured high-level weather declarations.
LO_WX_OUTPUTS	1	Number of contoured low-level weather declarations.
SUPP_RFI_FLAG	1	1 if supplemental RFI tag threshold reached; 0 otherwise.
SUPP_RFI_RPTS_DELETED	1	Number of reports deleted by supplemental RFI test.
RFI_RPTS_DELETED	1	Number of single CPI reports deleted by primary RFI test, which looks for "too many" filter responses.
MCPI_RPTS_BY_CONFIDENCE	8	Histogram of multiple CPI report counts by confidence. There are only 7 valid confidence values. The extra word is provided for future expansion.
SCPI_RPTS_BY_CONFIDENCE	8	Histogram of single CPI report counts by confidence. There are only 7 valid confidence values. The extra word is provided for future expansion.
RPTS_BY_QUALITY	4	Histogram of report counts by quality.
TOTAL_OUTPUT	1	Total number of reports output by C&I.
DELAYED_RPTS	1	Number of output reports that violated boresight delay requirements.
CENTROIDED_RPTS	1	Number of reports output by the C&I centroiding algorithm. These reports are then input to the adaptive geocensoring map.

### B.3 ADAPTIVE THRESHOLDING PERFORMANCE COUNTS

**Table B-3. Adaptive Thresholding Performance Counts (continued)**

Name	# Words	Description
ADAPT_VEL_EXCLUDED	1	Number of reports excluded from adaptive map thresholding because of ambiguous Doppler.
ADAPT_AMP_EXCLUDED	1	Number of reports excluded from adaptive map thresholding because of high amplitude.
ADAPT_EXCLUDED	1	Total number of reports excluded from adaptive map thresholding. This sum includes the above two counts, RTQC, and MTI reports.
ADAPT_MAP_INPUT	1	Number of reports input to adaptive map thresholding. This count is the sum of the following two counts.
ADAPT_MAP_NONGEO_INPUT	1	Number of non-geocensored reports input to adaptive map thresholding.
ADAPT_MAP_GEO_INPUT	1	Number of geocensored reports input to adaptive map thresholding.
ADAPT_PASSED	1	Number of reports that passed the adaptive map thresholding test.
ADAPT_DELETED	1	Number of reports deleted by the adaptive map thresholding test. This count is the sum of the following three counts.
ADAPT_FINE_DEL	1	Number of reports deleted by the multiple and single CPI Fine adaptive maps.
ADAPT_MEDIUM_DEL	1	Number of reports deleted by the multiple and single CPI Medium adaptive maps.
ADAPT_COARSE_DEL	1	Number of reports deleted by the multiple and single CPI Coarse adaptive maps.
ADAPT_FINE_SCPI_DEL	1	Number of reports deleted by the single CPI Fine adaptive map.
ADAPT_FINE_MCPI_DEL	1	Number of reports deleted by the multiple CPI Fine adaptive map.
ADAPT_MEDIUM_SCPI_DEL	1	Number of reports deleted by the single CPI Medium adaptive map.
ADAPT_MEDIUM_MCPI_DEL	1	Number of reports deleted by the multiple CPI Medium adaptive map.

**Table B-3. Adaptive Thresholding Performance Counts (concluded)**

Name	# Words	Description
ADAPT_COARSE_SCPI_DEL	1	Number of reports deleted by the single CPI Coarse adaptive map.
ADAPT_COARSE_MCPI_DEL	1	Number of reports deleted by the multiple CPI Coarse adaptive map.
ADAPT_BIRD_FLAGGED	1	Number of reports flagged by the Bird adaptive map.
ADAPT_BIRD_SCPI_FLAGGED	1	Number of single CPI reports flagged by the Bird adaptive map.
ADAPT_BIRD_MCPI_FLAGGED	1	Number of multiple CPI reports flagged by the Bird adaptive map.
ADAPT_FEEDBACK_RB	1	Number of radar-beacon reports used to correct the adaptive map threshold values, which were mistakenly raised prior to the Merge.
ADAPT_AVG_UNCORR_MCPI	1	Last 10-scan average uncorrelated multiple CPI report count measured in the uncorrelated feedback from the Tracker to the C&I. Only reports with confidence 3, 4, or 5 are used in computing the average. This is used in determining the threshold decrement value for multiple CPI Coarse and Bird adaptive maps.
ADAPT_AVG_UNCORR_SCPI	1	Last 10-scan average uncorrelated single CPI report count measured in the uncorrelated feedback from the Tracker to the C&I. Only reports with confidence 3, 4, or 5 are used in computing the average. This is used in determining the threshold decrement value for the single CPI Coarse adaptive map.
ADAPT_COARSE_DECR_MCPI	1	Current multiple CPI Coarse adaptive map decrement time (scans).
ADAPT_COARSE_DECR_SCPI	1	Current single CPI Coarse adaptive map decrement time (scans)
ADAPT_AVG_CORR	1	Last 10-scan average correlated report count measured in the correlated feedback from the Tracker to the C&I. Only reports with confidence 3, 4, or 5 are used. This is used for activating and deactivating the Bird Map.
ADAPT_BIRD_STATE	1	Bird Map state (0 through 5).
ADAPT_BIRD_ACTIVE	1	Is Bird Map active for thresholding? (0 or 1)
ADAPT_BIRD_DECR	1	Bird Map threshold decrement time (scans).

## B.4 GEOSENSOR PERFORMANCE COUNTS

The geocensor map performance counts are separated into three sub-groups: general counts, multiple CPI specific counts, and single CPI specific counts.

**Table B-4. General Geocensoring Performance Counts**

Name	# Words	Description
GEO_EXCLUDED	1	Total number of reports excluded from geocensor map thresholding. This count includes velocity exclusions, RTQC and MTI reports, and reports with a range $\geq 40$ nmi.
GEO_VEL_EXCLUDED	1	Number of reports excluded from geocensor map thresholding because of ambiguous Doppler. These reports are output with confidence 0 if within an active geo cell.
GEO_BELOW_THR	1	Confidence 0 reports not flagged for deletion by geocensor map. These targets are in active geocensor cells, and their amplitudes did not exceed the corresponding geocensor threshold. These targets did not satisfy the criteria for being flagged for deletion by the geocensor map, but they may be deleted subsequently by the adaptive map thresholding process.
GEO_ABOVE_THR	1	Confidence 1 report count at the output of the geocensor map. Note that these reports may be deleted subsequently by the adaptive map thresholding process.
GEO_DELETED	1	Total number of reports flagged for deletion by the geocensor map. Note that this count includes both multiple CPI and single CPI targets. Note that multiple CPI targets flagged for deletion are allowed to be output to the Merge, unless they are subsequently deleted by the adaptive map thresholding process.
GEO_NOT_IN_CELL	1	Number of reports eligible for geocensoring that were not located within an active geo map cell.



**Table B-5. Multiple CPI Geocensoring Performance Counts (continued)**

Name	# Words	Description
GEO_DELETED_MCPI	1	Number of multiple CPI reports flagged for deletion by the geocensor map. Note that these targets are passed to the adaptive map thresholding process, and if they are not deleted by the adaptive maps, they are output to the Merge.
GEO_COUNTED_MCPI	1	Number of multiple CPI reports that were used to update a geo map cell's target density count. Note that this count is the sum of GEO_COUNTED_DEL_MCPI and GEO_COUNTED_OUT_MCPI.
GEO_COUNTED_DEL_MCPI	1	Number of multiple CPI reports deleted by the adaptive maps that were used to update a geo map cell's target density count.
GEO_COUNTED_OUT_MCPI	1	Number of multiple CPI reports sent by C&I to the Merge, remained uncorrelated, and were subsequently used to update a geo map cell's target density count because they were not merged with a beacon or correlated by the Tracker.
GEO_RPTS_MCPI	1	Total number of multiple CPI reports within active geocensor map cells.
GEO_RPTS_HISTO_MCPI	9	Histogram by Doppler filter class (-3, -2, -1, -0, +0, +1, +2, +3, ±4) of the multiple CPI reports within active geocensor map cells.
GEO_ABOVE_MCPI	1	Total number of confidence 1 multiple CPI reports within active geocensor map cells.
GEO_ABOVE_HISTO_MCPI	9	Histogram by Doppler filter class (-3, -2, -1, -0, +0, +1, +2, +3, ±4) of the confidence 1 multiple CPI reports.
GEO_CELLS_MCPI	1	Total number of cells in the multiple CPI geo map that have reached the NORMAL ACTIVE, ELEPHANT, or PERMANENT type. This count is preserved from scan to scan.
GEO_CELLS_HISTO_MCPI	9	Histogram by Doppler filter class (-3, -2, -1, -0, +0, +1, +2, +3, ±4) of the multiple CPI geo map cells that have reached the NORMAL ACTIVE, ELEPHANT, or PERMANENT type. These counts are preserved from scan to scan.

**Table B-5. Multiple CPI Geocensing Performance Counts (concluded)**

Name	# Words	Description
GEO_NORM_MCPI	1	Total number of NORMAL ACTIVE multiple CPI geo map cells. This count is preserved from scan to scan.
GEO_NORM_HISTO_MCPI	9	Histogram by Doppler filter class (-3, -2, -1, -0, +0, +1, +2, +3, ±4) of NORMAL ACTIVE multiple CPI geo map cells. These counts are preserved from scan to scan.
GEO_ELEPH_MCPI	1	Total number of ELEPHANT multiple CPI geo map cells. This count is preserved from scan to scan.
GEO_ELEPH_HISTO_MCPI	9	Histogram by Doppler filter class (-3, -2, -1, -0, +0, +1, +2, +3, ±4) of ELEPHANT multiple CPI geo map cells. These counts are preserved from scan to scan.
GEO_ACT_ELEPH_MCPI	1	Total number of ACTIVE ELEPHANT multiple CPI geo map cells. This count is preserved from scan to scan.
GEO_ACT_ELEPH_HISTO_MCPI	9	Histogram by Doppler filter class (-3, -2, -1, -0, +0, +1, +2, +3, ±4) of ACTIVE ELEPHANT multiple CPI geo map cells. These counts are preserved from scan to scan.
GEO_PERM_MCPI	1	Total number of PERMANENT multiple CPI geo map cells. This count is preserved from scan to scan.
GEO_PERM_HISTO_MCPI	9	Histogram by Doppler filter class (-3, -2, -1, -0, +0, +1, +2, +3, ±4) of PERMANENT multiple CPI geo map cells. These counts are preserved from scan to scan.

**Table B-6. Single CPI Geocensoring Performance Counts (continued)**

Name	# Words	Description
GEO_DELETED_SCPI	1	Number of single CPI reports deleted by the geocensor map. Note that these targets are NOT passed to the adaptive map thresholding process.
GEO_COUNTED_SCPI	1	Number of single CPI reports that were used to update a geo map cell's target density count. Note that this count is the sum of GEO_COUNTED_DEL_SCPI and GEO_COUNTED_OUT_SCPI.
GEO_COUNTED_DEL_SCPI	1	Number of single CPI reports deleted by the geo map or adaptive maps that were used to update a geo map cell's target density count.
GEO_COUNTED_OUT_SCPI	1	Number of single CPI reports sent by C&I to the Merge, remained uncorrelated, and were subsequently used to update a geo map cell's target density count because they were not merged with a beacon or correlated by the Tracker.
GEO_RPTS_SCPI	1	Total number of single CPI reports within active geocensor map cells.
GEO_RPTS_HISTO_SCPI	9	Histogram by Doppler filter class (-3, -2, -1, -0, +0, +1, +2, +3, ±4) of the single CPI reports within active geocensor map cells.
GEO_ABOVE_SCPI	1	Total number of confidence 1 single CPI reports within active geocensor map cells.
GEO_ABOVE_HISTO_SCPI	9	Histogram by Doppler filter class (-3, -2, -1, -0, +0, +1, +2, +3, ±4) of the confidence 1 single CPI reports.
GEO_CELLS_SCPI	1	Total number of cells in the single CPI geo map that have reached the NORMAL ACTIVE, ELEPHANT, or PERMANENT type. This count is preserved from scan to scan.
GEO_CELLS_HISTO_SCPI	9	Histogram by Doppler filter class (-3, -2, -1, -0, +0, +1, +2, +3, ±4) of the single CPI geo map cells that have reached the NORMAL ACTIVE, ELEPHANT, or PERMANENT type. These counts are preserved from scan to scan.

**Table B-6. Single CPI Geocensoring Performance Counts (concluded)**

Name	# Words	Description
GEO_NORM_SCPI	1	Total number of NORMAL ACTIVE single CPI geo map cells. This count is preserved from scan to scan.
GEO_NORM_HISTO_SCPI	9	Histogram by Doppler filter class (-3, -2, -1, -0, +0, +1, +2, +3, ±4) of NORMAL ACTIVE single CPI geo map cells. These counts are preserved from scan to scan.
GEO_ELEPH_SCPI	1	Total number of ELEPHANT single CPI geo map cells. This count is preserved from scan to scan.
GEO_ELEPH_HISTO_SCPI	9	Histogram by Doppler filter class (-3, -2, -1, -0, +0, +1, +2, +3, ±4) of ELEPHANT single CPI geo map cells. These counts are preserved from scan to scan.
GEO_ACT_ELEPH_SCPI	1	Total number of ACTIVE ELEPHANT single CPI geo map cells. This count is preserved from scan to scan.
GEO_ACT_ELEPH_HISTO_SCPI	9	Histogram by Doppler filter class (-3, -2, -1, -0, +0, +1, +2, +3, ±4) of ACTIVE ELEPHANT single CPI geo map cells. These counts are preserved from scan to scan.
GEO_PERM_SCPI	1	Total number of PERMANENT single CPI geo map cells. This count is preserved from scan to scan.
GEO_PERM_HISTO_SCPI	9	Histogram by Doppler filter class (-3, -2, -1, -0, +0, +1, +2, +3, ±4) of PERMANENT single CPI geo map cells. These counts are preserved from scan to scan.

## B.5 PERFORMANCE ALARMS

C&I outputs performance alarms to indicate certain anomalous conditions that may warrant notification of FAA personnel.

**Table B-7. Performance Alarms**

Name	# Words	Description
CI_INPUT_OVERLOAD	1	C&I CPI-Pair overload alarm.
CI_RPT_OVERLOAD	1	C&I report list overload alarm.
CI_INTERFERENCE	1	C&I Supplemental RFI interference alarm is set if the C&I VSP SUPP_RFI_DEL_THR condition is satisfied.
CI_LATE	1	C&I range reduction alarm is triggered when too many late targets are seen by C&I just before it outputs reports to the Merge. Currently, C&I is looking for more than 4 targets with boresight delay exceeding 152 ACPs (i.e., within 24 ACP of the Merge time window VSP's nominal value).
FLASH_GEO_MCPI	2	C&I flash card read/write error alarms for multiple CPI geocensor map. C&I maintains a separate alarm word for each of the two flash card copies of this map. These alarms are combined into a single FLASH_ERR alarm before alarms are sent to the MIP.
FLASH_GEO_SCPI	2	C&I flash card read/write error alarms for single CPI geocensor map. C&I maintains a separate alarm word for each of the two flash card copies of this map. These alarms are combined into a single FLASH_ERR alarm before alarms are sent to the MIP.

## APPENDIX C. C&I STATE AND DATA FLOW DIAGRAMS

A top-level block diagram of the 9PAC C&I is shown in Figure C-1. Detailed flowcharts of all major components are shown in Figures C-2 through C-51.

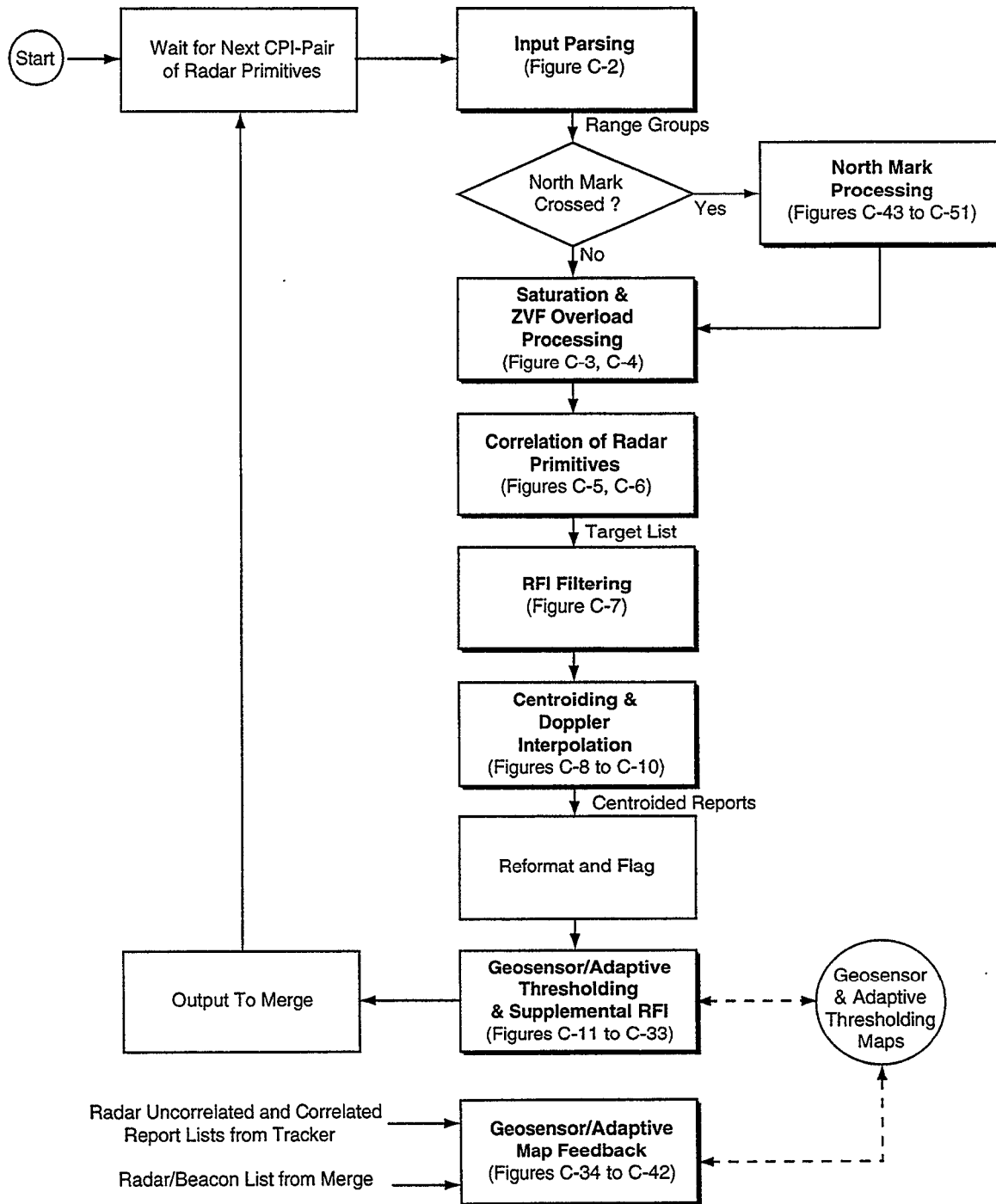

*Figure C-1. C&I processing top level block diagram.*

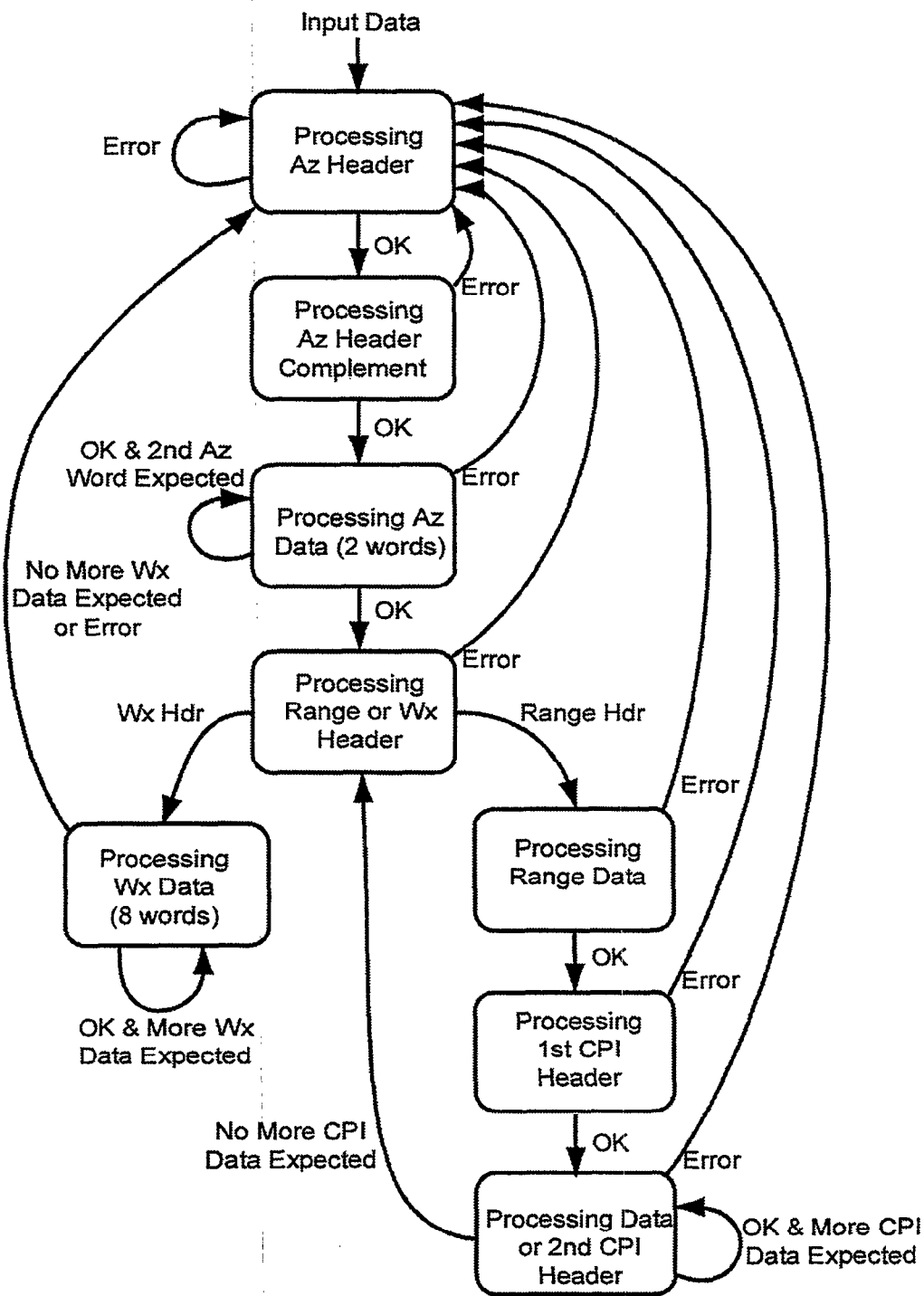

Figure C-2. Input parsing state transition diagram.

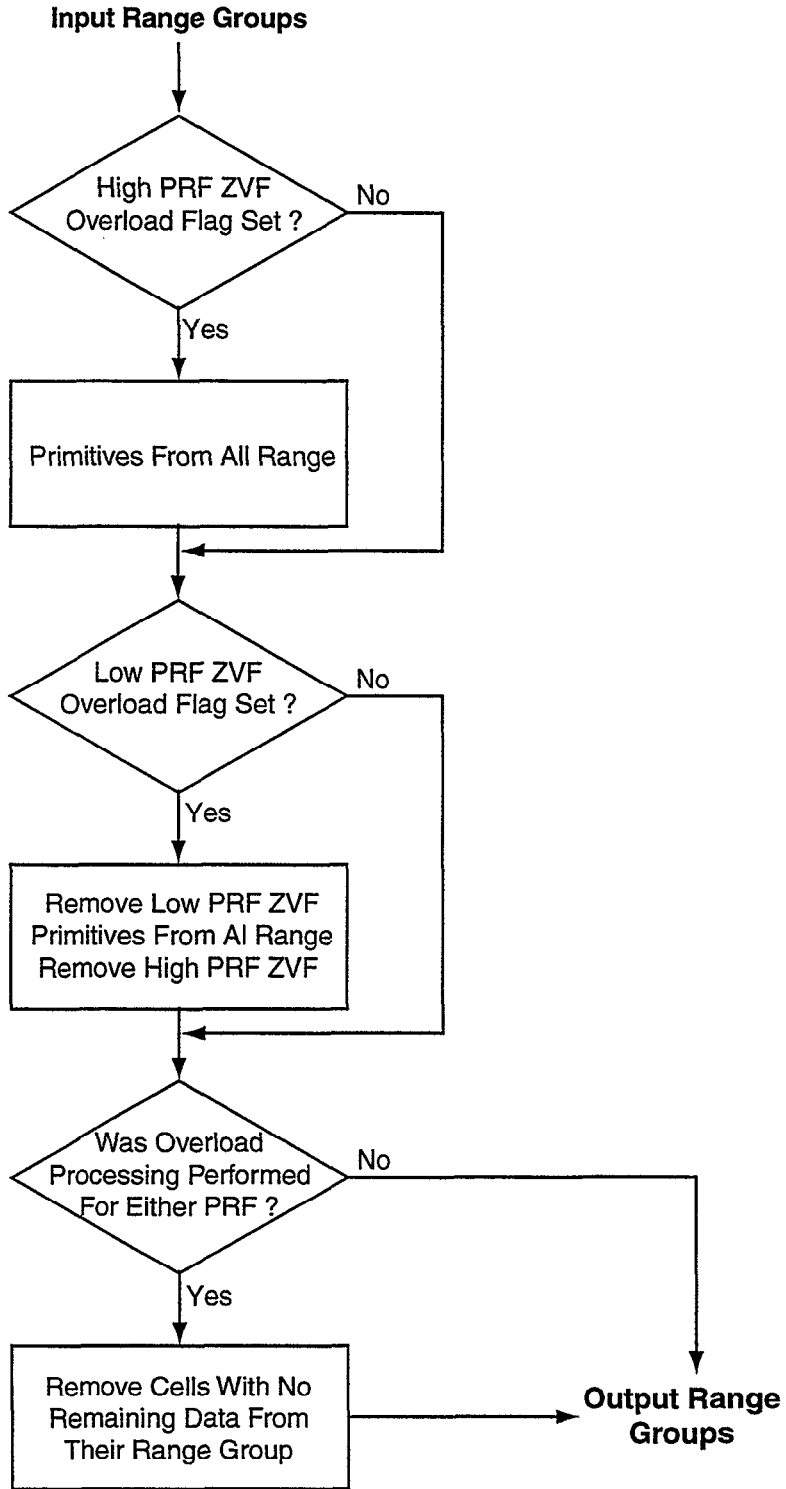

Figure C-3. ZVF overload processing.



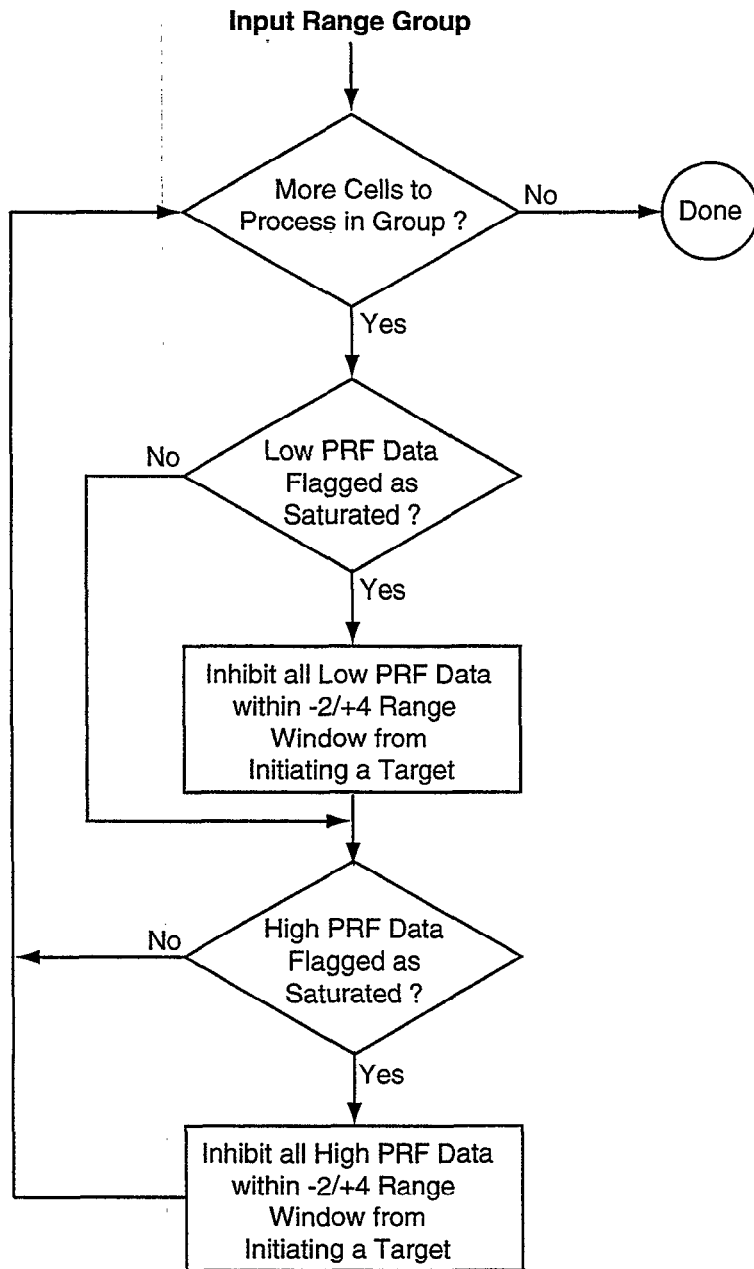

Figure C-4. Saturation preprocessing.

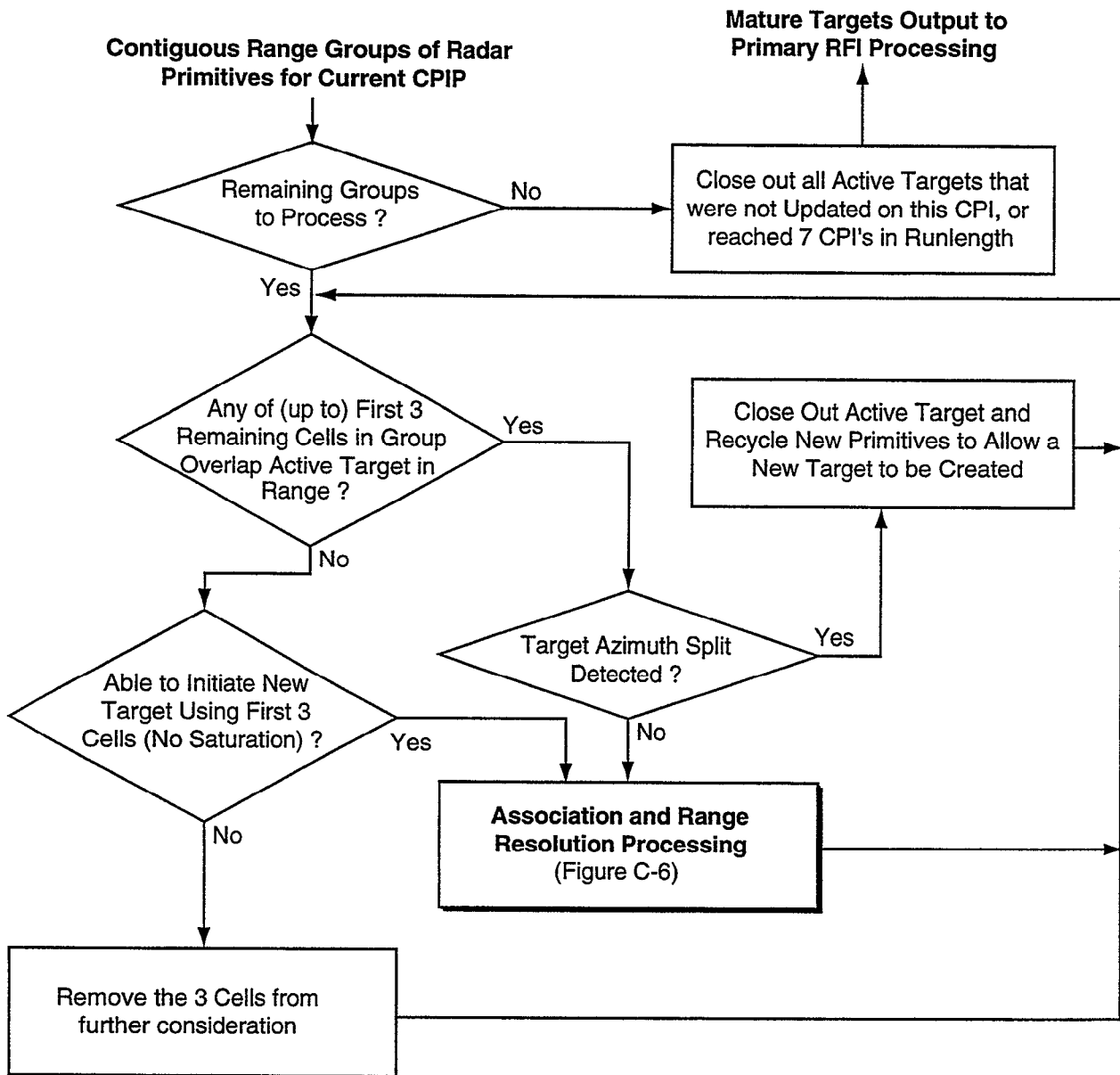

Figure C-5. Target correlation.

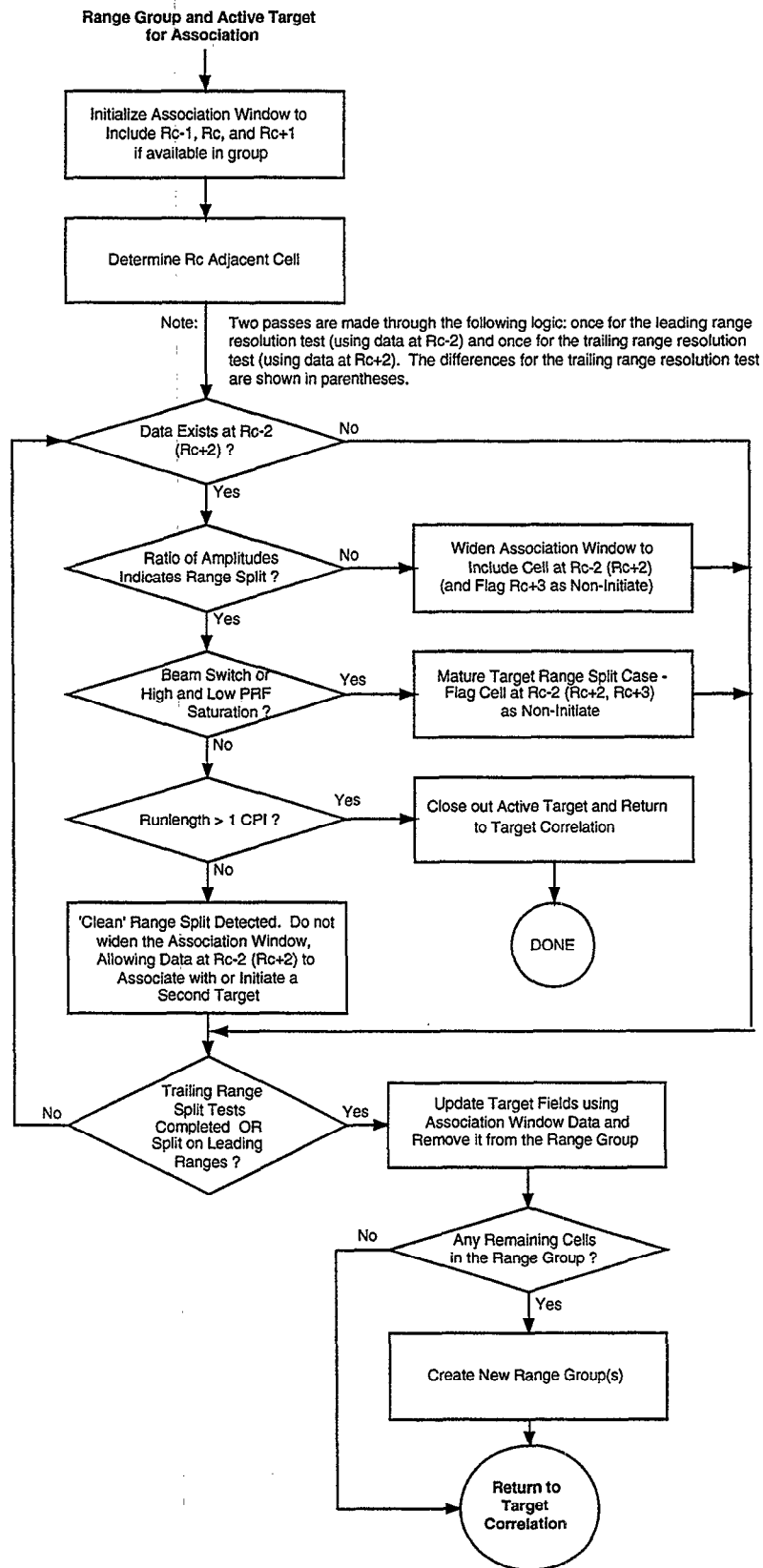
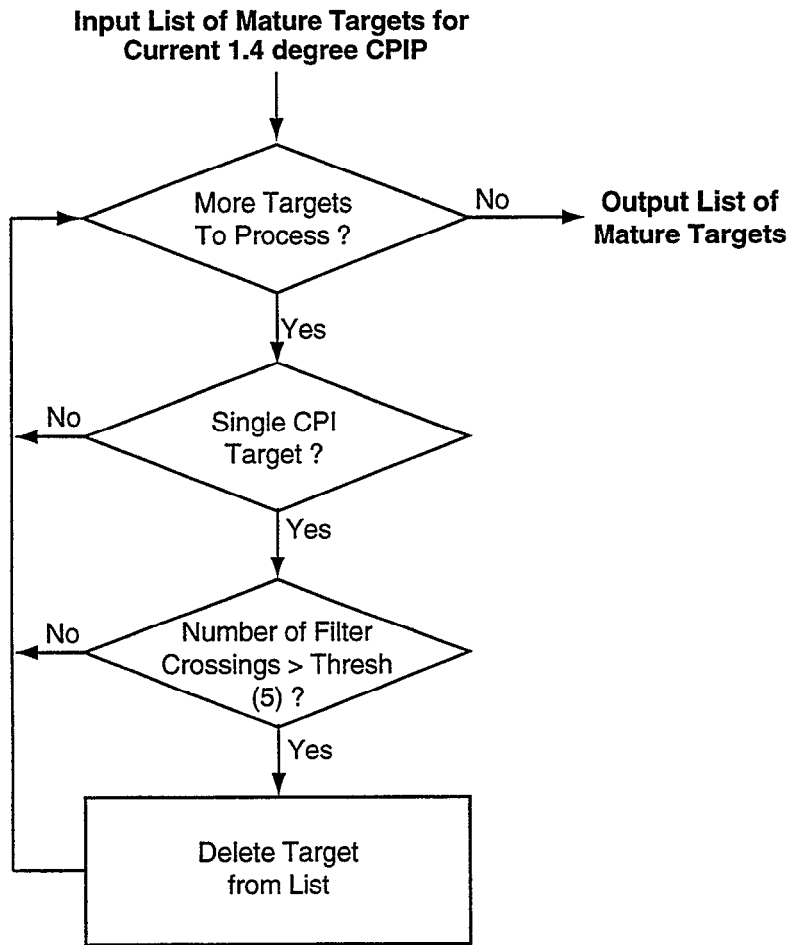

Figure C-6. Association and range resolution processing.



*Figure C-7. Primary RFI processing.*

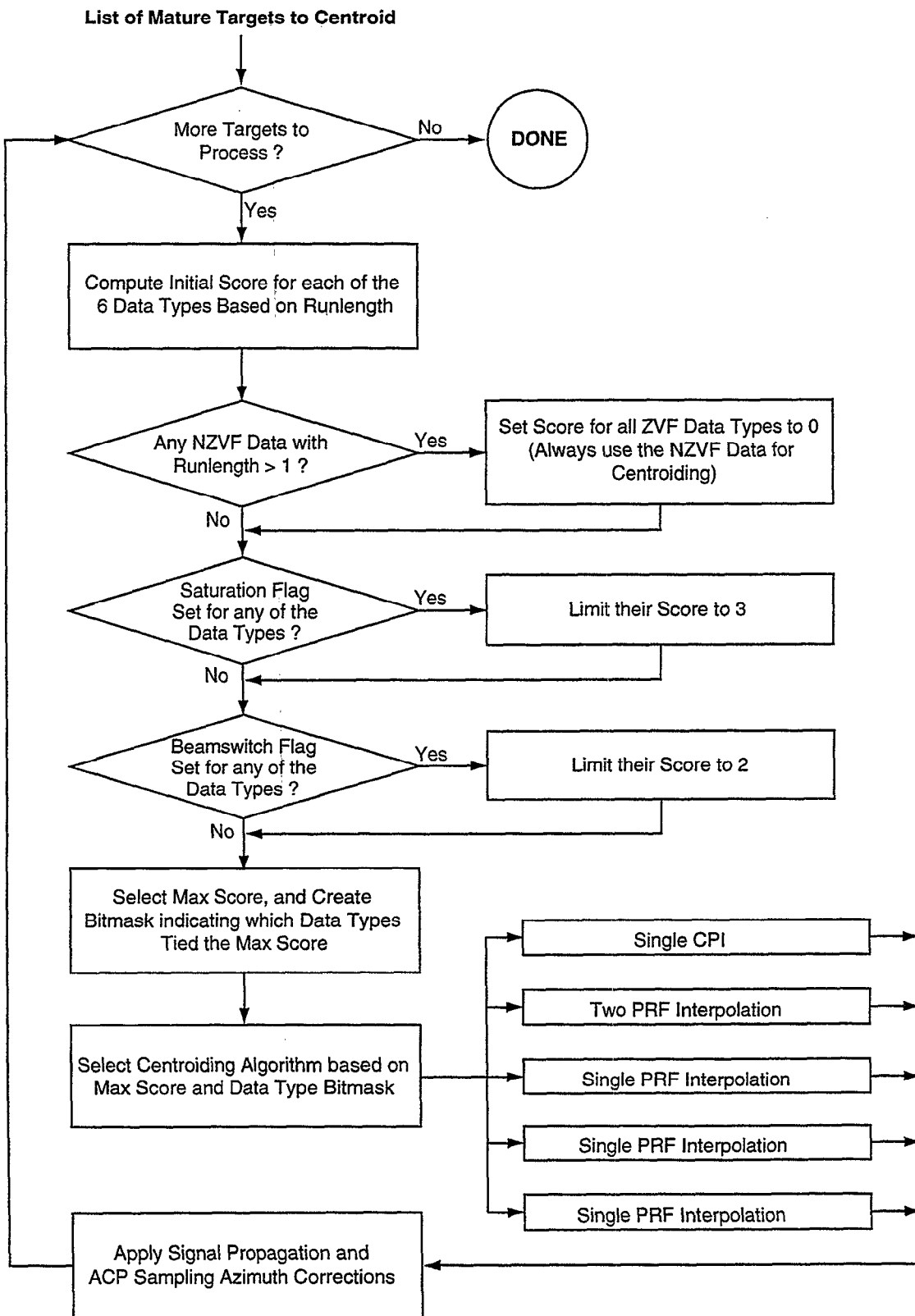

Figure C-8. Azimuth centroiding.

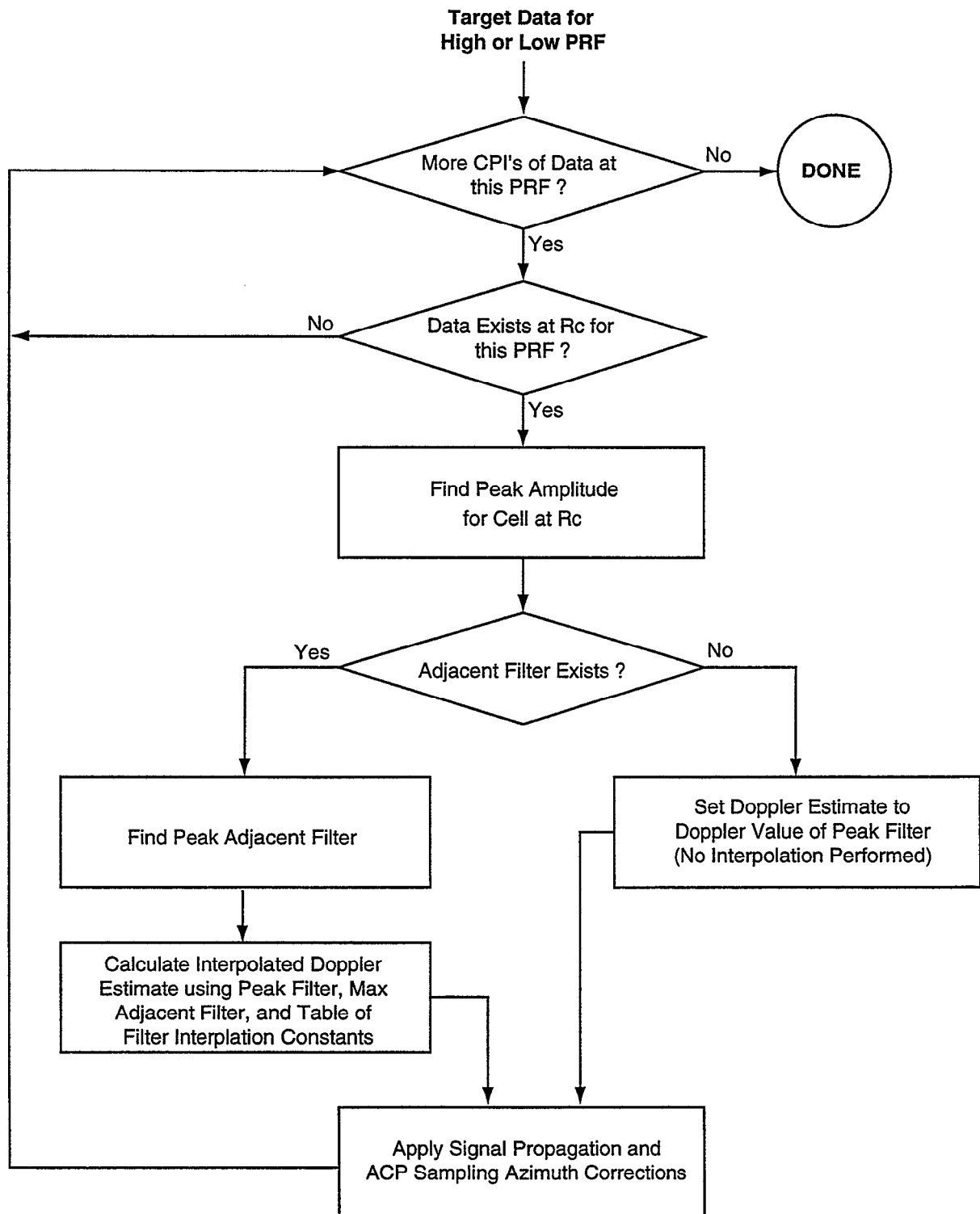

Figure C-9. Doppler interpolation.

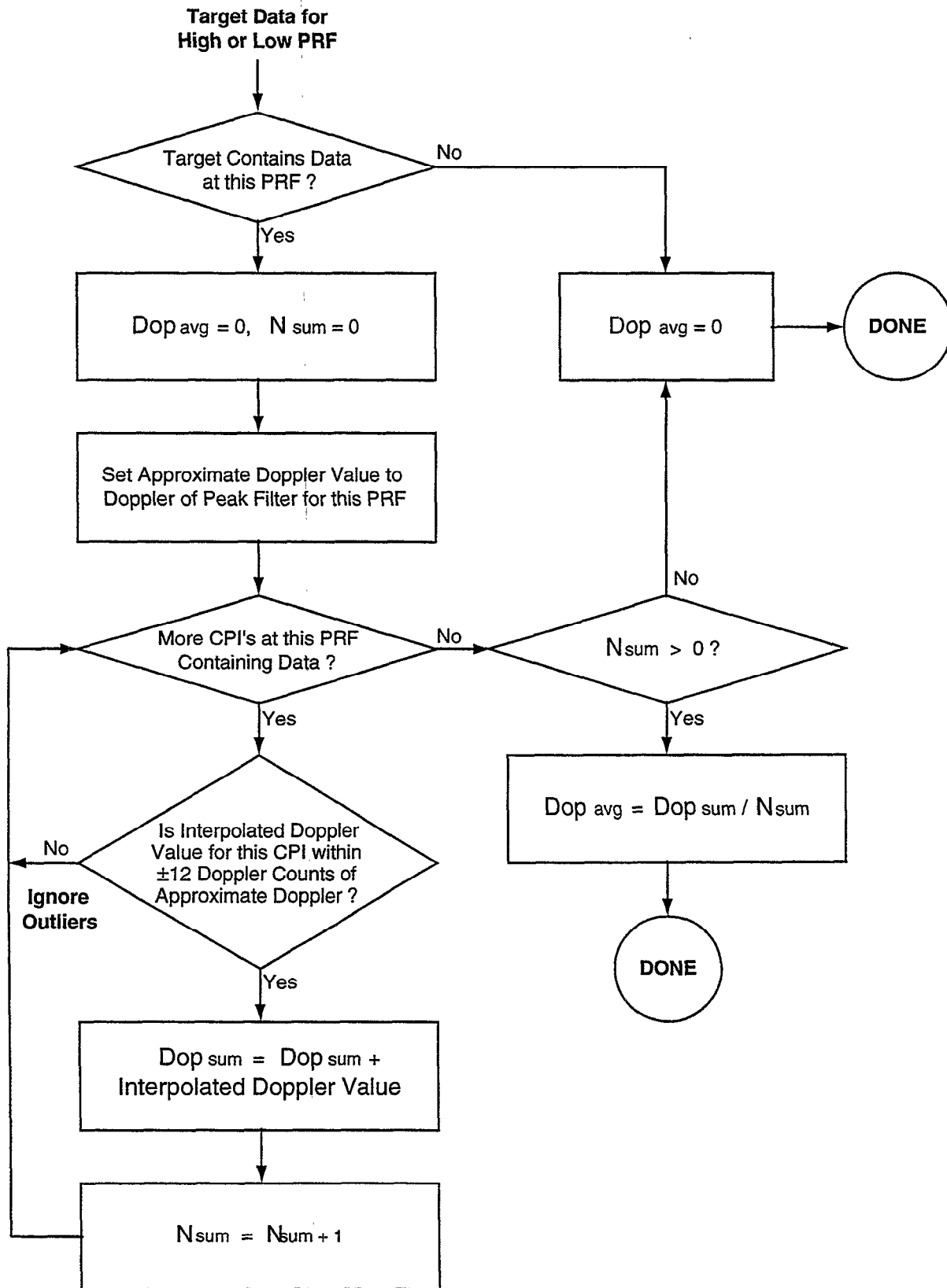

Figure C-10. Doppler smoothing.

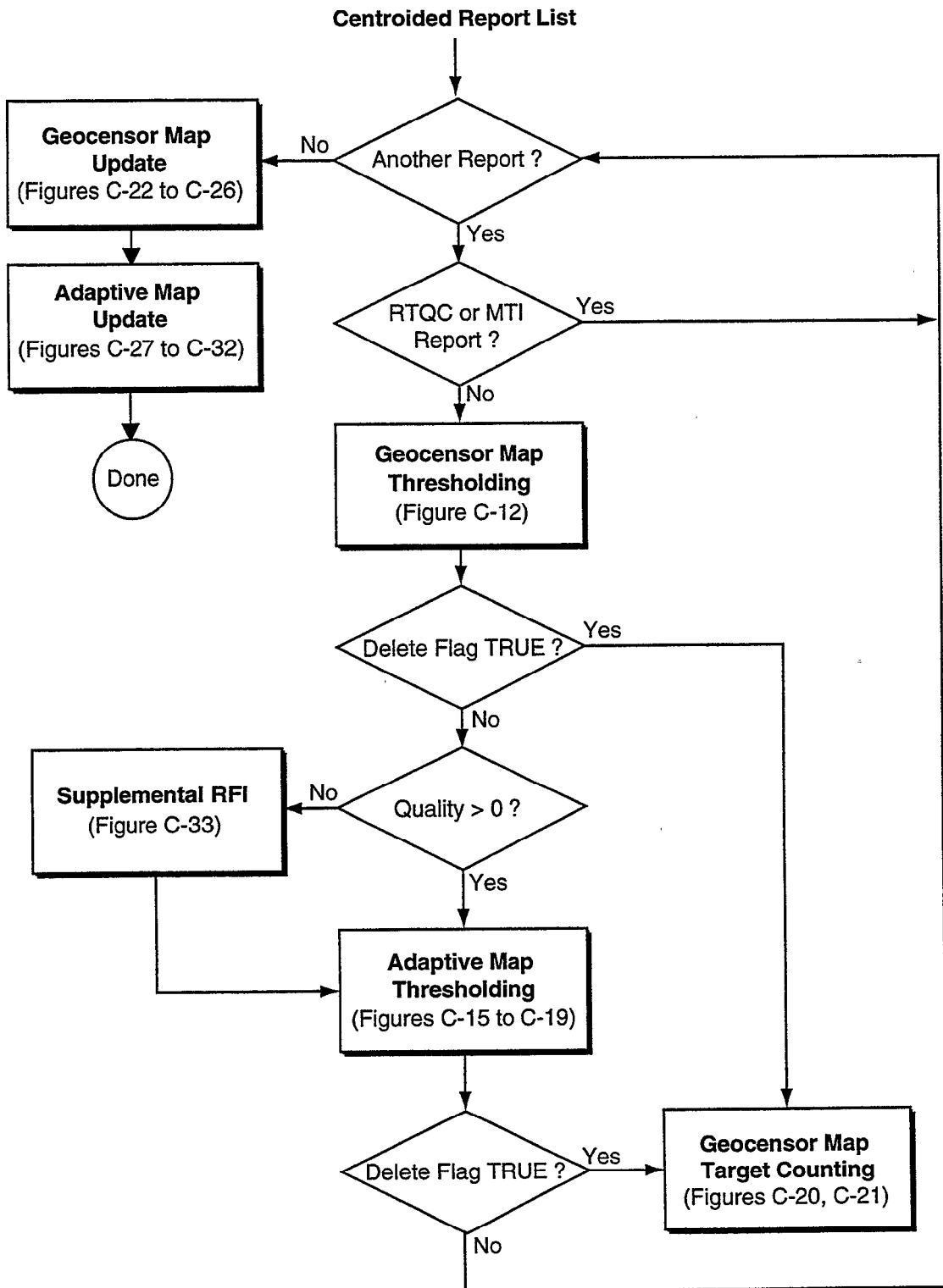

Figure C-11. Geocensor and adaptive map processing.



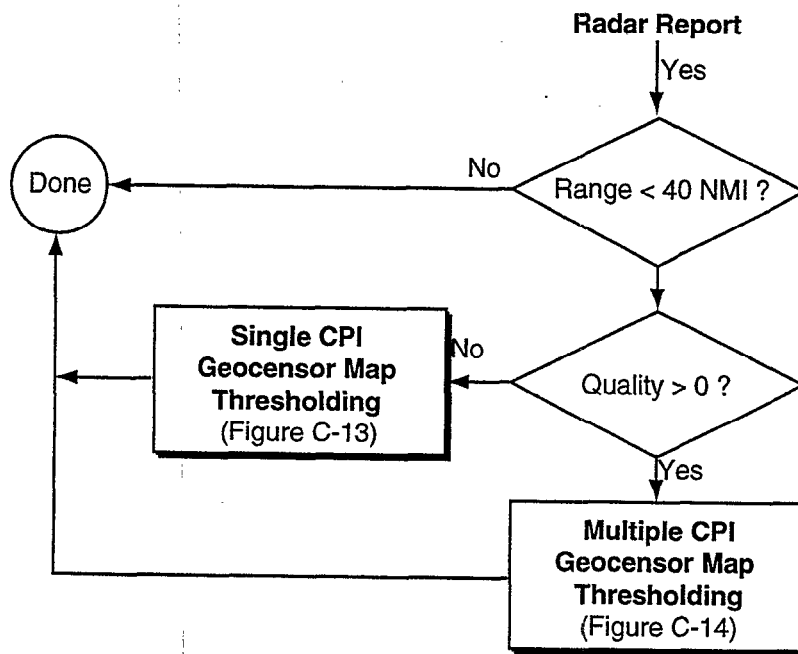

Figure C-12. Geocensor map thresholding.

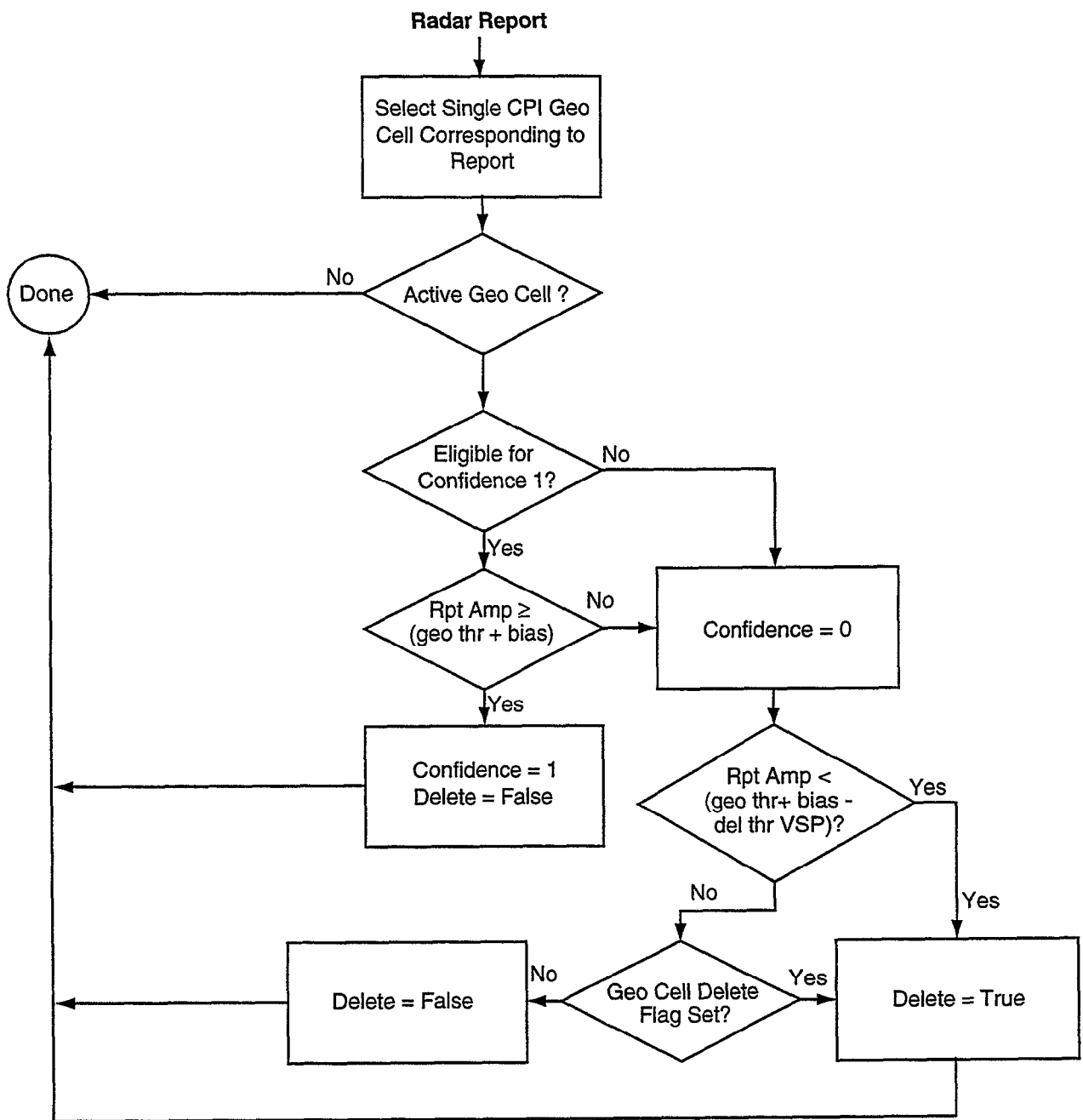
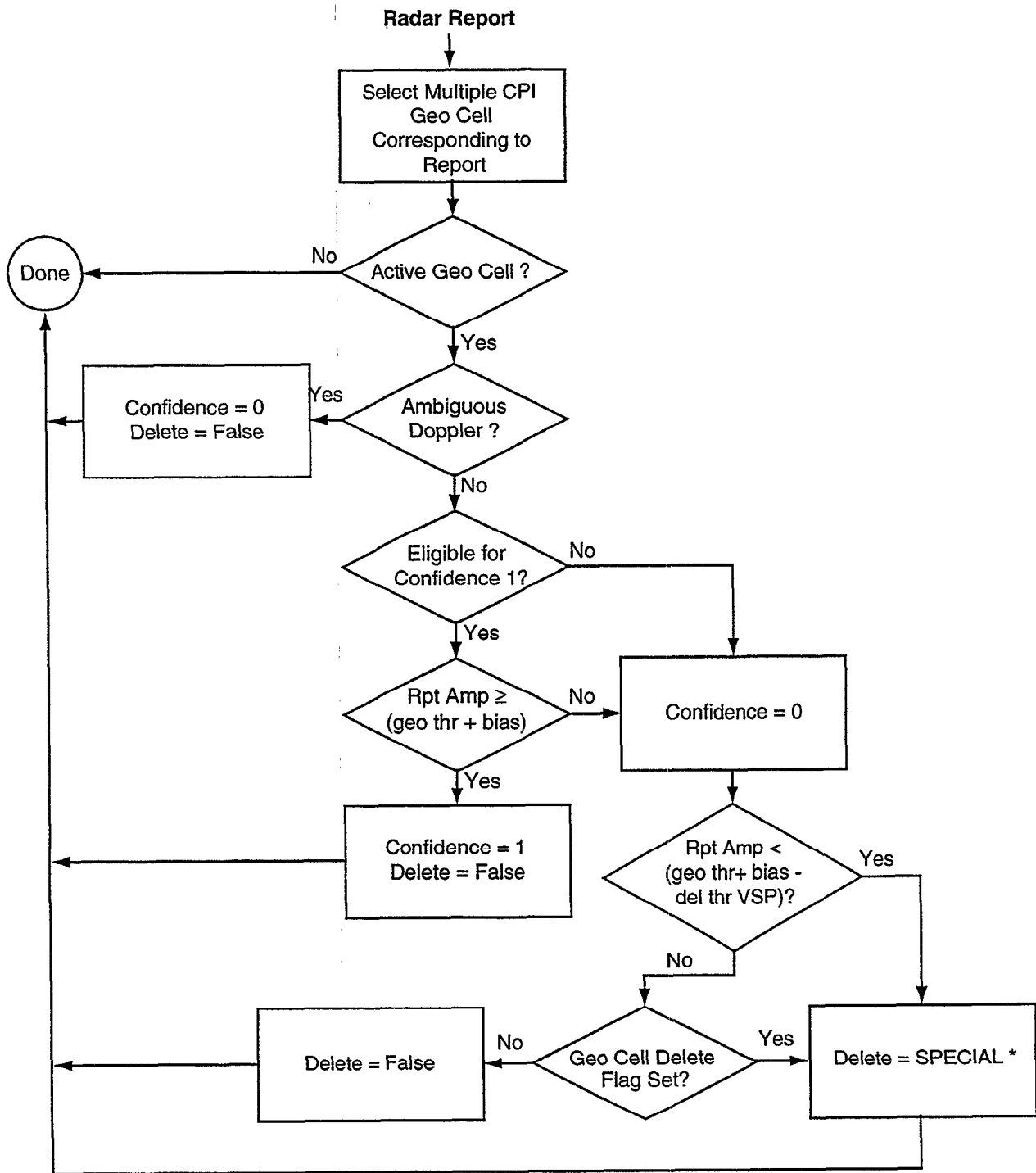

Figure C-13. Single CPI geocensor map thresholding.



\* NOTE: Instead of deleting reports, the Multiple CPI Geocensor Map outputs them with a flag for special processing. If such reports fail to merge with a beacon report, the resulting uncorrelated radar reports are only used by the 9-PAC Tracker to update existing beacon tracks.

Figure C-14. Multiple CPI geocensor map thresholding.

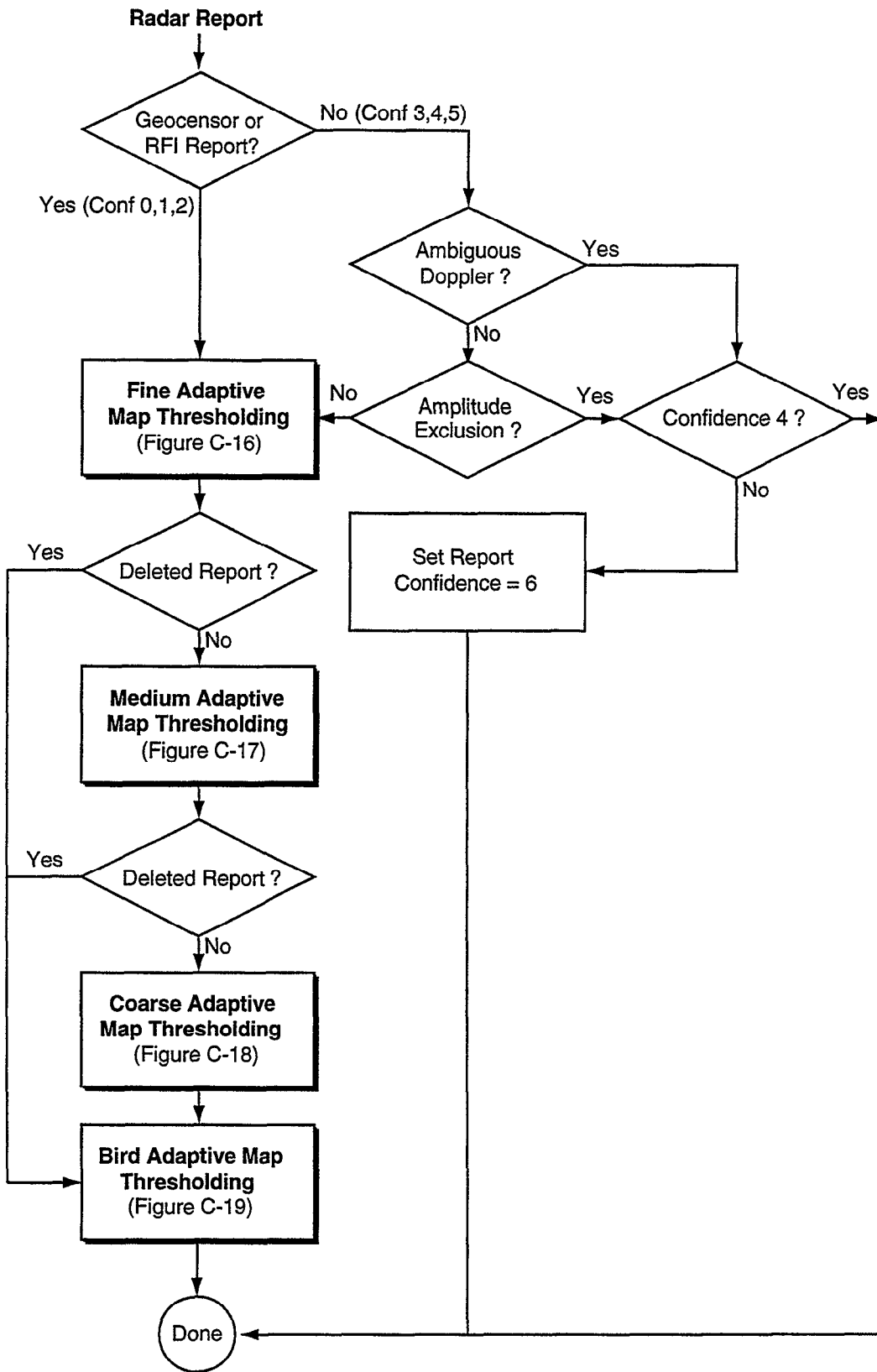

Figure C-15. Adaptive map thresholding.

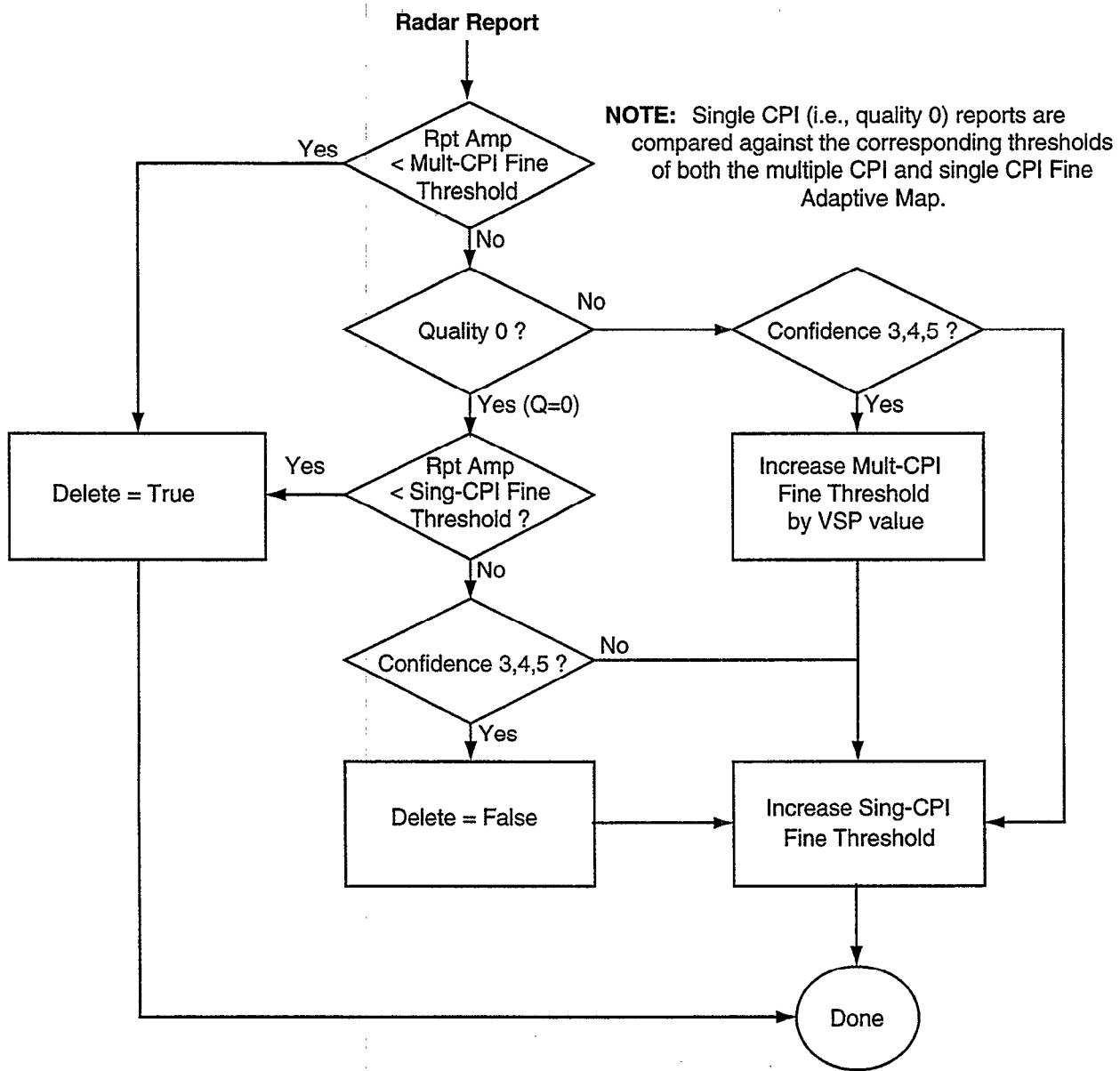

Figure C-16. Fine adaptive map thresholding.

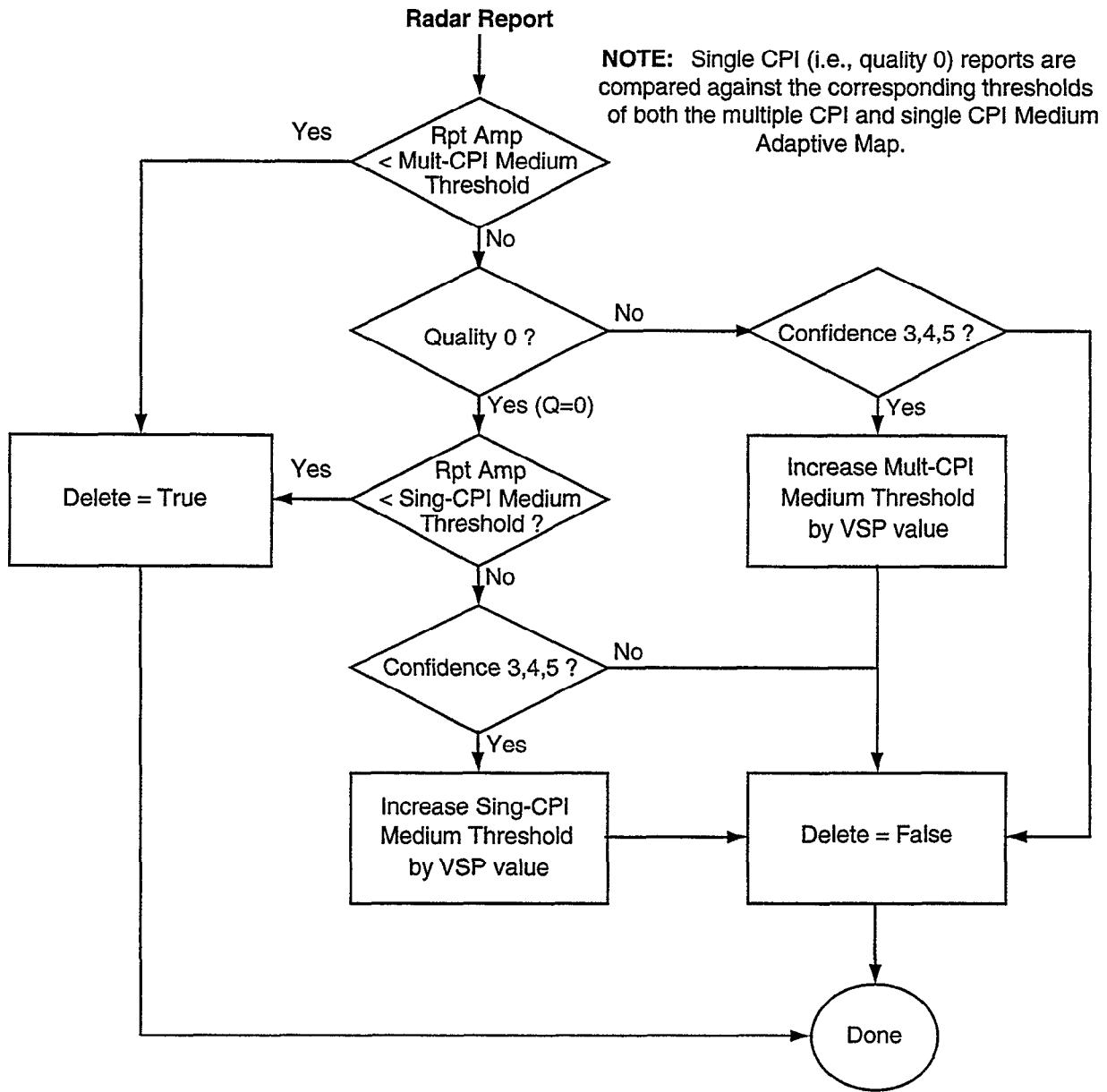

Figure C-17. Medium adaptive map thresholding.

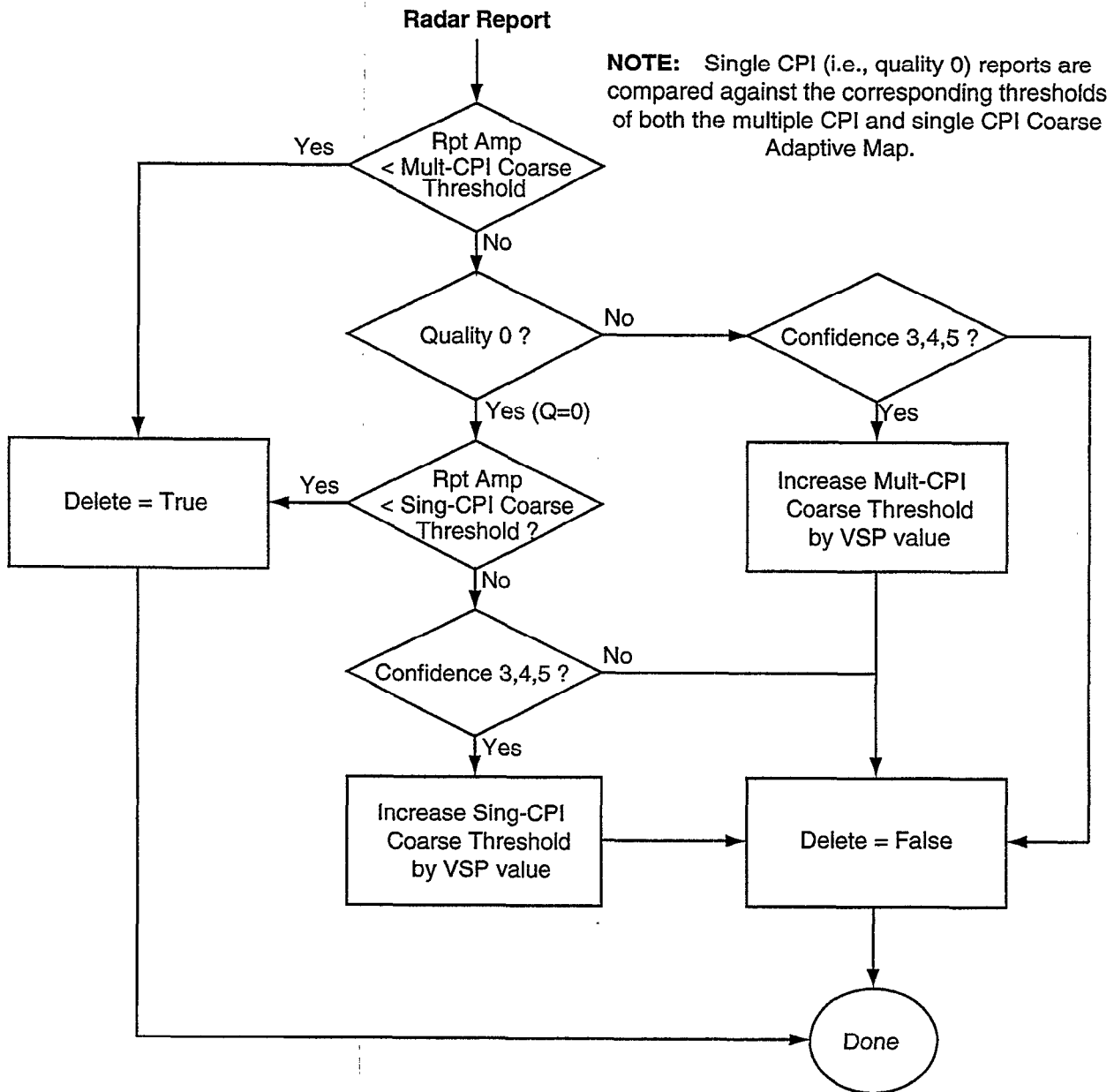

Figure C-18. Coarse adaptive map thresholding.

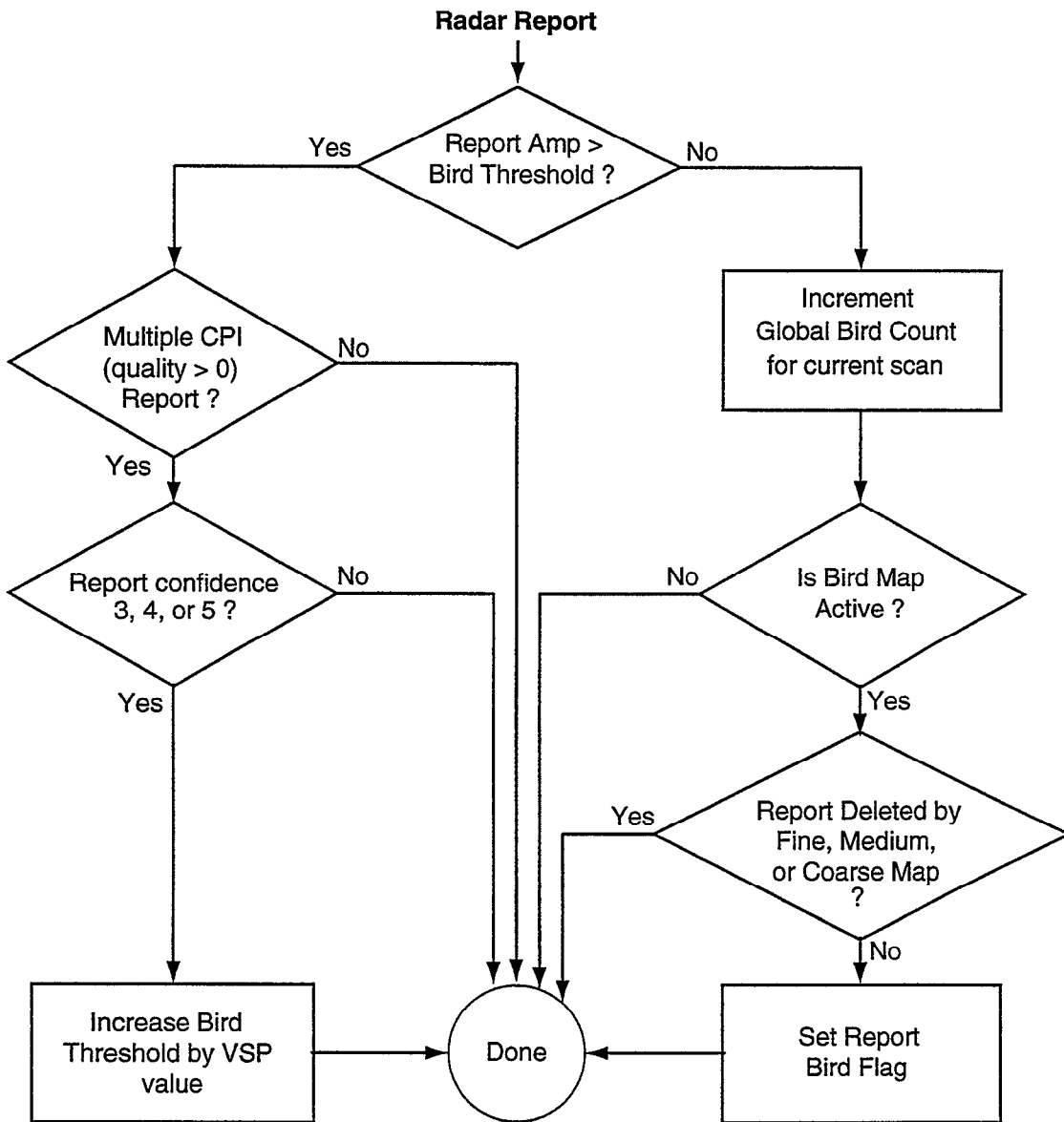

Figure C-19. Bird adaptive map thresholding.



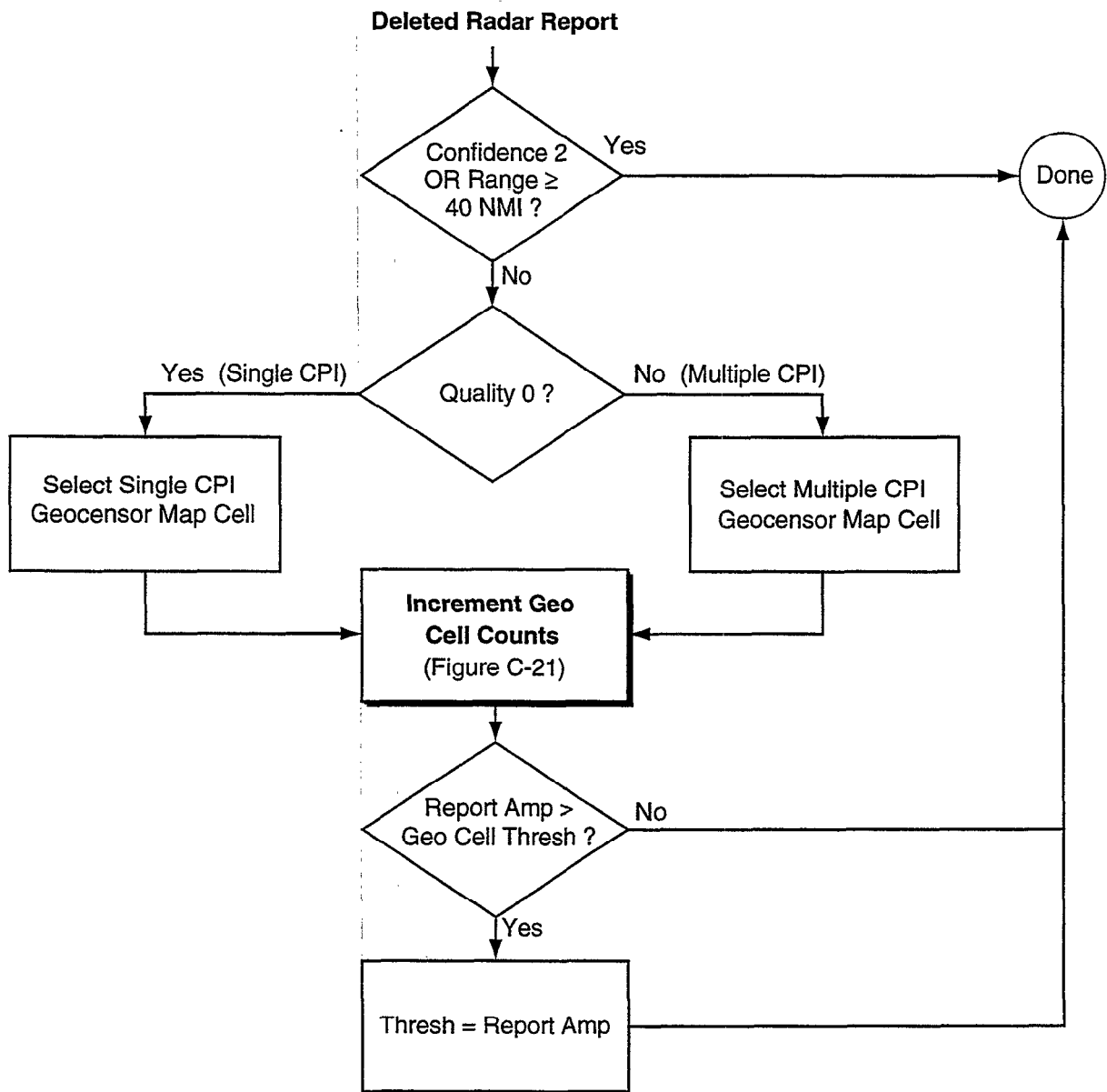

Figure C-20. Geocensor map report counting for deleted reports.

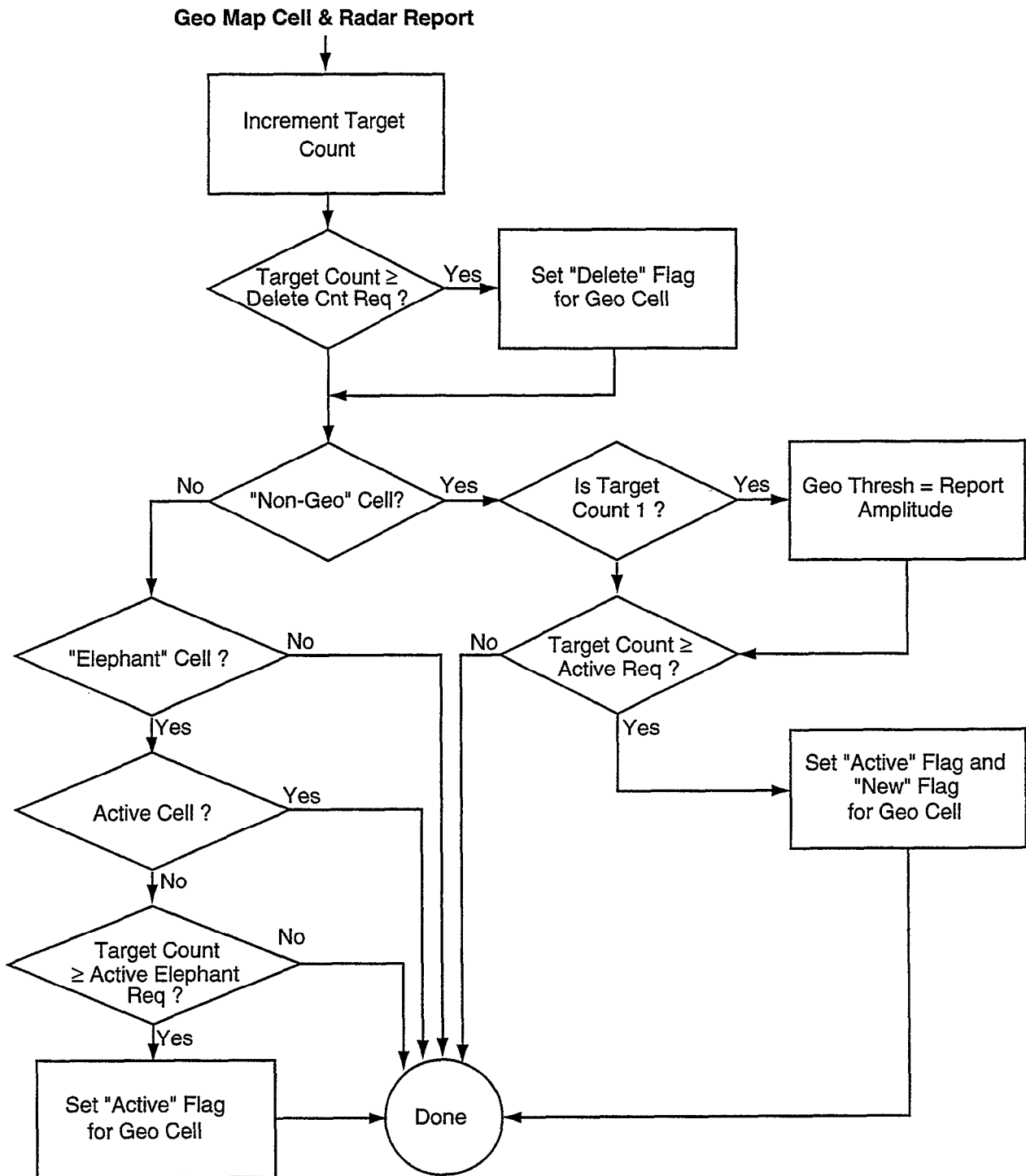

Figure C-21. Incrementing the geocensor map cell counts.

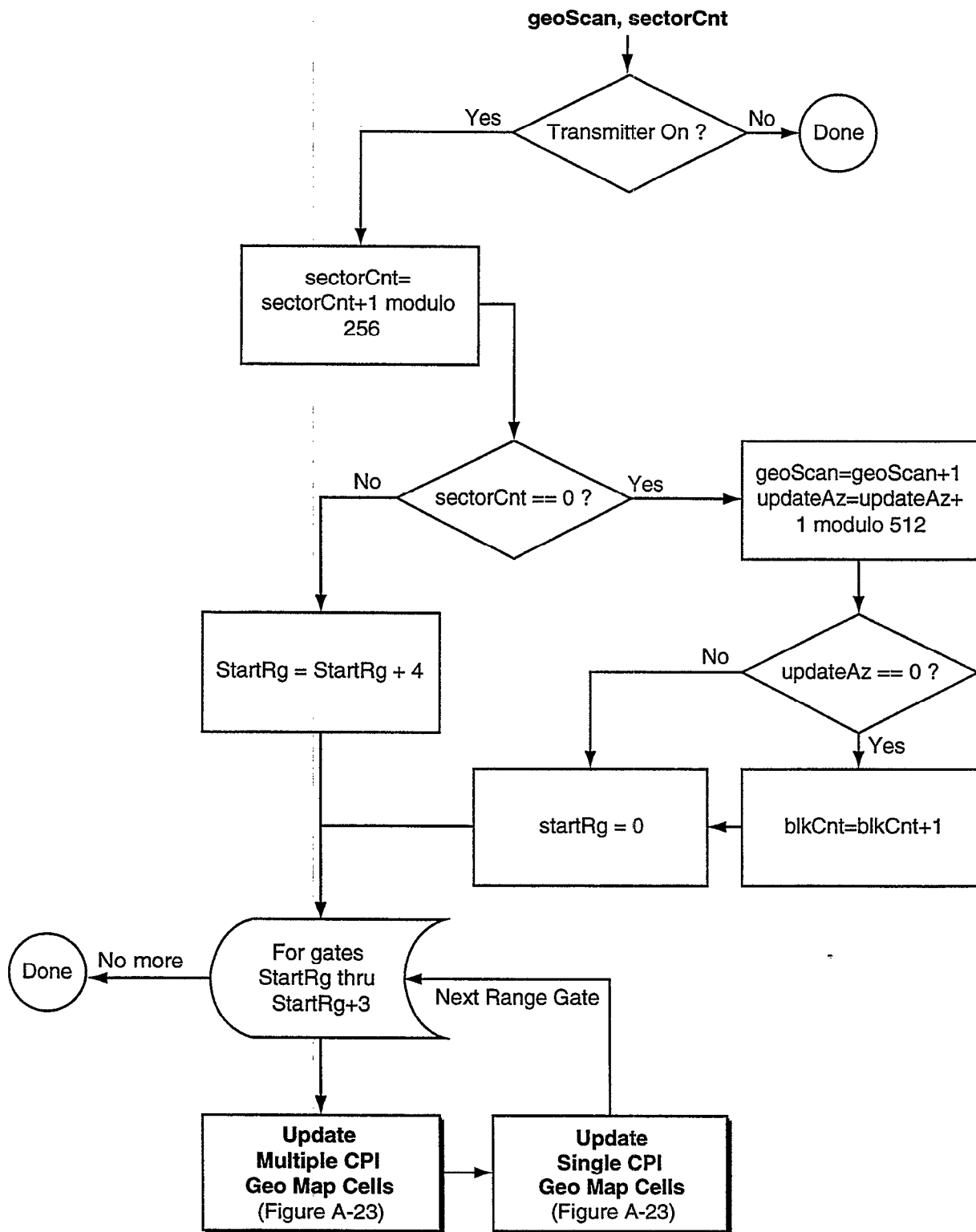

Figure C-22. Geocensor map update at the end of a 512-scan block.

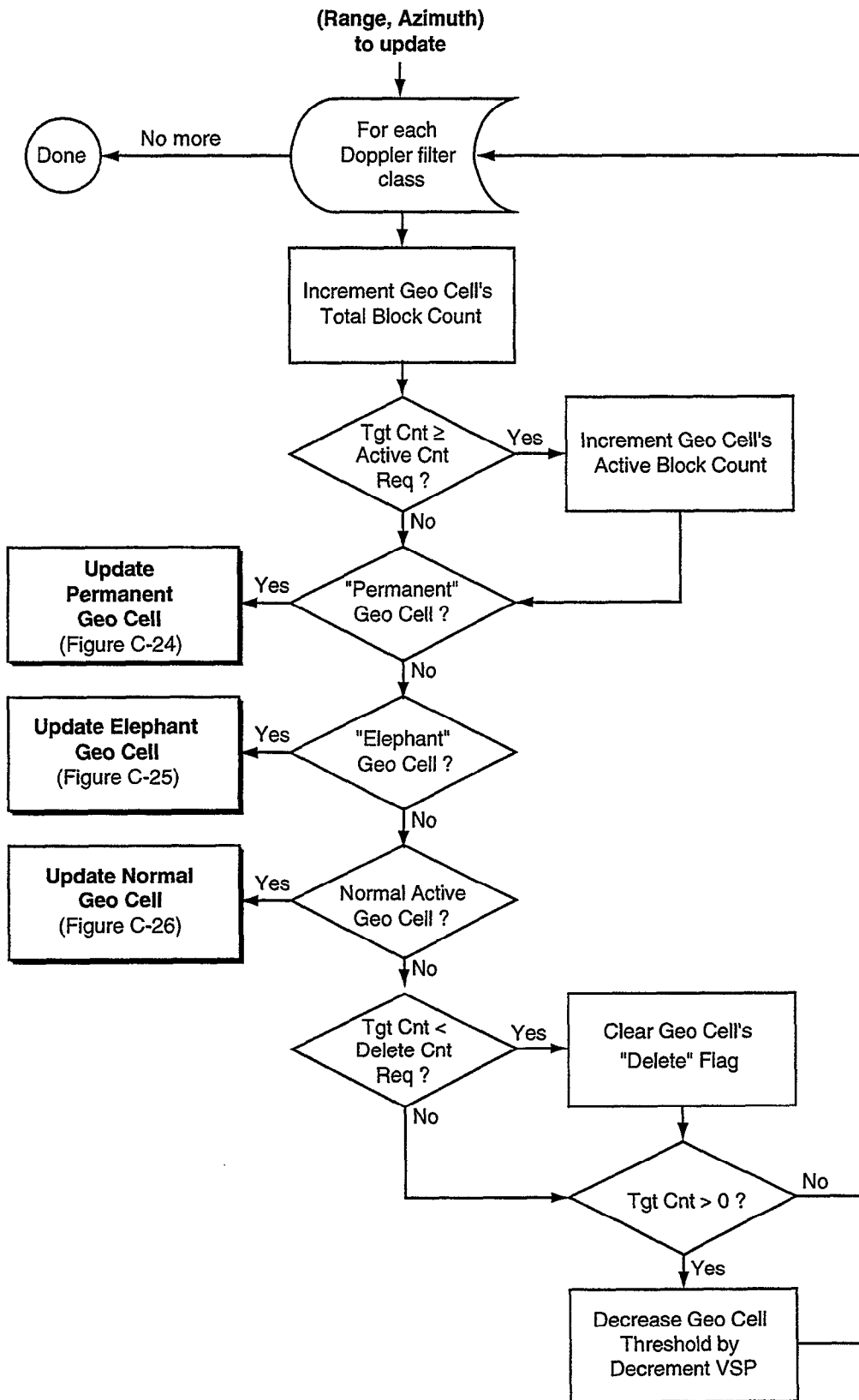
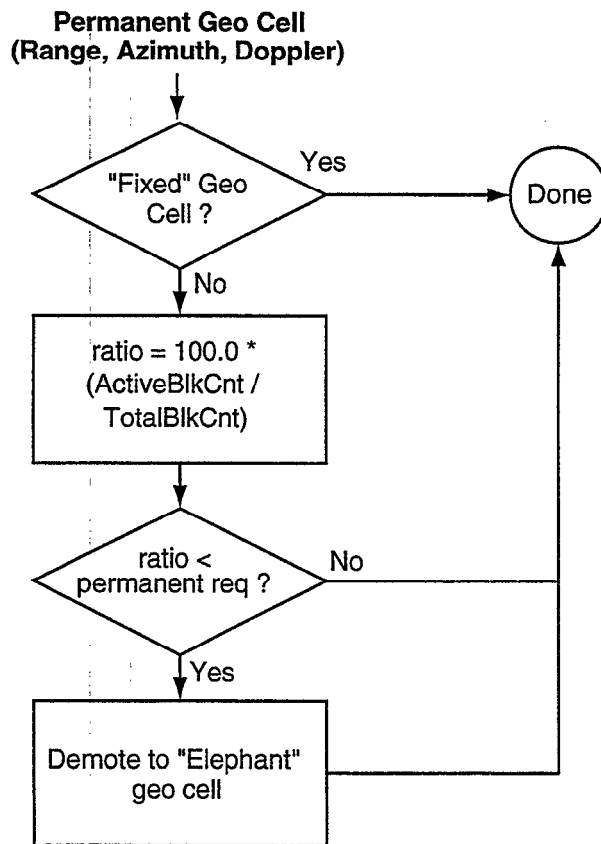

Figure C-23. Geocensor map cells update for given range and azimuth.



*Figure C-24. Permanent geocensor cell update.*

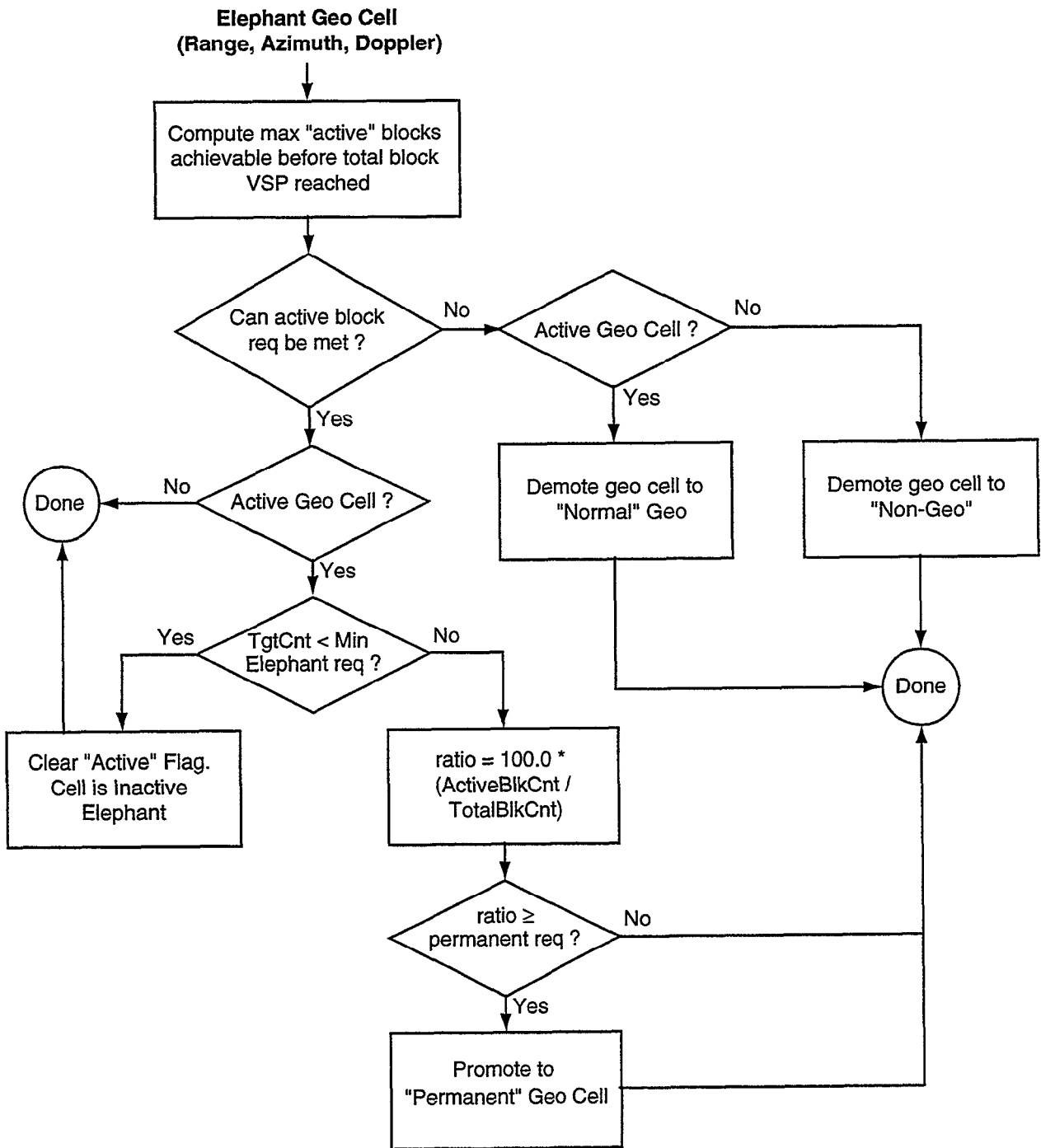
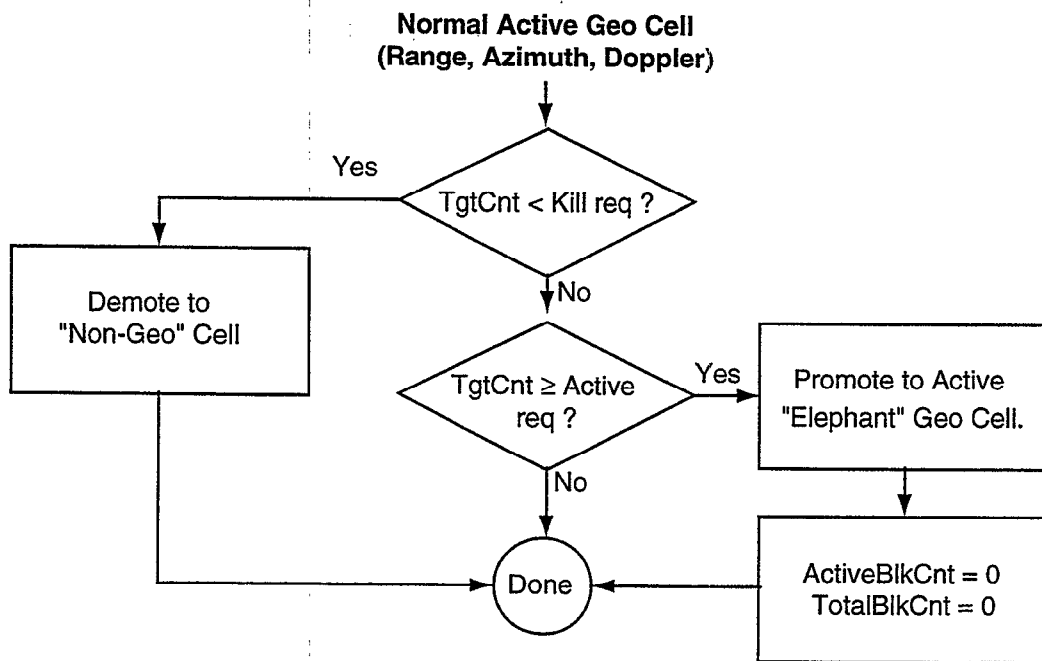
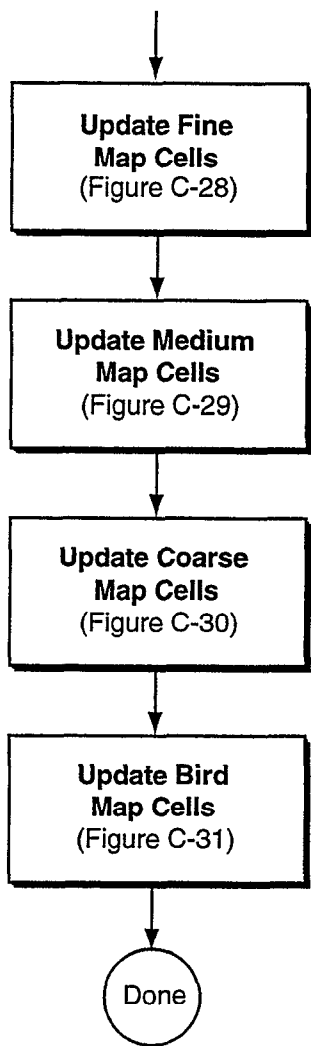

Figure C-25. Elephant geocensor cell update.



*Figure C-26. Normal geocensor cell update.*



*Figure C-27. Adaptive map update.*



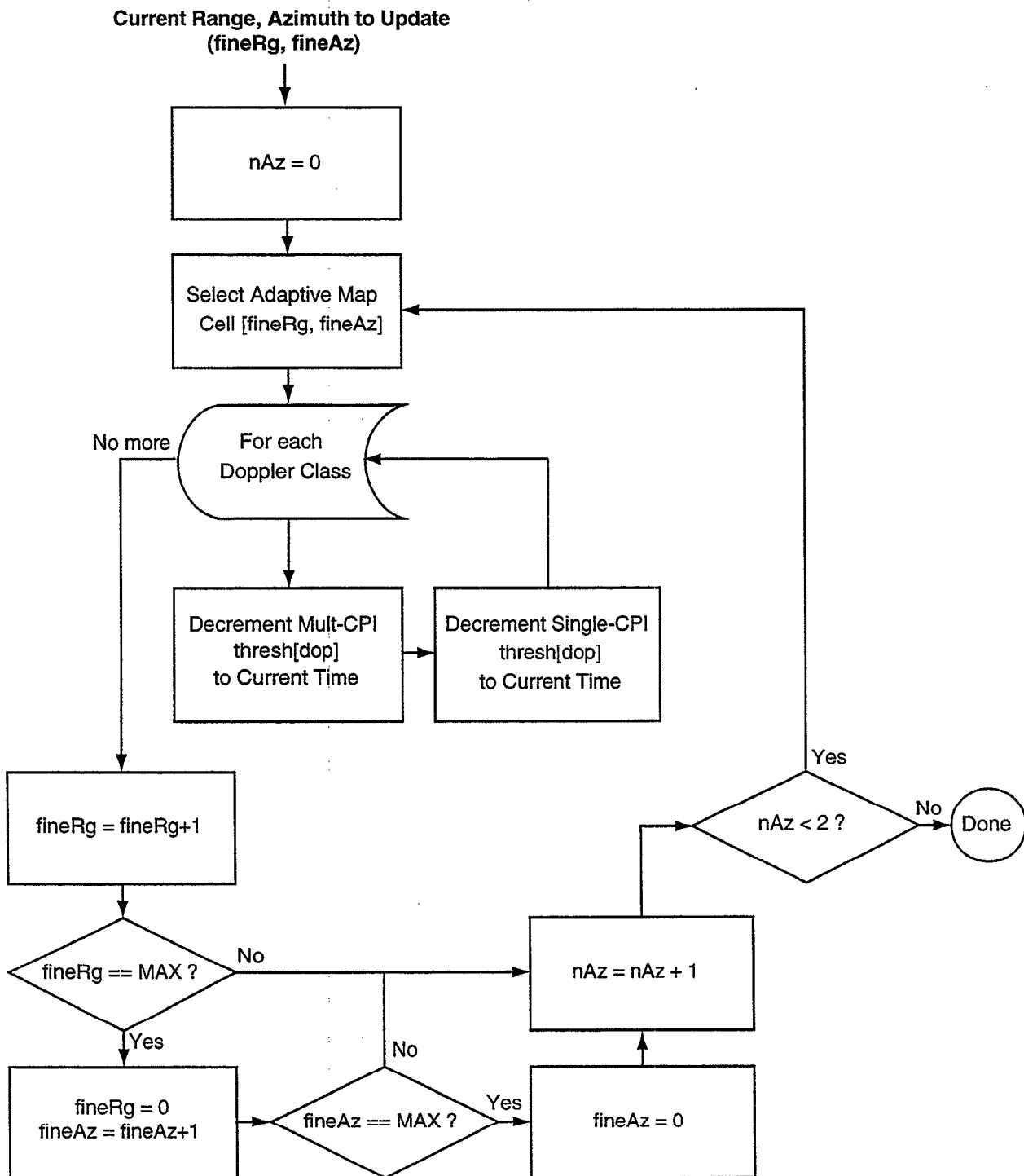
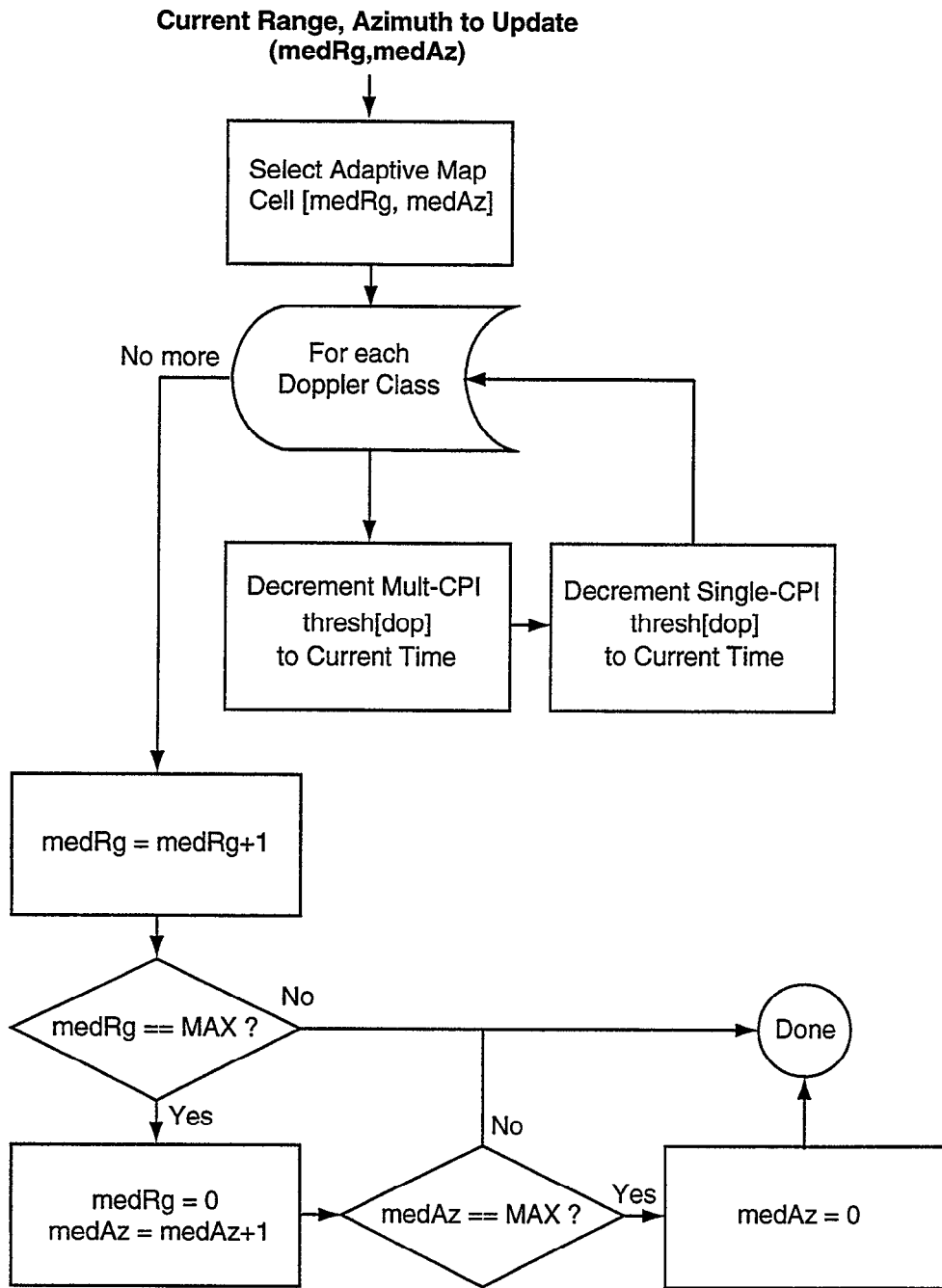

Figure C-28. Fine adaptive map update.



*Figure C-29. Medium adaptive map update.*

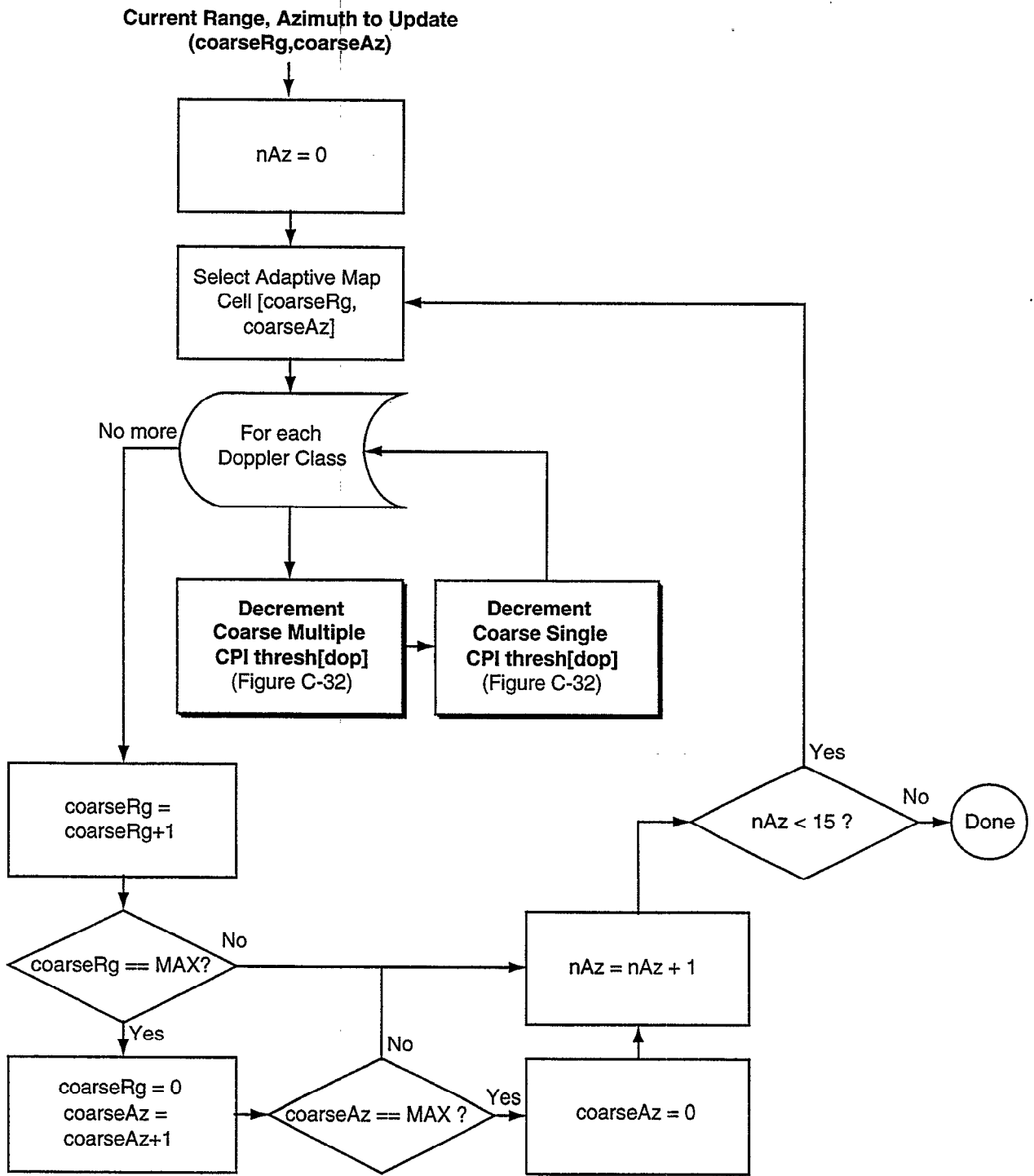

Figure C-30. Coarse adaptive map update.

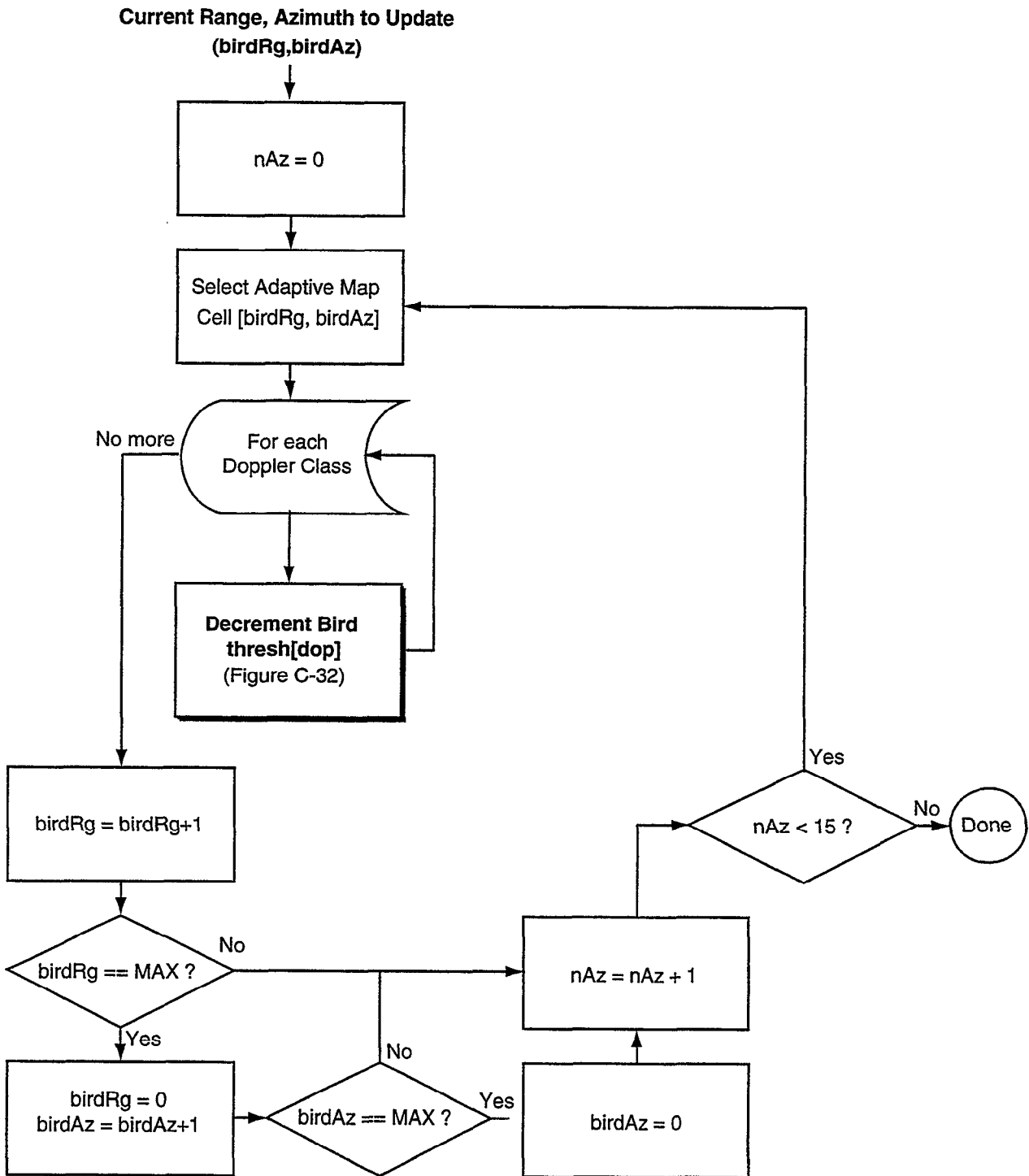
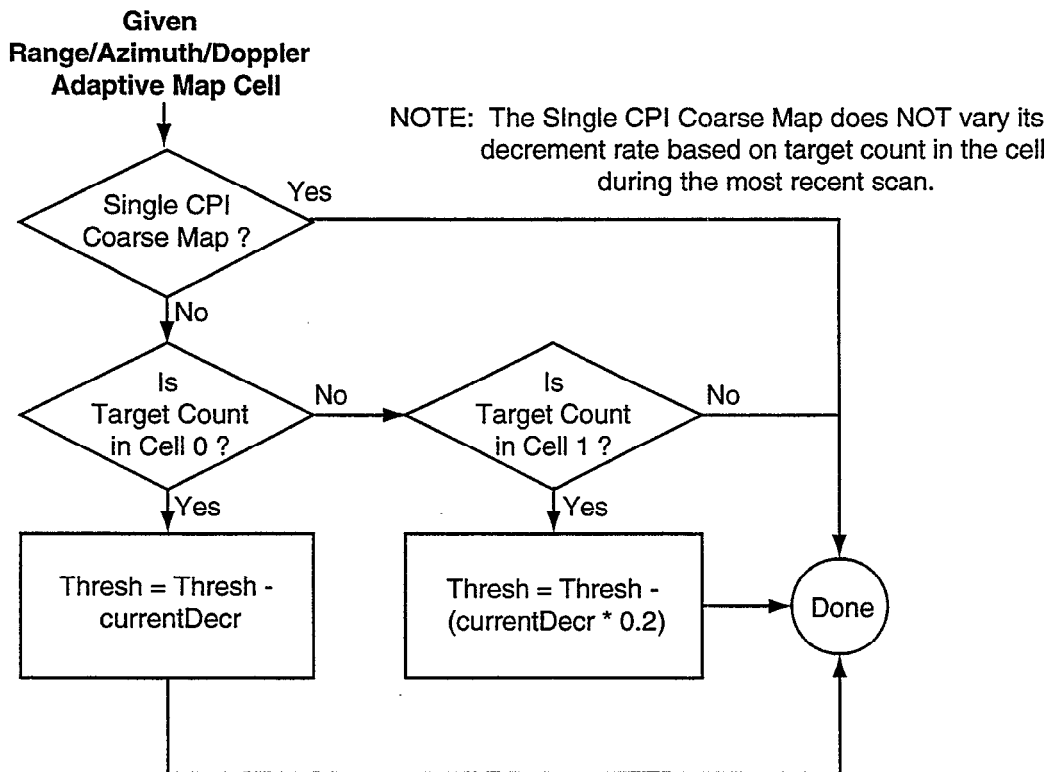

Figure C-31. Bird adaptive map update.



NOTE: The Multiple CPI Coarse Map, Single CPI Coarse Map, and Bird Map each set a separate currentDecr value based on averaged target density over the entire radar coverage window and VSPs.

Figure C-32. Threshold decrement for coarse and bird adaptive map cells.

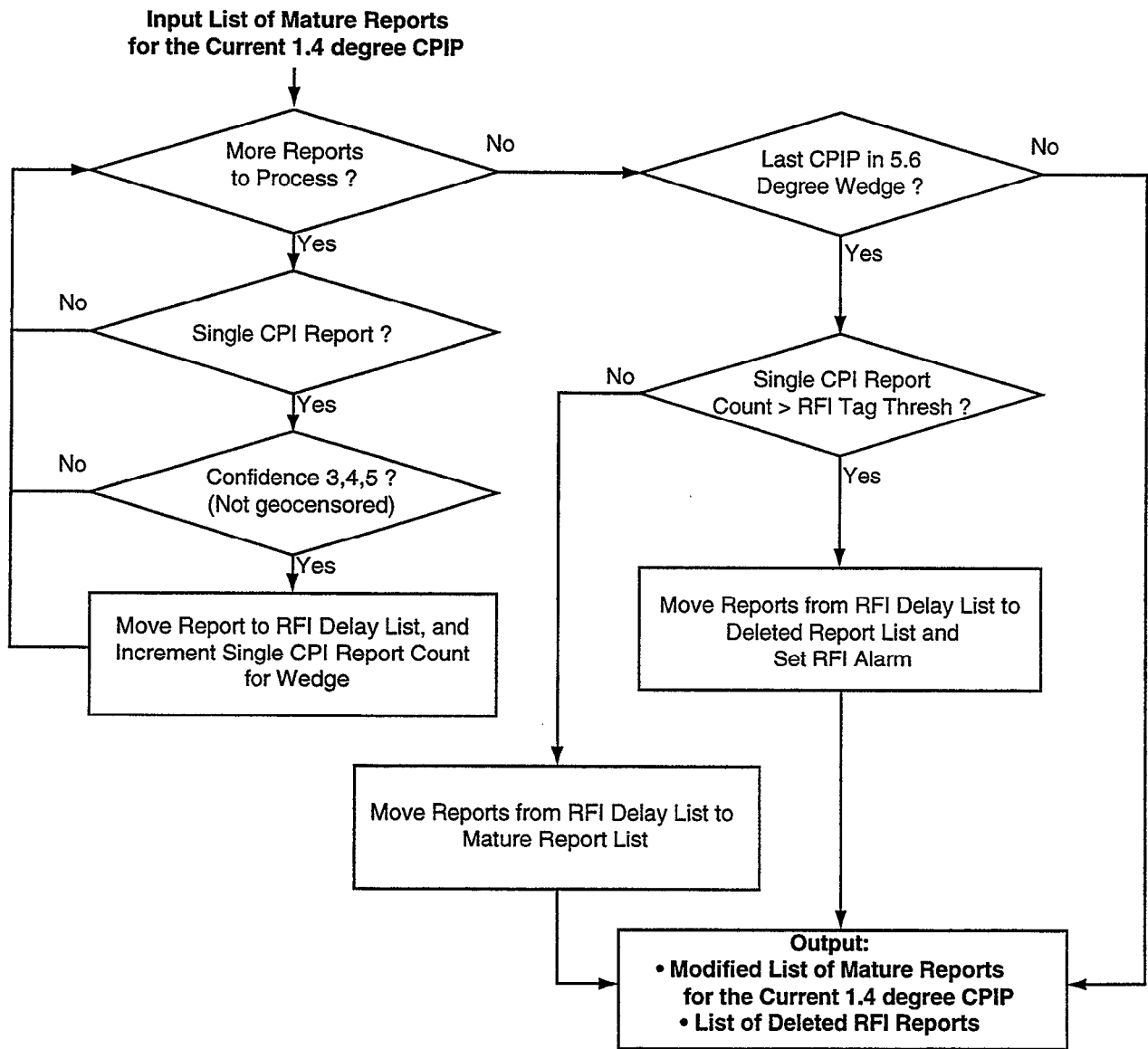

Figure C-33. Supplemental RFI processing.

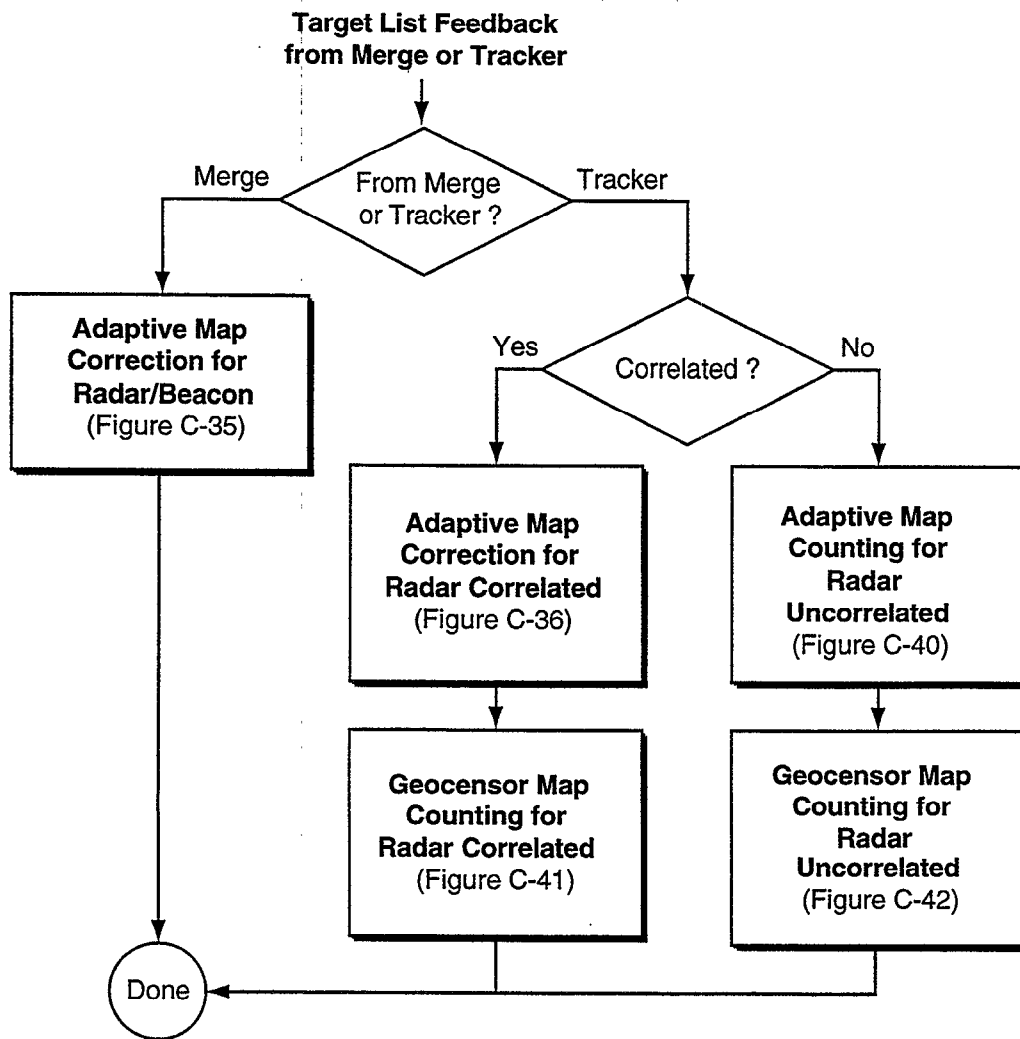

Figure C-34. Geocensor and adaptive map feedback processing.

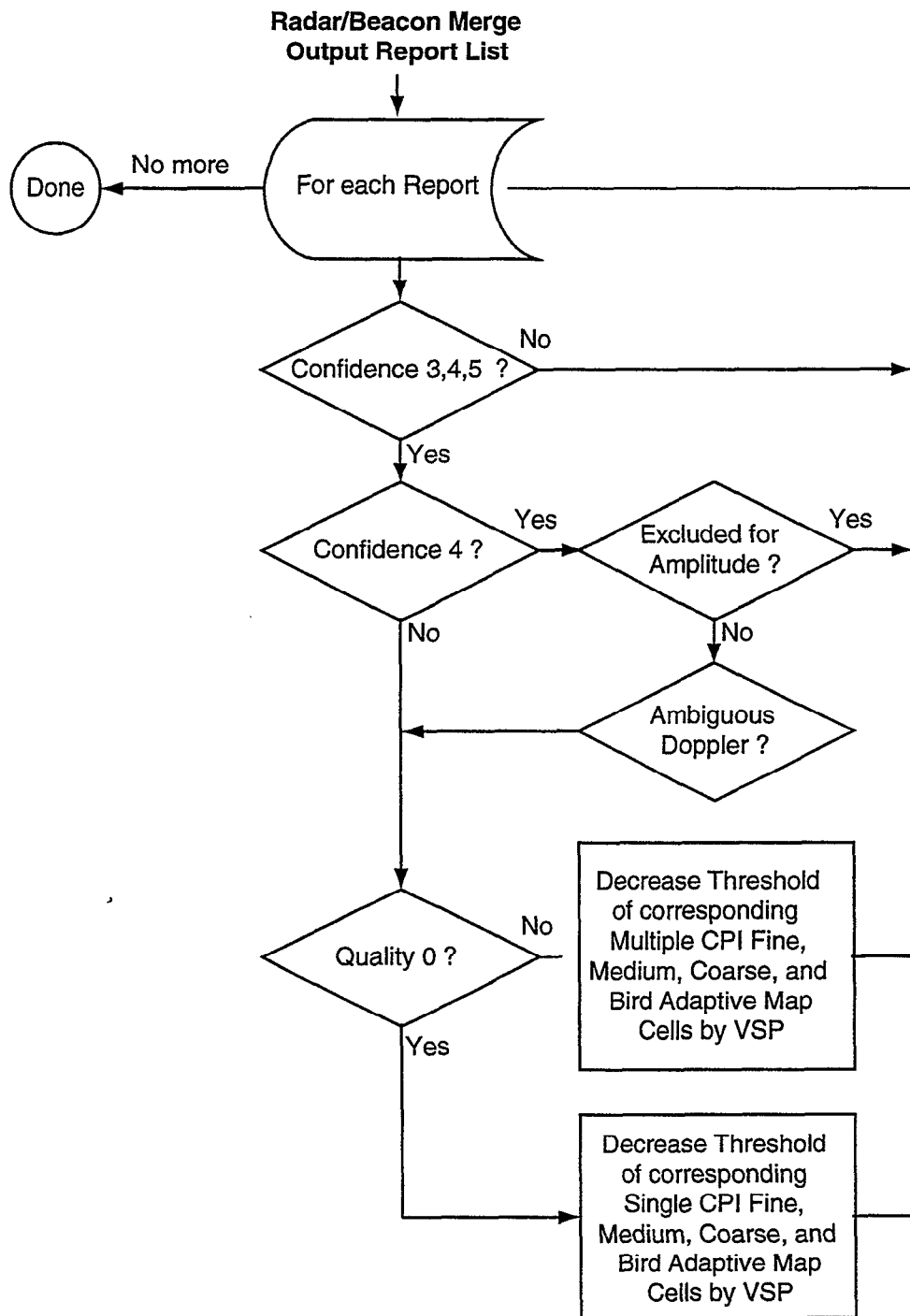

Figure C-35. Adaptive map correction for radar-beacon reports output by the Merge.



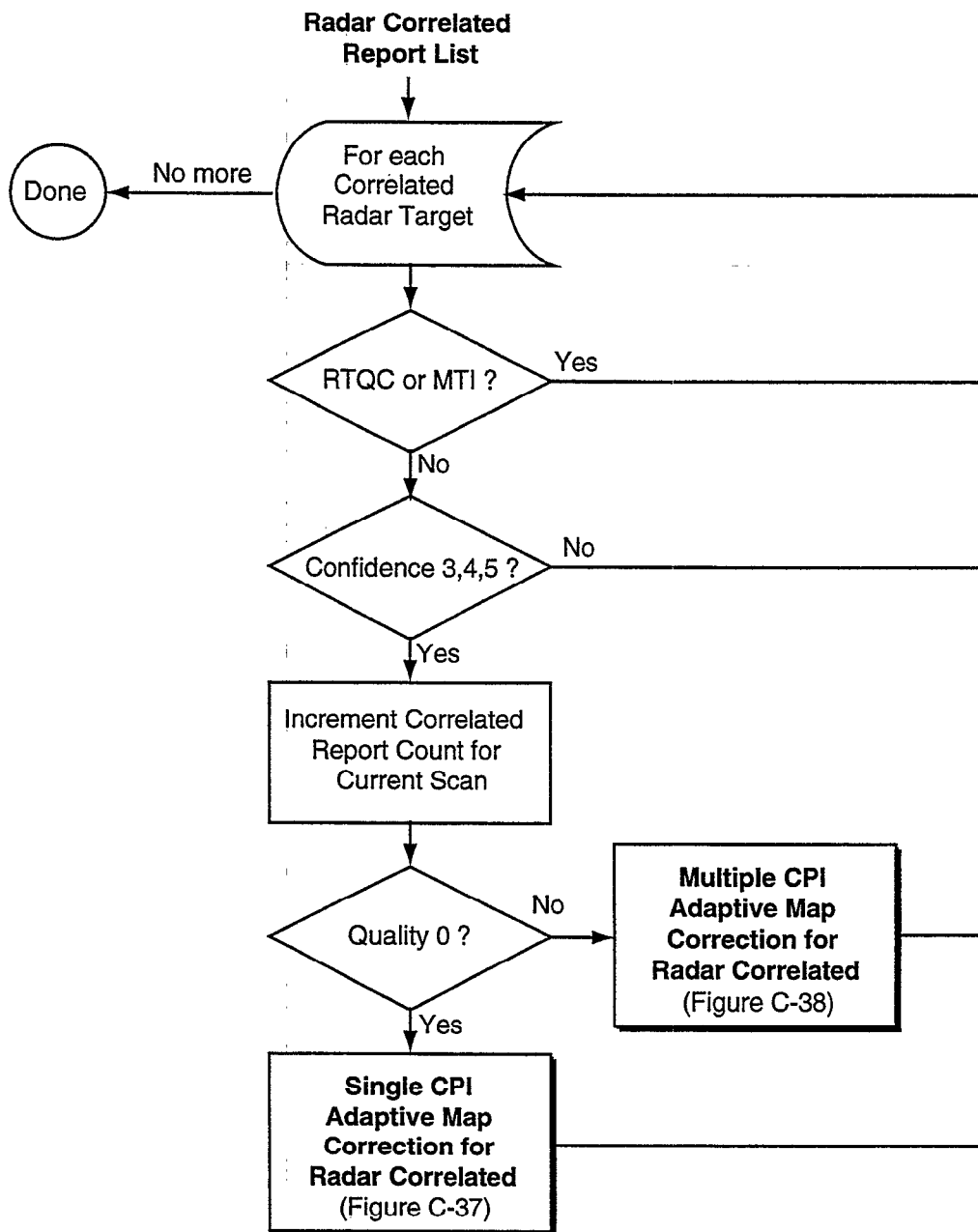

Figure C-36. Adaptive map correction for correlated radar reports output by the Tracker.

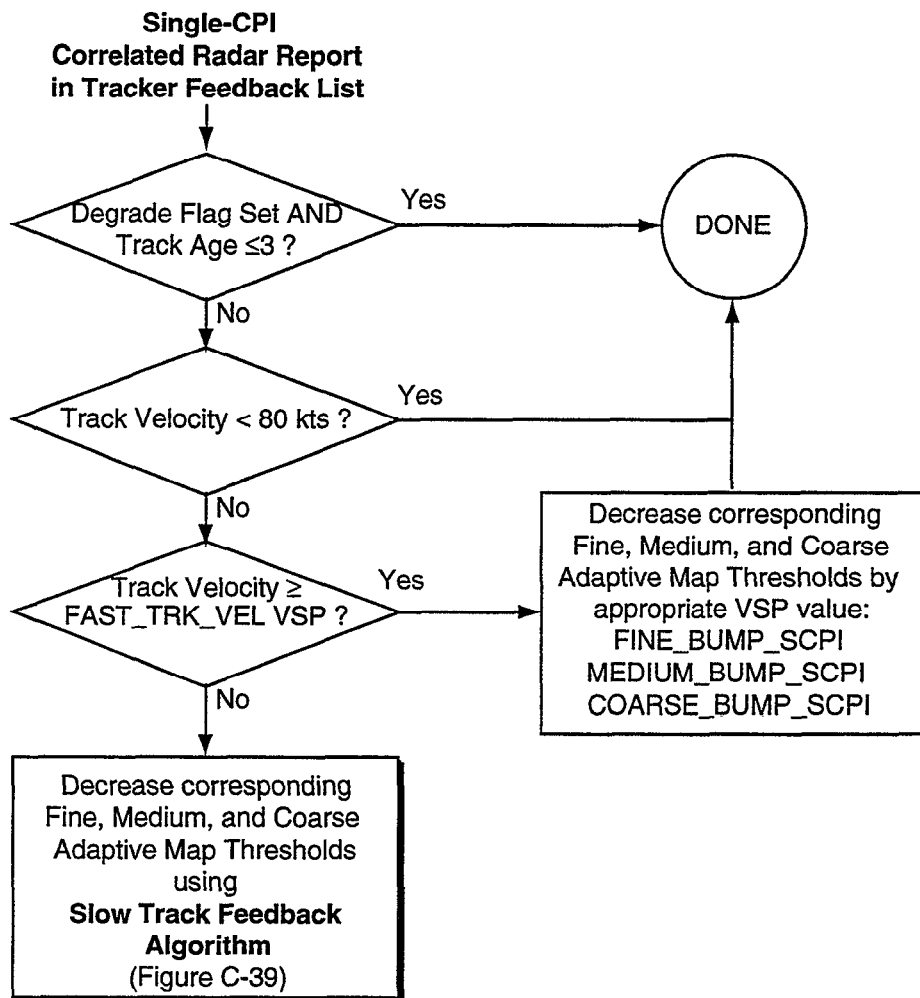
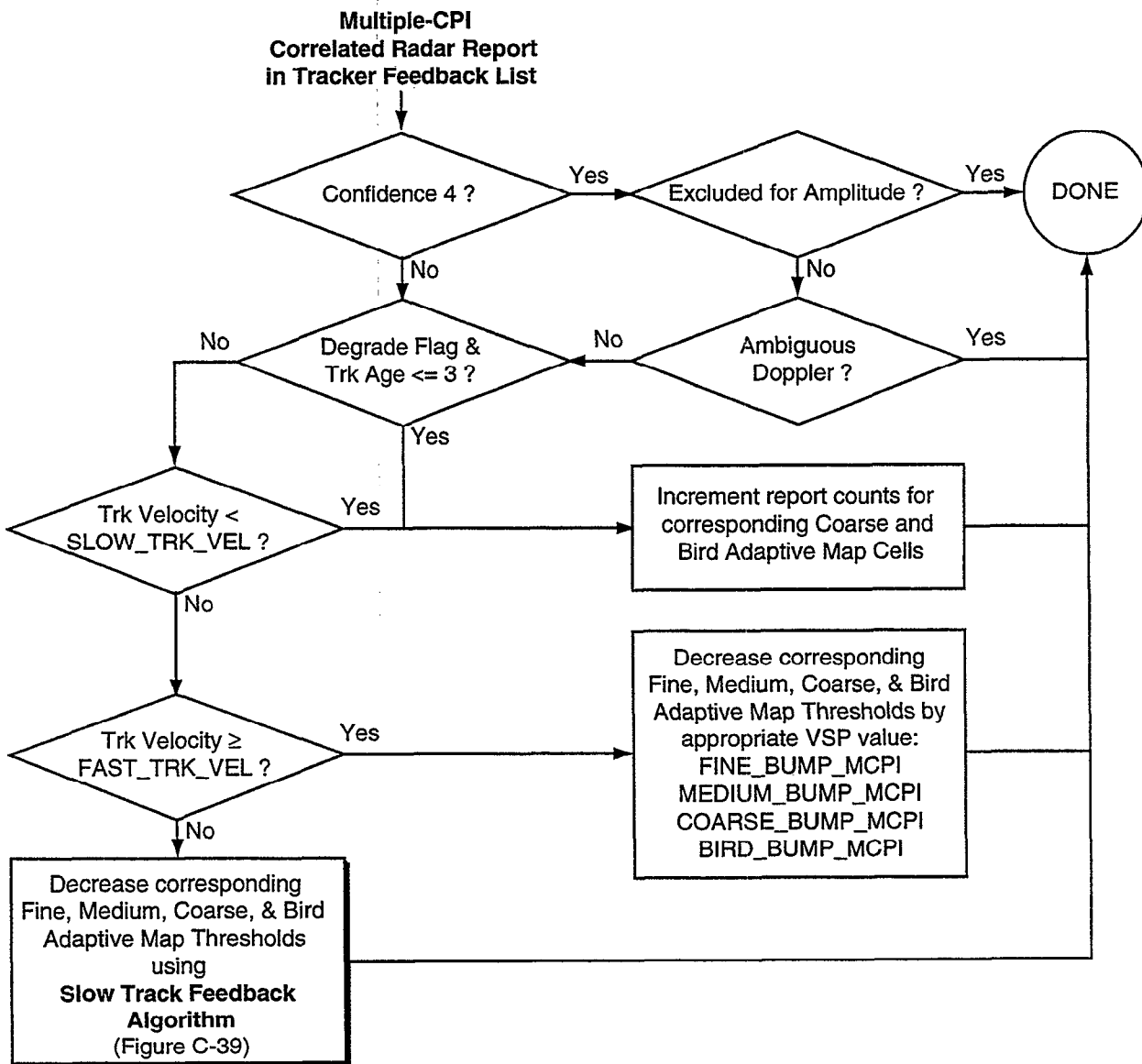

Figure C-37. Single CPI adaptive map correction for correlated radar reports.



**NOTE:** Correlated radar report feedback is limited to once per scan per Adaptive Map Cell. This is not pictured in the flow chart. The test is performed separately for the appropriate (Range, Azimuth, Doppler) cell in the Fine, Medium, Coarse, and Bird Adaptive Maps.

*Figure C-38. Multiple CPI adaptive map correction for correlated radar reports.*

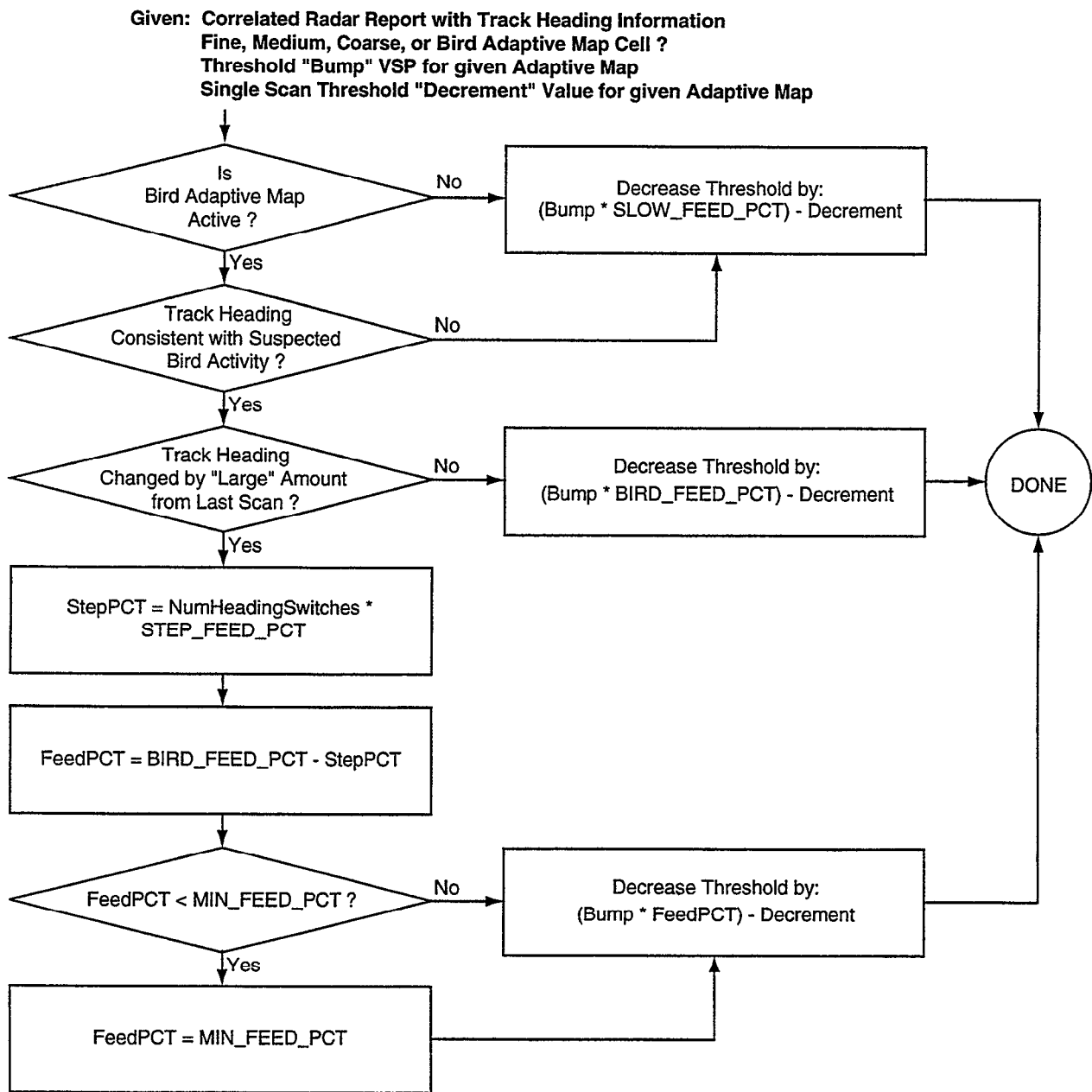

Figure C-39. Adaptive map correction for slow-moving tracks.

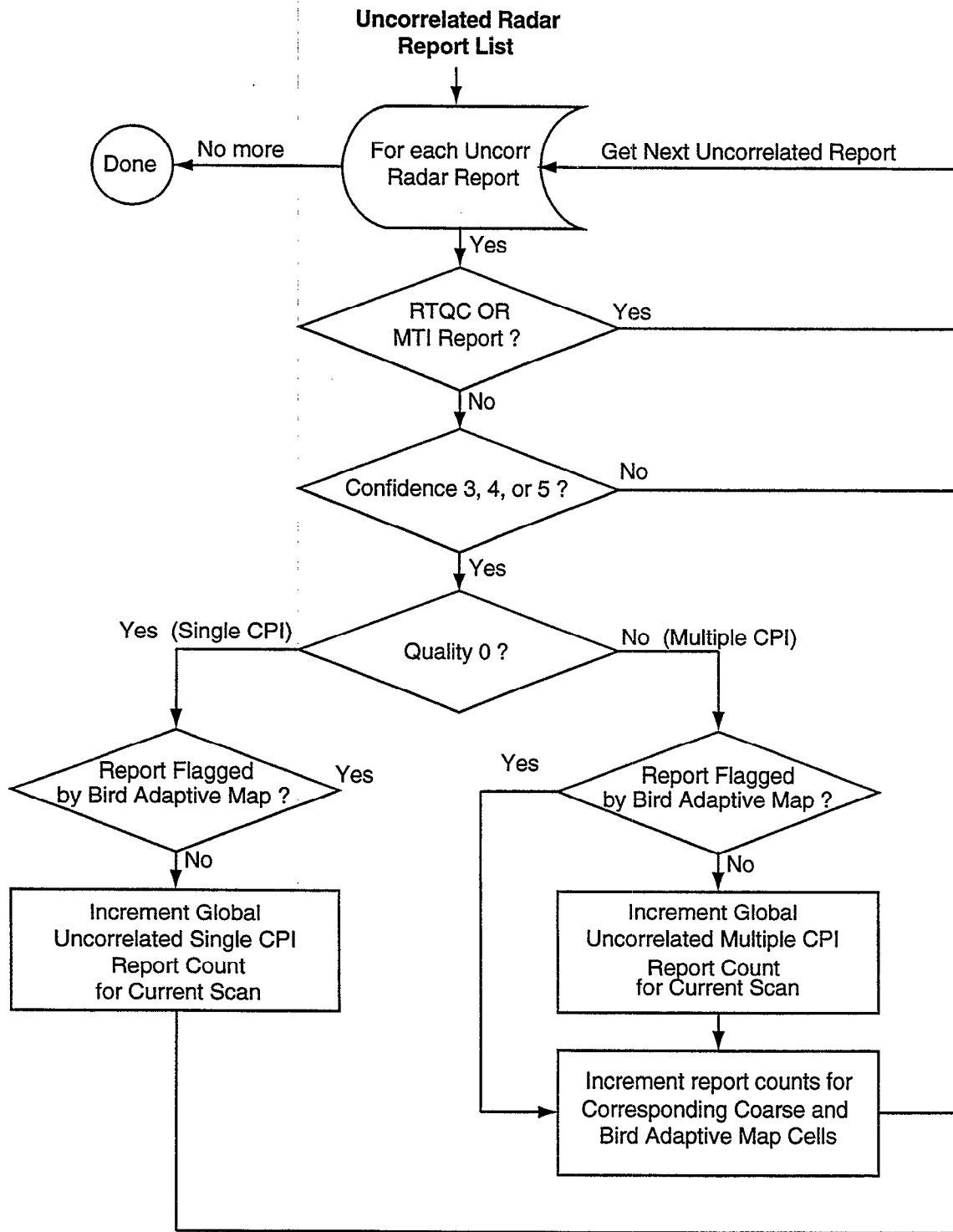

Figure C-40. Adaptive map report counting for uncorrelated radar reports.

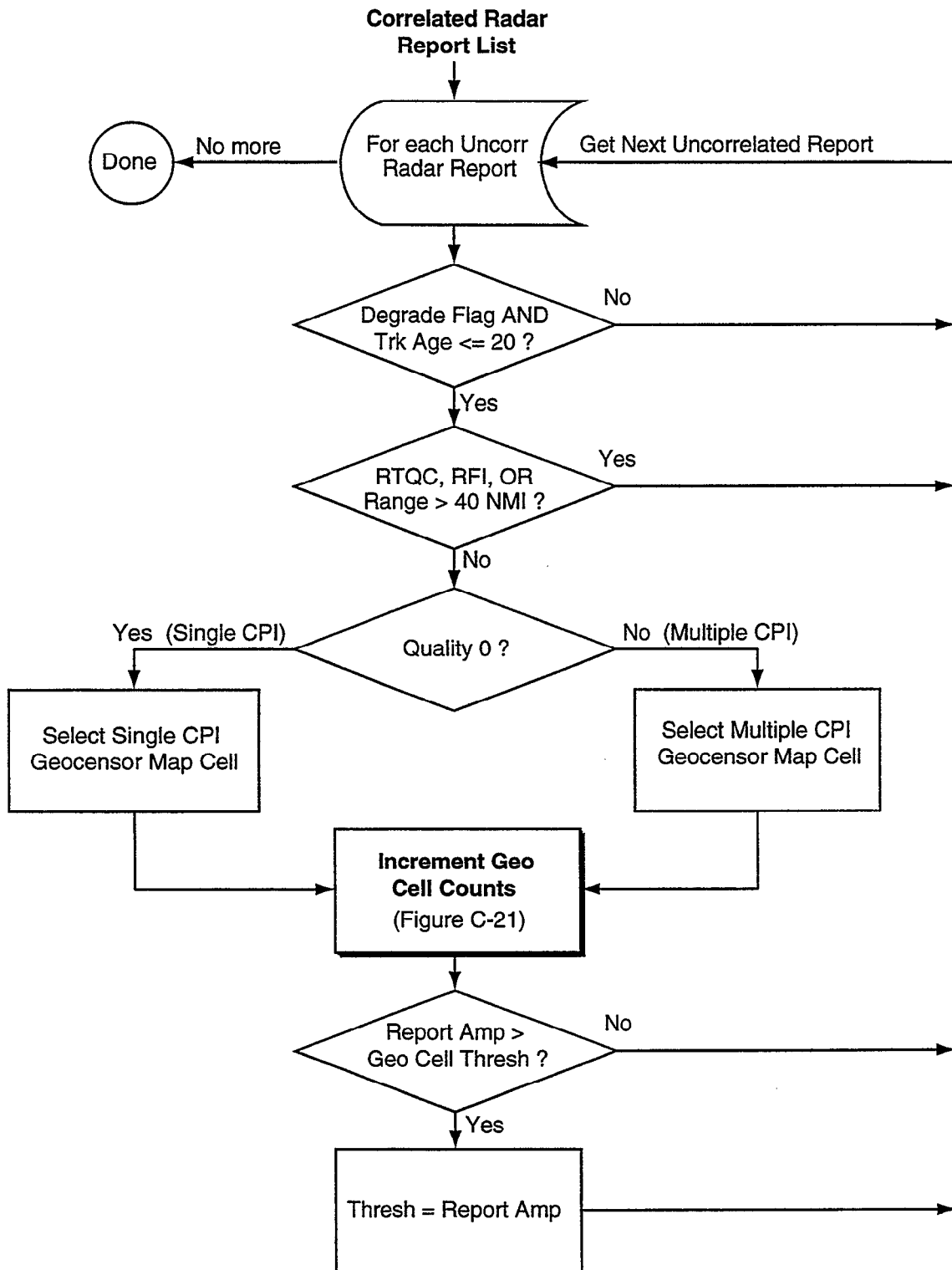

Figure C-41. Geocensor map report counting for correlated radar reports.

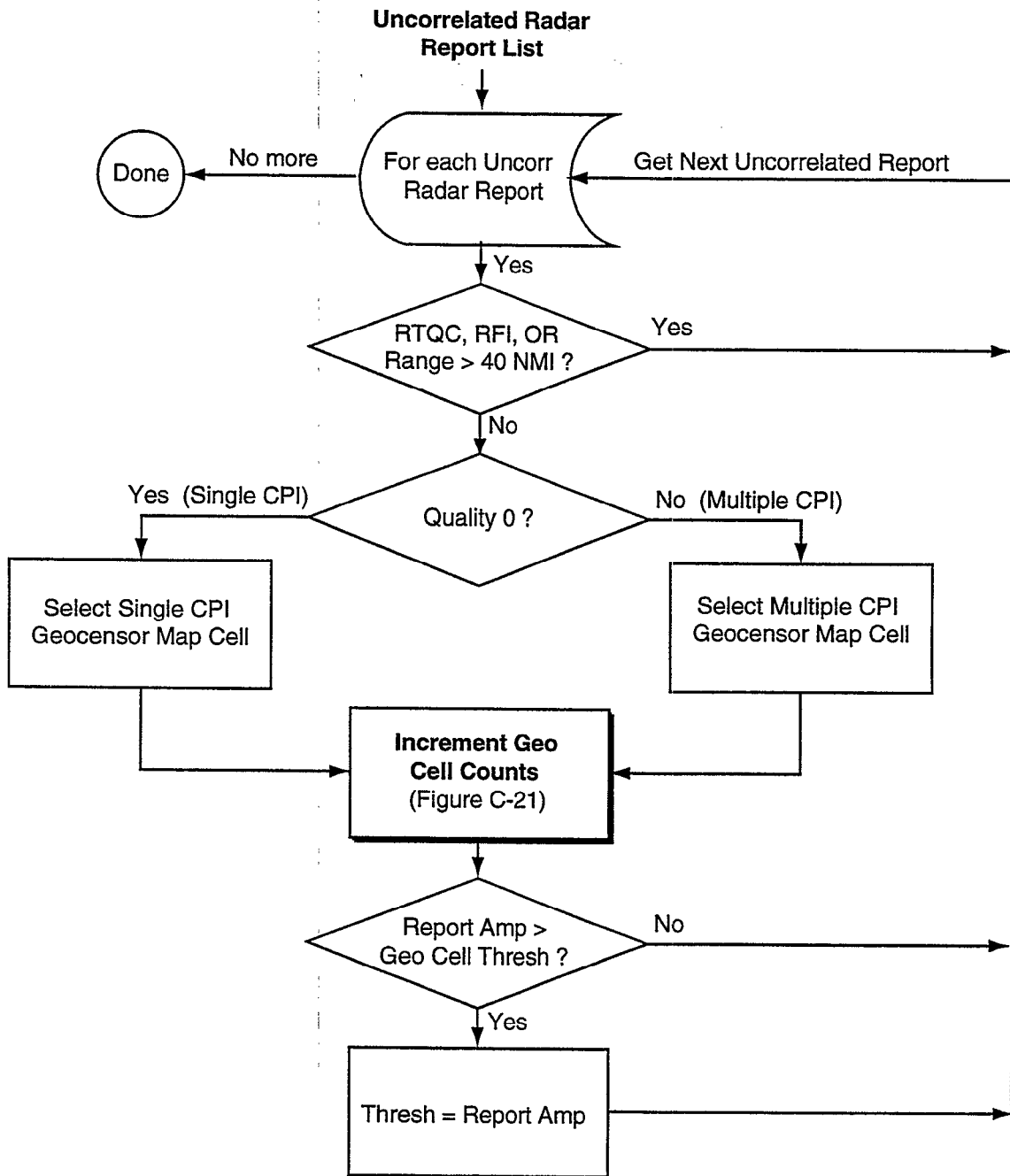
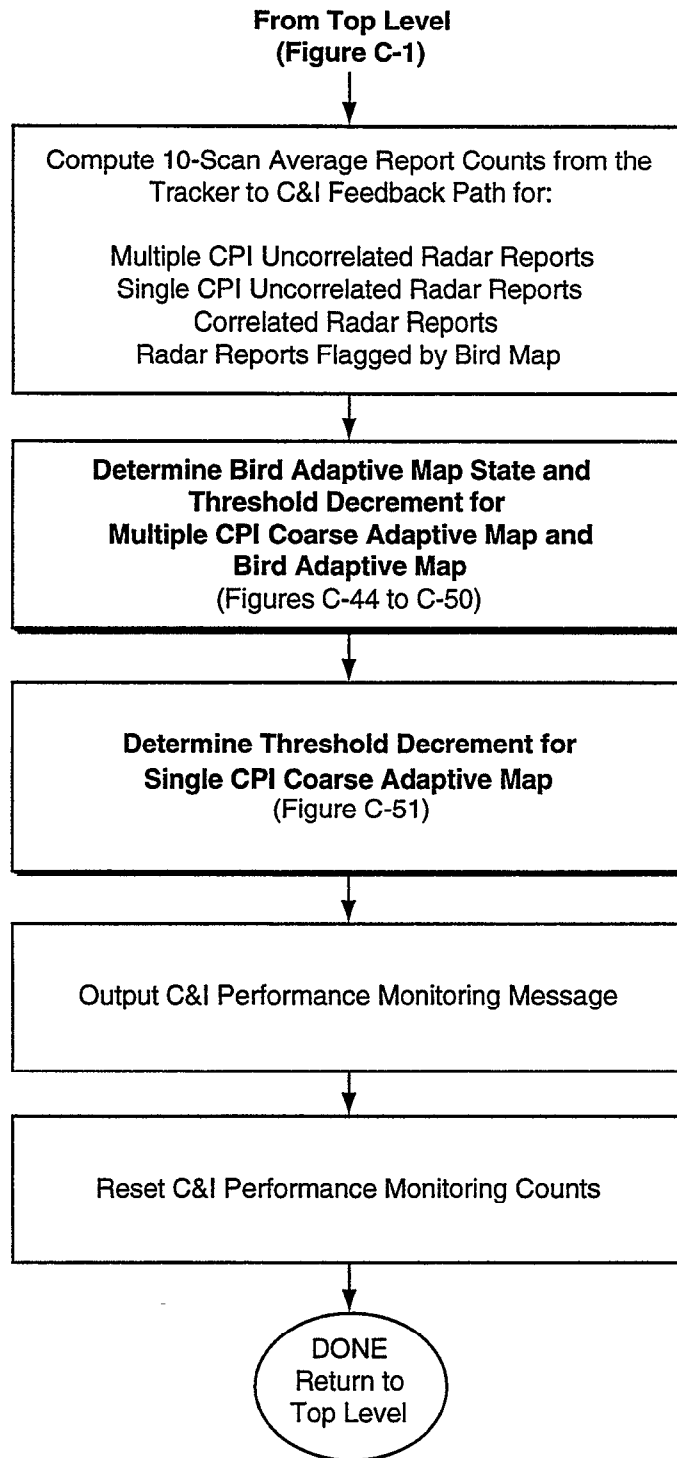

Figure C-42. Geocensor map report counting for uncorrelated radar reports.



*Figure C-43. North mark processing.*



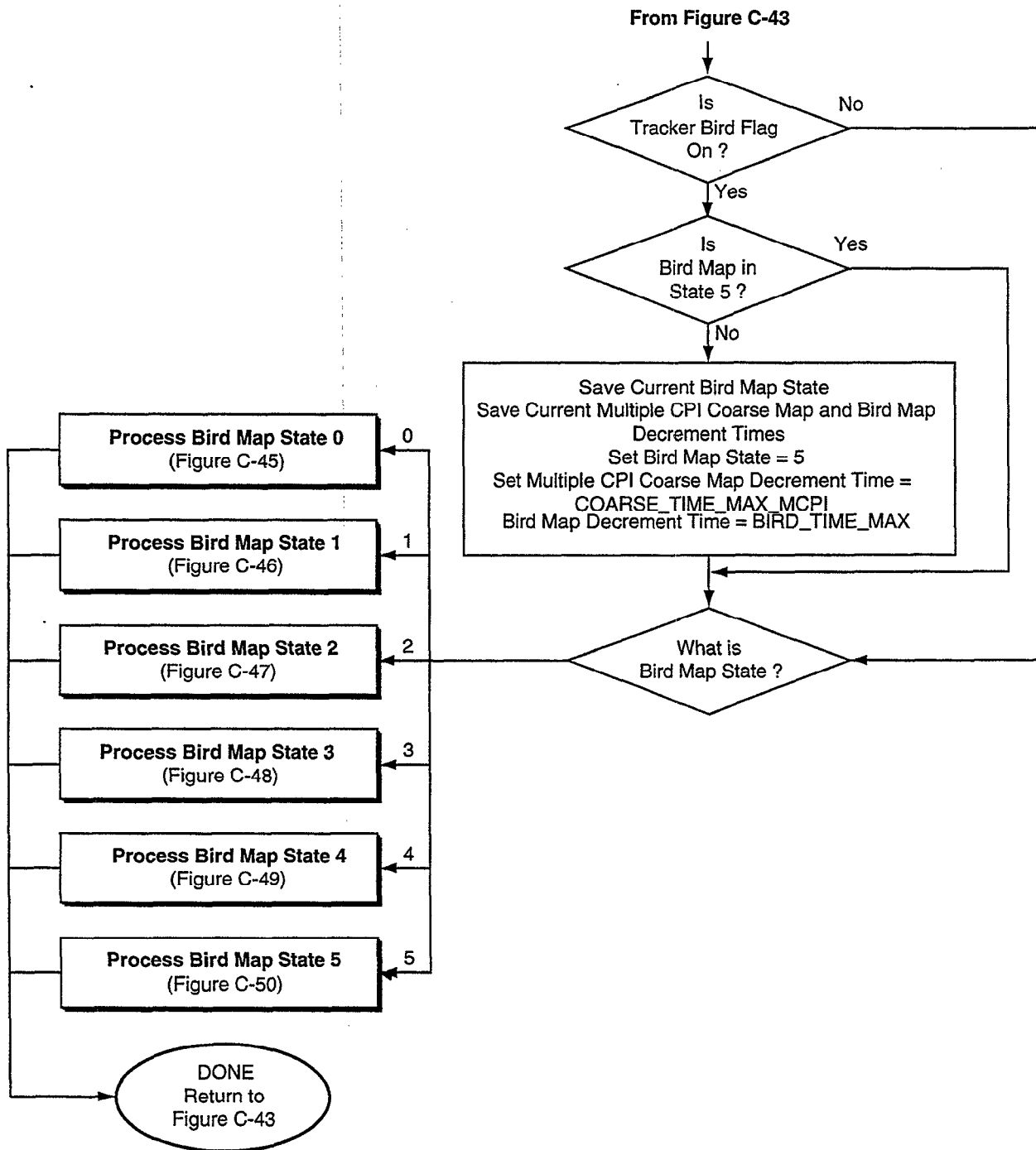

Figure C-44. Bird adaptive map state determination.

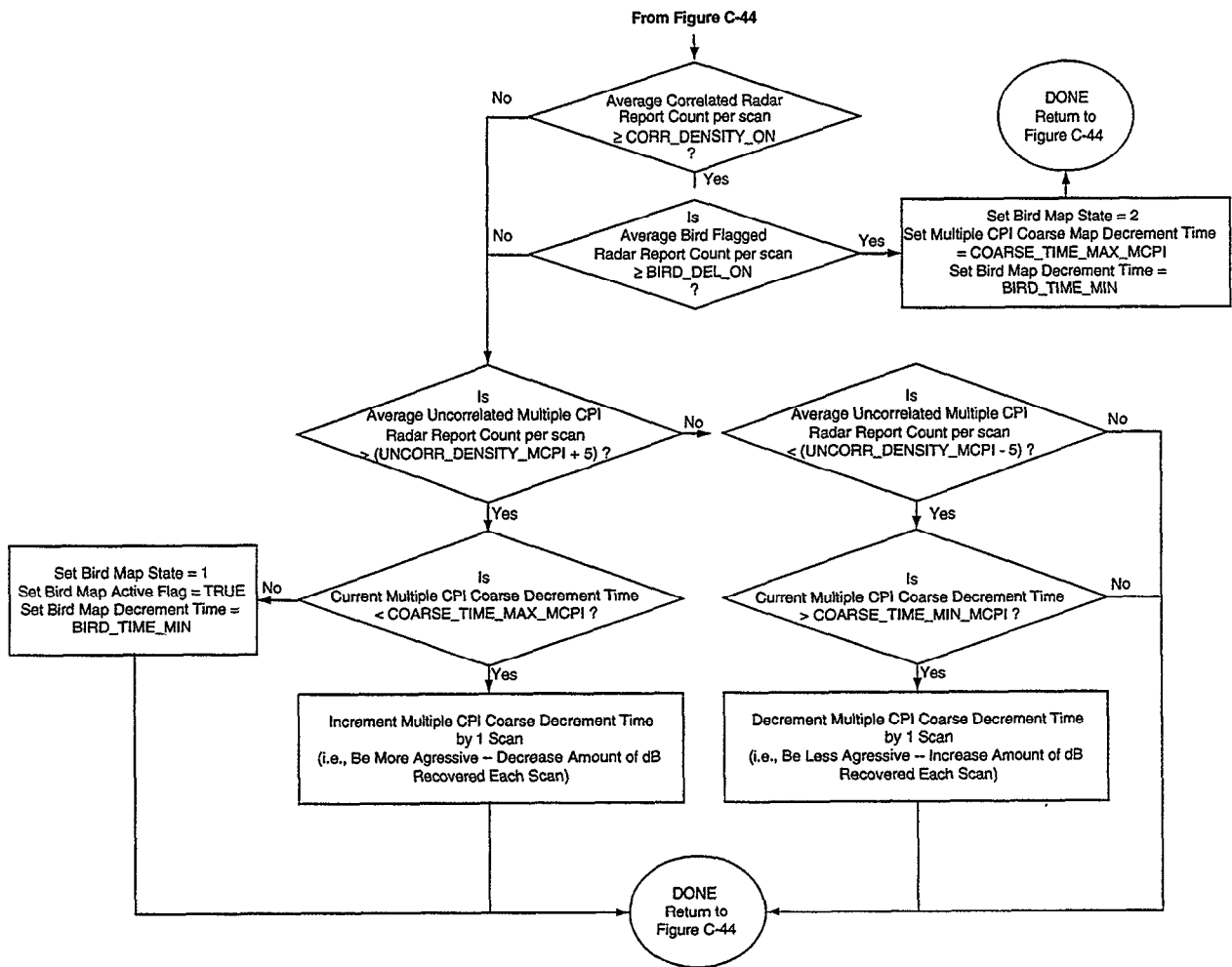

Figure C-45. Bird adaptive map state 0 processing.

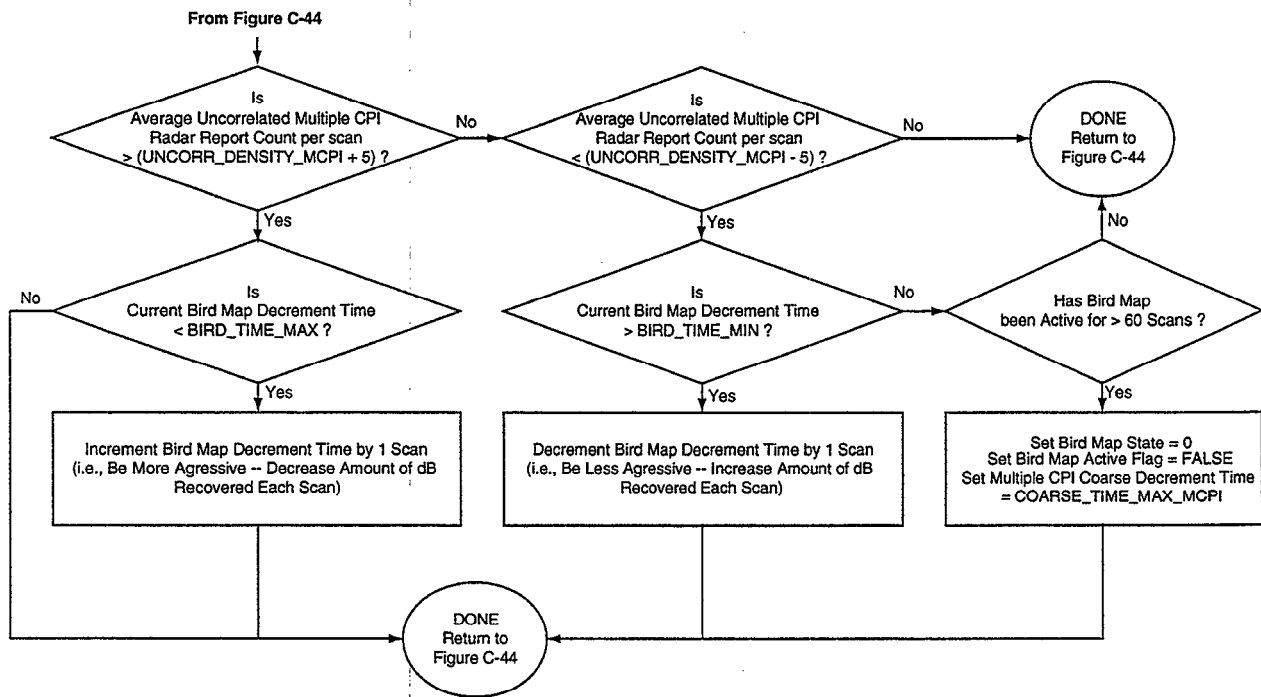

Figure C-46. Bird adaptive map state 1 processing.

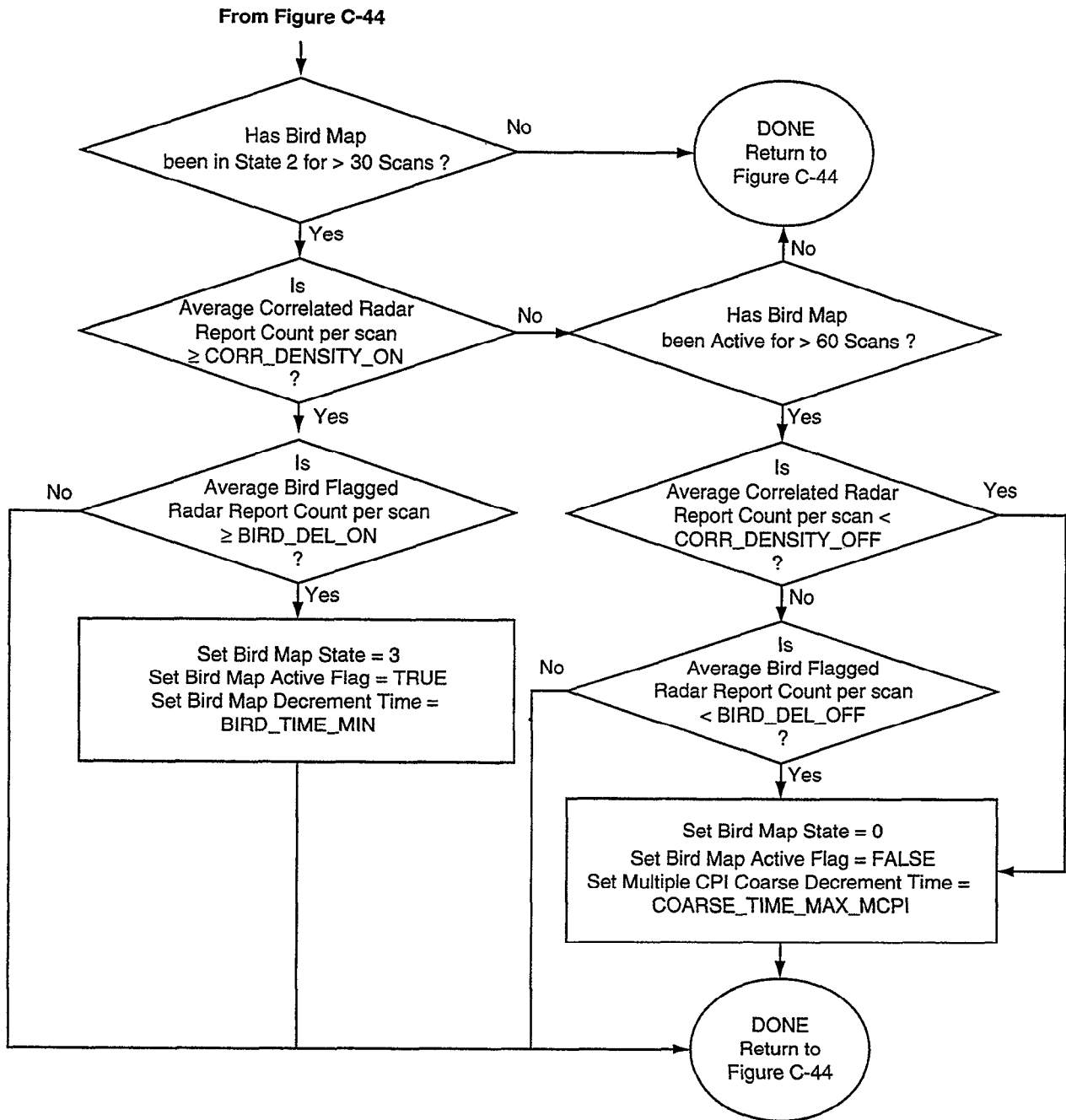

Figure C-47. Bird adaptive map state 2 processing.

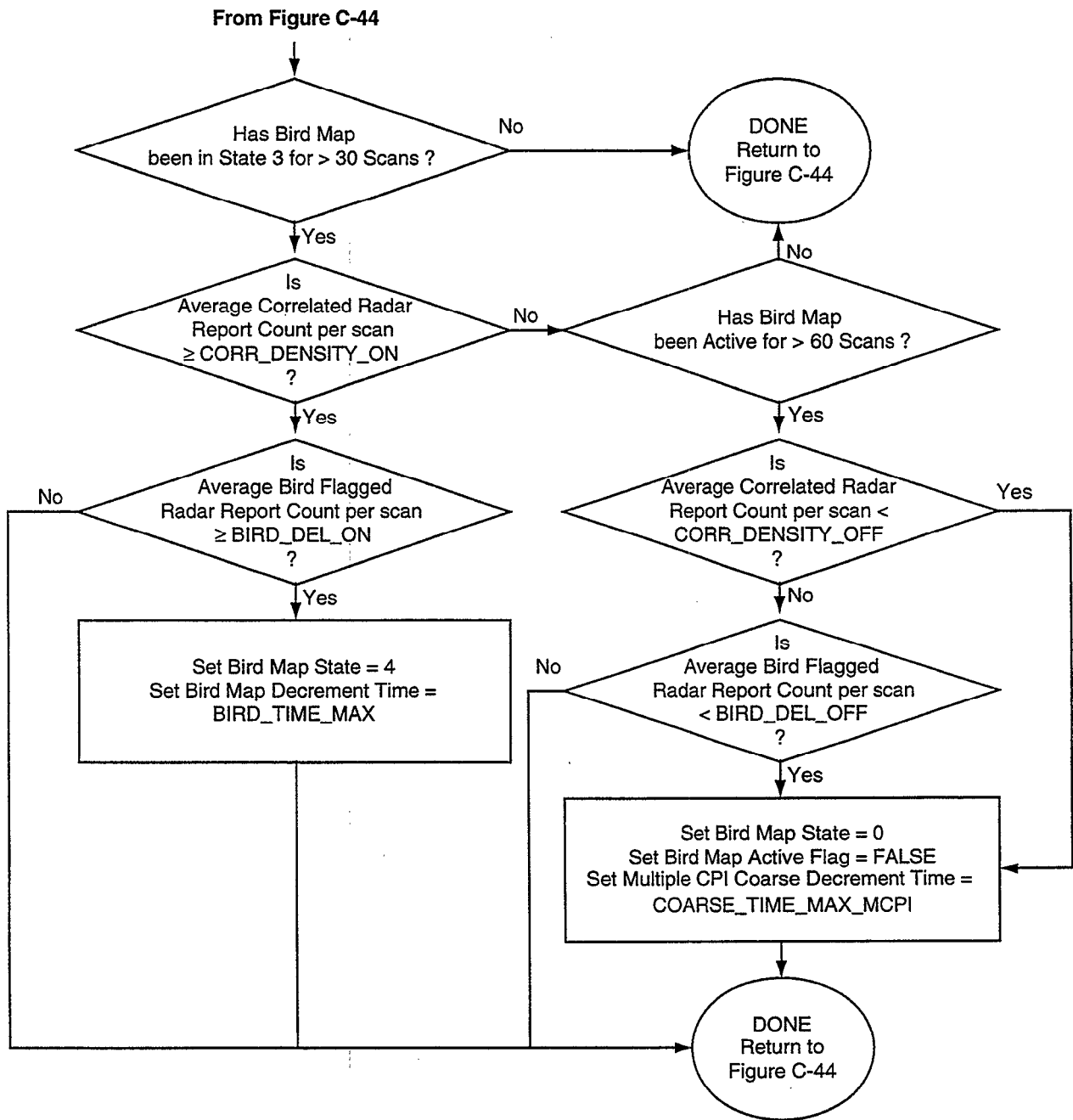

Figure C-48. Bird adaptive map state 3 processing.

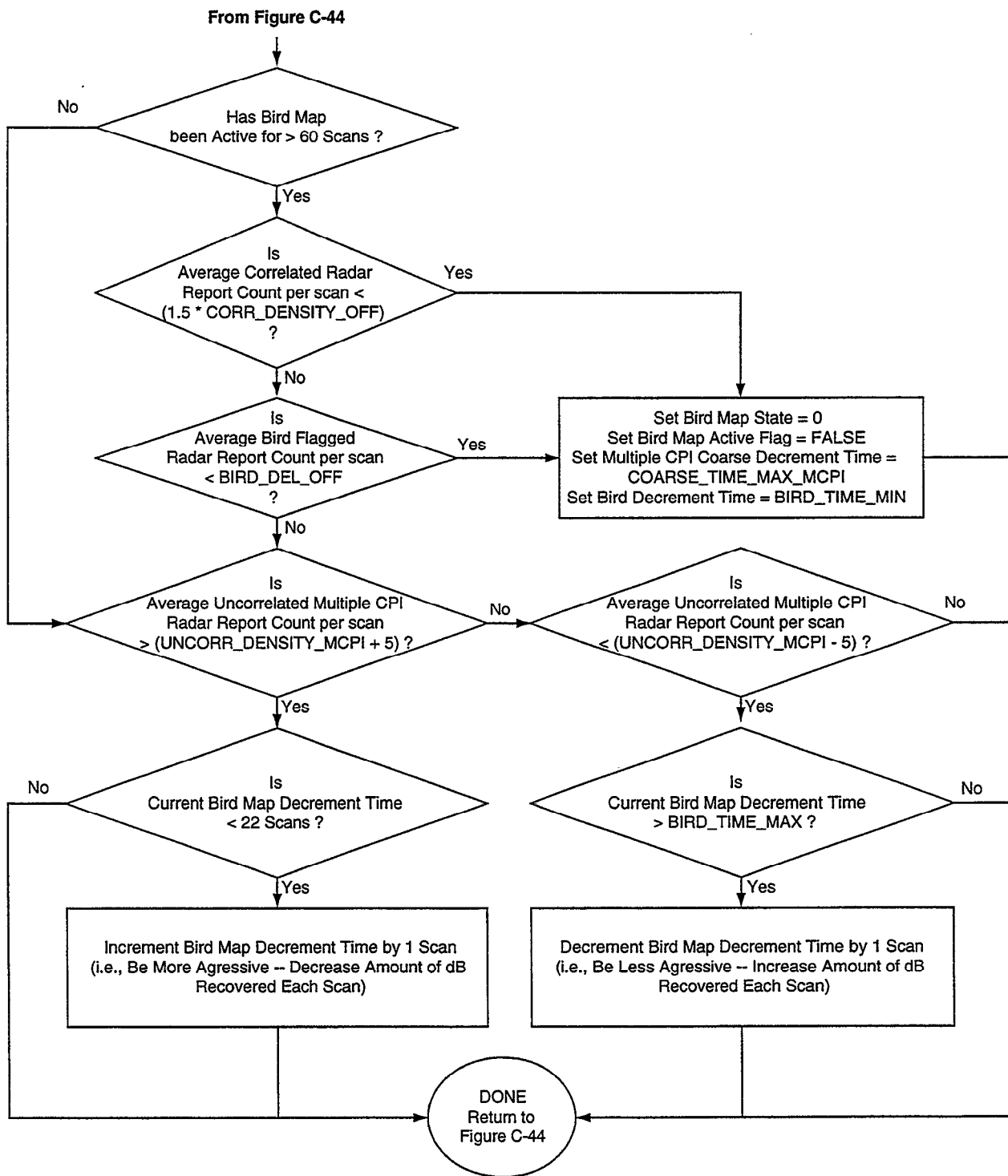

Figure C-49. Bird adaptive map state 4 processing.

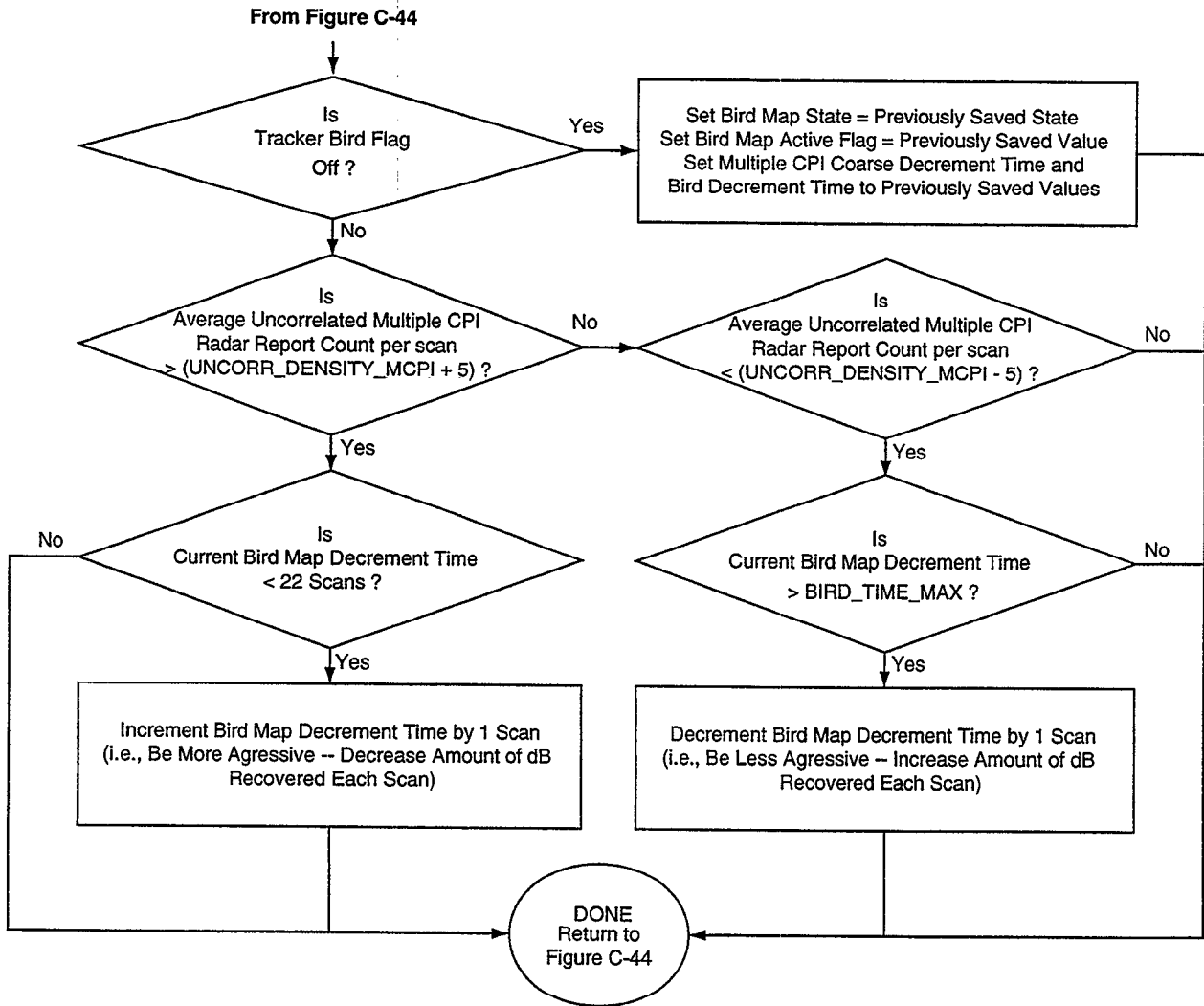

Figure C-50. Bird adaptive map state 5 processing.

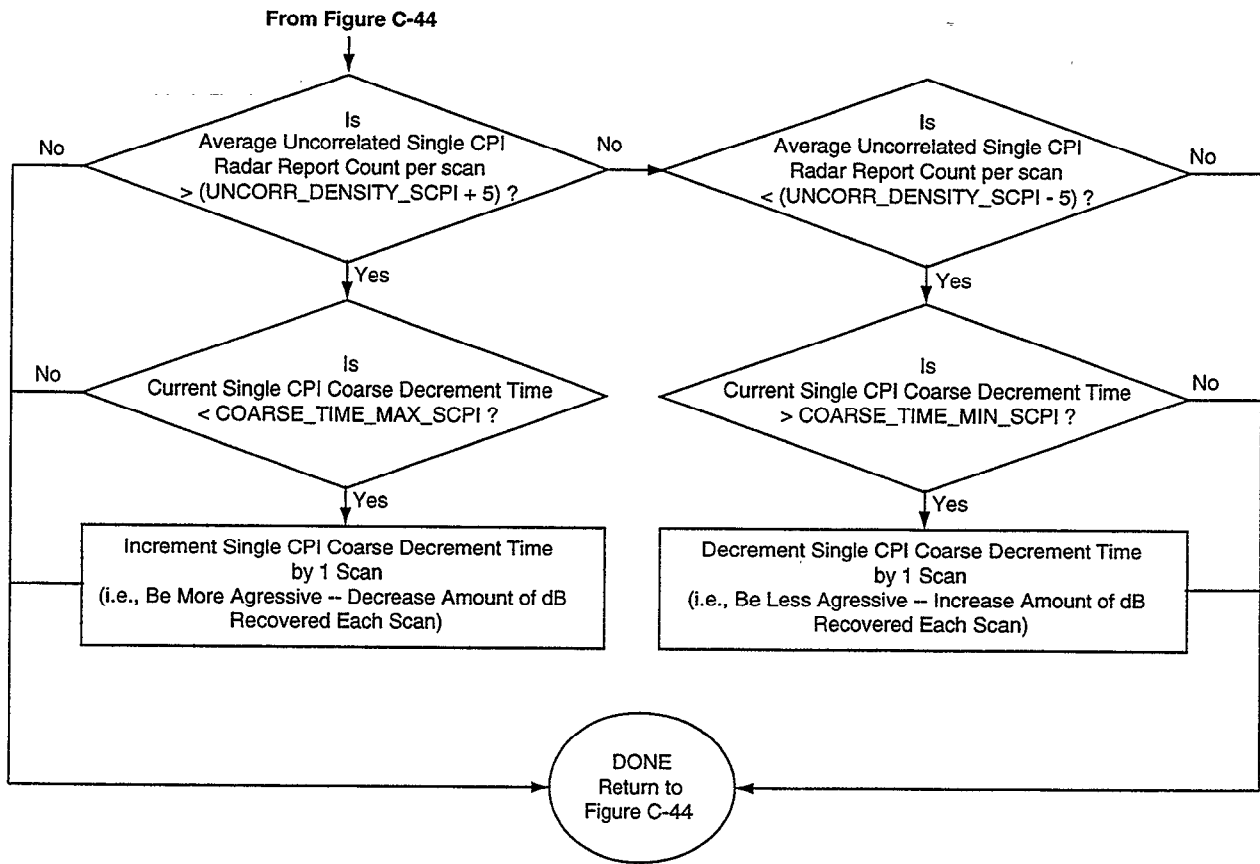
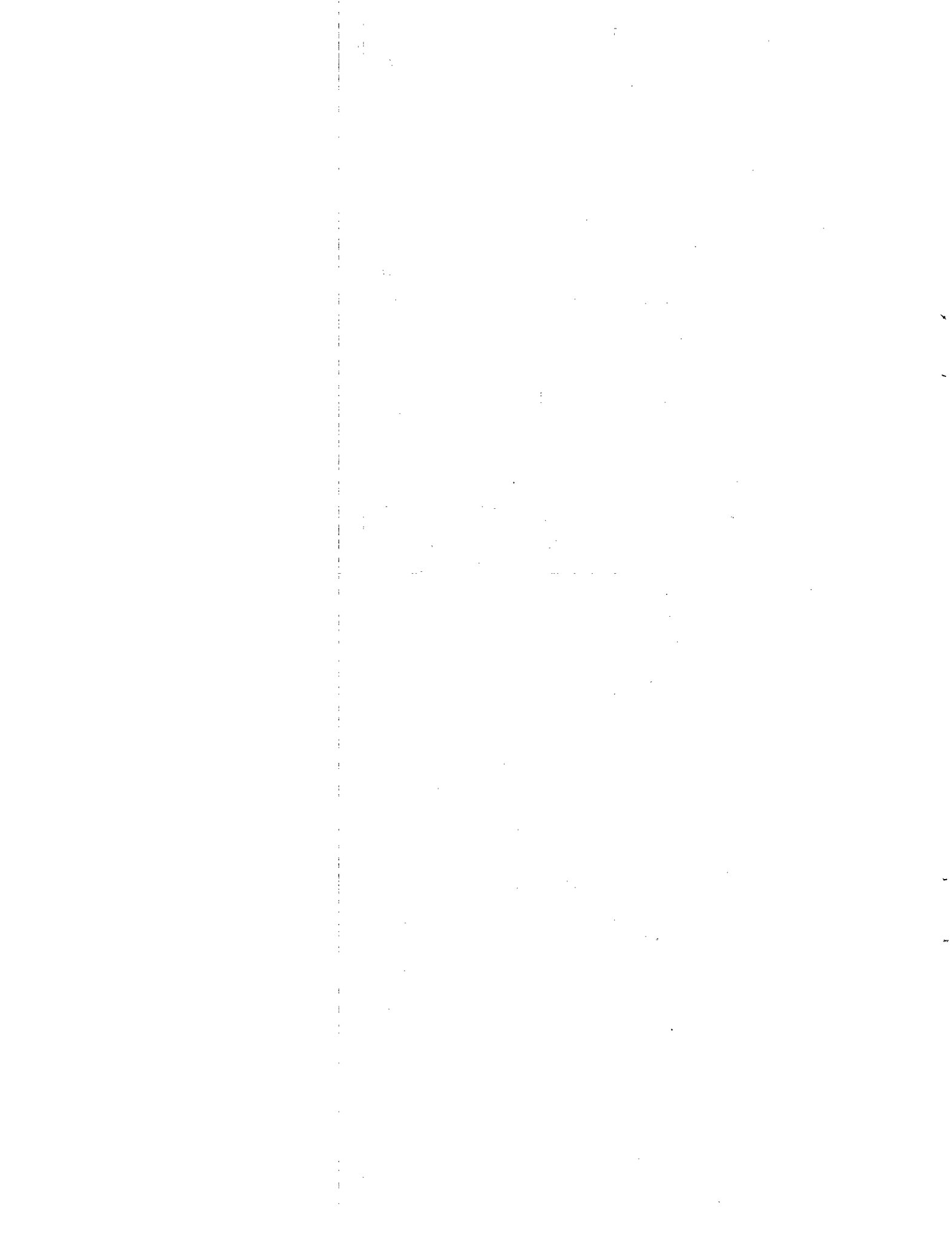

Figure C-51. Single CPI coarse map single scan decrement determination.





## APPENDIX D. INPUT/OUTPUT FORMATS

### INPUT FORMAT

The expected sequence of data types for a single CPIP is shown below. Detailed descriptions of the individual word formats are provided on following pages.

#### C& I Input Format

Az Header
Az Header 1's Complement
Az Data Word 0 - High PRF CPI
Az Data Word 1 - Low PRF CPI
Range Group(s) (0-960)
.
.
WX Header
WX Data (8 words)

#### Range Group Data Block

Range Header
Range Data Word
CPI Data Block(s)
(1 if data exists on only 1 CPI, 2 if data for both CPI's)

#### CPI Data Block

CPI Header (High or Low PRF)
CPI Filter Magnitude Data (0-10 words)

*Figure D-1. CPIP input data layout.*

<b>Az Header</b>	X	X	X	X	X	X	X	X	X	F <sub>6</sub>	F <sub>5</sub>	F <sub>4</sub>	F <sub>3</sub>	0	0	1
------------------	---	---	---	---	---	---	---	---	---	----------------	----------------	----------------	----------------	---	---	---

- F<sub>3</sub> High PRF ZVF Overload Flag. This flag is set (1), if a ZVF overload was detected on the *previous* high PRF CPI.
- F<sub>4</sub> Low PRF ZVF Overload Flag. This flag is set (1), if a ZVF overload was detected on the *previous* low PRF CPI.
- F<sub>5</sub> Short CPI Pair. If set, there were fewer than the required 18 pulses in the previous CPI Pair.
- F<sub>6</sub> Coast Flag. If set, the radar transmitter is off.

<b>Az Header Complement</b>	1's Complement of Az Header Word (above)															
-----------------------------	--	--	--	--	--	--	--	--	--	--	--	--	--	--	--	--

The 1's complement of the azimuth header word immediately follows the header word itself and is used to validate the header

<b>Az Data Word</b>	12-bit Azimuth Position (ACP)												0	0	0	0
---------------------	-------------------------------	--	--	--	--	--	--	--	--	--	--	--	---	---	---	---

Two azimuth data words follow the az complement word, the first containing the antenna azimuth for the high PRF CPI and the second containing the azimuth for the low PRF CPI. Antenna position is given in terms of antenna change pulses (ACPs), with 12-bit accuracy. An ACP of 0 always corresponds to magnetic north. The ACP for the high CPI is sampled at pulse 6, and for the low PRF CPI at pulse 15.

<b>Range Header</b>	11-bit Range Data (LSB = 1/16 nmi)											GZON		0	1	0
---------------------	------------------------------------	--	--	--	--	--	--	--	--	--	--	------	--	---	---	---

- GZON 0 = No geocensoring at this range cell
- 1 = Shaped geocensoring
- 2 = Flat geocensoring
- 3 = MTI reflector

This ASR-9 generated GZON field is ignored by the 9PAC, which instead uses its own internal geocensoring.

Range Data	X	X	X	X	X	X	X	X	X	X	Block Count	0
------------	---	---	---	---	---	---	---	---	---	---	-------------	---

Block Count Number of words of CPI headers + data in the current range block.

CPI Header	X	X	X	X	X	F <sub>10</sub>	F <sub>9</sub>	F <sub>8</sub>	F <sub>7</sub>	F <sub>6</sub>	F <sub>5</sub>	F <sub>4</sub>	F <sub>3</sub>	1	0	1
------------	---	---	---	---	---	-----------------	----------------	----------------	----------------	----------------	----------------	----------------	----------------	---	---	---

- F<sub>3</sub> PRF ( 0 = High PRF CPI, 1 = Low PRF CPI )
- F<sub>4</sub> Saturation Flag (1 = Saturation present)
- F<sub>5</sub> RTQC Flag. If this bit is set to 1, the data for this CPI is from a test target
- F<sub>6</sub> Short CPI Pair (1 = Yes, 0 = No)
- F<sub>7</sub> FIR Filter Selection (1 = Heavy Clutter Filters, 0 = Normal)
- F<sub>8</sub> Beam (1 = High, 0 = Low)
- F<sub>9</sub> -ZVF Delta Crossing
- F<sub>10</sub> +ZVF Delta Crossing

The ZVF Delta crossing flags signify that the clutter exceeded the clutter map threshold plus a 'delta' value (VSP). This has the potential of being used to differentiate 'high confidence' ZVF returns from those that just barely exceed the clutter map threshold. Current ASR-9 practice is to set the 'delta' VSP to 0, so all ZVF primitives will have the flag set.

CPI Data	10-bit Filter Magnitude (LSB = 3/32 dB)	Filter Number	F <sub>1</sub>	0
----------	---	---------------	----------------	---

F<sub>1</sub> Peak filter tag. If set, this is the peak filter output for the CPI

Filter Number The filter number correspondence is as follows:

- |          |           |
|----------|-----------|
| 1 = (-3) | 6 = (+1)  |
| 2 = (-2) | 7 = (+2)  |
| 3 = (-1) | 8 = (+3)  |
| 4 = (-0) | 9 = (+4)  |
| 5 = (+0) | 10 = (-4) |

Wx Header

X	X	X	X	X	X	X	X	X	X	X	F <sub>4</sub>	F <sub>3</sub>	1	1	1
---	---	---	---	---	---	---	---	---	---	---	----------------	----------------	---	---	---

F<sub>3</sub> Weather Level ( 0 = Low, 1 = High ). The level alternates from low to high on successive scans.

F<sub>4</sub> Clear Day Map Mode Bit (0 = Normal Mode, 1 = Clear Day Map Mode). If this bit is set, the smoothing of weather data is inhibited to allow generation of an accurate clear day Wx map.

Wx Data

Wx Detections (15 range cells worth)	0
--------------------------------------	---

Each word of Wx data contains weather detections for 15 1/2 NMI range cells (15 bits where 1 = Wx, 0 = No Wx). A total of 8 words are used to pass the entire 120 range cells of Wx data for each CPI. Cell Range increases from LSB to MSB, and from word 0 to word 7.

## OUTPUT FORMAT

The C&I output report format closely resembles the original 30 word ASP radar target output format, with a few exceptions. A new field, 'Multigrid Adaptive Thresholding Info' has been added in a previously unused word. Other fields were added at the bottom of the report, either because they were required for feedback between the 9PAC C&I, Merge, and Tracker modules, or because they were deemed useful for data analysis. Internally, the C&I code maintains the target reports as a list, requiring the presence of the linked list fields at the start of the report. These words are stripped off by the 9PAC 'glue' code (see ~9pac/comm/src) as part of the output procedure. The 9PAC does not use the 'Track Eligibility' and 'Initial Quality and Confidence' fields, but these fields remain in the output report data structure. The 'Track Eligibility' may still be used by FAA automation system components.

0	Report Type
1	Range
2	Azimuth
3	Runlength
4	Track Eligibility
5	Quality
6	Confidence
7	Max Amplitude
8	Low PRF Max Amplitude Filter Number
9	High PRF Max Amplitude Filter Number
10	ARTSIII Quality
11	High PRF Interpolated Doppler
12	Low PRF Interpolated Doppler
13	Max Amplitude Filter Number
14	Hit/Miss History
15	Flags Word 1
16	Flags Word 2
17	Azimuth Centroiding Algorithm ID
18	Initial Quality and Confidence
19	Multigrid Adaptive Thresholding Info
20	Azimuth Degrade Flag
21	Max Filter Amplitude for (-3) Filter
22	Max Filter Amplitude for (-2) Filter
23	Max Filter Amplitude for (-1) Filter
24	Max Filter Amplitude for (-0) Filter
25	Max Filter Amplitude for (+0) Filter
26	Max Filter Amplitude for (+1) Filter
27	Max Filter Amplitude for (+2) Filter
28	Max Filter Amplitude for (+3) Filter

- 29 Max Filter Amplitude for (-4/+4 combined) Filter
- 30 Low PRF Filter Max Amplitude Count
- 31 High PRF Filter Max Amplitude Count
- 32 Hit/Miss Count
- 33 Weak Target Indicator
- 34 Confidence 0 Deletion Flag
- 35 Radial Velocity
- 36 Bird Deletion Flag
- 37 Low or High PRF Max Amplitude Indicator

Note that in the 9-PAC Phase II Implementation, this format is used internally by the 9PAC, but the actual output format to the MIP is a separate MODE-S compatible format. The translation is done by the I/O processor (not the C&I processor) just prior to outputting the reports to the MIP.

<b>Type</b>	0 0 0 0 0 0 0 0 0 0 0 0 0	$F_3$	0 1 0
-------------	---------------------------	-------	-------

$F_3$  RTQC Flag. Set to 1 if the report is an RTQC target

<b>Range</b>	0 0 0 0	12-bit Range Data (LSB = 1/64 nmi)
--------------	---------	------------------------------------

<b>Azimuth</b>	16-bit Azimuth Data (LSB = 1/16 ACP)
----------------	--------------------------------------

<b>Runlength</b>	12-bit Runlength (LSB = 1 ACP)	0 0 0 0
------------------	--------------------------------	---------

<b>Track Eligibility</b>	0 0 0 0 0 0 0 0 0 0 0 0 0 0	ELIG
--------------------------	-----------------------------	------

- ELIG 0 = No Initiate, no update.  
 1 = No initiate, update ok.  
 2 = Initiate ok, update ok.  
 3 = No initiate, update only if (original ASP) Tracker in states 4, 6-9.

Note: This field is actually not used by the new 9-PAC Tracker but is currently set for backwards compatibility reasons. It may be freed up for other uses at some point.

<b>Report Quality</b>	0 0 0 0 0 0 0 0 0 0 0 0 0 0 0	QUAL
-----------------------	-------------------------------	------

- QUAL 0 = 1 CPI Report (High or Low PRF).  
 1 = 2 CPI Report (High/Low or Low/High PRF combination).  
 2 = 2+ CPI report (one PRF).  
 3 = 3+ CPI (two PRF's)

<b>Report Confidence</b>	0 0 0 0 0 0 0 0 0 0 0 0 0 0	CONF
--------------------------	-----------------------------	------

- CONF 0 = Geocensored (Adaptive Method)  
 1 = Geocensored (Fixed threshold method)  
 2 = RFI Flagged Target  
 3 = NZVF target in zone 1  
 4 = ZVF target  
 5 = NZVF target in zone 2  
 6 = NZVF target excluded from adaptive maps, either due to large amplitude or ambiguous Doppler velocity.  
 7 = Illegal confidence value.

<b>Max Amplitude</b>	0 0 0 0 0 0	10-bit Filter Amplitude (LSB = 3/32 dB)
----------------------	-------------	---

This word contains the maximum filter amplitude contained in the report, using the information stored for both PRFs.

<b>Low PRF Max Amplitude Filter</b>	0 0 0 0 0 0 0 0 0 0 0 0 0	FILTNUM
-------------------------------------	---------------------------	---------

<b>High PRF Max Amplitude Filter</b>	0 0 0 0 0 0 0 0 0 0 0 0 0	FILTNUM
--------------------------------------	---------------------------	---------

- FILTNUM
- |          |           |
|----------|-----------|
| 1 = (-3) | 6 = (+1)  |
| 2 = (-2) | 7 = (+2)  |
| 3 = (-1) | 8 = (+3)  |
| 4 = (-0) | 9 = (+4)  |
| 5 = (+0) | 10 = (-4) |



**ARTSIIIA  
Quality**

0	0	0	0	0	0	0	0	0	0	0	0	0	0	0	ARTSQVAL
---	---	---	---	---	---	---	---	---	---	---	---	---	---	---	----------

**ARTSQVAL**

ARTSIIIA quality value based on a combination of the 'normal' report confidence and quality. Values range from 0 to 7, with the lower numbers (0,1,2) generally representing geocensoring and RFI and higher numbers representing higher quality/confidence data.

**High PRF  
Interpolated Doppler**

0	0	0	0	0	0	0	0	0	0	0	0	6-bit Doppler Value
---	---	---	---	---	---	---	---	---	---	---	---	---------------------

**Low PRF  
Interpolated Doppler**

0	0	0	0	0	0	0	0	0	0	0	0	6-bit Doppler Value
---	---	---	---	---	---	---	---	---	---	---	---	---------------------

The Doppler value is stored as a six-bit signed number scaled to the Nyquist value for the particular PRF.

- 0      Zero Doppler
- 31     Max positive doppler
- 31    Max negative doppler
- 32    Nyquist Doppler (ambiguous)

**Max Amplitude  
Filter Number**

0	0	0	0	0	0	0	0	0	0	0	0	FILTNUM
---	---	---	---	---	---	---	---	---	---	---	---	---------

**FILTNUM**

- 1 = (-3)      6 = (+1)
- 2 = (-2)      7 = (+2)
- 3 = (-1)      8 = (+3)
- 4 = (-0)      9 = (+4)
- 5 = (+0)      10 = (-4)

<b>Hit/Miss History</b>	0 0	14-bit High PRF/Low PRF CPI Hit Bit Mask
-------------------------	-----	--

This field contains a bit mask representing the hit history of a target. As each CPIP of data is incorporated into the target, its previous history is left-shifted by two, and the hit information for the current CPIP is OR'ed into the lowest two bits (Bit 0 is low-PRF, Bit 1 is high PRF). 14-bits provide enough storage for the maximum runlength target (seven CPIs). Examples:

History value: 00000000000001  
 Single CPI target with hit on low PRF

History value: 00000000000111  
 3 CPI target with hits on low-high-low PRF

<b>Flags Word 1</b>	F <sub>15</sub>	F <sub>14</sub>	F <sub>13</sub>	F <sub>12</sub>	F <sub>11</sub>	F <sub>10</sub>	F <sub>9</sub>	F <sub>8</sub>	F <sub>7</sub>	F <sub>6</sub>	F <sub>5</sub>	F <sub>4</sub>	F <sub>3</sub>	F <sub>2</sub>	F <sub>1</sub>	F <sub>0</sub>
---------------------	-----------------	-----------------	-----------------	-----------------	-----------------	-----------------	----------------	----------------	----------------	----------------	----------------	----------------	----------------	----------------	----------------	----------------

- F<sub>0</sub> RTQC Flag. Set to 1 if report is an RTQC target
- F<sub>1</sub> Geocensor MTI Flag
- F<sub>2</sub> Range Straddle Flag.
- F<sub>3</sub> Geocensor (Fixed) Flag
- F<sub>4</sub> Geocensor (Adaptive) Flag
- F<sub>5</sub> Adjacent Cell (Rc-1) Flag
- F<sub>6</sub> Adjacent Cell (Rc+1) Flag
- F<sub>7</sub> Beam Flag ( 0 = Low, 1 = High)
- F<sub>8</sub> Low PRF (Rc) Saturation Flag
- F<sub>9</sub> High PRF (Rc) Saturation Flag
- F<sub>10</sub> Low PRF (Adj) Saturation Flag
- F<sub>11</sub> High PRF (Adj) Saturation Flag
- F<sub>12</sub> Low PRF (Rc) Beamswitch Flag
- F<sub>13</sub> High PRF (Rc) Beamswitch Flag
- F<sub>14</sub> Low PRF (Adj) Beamswitch Flag
- F<sub>15</sub> High PRF (Adj) Beamswitch Flag

**Flags Word 2**

F <sub>15</sub>	F <sub>14</sub>	F <sub>13</sub>	F <sub>12</sub>	F <sub>11</sub>	F <sub>10</sub>	F <sub>9</sub>	F <sub>8</sub>	F <sub>7</sub>	F <sub>6</sub>	F <sub>5</sub>	F <sub>4</sub>	0	0	0	0
-----------------	-----------------	-----------------	-----------------	-----------------	-----------------	----------------	----------------	----------------	----------------	----------------	----------------	---	---	---	---

- F<sub>4</sub> Target Range Split Flag
- F<sub>5</sub> Target Azimuth Split Flag
- F<sub>6</sub> Target Beamshape Split Flag
- F<sub>7</sub> Antenna Speedup Flag
- F<sub>8</sub> Low PRF ZVF- Delta Flag
- F<sub>9</sub> High PRF ZVF- Delta Flag
- F<sub>10</sub> Low PRF ZVF+ Delta Flag
- F<sub>11</sub> High PRF ZVF+ Delta Flag
- F<sub>12</sub> High PRF Interp Dop Test Qualified
- F<sub>13</sub> Low PRF Interp Dop Test Qualified
- F<sub>14</sub> RFI Flag
- F<sub>15</sub> Special Range Split Flag (St. Louis Mod)

**Azimuth Centroid Algorithm**

0	0	0	0	0	0	0	0	0	0	0	0	ALG ID
---	---	---	---	---	---	---	---	---	---	---	---	--------

ALG ID Algorithm ID Ranging from 0-57. See Table D-1 in Appendix D for specific ID meanings

**Initial Quality & Confidence**

0	0	0	0	0	0	0	0	0	0	0	0	INITC	INITQ
---	---	---	---	---	---	---	---	---	---	---	---	-------	-------

- INITQ Same as report quality value (above).
- INITC Initial report confidence value (above), prior to velocity/amplitude exclusion tests.

- The **airport mask** (AM) indicates that the geo cell has been designated as a special cell on an airport runway. Note that this capability is not currently implemented in the software.
- The **elephant flag** (EF) indicates that the cell is an elephant geo cell. Note that an elephant geo cell may or may not have the active flag set. The term "elephant" cell refers to the myth in popular culture that "elephants never forget" – elephant geo cells are more persistent than normal geo cells.
- The **permanent flag** (PF) indicates that the cell is a permanent geo cell – permanent geo cells always have the active flag set.
- The **MTI flag** (MF) indicates that the presence of an MTI reflector.
- The **delete flag** (DF) indicates that the geo cell is allowed to delete qualifying radar reports during target censoring.
- The **new cell flag** (NF) indicates a normal geo cell newly activated (from non-geo status) during the current block.
- The **fixed cell flag** (FF) indicates a hard-coded cell entered by a human operator.

### 5.2.1.2 Geo Cell Types

The report count, active block count, and total block count interact to determine a type for each geo cell. The geo cell type controls its behavior, including whether or not it is active for target censoring, how it is deactivated, and how it is reactivated. There are five types of cells in the geocensor map: non-geo; normal geo; elephant geo; permanent geo; and fixed geo.

- A **non-geo** cell has not met the minimum report density requirement for a single 512-scan block. A non-geo cell is inactive, and therefore cannot be used in target censoring.
- A **normal geo** cell has met the minimum report density requirement during the most recent 512-scan block, and has been declared active for target censoring.
- An **elephant geo** cell has met the single-block minimum report density requirement M-out-of-N times, where M and N are defined by VSPs. An elephant geo cell is active for target censoring if it has satisfied an elephant report density requirement, again a VSP, during the most recent block. Otherwise, the elephant cell would be inactive. An inactive elephant cell becomes active as soon as it satisfies the density requirement. Obviously, one would set the elephant density requirement lower than the normal active density requirement, so that an elephant cell could be activated quickly.
- A **permanent geo** cell has met the elephant M-out-of-N requirement and also has satisfied a percentage requirement with respect to M-out-of-N. A permanent geo cell is always active for target censoring.

**Adaptive Thresh  
Info**

F <sub>15</sub>	F <sub>14</sub>	F <sub>13</sub>	F <sub>12</sub>	F <sub>11</sub>	F <sub>10</sub>	0	0	F <sub>7</sub>	F <sub>6</sub>	0	0	F <sub>3</sub>	0	0	0
-----------------	-----------------	-----------------	-----------------	-----------------	-----------------	---	---	----------------	----------------	---	---	----------------	---	---	---

- F<sub>3</sub> Flag bit indicating that this report failed the medium adaptive map threshold and was deleted. NOTE: Set to 0 for all C&I output reports.
- F<sub>6</sub> Flag bit indicating that this report failed the bird adaptive threshold. Unlike the other adaptive maps, the bird map does NOT delete reports - it just flags them, in order to allow radar/beacon merge processing to occur. Therefore, this bit may be set for C&I output reports.
- F<sub>7</sub> Flag bit indicating that this report failed the fine adaptive map threshold and was deleted. NOTE: Set to 0 for all C&I output reports.
- F<sub>10</sub> Flag bit indicating that this report is located in a Permanent Geo Cell.
- F<sub>11</sub> Flag bit indicating that this report failed the coarse adaptive map threshold and was deleted. NOTE: Set to 0 for all C&I output reports.
- F<sub>12</sub> Flag bit indicating that this report is located in an Active Elephant Geo Cell.
- F<sub>13</sub> Flag bit indicating that this report is located in an Inactive Elephant Geo Cell.
- F<sub>14</sub> Flag bit indicating that this report is a velocity-excluded geo target, which means it has ambiguous Doppler velocity.
- F<sub>15</sub> Flag bit indicating that this report is a velocity-excluded non-geo target, which means it has ambiguous Doppler velocity.

**Azimuth Degrade  
Flag Word**

0	0	0	0	0	0	0	0	0	0	0	0	0	0	0	0	F <sub>0</sub>
---	---	---	---	---	---	---	---	---	---	---	---	---	---	---	---	----------------

- F<sub>0</sub> Single flag used to indicate the data used to form the azimuth estimate was less than optimal. This includes range, azimuth, and beamshape match splits, saturation and beamswitch conditions and targets where the beamshape match split was inhibited due to geocensoring.

**Max Filter  
Amplitudes (9words)**

0	0	0	0	0	0	10-bit Filter Amplitude (LSB = 3/32 dB)									
---	---	---	---	---	---	---	--	--	--	--	--	--	--	--	--

Max amplitude target return for each filter number. For each filter, the maximum value for all data in the target matching the filter number (including both PRF's) is determined. Filters - 4/+4 are combined into 1 value (the maximum value is chosen)

<b>Low PRF Filter Max Count</b>	0 0 0 0 0 0 0 0 0 0 0 0 0 0 0 0
-------------------------------------	---------------------------------

This field is currently not set. It was intended to represent the number of Doppler filters for which the Low PRF had the maximum amplitude.

<b>High PRF Filter Max Count</b>	0 0 0 0 0 0 0 0 0 0 0 0 0 0 0 0
--------------------------------------	---------------------------------

This field is currently not set. It was intended to represent the number of Doppler filters for which the High PRF had the maximum amplitude.

<b>Hit/Miss Count</b>	HI_CNT	0 0 0 0 0 0 0 0	LO_CNT
-----------------------	--------	-----------------	--------

This field contains the number of radar primitives that went into the target for both the low and high PRFs.

LO\_CNT      Number of radar primitives in target for low PRF.

HI\_CNT      Number of radar primitives in target for high PRF.

<b>Weak Target Indicator</b>	0 0 0 0 0 0 0 0 0 0 0 0 0 0 0	F <sub>0</sub>
----------------------------------	-------------------------------	----------------

NOTE: This field is set, but currently not used by 9PAC. It was intended to be used to separate aircraft from birds based on Doppler responses in the radar primitives that make up a target report. It was not found to be useful.

F<sub>0</sub>      This field is set to 1 if the following conditions are true for the radar primitives that make up the target report:

Maximum amplitude is less than 533 (50 dB) AND

There is no gap in Doppler filter responses for adjacent filters AND

No CPI/range gate received responses for > 3 Doppler filters.

<b>Confidence 0 Deletion Flag</b>	0 0 0 0 0 0 0 0 0 0 0 0 0 0 0	F <sub>0</sub>
---------------------------------------	-------------------------------	----------------

F<sub>0</sub>      Flag used to indicate that the report is allowed to be processed by the Merge, but it will be ignored by the Tracker if it is radar-only. All other

reports have set field set to 0.

<b>Radial Velocity</b>	0 0 0 0 0 0	Radial Velocity (LSB = 1 knot)
------------------------	-------------	--------------------------------

Radial velocity of target computed from the Low and High PRF interpolated Doppler values (above).

<b>Bird Deletion Flag</b>	0 0 0 0 0 0 0 0 0 0 0 0 0 0 0	F <sub>0</sub>
---------------------------	-------------------------------	----------------

F<sub>0</sub> Flag used to indicate that the report was flagged by the Adaptive Bird Map because its amplitude was below the Bird Map amplitude threshold. A report with this field set to 1 is allowed to be processed by the Merge, but it will be ignored by the Tracker if it does not merge with a beacon target report. All other reports have this field set to 0.

<b>PRF Max Amplitude Indicator</b>	0 0 0 0 0 0 0 0 0 0 0 0 0 0 0	F <sub>0</sub>
------------------------------------	-------------------------------	----------------

F<sub>0</sub> 0 = Low PRF had the maximum amplitude Doppler filter response.  
1 = High PRF had the maximum amplitude Doppler filter response.

NOTE: This field is currently not carried into the 9PAC Merge.

**Table D-1. Centroid Algorithm IDs**

ID	Algorithm/ Data Type(s)
1	Single CPI (One of the Three High PRF Data Types)
2	Two PRF Interpolation (NZVF_ADJ_HI, NZVF_ADJ_LO)
3	Two PRF Interpolation (NZVF_HI, NZVF_ADJ_LO)
4	Two PRF Interpolation (NZVF_ADJ_HI, NZVF_LO)
5	Two PRF Interpolation (NZVF_HI, NZVF_LO)
6	Single PRF Interpolation (NZVF_ADJ_HI)
7	Single PRF Interpolation (NZVF_ADJ_LO)
8	Single PRF Interpolation (NZVF_HI)
9	Single PRF Interpolation (NZVF_LO)
10	Beamshape Match (NZVF_ADJ_HI)
11	Beamshape Match (NZVF_ADJ_LO)
12	Beamshape Match (NZVF_HI)
13	Beamshape Match (NZVF_LO)
14	Beamsplit (NZVF)
15	Beamsplit (Saturated Data of any type)
16	Single CPI (One of the 3 Low PRF Data Types)
17	Two PRF Interpolation (ZVF_HI, ZVF_LO)
18	Single PRF Interpolation (ZVF_HI)
19	Single PRF Interpolation (ZVF_LO)
20	Beamshape Match (ZVF_HI)
21	Beamshape Match (ZVF_LO)
22	Beamsplit (ZVF)
23	Unused
24	Two PRF Interpolation (NZVF_HI, ZVF_LO)
25	Two PRF Interpolation (ZVF_HI, NZVF_LO)
26	Two PRF Interpolation (NZVF_ADJ_HI, ZVF_LO)
27	Two PRF Interpolation (ZVF_HI, NZVF_ADJ_LO)
28	Beamsplit (Long runlength)
34	Beamshape Match Interpolated Beamsplit (NZVF_ADJ_HI)
35	Beamshape Match Interpolated Beamsplit (NZVF_ADJ_LO)
36	Beamshape Match Interpolated Beamsplit (NZVF_HI)
37	Beamshape Match Interpolated Beamsplit (NZVF_LO)
44	Beamshape Match Interpolated Beamsplit (ZVF_HI)
45	Beamshape Match Interpolated Beamsplit (ZVF_LO)
46	Beamshape Match 1/3,2/3 Beamsplit (NZVF_ADJ_HI)
47	Beamshape Match 1/3,2/3 Beamsplit (NZVF_ADJ_LO)
48	Beamshape Match 1/3,2/3 Beamsplit (NZVF_HI)
49	Beamshape Match 1/3,2/3 Beamsplit (NZVF_LO)
56	Beamshape Match 1/3,2/3 Beamsplit (ZVF_HI)
57	Beamshape Match 1/3,2/3 Beamsplit (ZVF_LO)



## APPENDIX E. C&I CONSTANTS

Tables E-1 through E-3 contain the C&I constants.

**Table E-1. High PRF Doppler Interpolation Constants**

Filter n-1	Filter n	Dop <sub>n</sub>	Dop <sub>avg</sub>	K <sub>n</sub>
-4	-3	40	37	5.191e-2
-3	-2	45	42	4.935e-2
-2	-1	50	47	4.666e-2
-1	-0	59	54	2.618e-2
-0	+0	5	0	2.188e-2
+0	+1	14	10	2.618e-2
+1	+2	19	17	4.666e-2
+2	+3	24	22	4.935e-2
+3	+4	29	27	5.191e-2
+4	-4	35	32	4.459e-2
<b>Modifications for Heavy Clutter Filters</b>				
-2	-1	50	47	4.630e-2
-1	-0	59	54	2.408e-2
+0	+1	14	10	2.408e-2
+1	+2	19	17	4.630e-2

**Table E-2. Low PRF Doppler Interpolation Constants**

Filter (n-1)	Filter n	Dop <sub>n</sub>	Dop <sub>avg</sub>	K <sub>n</sub>
-3	-2	40	38	7.819e-2
-2	-1	47	44	6.766e-2
-1	-0	58	52	3.439e-2
-0	+0	6	0	2.466e-2
+0	+1	17	12	3.439e-2
+1	+2	23	20	6.766e-2
+2	+3	29	26	7.819e-2
+3	-3	35	32	6.766e-2
<b>Modifications for Heavy Clutter Filters</b>				
-2	-1	47	44	5.472e-2
-1	-0	58	52	3.009e-2
+0	+1	17	12	3.009e-2
+1	+2	23	20	5.472e-2

**Table E-3. ASR-9 Low/High Beam Patterns**

<b>ACP From Boresight</b>	<b>Low Beam Gain (3/32 dB units)</b>	<b>High Beam Gain (3/32 dB units)</b>
0	0	0
+/- 1	-2	-2
+/-2	-4	-4
+/-3	-9	-8
+/-4	-15	-14
+/-5	-23	-21
+/-6	-34	-31
+/-7	-45	-41
+/-8	-60	-55
+/-9	-76	-68
+/-10	-96	-86
+/-11	-116	-104
+/-12	-141	-114
+/-13	-168	-135
+/-14	-197	-157
+/-15	-232	-183
+/-16	-268	-209
+/-17	-313	-240
+/-18	-359	-272
+/-19	-418	-308
+/-20	-481	-346
+/-21	-557	-390
+/-22	-647	-437
+/-23	-725	-492
+/-24	-769	-566

## GLOSSARY

9PAC	ASR-9 Processor Augmentation Card
A/D	Analog to Digital
ACP	Azimuth Correction Process
ANSI-C	American National Standards Institute C programming language
ASP	Array Signal Processor
ASR-9	Airport Surveillance Radar, Model 9
ASYNC	Asynchronous
BTD	Beacon Target Detector
C&I	Correlation and Interpolation
CFAR	Constant False-Alarm Rate
CPI	Coherent Processing Interval
CIPI	Coherent Processing Interval Pair
CPU	Central Processing Unit
DRAM	Dynamic Random Access Memory
EEPROM	Electrically Erasable Read-Only Memory
FAA	Federal Aviation Administration
FIR	Finite Impulse Response
HSIB	High Speed Interface Buffer
I and Q	In phase and Quadrature
I/O	Input/Output
IV&V	Independent Verification and Validation
MIP	Message Interface Processor
MTD	Moving Target Detector
MTI	Moving Target Indicator
NZVF	Non-Zero Velocity Filter
PCMCIA	Personal Computer Memory Card International Association
PRF	Pulse Repetition Frequency
R/B	Radar/Beacon target
RAM	Random Access Memory
RFI	Radio Frequency Interference
RMS	Remote Monitoring System
RPM	Revolutions Per Minute
RTQC	Radar Target for Quality Control
SCIP	Surveillance and Communications Interface Processor
STC	Sensitivity Time Control
TRDF	Terminal Radar Development Facility
VSP	Variable Site Parameter
ZVF	Zero Velocity Filter

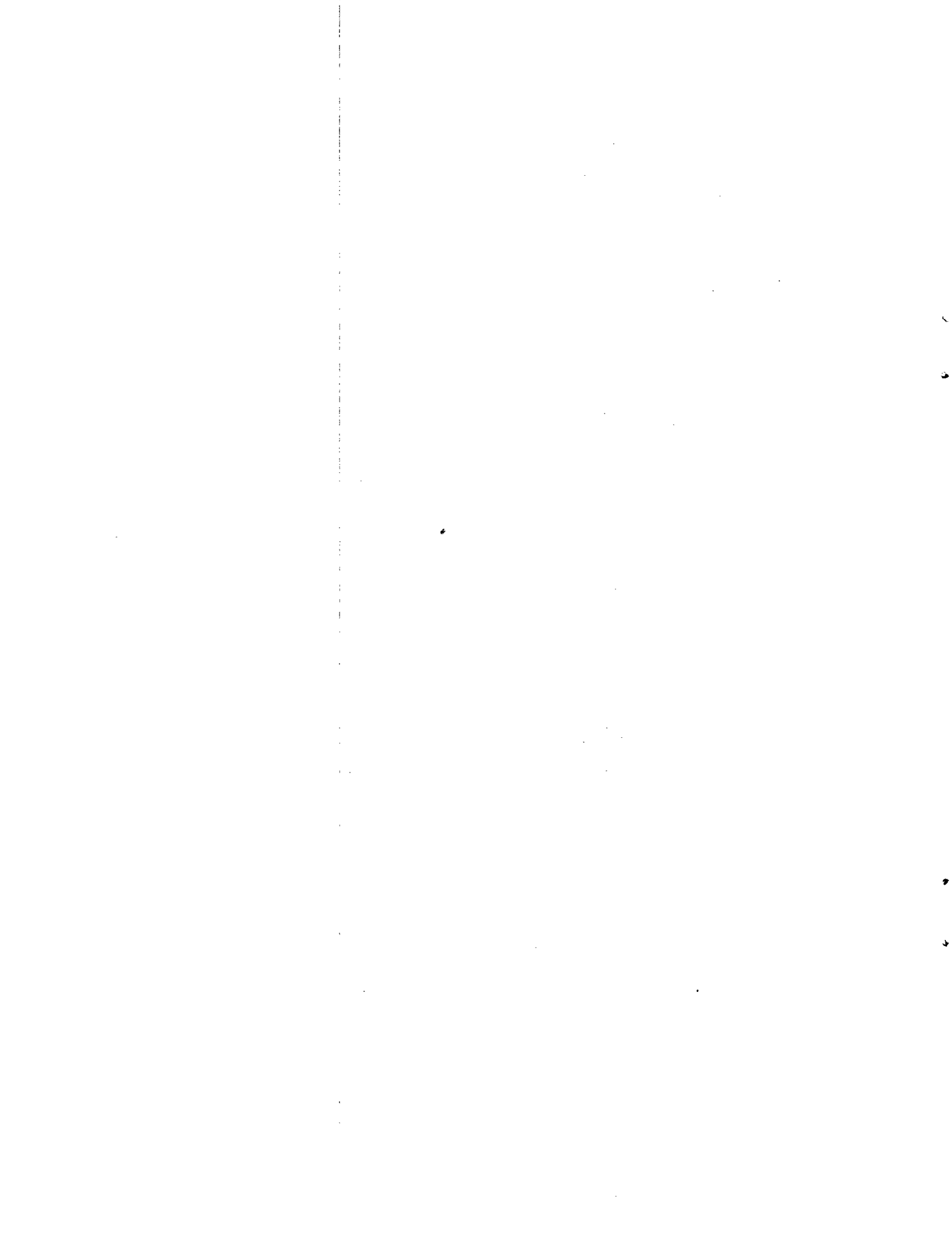

## REFERENCES

- [1] J.V. Pieronek, "The ASR-9 Processor Augmentation Card (9-PAC)," MIT Lincoln Laboratory Project Report ATC-232, October 1995.
- [2] J. Gertz and G.R. Elkin, "Documentation of 9-PAC Beacon Target Detection Processing Function," Lexington, MA, MIT Lincoln Laboratory Project Report ATC-220, 26 July 1994.
- [3] "ASR-9 System Radar Receiver/Processor Instruction/Field Maintenance Manual," Westinghouse Electric Corporation, Baltimore, Maryland, 1989.
- [4] "Moving Target Indicator and Detector Systems - Resident Course Manual 40392-4/2," Federal Aviation Administration Academy, Department of Transportation, Oklahoma City, Oklahoma, 1989.
- [5] "ASR-9 System Definition Document for C&I Algorithms," Westinghouse Electric Corporation, Baltimore, Maryland, 1985.
- [6] D. Karp and J.R. Anderson, "Moving Target Detector (Mod II) Summary Report," Lexington, MA, MIT Lincoln Laboratory Project Report ATC-95, 3 November 1981.
- [7] R.D. Grappel, "Processor Augmentation Card Scan-Scan Correlator Phase II Algorithms," Lexington, MA, MIT Lincoln Laboratory Project Report ATC-298, 26 April 2001.
- [8] G.R. Elkin and J. Gertz, "The Beacon Target Detector (BTD) Algorithms Deployed in the ASR-9 Processor Augmentation Card (9-PAC)," Lexington, MA, MIT Lincoln Laboratory Project Report ATC-288, August 2000.
- [9] G.R. Elkin, "The ASR-9 Processor Augmentation Card (9-PAC) Algorithm Test Bed (SUNPAC) User's Guide," Lexington, MA, MIT Lincoln Laboratory Project Memorandum 92PM-ASR/9-25, 23 November 1999.
- [10] S. Kingsley and S. Quegan, "Understanding Radar Systems," McGraw-Hill, 1992.
- [11] G.R. Elkin and J.B. Evans, "Documentation of 9-PAC Merge Processing Functions," Lexington, MA, MIT Lincoln Laboratory Project Memorandum 42PM-ASR/9-06 (Rev. 1), 8 May 1998.
- [12] O.J. Newell, G.R. Elkin, W.S. Heath, "A 9PAC System Card Application Programmer's Guide," Lexington, MA, MIT Lincoln Laboratory Project Report ATC-267, 16 February 1999.
- [13] E.M. Shank, "Mode S/ASR-9 Options for Advanced Format (ASTERIX) Surveillance Output," Lexington, MA, MIT Lincoln Laboratory Project Memorandum 42PM-SSEG-0001, 8 October 1998.