

DOT/FAA/RD-93/27

**Project Report
ATC-203**

Integrated Terminal Weather System (ITWS) 1992 Annual Report

**J. E. Evans,
Editor**

7 September 1993

Lincoln Laboratory
MASSACHUSETTS INSTITUTE OF TECHNOLOGY
LEXINGTON, MASSACHUSETTS

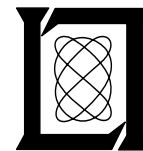

Prepared for the Federal Aviation Administration,
Washington, D.C. 20591

This document is available to the public through
the National Technical Information Service,
Springfield, VA 22161

This document is disseminated under the sponsorship of the Department of Transportation in the interest of information exchange. The United States Government assumes no liability for its contents or use thereof.

1. Report No. ATC-203	2. Government Accession No. DOT/FAA/RD-93/27	3. Recipient's Catalog No.	
4. Title and Subtitle Integrated Terminal Weather System (ITWS) 1992 Annual Report		5. Report Date 7 September 1993	6. Performing Organization Code
7. Author(s) James E. Evans, Editor		8. Performing Organization Report No. ATC-203	
9. Performing Organization Name and Address Lincoln Laboratory, MIT P.O. Box 73 Lexington, MA 02173-9108		10. Work Unit No. (TRAVIS)	11. Contract or Grant No. DTFA-01-91-Z-02036
12. Sponsoring Agency Name and Address Department of Transportation Federal Aviation Administration Systems Research and Development Service Washington, DC 20591		13. Type of Report and Period Covered Project Report, 1992	
15. Supplementary Notes This report is based on studies performed at Lincoln Laboratory, a center for research operated by Massachusetts Institute of Technology under Air Force Contract F19628-90-C-0002.		14. Sponsoring Agency Code	
16. Abstract <p>Hazardous weather in the terminal area is the major cause of aviation system delays as well as a principal cause of air carrier accidents. Several systems presently under development will provide significant increases in terminal safety. However, these systems will not make a major impact on weather-induced delays in the terminal area, meet a number of the safety needs (such as information to support ground deicing decisions), or reduce the workload of the terminal controller.</p> <p>The Integrated Terminal Weather System (ITWS) will provide improved aviation weather information in the allocated TRACON area (up to 50 nmi from the airport) by integrating data and products from various Federal Aviation Administration (FAA) and National Weather Service (NWS) sensors and weather information systems. The data from these sources will be combined to provide a unified set of safety and planning weather products for pilots, controllers, and terminal area traffic managers. By using data from multiple sensors, ITWS can generate important new products where no individual sensor alone could generate a single, reliable product. In other instances, use of data from several sources can compensate for erroneous data from one sensor and thus improve the overall integrity of existing products. Major objectives of the ITWS program are to increase the effective airport acceptance rate in adverse weather by providing information to support terminal automation systems, better terminal route planning, and wake vortex advisory services, and to reduce the need for controllers to communicate weather information to pilots via VHF voice.</p> <p>This report summarizes the work accomplished during fiscal year 1992 on the development of the ITWS initial operational capability products; functional prototype design; operation of testbeds to acquire data for product development and testing; operational evaluation of products by ATC users; investigation of approaches for effective transfer of the technology to the production contractor; transfer of products to pilots via digital data links; and technical support for the ITWS documents required by the General Accounting Office (GAO).</p>			
17. Key Words ITWS gust front airport weather microburst storm motion terminal wind shear lightning Orlando		18. Distribution Statement This document is available to the public through the National Technical Information Service, Springfield, VA 22161.	
19. Security Classif. (of this report) Unclassified	20. Security Classif. (of this page) Unclassified	21. No. of Pages 117	22. Price

ABSTRACT

Hazardous weather in the terminal area is the major cause of aviation system delays as well as a principal cause of air carrier accidents. Several systems currently under development will provide significant increases in terminal safety. However, these systems will not make a major impact on weather-induced delays in the terminal area, meet a number of the safety needs, such as information to support ground deicing decisions, or reduce the workload of the terminal controller.

The Integrated Terminal Weather System (ITWS) will provide improved aviation weather information in the allocated TRACON area (up to 50 nmi from the airport) by integrating data and products from various Federal Aviation Administration (FAA) and National Weather Service (NWS) sensors and weather information systems. The data from these sources will be combined to provide a unified set of safety and planning weather products for pilots, controllers, and terminal area traffic managers. By using data from multiple sensors, ITWS can generate important new products where no individual sensor alone could generate a single, reliable product. In other instances, use of data from several sources can compensate for erroneous data from one sensor and thus improve overall integrity of existing products. Major objectives of the ITWS program are to increase the effective airport acceptance rate in adverse weather by providing information to support terminal automation systems, better terminal route planning, wake vortex advisory services, and to reduce the need for controllers to communicate weather information to pilots via VHF voice.

This report summarizes the work accomplished during fiscal year 1992 on the development of the ITWS initial operational capability products; functional prototype design; operation of testbeds to acquire data for product development and testing; operational evaluation of products by ATC users; investigation of approaches for effective transfer of the technology to the production contractor; transfer of products to pilots via digital data links; and technical support for the ITWS documents required by the General Accounting Office (GAO).

TABLE OF CONTENTS

Section	Page
Abstract	iii
List of Figures	ix
List of Tables	xi
1. INTRODUCTION	1
1.1. Overview	1
1.2. The Integrated Terminal Weather System	1
1.3. Outline of FY92 Report	3
2. INITIAL OPERATIONAL CAPABILITY (IOC) ALGORITHMS	7
2.1. Microburst Detection	7
2.1.1. Background	7
2.1.2. FY92 Accomplishments	7
2.1.3. Shear Map Computation	7
2.1.4. Shear-Based Regions	7
2.1.5. Altitude and Aspect Angle Dependence	8
2.1.6. Location and Size Projection	10
2.1.7. FY93 Plans and Issues	10
2.2. Microburst Prediction	10
2.2.1. Background	10
2.2.2. FY92 Accomplishments	14
2.2.3. FY93 Plans and Issues	17
2.3. Vertical Wind Shear	17
2.3.1. Background	17
2.3.2. FY92 Accomplishments	17
2.3.3. FY93 Plans and Issues	18
2.4. Gust Front/Wind Shift	19
2.5. TDWR Gridded Winds and Reflectivity	19
2.6. ITWS Terminal Winds	20
2.6.1. Background	20
2.6.2. FY92 Accomplishments	21
2.6.3. FY93 Plans and Issues	29
2.7. Storm Motion/Snow-Storm Motion	30
2.7.1. Background	30
2.7.2. FY92 Accomplishments	31
2.7.3. FY93 Plans and Issues	31
2.8. Terminal Weather-Impacted Airspace (WIA) Algorithm	32
2.8.1. FY92 Accomplishments	34

**TABLE OF CONTENTS
(Continued)**

<u>Section</u>	<u>Page</u>
2.8.2. Work for End-State WIA	38
2.8.3. FY93 Plans and Issues	38
2.9. Lightning Detection	39
2.9.1. Background	39
2.9.2. FY92 Accomplishments	40
3. PROTOTYPE DESIGN	47
3.1. Background	47
3.2. FY92 Accomplishments	47
3.3. FY93 Plans and Issues	47
4. TESTBED OPERATIONS/DATA ACQUISITION	49
4.1. Sensor System/Recording	49
4.2. Summary of Wind Shear Events/Singular Weather Events (FL-2)	49
4.3. FY93 Plans	55
5. PRODUCT OPERATIONAL ASSESSMENT	57
5.1. Operational Evaluation of High-Resolution Lighting Data at United Airlines Ground Operations Center in Orlando, FL	57
5.1.1. Background	57
5.1.2. FY92 Accomplishments	57
5.1.3. FY93 Plans and Issues	58
5.2. Products at CWSU/TMS	58
5.2.1. Background	58
5.2.2. Observer Results	58
5.3. FY93 Plans	59
6. TECHNOLOGY TRANSFER	65
6.1. Specification	65
6.2. CASE Tools/C++	66
6.3. Plans for Hamilton	68
7. PILOT DATA LINK	69
7.1. Background	69
7.1.1. FY92 Accomplishments	69
7.1.2. FY93 Plans and Issues	70

TABLE OF CONTENTS
(Continued)

Section	Page
8. TECHNICAL SUPPORT	73
8.1. Alternative analysis	73
8.1.1. Background	73
8.1.2. FY92 Accomplishments	73
8.1.3. FY93 Plans and Issues	73
8.2. Functional requirements	73
8.2.1. Background	73
8.2.2. FY92 Accomplishments	74
8.2.3. FY93 Plans	75
8.3. Operational concept	75
8.3.1. Background	75
8.3.2. FY92 Accomplishments	76
8.3.3. FY93 Plans	80
8.4. Cost/Benefits	80
8.5. Product Data Requirements	84
8.5.1. Background	84
8.5.2. FY92 Accomplishments	84
8.5.3. FY93 Plans	84
8.6. Acquisition Plan Support	85
8.6.1. Background	85
8.6.2. FY92 Accomplishments	85
8.6.3. FY93 Plans	86
8.7. Master Test Plan	86
8.7.1. Background	86
8.7.2. FY92 Accomplishments	86
8.7.3. FY93 Plans and Issues	87
9. SUMMARY	89
GLOSSARY	91
REFERENCES	95

LIST OF FIGURES

Figure	Page
1. Data from FAA, NWS, and other sensing systems combined by the ITWS processor to provide safety and planning products for terminal air traffic managers.	2
2. Principal ITWS accomplishments in FY92.	4
3. Focus of FY93 ITWS program.	5
4. Shear map generation process.	8
5. Comparison of the microburst alert shapes output from the (a) ITWS algorithms.	9
6. Motion of a strong Kansas City microburst as taken from the ITWS shear regions algorithm.	11
7. Proposed ITWS microburst shape display (loss value on top and F factor on bottom of label).	12
8. Proposed ITWS microburst trend message display.	12
9. Illustration of improved safety and planning possible with microburst prediction product.	12
10. Schematic showing the microburst prediction analysis and display system.	15
11. Graph showing VIL and height of the center of mass relative to the surface differential velocity (ΔV) computed by the microburst prediction analysis system for one of the microbursts on August 27, 1990 in Orlando.	16
12. T-LAPS cascade of scales.	22
13. The boundaries of the T-LAPS analysis regions near Orlando International Airport.	23
14. The T-LAPS analyzed wind field at 21:30 GMT on 20 August 1992.	25
15. The T-LAPS analyzed wind field at 21:50 GMT on 20 August 1992.	27
16. Preliminary performance evaluation.	29
17. Development of correlation tracking algorithm.	32

**LIST OF FIGURES
(Continued)**

Figure	Page
18. Terminal WIA algorithm logic.	33
19. Example of weather data illustrating the need to create a mosaic of ASR-9 and pencil-beam radar data.	35
20. ASR-9 radars underestimation of intensities of storms located near to (~25 km) and far away from (~100 km) the radar.	37
21. Flash rate, vertically integrated liquid water content (VIL) and average updraft in the mixed phase regions (5 km to 8 km altitude) versus time during an isolated thunderstorm on 18 August 1992.	41
22. Vertical cross sections of reflectivity in a north-south oriented plane.	43
23. Volume reflectivity of significant storm parameters during intensifying phase of the thunderstorm.	45
24. Functional prototype architecture.	48
25. 1992 Orlando monthly distribution of microbursts and gust fronts.	50
26. Distribution of maximum radial velocity in 1992 Orlando microbursts.	51
27. Minute-by-minute distribution of average radial shear in 1992 Orlando microbursts.	52
28. Minute-by-minute distribution of F factor in 1992 Orlando microbursts.	53
29. Minute-by-minute plot of F factor for a severe microburst on July 7, 1992.	55
30. Dallas-Ft. Worth ITWS testbed for summer 1993.	56
31. Weather radar and lightning display provided to United Airlines Ground Operations Center at MCO.	61
32. Sample diagram from the StP CASE tool.	67
33. Orlando ACARS demonstration.	70
34. Terminal area operations supported by ITWS.	79
35. Methodology for estimation of annual delay at major U.S. airports attributable to weather.	82
36. Principal ITWS technical issues for testing.	86
37. Principal ITWS operational issues.	87

LIST OF TABLES

Table		Page
1	Summary of Dates for which Data was Collected from ITWS Sensors (Orlando, 1992)	49
2	1993 Orlando ITWS Demonstration Products	63
3	1993 Dallas–Ft. Worth Demonstration Products	63
4	Impact of ITWS on Airspace Organization	80
5	Estimates of Annual Serious (at least 15 minutes duration) Delay Attributable to Various Types of Weather at Ten Most Active U.S. Airports	82
6	Breakdown of Average Daily Weather Delay Minutes by Flight Phase for Weather at O'Hare International Airport	83

1. INTRODUCTION

1.1. OVERVIEW

Terminal area weather is the major cause of aviation system delays as well as a principal cause of air carrier accidents. The deployment (which is underway) of the Terminal Doppler Weather Radar (TDWR), enhanced Low Level Wind Shear Alert System (LLWAS), the ASR-9 Weather Channel, and the ASR-9 with a Wind Shear Processor (WSP) augmentation will provide significant increases in terminal safety. However, these systems will not make a major impact on weather-induced delays in the terminal area. Additionally, there are a number of unmet safety needs in the terminal area, such as the need for information to support ground deicing decisions. Finally, there is an urgent need to reduce the terminal controller workload.

The Integrated Terminal Weather System (ITWS) will provide improved aviation weather information in the terminal area by integrating data and products from various Federal Aviation Administration (FAA) and National Weather Service (NWS) sensors and weather information systems. A key objective of the ITWS program is to increase the effective airport acceptance rate in adverse weather by providing information to support terminal automation systems (e.g., the Terminal Area Traffic Control Automation (TATCA) Center-TRACON Advisory System (CTAS)), better terminal route planning, and wake vortex advisory services. Controller workload will be reduced by proactive route planning, providing tailored, timely information to pilots directly by data link, and by reducing the need for controller interpretation of weather reflectivity images. Safety will be enhanced by providing early wind shear warnings, identifying hazardous storms, and providing support for ground deicing decisions.

1.2. THE INTEGRATED TERMINAL WEATHER SYSTEM

The ITWS is a processor that will acquire data from the various FAA and NWS weather sensing systems located in and near the terminal area. The data from these sources will be combined with products from other systems [e.g., National Weather Service Forecast Office (NWSFO) and the regional Aviation Weather Products Generator (AWPG)] to provide a unified set of safety and planning weather products for pilots, controllers, and terminal area traffic managers to use in the terminal area. Combined data also will be used by other terminal capacity improvement systems (e.g., TATCA CTAS and wake vortex). Figure 1 illustrates this combining process for some of the major ITWS data sources and users.

The ITWS can generate important new products (e.g., 3D winds, hail storm identification, predictions of microburst strength, and ceiling/visibility changes) by using data from multiple sensors (e.g., TDWR, LLWAS, Aircraft Communications Addressing and Reporting System (ACARS), and Automated Surface Observing System (ASOS)) in cases where no individual sensor alone could generate a reliable product. In other cases, use of data from several sources can compensate for erroneous data from one sensor and thus improve overall integrity of existing products. For example, the ASR-9 weather channel provides rapid updates of reflectivity in the terminal area but may display ground clutter in anomalous propagation conditions [1]. Use of 3D reflectivity data from pencil-beam radars such as TDWR and Next Generation Weather Radar (NEXRAD) can identify where ground clutter is con-

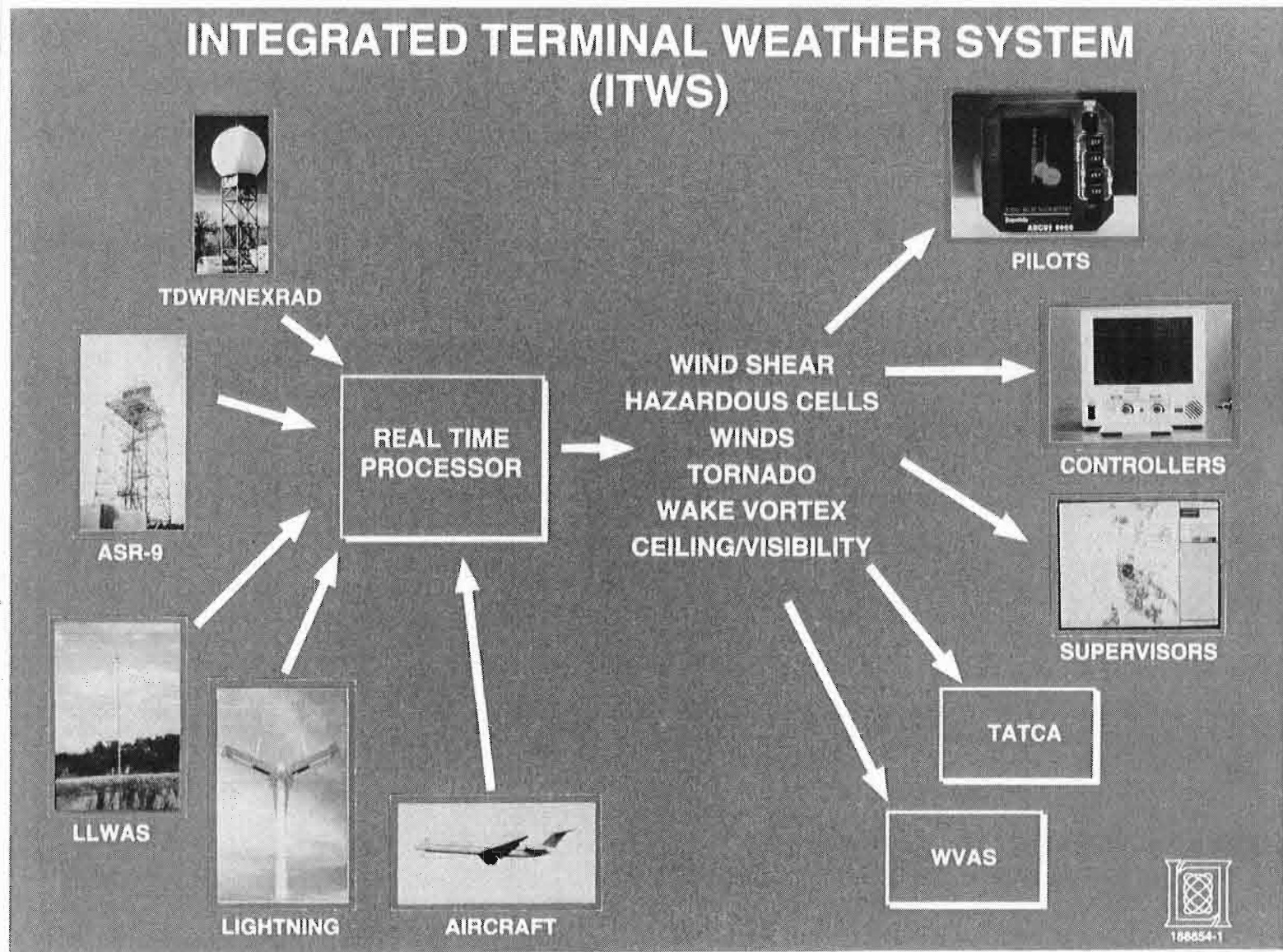

Figure 1. Data from FAA, NWS, and other sensing systems combined by the ITWS processor to provide safety and planning products for terminal air traffic managers.

tminating the weather channel output and hence reduce the need for extensive controller/pilot discussions to identify erroneous data.

The geographical domain of the ITWS is the entire allocated TRACON area (e.g., up to 50 nmi from the airport). When the advanced automation system (AAS) is fully deployed, ITWS will interface with the area control computer complex (ACCC) TRACON function through the terminal control computer complex (TCCC). At airports where the ACCC/TCCC systems have not yet been deployed, the ITWS will provide weather information to air traffic controllers (ATC) and terminal area managers through geographic situation displays and alphanumeric displays, similar to the displays used for the TDWR program. The weather information to support time-based terminal flight path planning and wake vortex separation will be provided directly to the TATCA and wake vortex advisory systems.

A major objective of the ITWS is to reduce the need for controllers to provide weather information to pilots via VHF voice. Information to be disseminated via the automatic terminal information system (ATIS) will be provided directly to the ATIS workstation. In addition, the ITWS will facilitate direct weather product dissemination to pilots by providing tailored text and graphics products through a variety of interfaces to digital data links.

1.3. OUTLINE OF FY92 REPORT

This report summarizes the work accomplished during fiscal year 1992 (FY92) under the various tasks identified in the Lincoln ITWS Work Breakdown Structure (WBS):

1. Development of the ITWS initial operational capability products,
2. ITWS functional prototype design,
3. Operation of ITWS testbeds to acquire data for product development and testing,
4. Operational evaluation of ITWS products by ATC users,
5. Investigation of approaches for effective transfer of the Lincoln-developed ITWS technology to the ITWS production contractor,
6. Transfer of ITWS products to pilots via digital data links, and
7. Technical support for the ITWS documents required by the General Accounting Office (GAO) Advisory Circular 109 (A-109).

Each of the major WBS areas is described in a chapter of this report. Each task discussion provides a background for the task, discusses the FY92 accomplishments, and briefly outlines the focus for 1993 activity.

Figure 2 summarizes the principal accomplishments in FY92. Substantial progress was made in the product generation algorithms which represent the highest risk area in ITWS development, inasmuch as the bulk of the desired capability has not been demonstrated heretofore. The principal objectives for data acquisition were achieved, and useful feedback on ITWS products was obtained from United Airlines and the Jacksonville, FL Center Weather Service Unit (CWSU) and Traffic Management Unit (TMU).

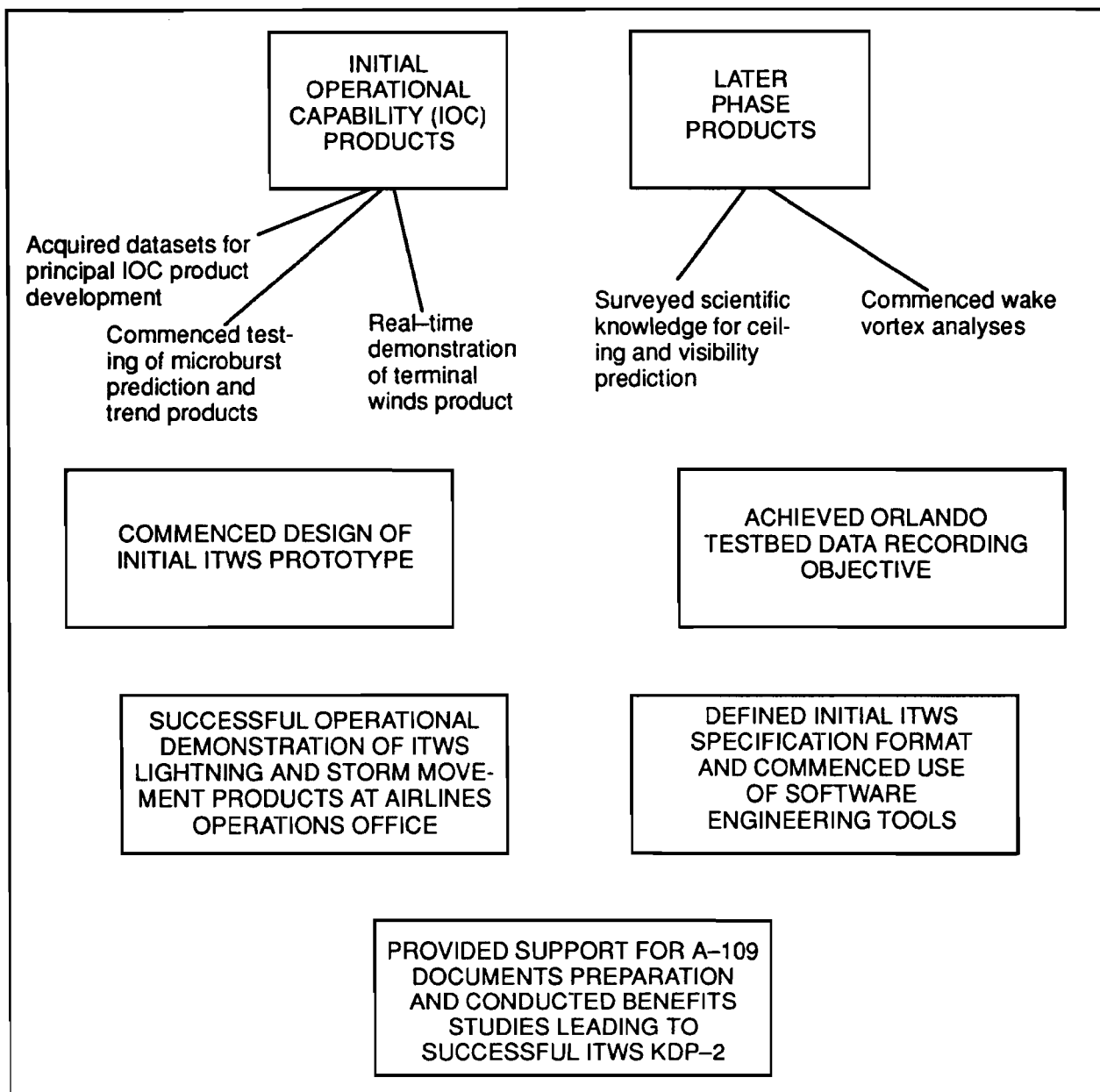

Figure 2. Principal ITWS accomplishments in FY92.

As a by-product of the real-time terminal winds demonstration, real-time access to the FAA NEXRAD base product port was established.

A number of approaches for technology transfer were used during FY92, such as templates for algorithm specification, the use of Computer Aided Software Engineering (CASE) tools, and object-oriented languages (C++). Progress was made in achieving a real-time digital data link transfer of ITWS products to pilots, and support was provided for preparation of the ITWS A-109 documents required for the successful Key Decision Point (KDP-2) review held in December 1992.

Figure 3 summarizes the planned ITWS activity in FY93. The initial operational capability (IOC) product generation algorithms will be brought to an operationally useful technical performance capability. A functional prototype will be developed to support real-time testing and operational demonstration of ITWS products at Orlando (MCO) and Dallas-Ft. Worth (DFW).

An executable specification language developed by a commercial firm will be evaluated in the context of ITWS algorithm development. Real-time transfer of wind shear and hazardous cell information to pilots by the ACARS data link will be demonstrated. Technical support for A-109 studies and documentation will continue in a number of areas.

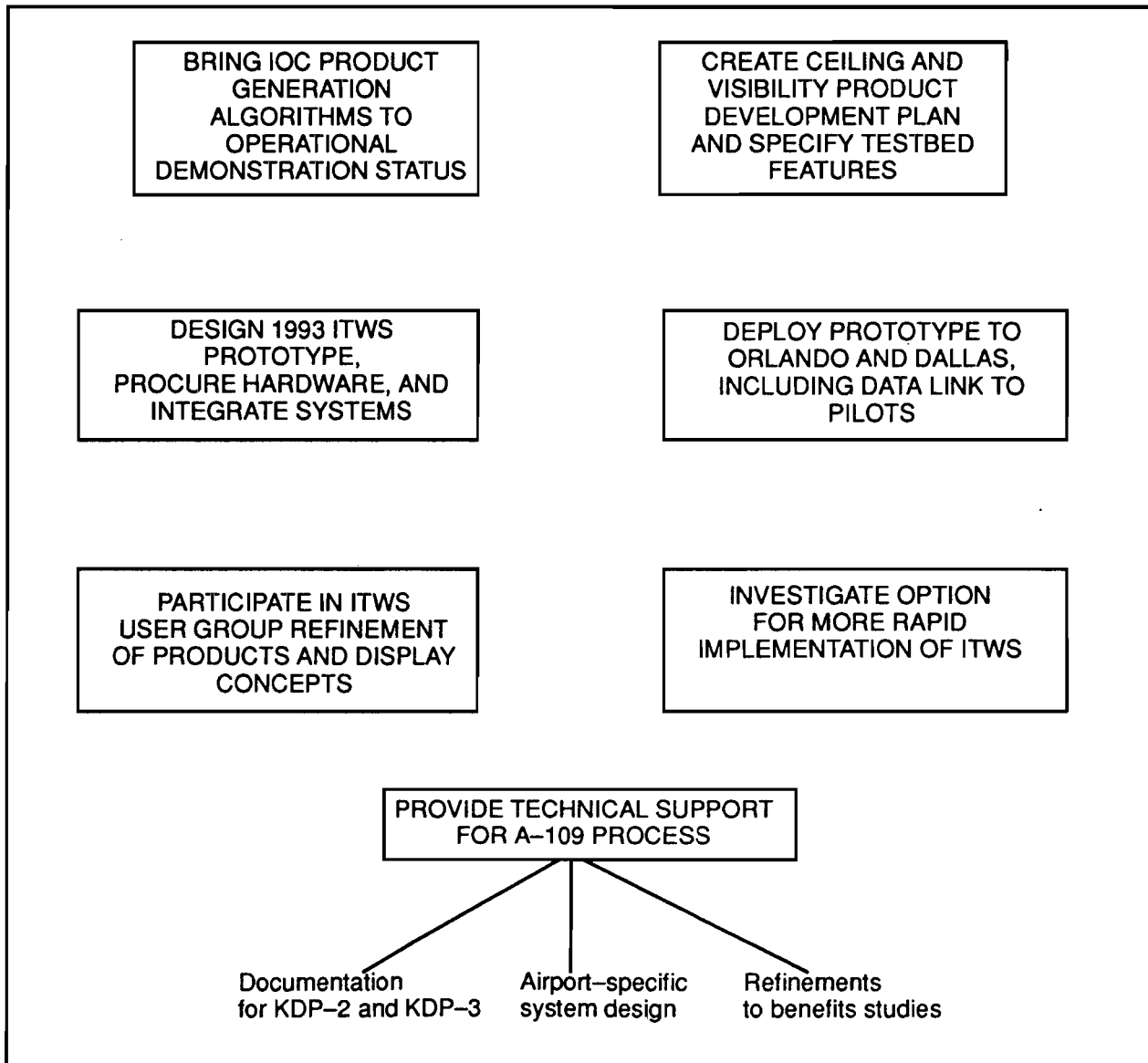

Figure 3. Focus of FY93 ITWS program.

2. INITIAL OPERATIONAL CAPABILITY (IOC) ALGORITHMS

2.1. MICROBURST DETECTION

2.1.1. Background

The ITWS will provide a significantly improved microburst detection capability over present systems such as TDWR. The ITWS microburst detection algorithm will provide a more accurate hazard characterization by employing shear-based detection methods. These methods will allow the microburst hazard to be quantified in the same terms as airborne wind shear detection systems (i.e., in terms of F factor [2]). Providing the hazard estimate in terms of the F factor relates the microburst intensity directly to aircraft performance and makes the ITWS microburst alert compatible for cockpit display via ground-to-air data link (see related discussion in Pilot Data Link, Section 7.).

The shear-based detection approach will further improve the characterization of microburst hazards by identifying small regions of intense shear ("hot spots") which are not well localized by the current algorithm. The new algorithm also will improve the accuracy of hazard characterization by compensating for the effects of altitude dependence and asymmetry in the outflow intensity. A high priority will be given to providing consistency of the ITWS alerts with both TWDR and LLWAS, using the data from both sensors as input to the algorithm.

The microburst trend algorithm will provide additional capabilities by projecting the future locations, sizes and intensities of microburst outflows and warning users of increasing microburst impact along runway corridors. This product should be a helpful decision-making tool for pilots. A warning of increasing trend will be created from a combination of motion, growth in extent, and internal microburst intensification, and so each of these factors needs to be considered in the algorithm design.

2.1.2. FY92 Accomplishments

Significant progress was made in the development of the prototype algorithm. A shear computation scheme and a shear-based region detection algorithm were developed. Work was performed on tracking as a prelude to microburst projection.

2.1.3. Shear Map Computation

The F factor is directly proportional to the microburst alert shear ($\Delta V/\Delta R$). Accordingly, a method was developed for computing the shear from polar velocity data using a least-squares method. The velocity data is first smoothed using a 0.5 km x 0.5 km median filter, then the shear is computed as the slope of a least-squares fit line to the velocity data centered on a seven-gate window. For the seven-gate window with the 150 m TDWR gate spacing, the width of the window is 0.9 km (6 gates x 150 m/gate). This method is similar to an approach developed by Dr. Charles Britt of Research Triangle Institute for NASA Langley-sponsored work in microburst detection with airborne Doppler weather radars. This shear map generation process is summarized in Figure 4.

2.1.4. Shear-Based Regions

An algorithm is being designed to isolate high and moderate shear regions from the shear map. These regions can then be tested further to see whether they meet additional crite-

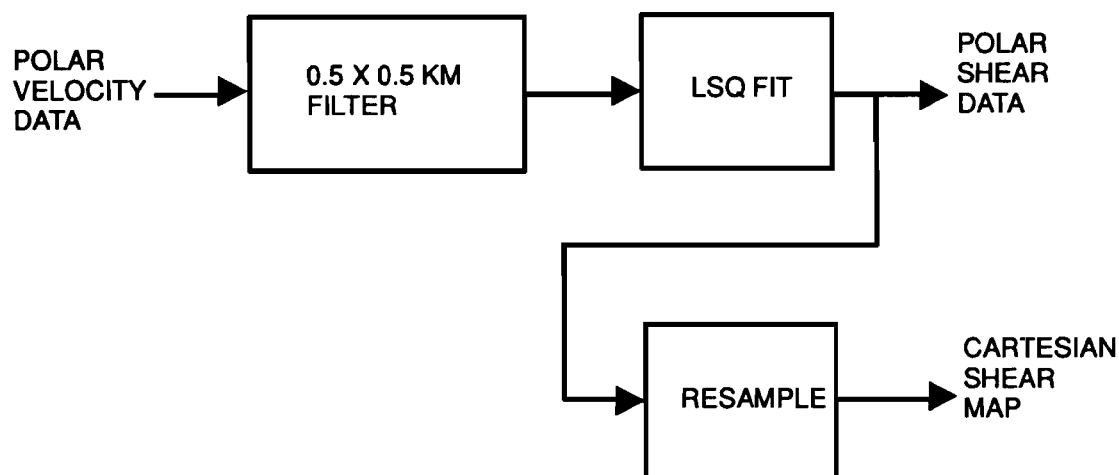

Figure 4. Shear map generation process.

ria for a microburst or wind shear alert. This shear region's algorithm operates by localizing segments of positive shear at two or more threshold levels, where the threshold is relaxed to allow subthreshold gates within a segment, provided other criteria are met. Adjacent segments are grouped into regions and declared viable if they are sufficiently large. High shear regions are then associated with moderate shear regions, and moderate shear regions are assigned event numbers based on a correlation with earlier times. The algorithm is able to follow events through splits and merges, whether real (as some merges are) or artifacts of the localization and association process.

Figure 5 shows an 8/18/90 Orlando microburst as detected by both the TDWR and the ITWS microburst detection algorithms, superimposed on a shear map. The low shear and high shear outlines correspond to an F factor of approximately 0.05 and 0.1, respectively. The hazardous extent of this particular event is well characterized by either algorithm, but the ITWS algorithm clearly points out a high shear area which is much more dangerous than the other portions of the event. The ITWS algorithm also makes it clear that there is only one microburst present, something which becomes critical when attempting the microburst trend algorithm. Internal evaluation of the TDWR algorithm in Orlando has shown that it has the inclination to overestimate the spatial extent of microbursts. The shear-based approach appears to alleviate some of this overwarning, at least in the cases analyzed thus far.

2.1.5. Altitude and Aspect Angle Dependence

The effects of altitude on microburst outflow intensity were analyzed through simultaneous radar measurements and aircraft penetrations. Additionally, cases were analyzed with a high density of surface outflow scans. In general, outflow F factor and loss changes with altitude were in agreement with physical models.

Models of interacting microbursts were used to examine the role of radar viewing angle in microburst detection. The models were examined from simulated radar views, shear maps were constructed, and shear regions created. The results indicate that these models of sym-

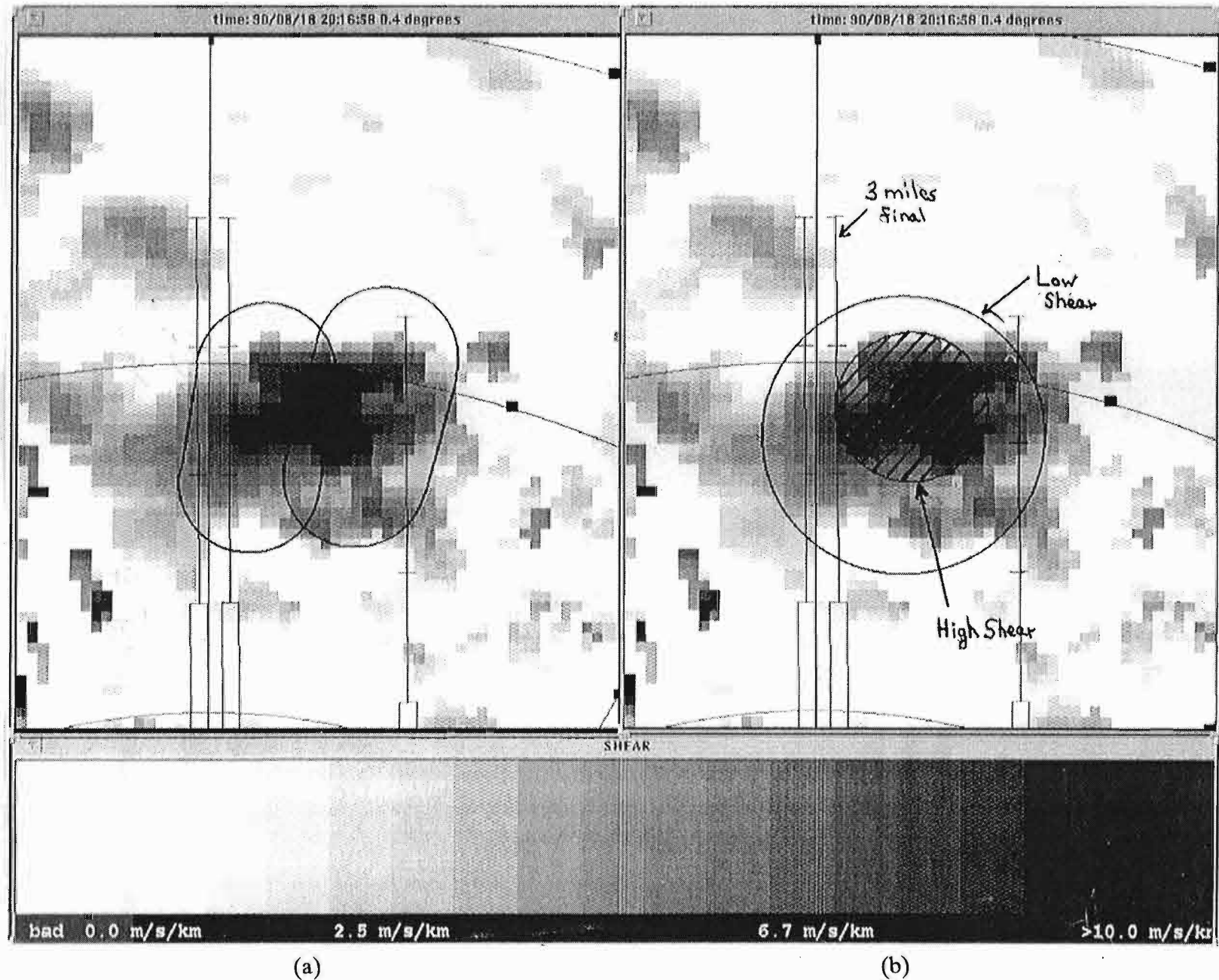

Figure 5. Comparison of the microburst alert shapes output from the (a) TDWR and the (b) ITWS algorithms. The gray scale represents positive radial shear from lowest (white) to highest (black).

metric interacting microbursts were correctly localized in size and number by the shear regions algorithm, regardless of radar viewing angle.

2.1.6. Location and Size Projection

Several case studies were made of the tracks of microbursts identified with the ITWS microburst detection algorithm. The track for a 7/18/89 Kansas City microburst which reached 50 knots with a peak F factor of over 0.20 is shown in Figure 6. It is clear from plots from this and other cases that a microburst location projection algorithm can be quite accurate while relying only upon past track information.

A similar analysis was performed on the size history of microbursts. In most cases of isolated microbursts, detected sizes are monotonically increasing with time. More complex scenarios with multiple interacting microbursts will require improvements in the detection algorithm output, a subject of considerable effort in the coming year.

2.1.7. FY93 Plans and Issues

The 1993 fiscal year presents the first opportunity for a real-time demonstration of the ITWS microburst detection algorithms, slated for June through August at the Orlando ITWS testbed. Both of the Phase I microburst detection and trend algorithms are to be run off line. This will require a significant effort toward fine-tuning the existing microburst detection software for real-time demonstration, as well as development of an initial microburst trend product. Much of the time during the summer operations will be spent developing scoring software and performing data analysis of particularly interesting cases.

Figure 7 illustrates the form of the shapes which will be shown on the Geographic Situation Display (GSD) by the Phase I algorithms. A hollow circle will indicate a wind shear event, a cross-hatched circle will depict a microburst, and a filled circle inside the outer microburst shape will indicate a microburst with an enclosed strong shear region. Each case will include text with the maximum loss and F factor within the shape. The trend operational concept is shown in Figure 8. The idea is that the combined influence of motion, growth, and intensity changes will be integrated along the runway corridor to provide a two-minute warning of an increase in microburst hazard. This increasing trend message will be a simple character addition to the text message.

The coming year will mark the maturation of the algorithms, where both additional sensors and other ITWS products will be used extensively. The microburst prediction product team is expected to be a large contributor to the Phase I microburst trend product. A data fusion strategy is to be formulated which will incorporate LLWAS sensor data and products into the microburst detection algorithm, as well as other nearby TDWRs and NEXRADs. This data fusion is essential for ensuring consistency of the ITWS alerts with existing products and for understanding microburst asymmetry.

2.2. MICROBURST PREDICTION

2.2.1. Background

The ITWS microburst prediction product is intended 1) to help in managing air traffic efficiently in the terminal area while minimizing impact on controller workload when micro-

7/18/89 Event #45 Location Track

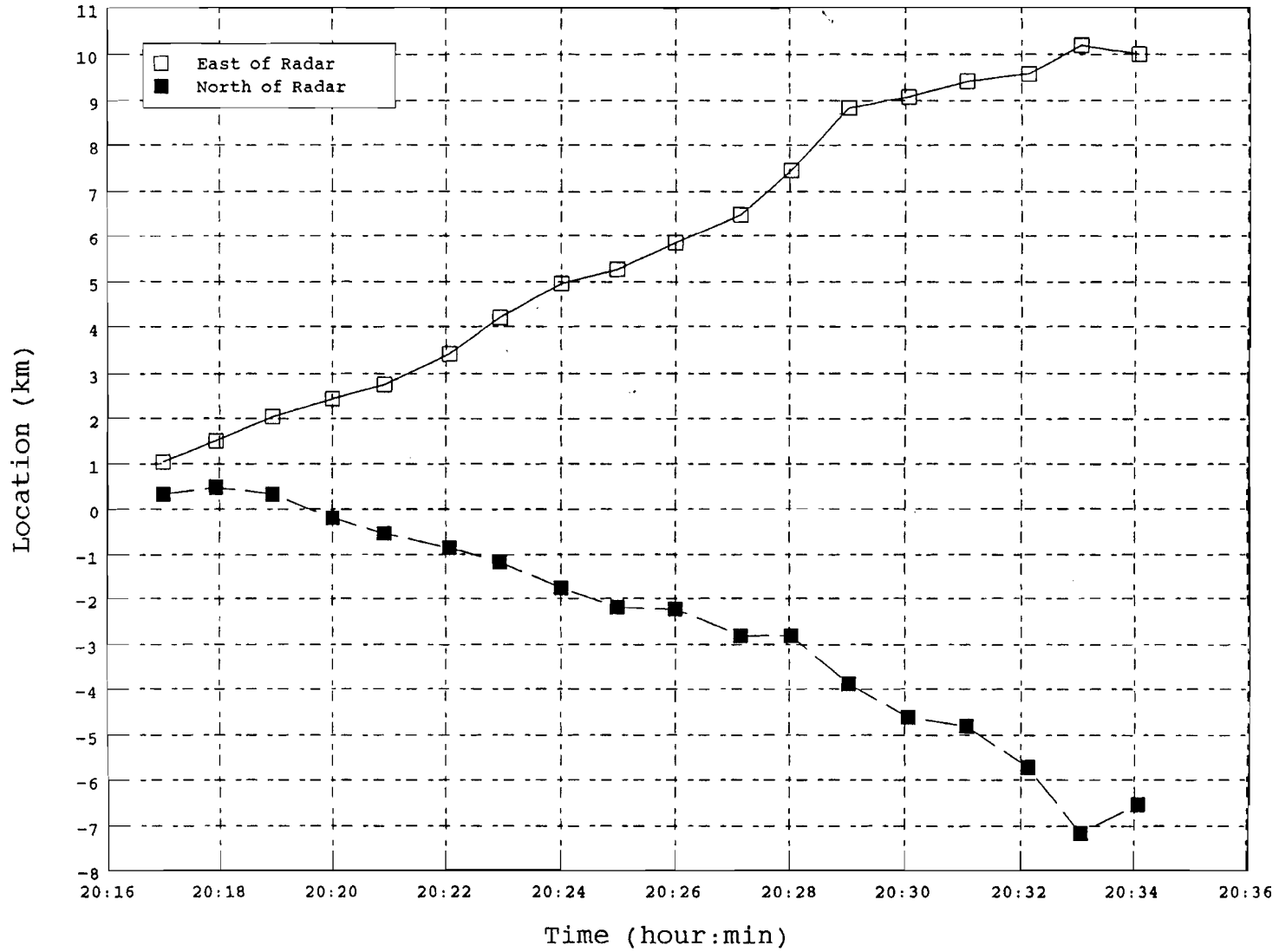

Figure 6. Motion of a strong Kansas City microburst as taken from the ITWS shear regions algorithm.

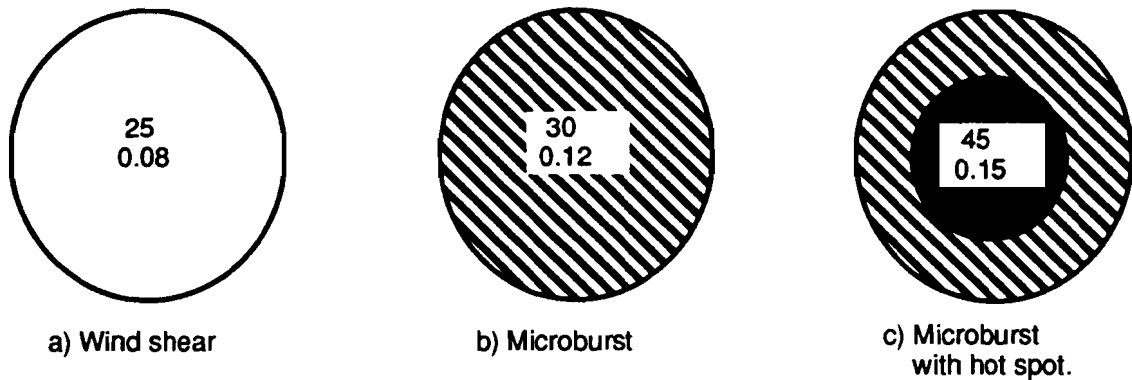

Figure 7. Proposed ITWS microburst shape displays (loss value on top and F factor on bottom of label).

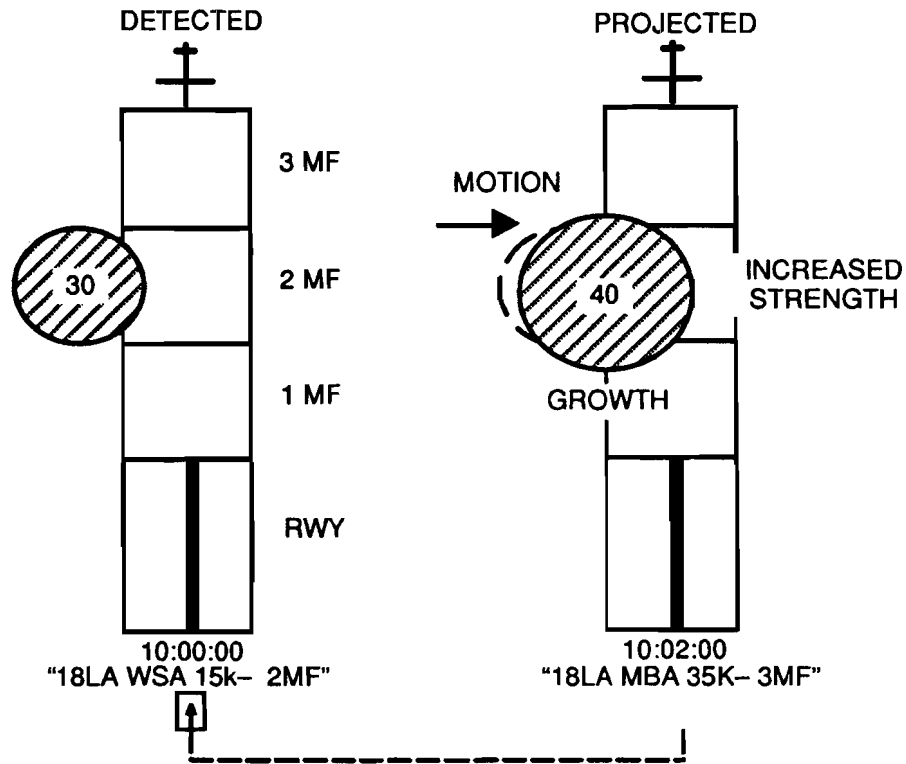

Figure 8. Proposed ITWS microburst trend message display.

bursts are likely and 2) to provide an additional margin of safety for pilots in avoiding microburst wind shear hazards. The product is envisioned for use by traffic managers, supervisors, and pilots (via datalink). Our objective is to accurately predict the onset of microburst wind shear five or more minutes in advance. Given the predicted location and timing of an incipient microburst, supervisors/traffic managers may plan to land flights already lined up on fi-

nal approach and vector other flights to an unimpacted runway, as illustrated in Figure 9. Without predictions, pilots probably would execute a missed approach when a TDWR microburst alert is issued as they are approaching the runway. Any pilots who “go around” must return to the approach sequence to be handled again by controllers, thus increasing workload. Additionally, some pilots may proceed through the microburst if there is a short time interval between the start of the microburst and the plane’s encounter.

Several members of the TDWR User’s group (Lincoln Laboratory, 13–15 November 1991) stressed that they must have an extremely high level of confidence in a microburst prediction product for it to be useful. They suggested that near–perfect accuracy with essentially a very low rate of false alarms was needed when predicting microbursts or the system would be more of a hindrance than a help. Specifically, they felt that microburst onset timing should be accurate to within one minute, and location accurate to within 1 nm for every predicted microburst. These recommendations were incorporated into the ITWS Functional Requirement for Microburst Prediction and also have shaped the algorithm development effort over this first year.

The approach chosen in developing the microburst prediction algorithm emphasizes fundamental physical principles of thunderstorm evolution and downdraft development, incorporating heuristic and/or statistical methods as needed for refinement. Doppler radar data

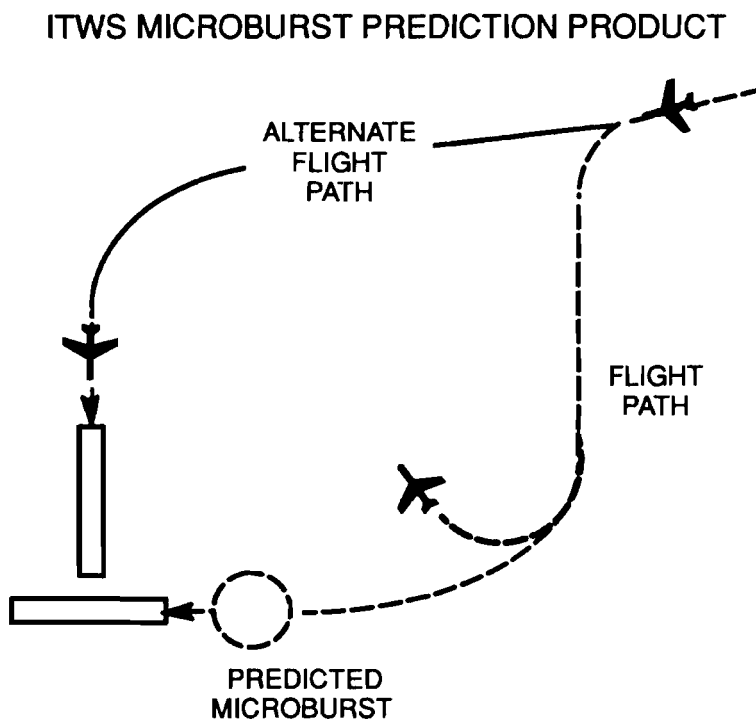

Figure 9. Illustration of improved safety and planning possible with microburst prediction product. A controller originally planning to vector a pilot onto the dashed flight path might choose an alternate path (solid) if a microburst were predicted to impact the final approach within the next five minutes.

is used to identify thunderstorms and probable regions of downdraft and is combined with measures of the ambient temperature structure (height of the freezing level, lapse rate in the lower atmosphere) to predict the outflow strength that will eventually be produced. A theoretical basis for this was worked out by Wolfson [3].

The radar data source for the ITWS microburst prediction algorithm will be primarily the TDWR, with a 2.5 min. volume update rate in the airport sector whenever hazardous weather is present, although the utility of combining this with ASR-9 six-level reflectivity data will be investigated because of its 30 sec. update rate and integrated coverage. NEXRAD data does not update frequently enough to be deemed useful for this algorithm. The temperature data source will be a combination of meteorological data collection and reporting system (MDCRS) temperature data obtained through ARINC's ACARS data link from commercial aircraft of opportunity and surface temperature data from the airport ASOS station. Efforts to increase airline participation in the MDCRS program and increase the sampling rate of the aircraft as they ascend and descend in the terminal area are already underway at the FAA and at ARINC.

2.2.2. FY92 Accomplishments

Effort during the 1992 fiscal year fell into three major areas: 1) research on existing storm identification algorithms and image processing systems to determine the most fruitful algorithmic approach, 2) meteorological research on thunderstorms to determine the reliable detectable signals of microburst development, and 3) evaluation of MDCRS as a source for temperature data and development of a technique to combine measurements to create a continuous temperature profile.

Algorithmic Approach

The initial development of the microburst prediction product involved the investigation of existing storm identification algorithms. NEXRAD and TDWR algorithms and techniques used "in-house" by the Air Force Geophysics Laboratory (AFGL), the National Center for Atmospheric Research (NCAR), and the National Severe Storms Laboratory (NSSL) were investigated. In every case, the algorithms began either by segmenting or contouring the data (3-D polar or Cartesian format) in two dimensions and identifying features (storms or shear regions) separately in the reflectivity and Doppler velocity data. Three-dimensional storms or hazard regions were composed of overlapping features which did not always give results that agreed with subjective analysis. Also investigated were some of the techniques used by the Meteorological Center of Quebec developed at McGill University for operational processing of the Canadian volume-scanning weather radars. The use of 2-D representations of the 3-D dataset (e.g., VIL, echo tops, etc.) appeared particularly useful.

In March, a cooperative effort began with the Machine Intelligence Technology group (Group 21) to look at development of a knowledge-based microburst prediction scheme. This novel approach uses image processing and data fusion techniques to produce an "interest" image that reveals (in this case) developing downdrafts [4]. By April, a preliminary analysis was performed on one Orlando case that indicated the system had real promise, and by May it was decided to build the original algorithm in the Group 21 "Sketch" image processing system.

Meteorological Research

A triple-Doppler radar network was deployed in Orlando in 1991 and 1992. The network consisted of the TDWR testbed radar and the MIT and University of North Dakota (UND) Enterprise C-band Doppler radars sited in an equilateral triangular formation around MCO. A very accurate hybrid triple-Doppler analysis technique was developed, implemented, and tested for use on these datasets. Several excellent cases were recorded that included complete storm life cycles, and one was analyzed in detail (August 9, 1991) and discussed at the March program review. The results indicated that it was less important to isolate reflectivity “cores” as objects (e.g., defined as a region bounded by a constant reflectivity threshold) than it was to identify regions of common growth/decay characteristics (e.g., regions of increasing/decreasing water content, regions of descending center of mass, etc.). For example, one case was found in which two disconnected regions of 45 dBZ reflectivity contributed to the same downdraft and microburst, and in another case two regions of 45 dBZ were joined but one was growing and the other was decaying. The Sketch image processing system is perfectly suited to identifying the regions of common time-dependent characteristics. The triple-Doppler case also was useful for verifying the downdraft and outflow strength prediction equation.

Meteorological research also was required to determine exactly which radar-detectable storm features were truly significant for prediction of the downdraft and subsequent outflow development. An analysis and display system was developed over the fiscal year that would allow an analyst to “rope off” a region of the gridded radar field and to automatically compute average values of, e.g., VIL, center of mass, etc., as a function of time for the storm (Figure 10). A set of 17 storm cells on five different days from Denver, Kansas City, and Orlando were chosen as the microburst prediction test cases. We found that increases or peaks in the VIL field and a descending center of mass were the most reliable predictors of microburst onset (Figure 11). This was true for both the very “wet” microbursts found in Orlando and Kansas City and the “dry” microbursts found in Denver. We also found that storm

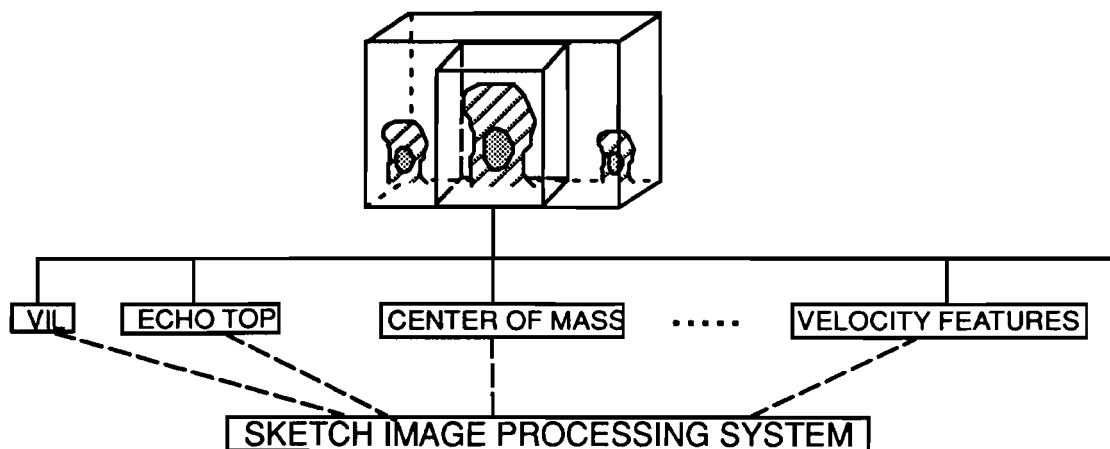

Figure 10. Schematic showing the microburst prediction analysis and display system. An analyst would select the inner boxed region to contain one storm, and the system would then compute the selected properties. These ultimately will be combined in the Sketch image processing system to make up the microburst prediction algorithm.

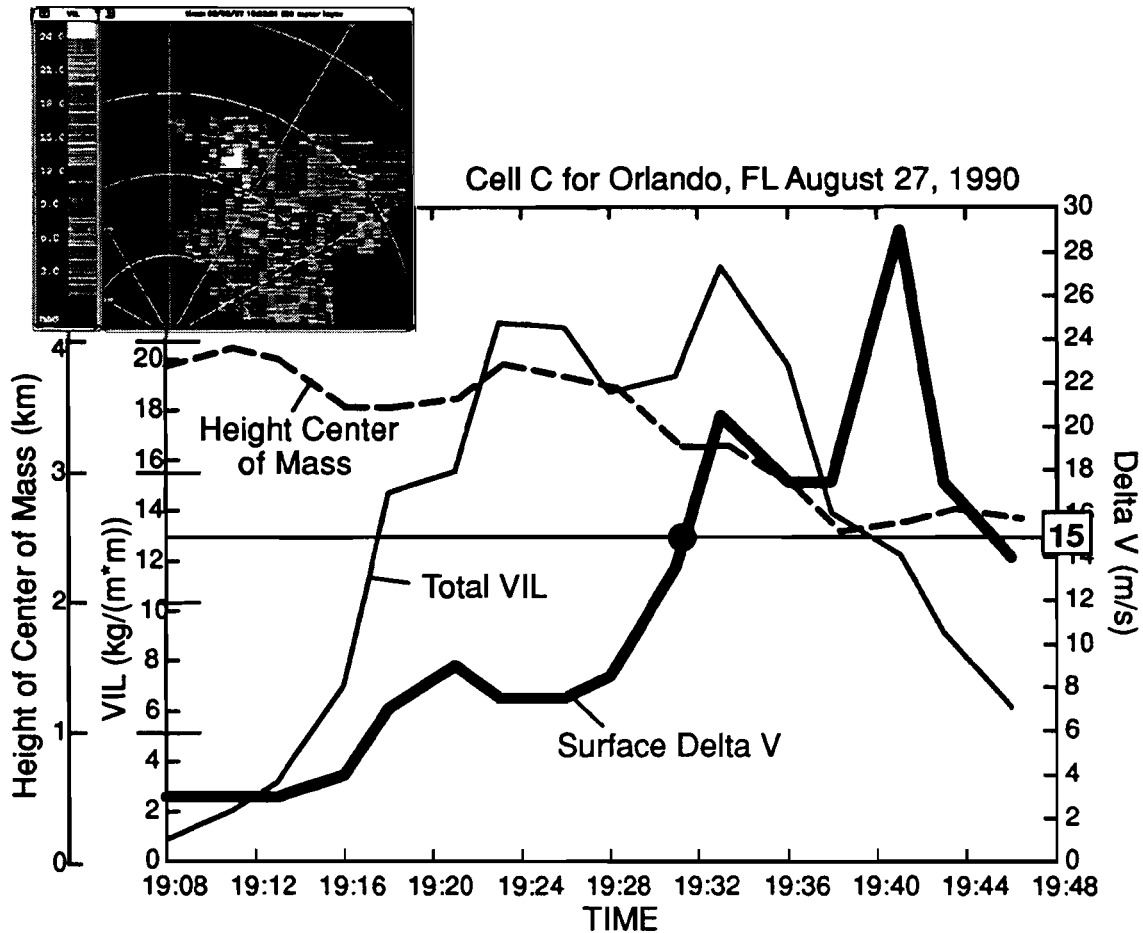

Figure 11. Graph showing VIL and the height of the center of mass relative to the surface differential velocity (ΔV) computed by the microburst prediction analysis system for one of the microbursts on August 27, 1990 in Orlando. The cell "roped" by the analyst is shown in the upper left corner. Notice that the VIL peaks both before the microburst onset (solid black circle) and before the uptrend that occurs eight minutes afterward.

top divergence, when correctly computed on constant altitude surfaces, also was a significant predictor of "wet" microbursts. The initial feature detectors for the Sketch system will identify these signals in the volume scan data.

Temperature Profiles

By the beginning of the fiscal year, ARINC had successfully implemented a prototype query-based MDCRS data access system according to Lincoln specification on their development system. MDCRS data were collected hourly throughout the year (every 15 min. during the terminal local analysis and prediction system (T-LAPS) demonstration) via dial-up modem and archived at Lincoln Laboratory. Arrangements were made with United Airlines to activate their special ascent/descent data collection (measurements made every 2000 feet) in the Boston area during a violent nor'easter on Halloween 1991 and on several other days during October and November. During this time, arrangements were made for special balloon soundings to be launched from a site nearby to serve as "truth." Using these data plus several test datasets from Orlando when balloon soundings also were available, a simple linear interpolation scheme was implemented for deriving temperature and wind profiles. It

weights data collected over the most recent three hours within 100 km of the airport, although these parameters are adjustable. Preliminary comparisons between interpolated MDCRS profiles and balloon soundings show excellent agreement with data from a single aircraft if the rapid (every 2000 ft.) reporting scheme on ascent and descent is implemented. If the usual reporting scheme is implemented (one measurement every six to seven min.), then data from several aircraft are required to build a profile that compares favorably with balloon soundings. This interpolation code formed the basis for the real-time ACARS data collection and approach/departure winds product demonstrated in Orlando during July and August. The temperature profile is needed for the microburst prediction product, and this code plus refinements to utilize the ASOS datapoint at the surface will be part of the 1993 Orlando demonstration.

2.2.3. FY93 Plans and Issues

Plans for the 1993 fiscal year include completion of the microburst prediction algorithm by May, including development and testing of several feature detectors indicating the early, middle, and late stages of microburst formation. A complete end-to-end system will be available by February. From then on, a suite of test cases will be run each night, analyzed the next day, and system modifications will be made to achieve a highly reliable system. Real-time testing and evaluation is scheduled to take place in Orlando during July and August. If the preliminary testing appears promising and if the Aviation Weather Development Program (AWDP) product review committee and the FAA give permission, perhaps the microburst prediction algorithm can be shown to Orlando supervisors and traffic management coordinators (TMC) this summer. The goal of transferring the microburst prediction algorithm output directly to pilots via datalink will almost certainly have to wait until the 1994 ITWS real-time demonstrations.

Several procedural and operational issues arise with the use of a safety-related planning product like the microburst prediction algorithm and will have to be addressed. For example, what needs to be determined are just how the TMC and supervisors operationally uses this planning product and what the procedures will be if a pilot receives this information directly. Additionally, efforts must continue to ensure the availability of MDCRS data routinely at ITWS airports, preferably with the special ascent/descent reporting scheme.

2.3. VERTICAL WIND SHEAR

2.3.1. Background

This effort originally began in response to the need to detect nocturnal low-level jets to mitigate false alarms generated by the TDWR gust front algorithm. However, abrupt vertical shears in the horizontal wind field are potentially hazardous to aircraft and are therefore of interest to pilots in the terminal airspace. For this reason, the focus of the work was expanded to include detection of all vertical wind shears in the terminal environment. This algorithm will generate the Vertical Wind Shear (VWS) Product for the ITWS.

2.3.2. FY92 Accomplishments

The VWS algorithm operates on a vertical wind profile (VWP), which is an estimate of the horizontal wind speed and direction at various altitudes. One source of VWP is the Veloc-

ity–Azimuth Display (VAD) algorithm. During this past year, numerous modifications were made to the Lincoln implementation of the Next Generation Weather Radar (NEXRAD) VAD algorithm. A parameter program was built to read processing variables and threshold values, thus eliminating the need for user interaction. The number of VAD analyses performed was increased substantially to enhance the vertical resolution of the resultant wind profiles. The extra VAD processing slowed the algorithm considerably. As a result, many modifications were implemented to improve the algorithm’s efficiency. Real–time code also was developed for the VAD algorithm.

The VAD algorithm operated in real time at the FL–2C testbed in Orlando from late June through September 1992. Early in the period, the clear–air return was not strong, and as a result, the maximum altitude of the VWPs was limited to 2 km above ground level (AGL). After monitoring the performance of the VAD in real time, some thresholds were altered. A comparison of the vertical wind profiles produced by the VAD, rawinsonde data, and the Meteorological Data Collection and Reporting System (MDCRS) showed reasonable agreement. In addition, a literature search was conducted to characterize the low–level jet phenomena that are common to the Central Plains states.

The operational requirements of the VWS product were defined. The detection of VWS will be made at intervals of 100 feet below 1500 feet AGL and at intervals of 250 feet from 1500 feet to 10,000 feet AGL. Vertical wind shear is most hazardous to aircraft below 1500 feet, but the peak shears associated with a low–level jet are sometimes found as high as 10,000 feet. These detection resolutions are needed to provide adequate protection to aircraft while sufficiently characterizing the hazard. Two methods of computing VWS were implemented. One method computes the magnitude of the wind vector difference between two altitudes, reported as a loss, and the other method computes the headwind and crosswind shear an aircraft would encounter between two altitudes given that the aircraft heading is known. The methods used to compute VWS are preliminary; enhancements and development are ongoing.

The NEXRAD VAD, a high–resolution version of the NEXRAD VAD developed at Lincoln, and a high–resolution VAD algorithm developed at NSSL were compared. VWPs were generated from the Lincoln and NSSL VADs for eight data cases and the results were compared. Balloon sounding data were used as ground truth in five of the cases. NEXRAD VWPs were not used in the comparison because of the unavailability of data and poor vertical resolution of the profiles. The purpose of the study was to determine what differences existed between the profiles, what were the reasons for the differences, and what would the cost be to use either algorithm within the ITWS program.

2.3.3. FY93 Plans and Issues

The development of the VWS algorithm will continue. Specifically, the implementation of real–time and archival capabilities will be completed. In the near future, a study will be performed to determine operationally significant thresholds of VWS. One issue that needs to be addressed is the specification of the type of warnings required by the various users.

Techniques for improving the VAD wind profiles with the addition of other sources of wind information will be explored. To support this effort, an analysis will be performed whereby several wind profile data sources are collected and merged. By merging the data

sources, it is assumed more accurate wind profiles will be produced and will agree more closely with rawinsonde data than VAD wind data alone.

VAD wind profile data and VWS estimates will be generated off line from the data collected during the summer 1993 ITWS demonstration in Orlando.

2.4. GUST FRONT/WIND SHIFT

Wind shifts at an airport have operational significance since they can dictate a change of the runway configuration. The detection and location of a wind shift boundary also can be an important input to other ITWS algorithms. Strong wind shifts are frequently associated with gust fronts, the outflows from convective storms. When these events are near the runways, they can be a hazard to aviation, precipitating an alert indicating a wind shear with headwind gain. All of the wind shear detection systems (TDWR, LLWAS, ASR-9/WSP) have algorithms for detecting these wind shear events. The radar systems have algorithms for detecting and tracking wind shift boundaries. The current TDWR algorithm has a rather weak detection performance and the ASR-9/WSP algorithm is very effective but is implemented only in the region of radius 30 km from the airport. This latter algorithm is called the machine intelligent gust front algorithm (MIGFA) and is based on a very powerful detection and tracking technology that is being investigated as a basis for an improved TDWR algorithm.

There has been no effort devoted to the development of ITWS gust front and wind shift products this year. The detection of hazardous wind shear from gust fronts by the various wind shear detection systems is very satisfactory. Up to this time, no evidence has been found to indicate that there would be significant value in an additional ITWS gust front algorithm. Development efforts for a TDWR MIGFA indicate that there is significant room for improvement in the detection and tracking of wind shift boundaries. There is a natural extension of these techniques to the multiple radar information of the ITWS domain, and development of an ITWS MIGFA will begin as soon as the development of the TDWR MIGFA is complete.

2.5. TDWR GRIDDED WINDS AND REFLECTIVITY

The gridded winds and reflectivity products are representations of the TDWR base data at the analysis times and at the grid point positions of an associated gridded analysis system. The base data from the TDWR consist of the reflectivity and the radial components of the wind velocity at each range gate. The data rate for these data is approximately 1 kilobyte/second. The aviation gridded forecast system (AGFS) and other gridded analysis systems will use these data at their grid points and at their analysis times. Typically, the required data set is considerably smaller than the full set of base data. In addition, there are occasional erroneous values in the base data that are corrected during the gridding process.

The product development in 1992 was directed towards the development of gridded radar data for the T-LAPS winds analysis. This analysis uses data on a 2 km horizontal grid and at various vertical levels. The technique that was developed is an efficient median filter which is applied to all radar range gates that lie in the 1 km region about each grid point (0.5 km radius of the grid point). This filter is applied at the (x,y) location of each grid point on each tilt of the radar data. A missing data flag is set if too many data are missing near a

particular grid position (percent good data parameter). Vertical linear interpolation is used to obtain values for each of the vertical levels.

This product performed well as a basis for the T-LAPS winds analysis. Occasionally, data quality was a problem. When a percent good data parameter of 50 percent was used, there were significant problems with second-trip breakthrough. It was discovered that this problem is related to the fact that the second-trip editor attempts to remove approximately 50 percent of the data that are contaminated by second trip echoes. Many of these problems were solved by using a percent good data parameter of 80 percent. There is still a problem with occasional isolated extreme radial velocity values. Another area of concern is velocity aliasing of the NEXRAD data. TDWR has a velocity dealiasing algorithm which is applied before its base data are received. In the NEXRAD system, the base data received over the FAA base data port are not dealiased. There have been no significant problems due to this, which may be due to chance or to benign Florida weather.

Overall, the performance of the gridded winds product as a preprocessor for T-LAPS is very good. The performance in this arena is indicative of what would be required of a gridded analysis product for a variety of applications. In the coming year, some modest changes will be made to this product. A velocity dealiasing algorithm will be added to the NEXRAD data processing. More attention will be given to data quality issues, and the design of the vertical interpolation algorithm will be reviewed.

2.6. ITWS TERMINAL WINDS

2.6.1. Background

The ITWS terminal winds algorithm is designed to provide gridded three-dimensional winds for a variety of automated systems (e.g., CTAS, wake vortex advisory systems) and to provide wind information for other ITWS algorithms (e.g., runway winds algorithm, ceiling and visibility algorithms). The initial approach to product development was to develop an extension of the local analysis and prediction system (LAPS) that was developed by NOAA/Forecast System Laboratory (FSL) over the past eight years. The LAPS winds analysis algorithm was developed to compute a three-dimensional gridded wind field on a grid with a horizontal spacing of 10 km and an update rate of 60 minutes (10 km / 60 min.). LAPS estimates the wind field by taking in a background wind field, or first guess, from the mesoscale analysis and prediction system (MAPS), a national model from FSL, and adjusting it by incorporating recent local measurements of the winds. This extension is called the terminal local analysis and prediction system (T-LAPS) and is being developed in cooperation with FSL.

The requirements for the ITWS terminal winds product have not been determined. It was decided that the data do not support an analysis that exceeds the resolution of the TDWR (2 km horizontal grid and a five-minute update, with finer resolution in space and time at the airport surface) and that some products will require this resolution. Until better information is available, an update of 2 km / 5 min. is the T-LAPS goal. In the absence of accuracy requirements, the accuracy of the wind field product will be evaluated statistically.

There are several ways in which the T-LAPS analysis differs from the LAPS winds analysis. First of all, there is the difference in analysis scale. The consequence of this is a much coarser background scale relative to the analysis scale:

- MAPS (60 km / 180 min.) > LAPS (10 km / 60 min.)
- MAPS (60 km / 180 min.) >> T-LAPS (2 km / 5 min.)

Secondly, the impact of the data sources are somewhat different. Due to the temporal and spatial scales of LAPS, Doppler radar is not a dominant data source. TDWR is the dominant data source in the terminal area and should dominate T-LAPS. Traditional LAPS has no capability to use data from more than one radar, while the ITWS domain expects to have both TDWR and NEXRAD base data, and some TRACONS will have multiple TDWRs and NEXRADs. On the other hand, PROFILER data are extremely important to LAPS and are not directly available to the ITWS. It is expected that frequent ACARS reports from ascending and descending aircraft will serve this purpose for T-LAPS. Due to communications delays, ACARS reports will not be as timely as the radar data. For this year, the two areas of emphasis are to provide T-LAPS with a multiple radar capability and to deal with the scales-of-analysis issues.

2.6.2. FY92 Accomplishments

The multiple radar approach that was developed is called "multiple single-Doppler radar analysis." It is an extension of the single-Doppler analysis that is used in LAPS. It differs from dual-Doppler analysis in that it does not suffer from baseline instabilities and it easily accommodates irregular data availability. Time and hardware constraints in preparing for the summer demonstration required using a rather naive initial implementation. Substantial improvements will be made in this area.

A solution to the scales-of-analysis issue was developed. This approach is called the cascade of scales analysis. This approach is shown in Figure 12 and is described by

MAPS (60 km / 180 min.)
> T-LAPS10 (10 km / 30 min.)
> T-LAPS2 (2 km / 5 min.)

where T-LAPS10 combines MAPS, ACARS, automated surface observing system/automated weather observing system (ASOS/AWOS), and a little radar data, very much in the spirit of LAPS, and T-LAPS2 combines T-LAPS10, LLWAS, and radar data in a radar-dominated analysis.

A major accomplishment in 1992 was a successful field demonstration of T-LAPS at MCO. This real-time software system required extensive development efforts in data acquisition, process control, and displays. The experiment ran from 17 August to 25 September, primarily from 10:00 am to 7:00 pm local time. This was the first time that base data from a NEXRAD were accessed for real-time use outside of the NWS and the first time that TDWR and NEXRAD data were combined in a real-time analysis. The regions for which the winds were computed is shown in Figure 13. The regions for the MAPS data, 10 Km, and 2 Km analyses are shown as well as the locations of the TDWR and NEXRAD radars and support radars from MIT and UND.

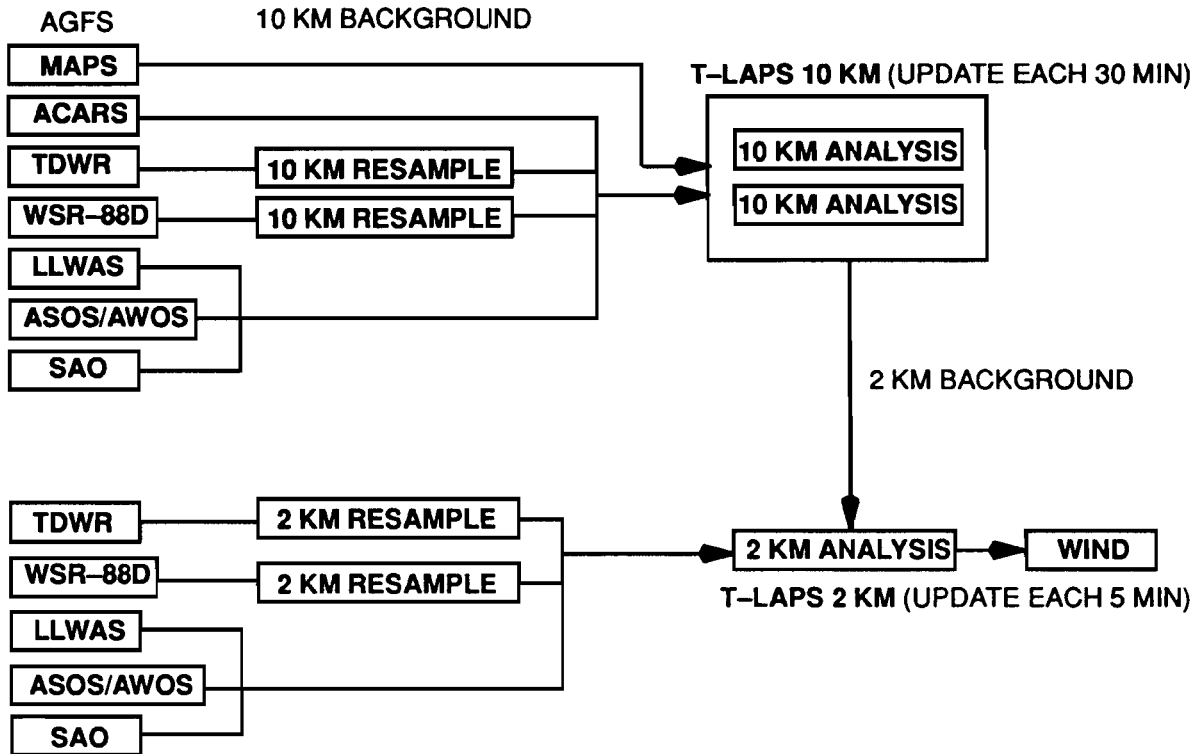

Figure 12. T-LAPS cascade of scales.

Two pictures of the displayed wind field are shown in Figures 14 and 15. Both show the winds at the surface in the afternoon/evening of 20 August. The winds are shown as scaled arrows (top right corner shows a 5 m/s arrow), and the colored background is the reflectivity field from the prototype TDWR radar. The coastline and a few lakes are shown in white outline, and the runways at MCO are shown in red in the center. The grid resolution has been reduced to 4 km to reduce visual clutter. The first picture shows the wind at 21:30:00. There is a gust front generated from a storm off to the southeast of the display. A reflectivity thin line is clearly visible and the convergence can be seen in the wind field. This gust front collides later in the day with some storm activity near MCO, which in turn spawns new convective activity. This later storm and associated wind field are shown in Figure 15.

Evaluation software was developed to score the accuracy of the ITWS winds against independent ACARS reports and special NASA aircraft data, soundings, and dual Doppler. Preliminary evaluation results, shown in figure 16, are encouraging.

This experiment demonstrated that the system was relatively robust and provided good estimates of the winds under most conditions. However, there are circumstances when the algorithm logic does not perform as well as required. Also, it was learned that data acquisition is a very significant task and that data quality checking needs to be improved.

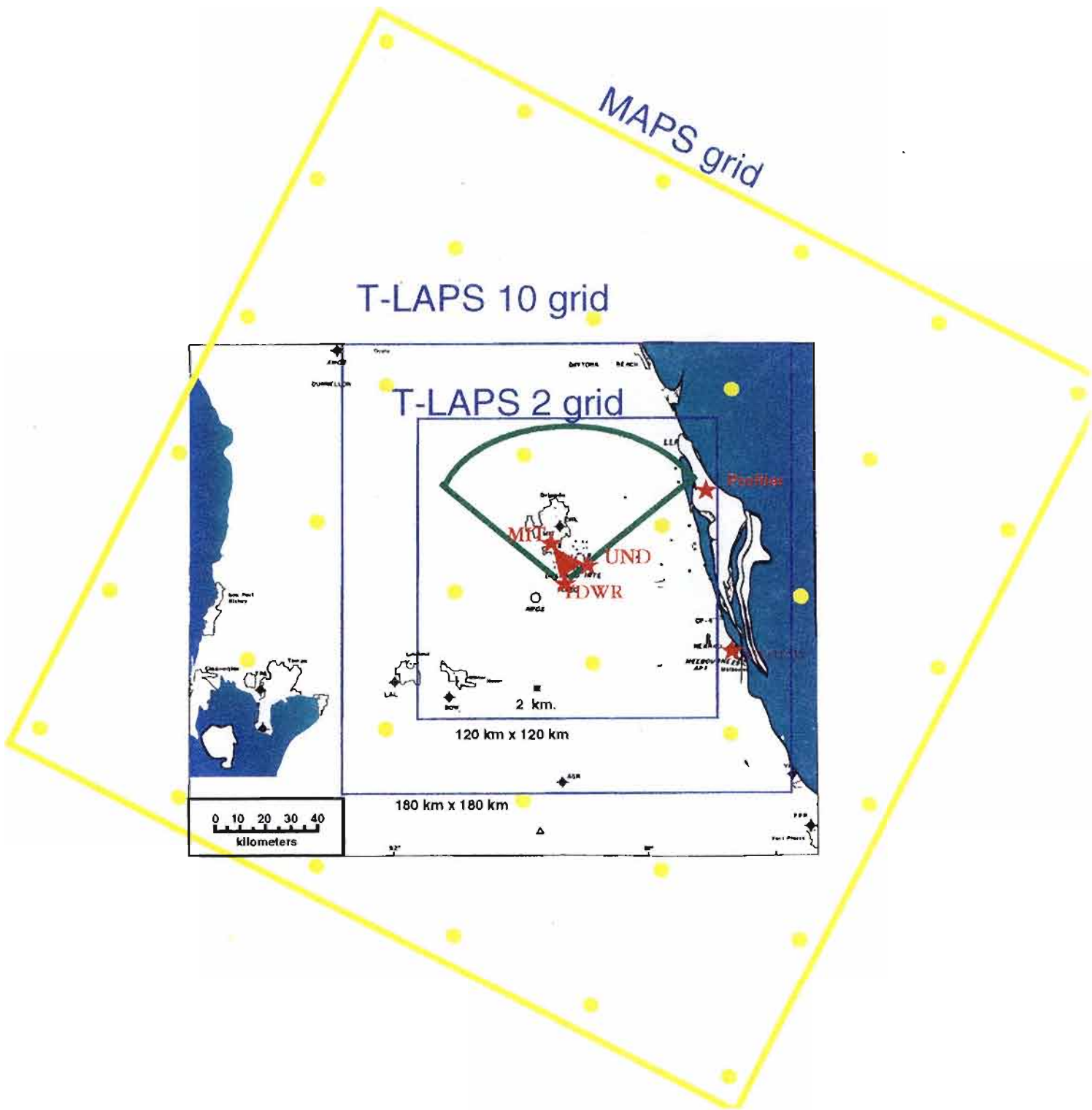

Figure 13. The boundaries of the T-LAPS analysis regions near Orlando International Airport.

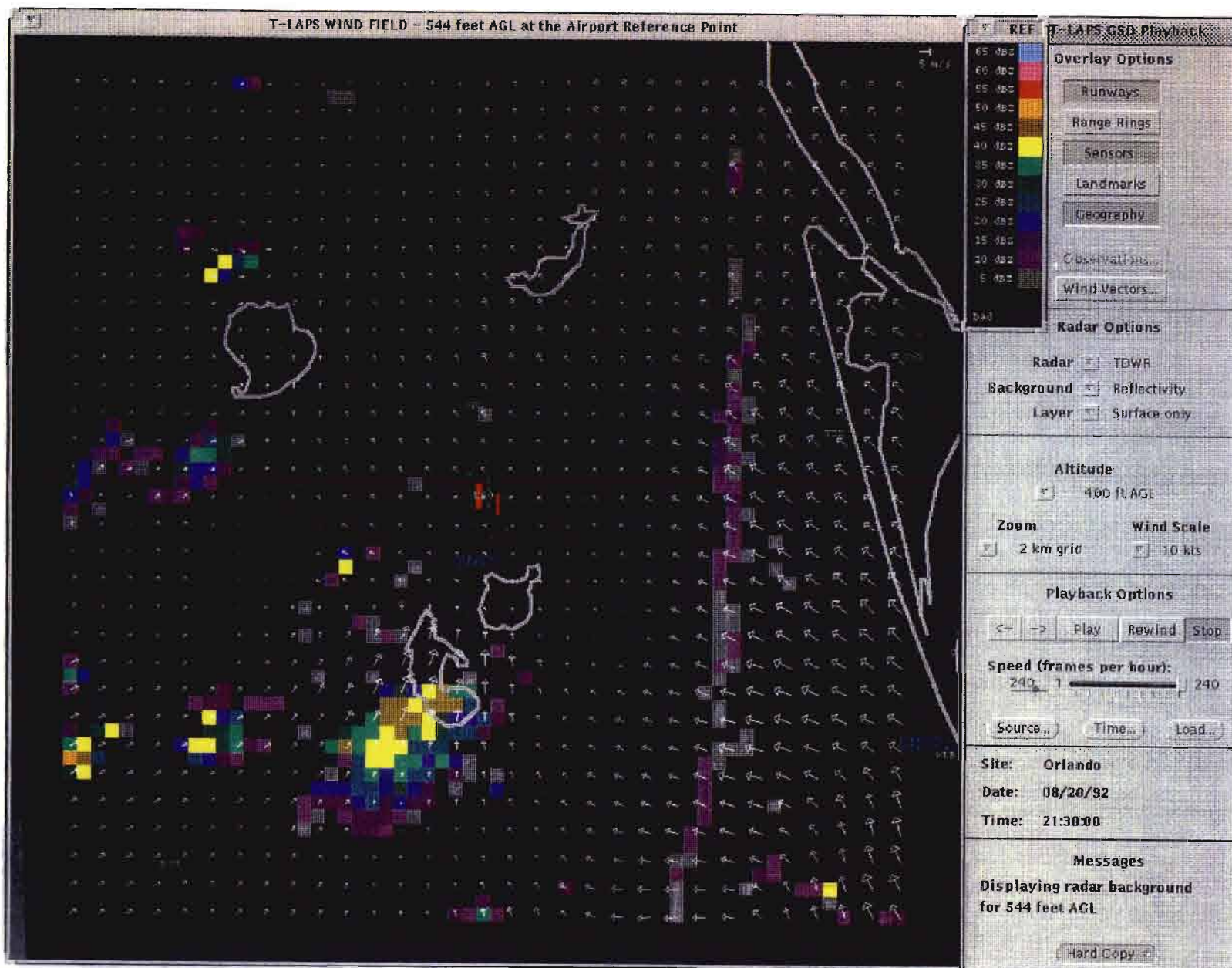

Figure 14. The T-LAPS analyzed wind field at 21:30 GMT on 20 August 1992. The grey patches indicate radar reflectivity. Note the wind field convergence and reflectivity thin line on the right side of the display.

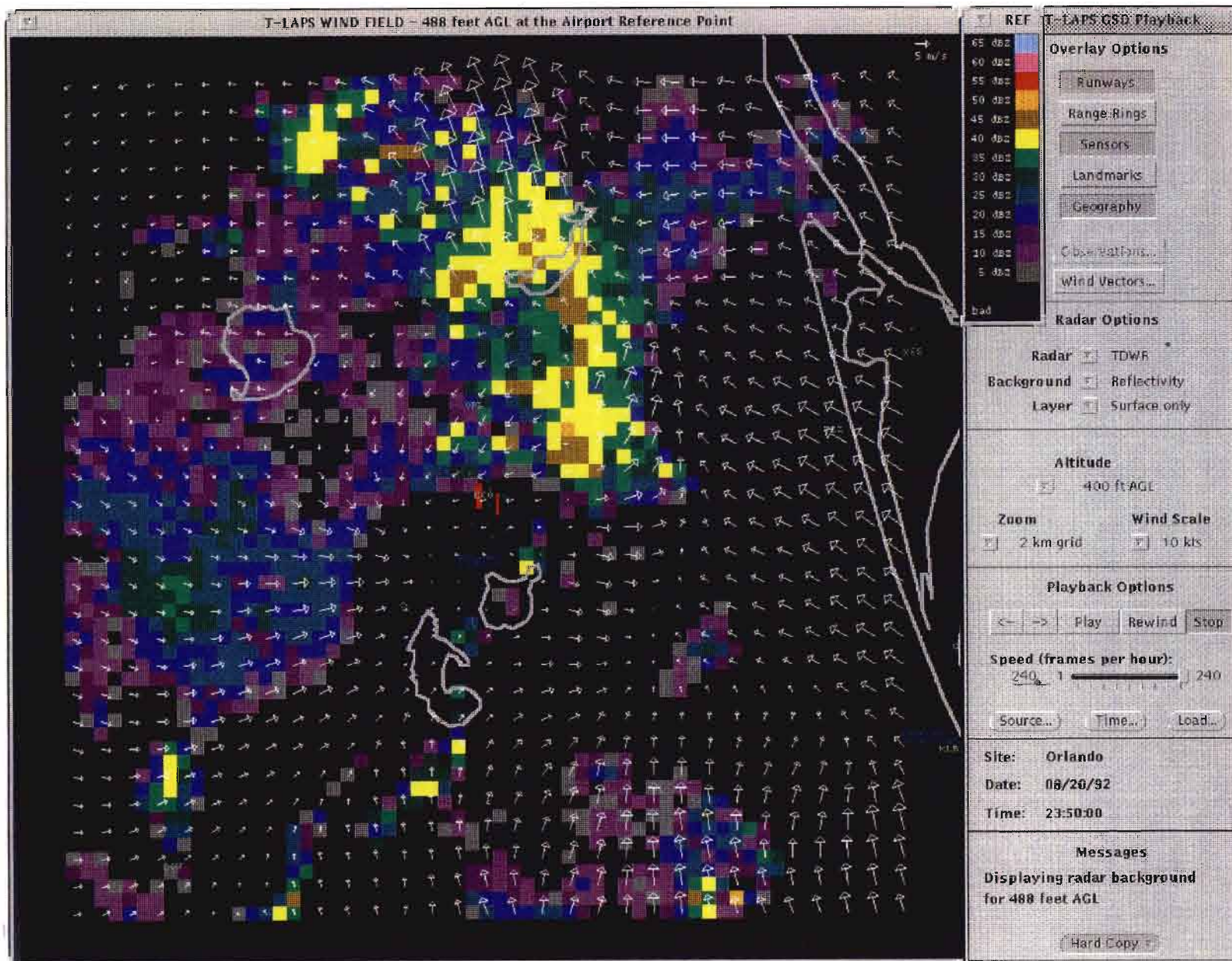

Figure 15. The T-LAPS analyzed wind field at 23:50 GMT on 20 August 1992. Note the strong storm at the top center of the display.

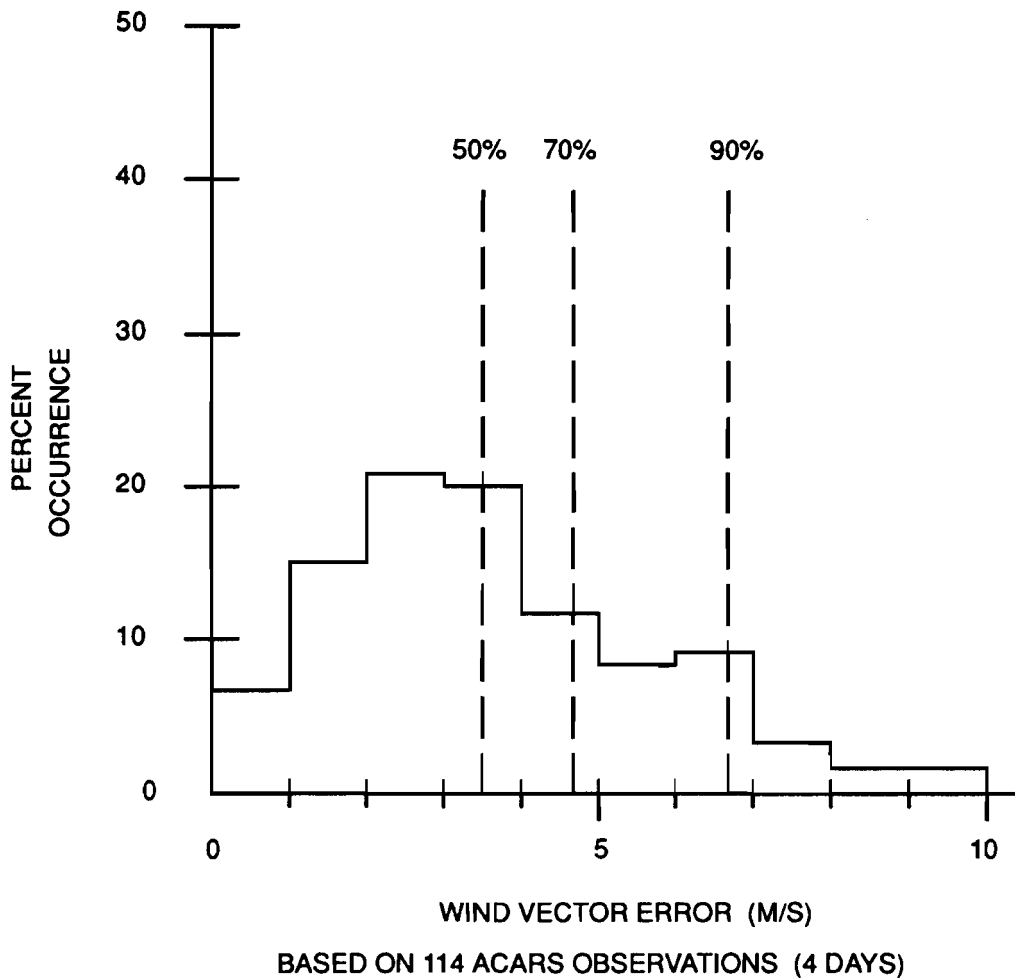

Figure 16. Preliminary performance evaluation.

2.6.3. FY93 Plans and Issues

Plans for 1993 include work on the following tasks:

1. Evaluations:
 - In-depth evaluation of the results from the 1992 experiment
 - Evaluation of additional methods developed at NCAR, UK Meteorology Office, and the Center for Analysis and Prediction of Storms (CAPS)
2. Algorithm upgrades:
 - Develop refinements to T-LAPS
 - Incorporate the LAPS surface analysis
 - Develop runway winds algorithm
 - Develop wind shift algorithm

3. Real-time system upgrades:
 - Refine control software
 - Refine the display software
4. Define the TATCA interface for the terminal winds products.

In the summer of 1993 the T-LAPS system will undergo continued testing at the MCO testbed and at Dallas-Ft. Worth (DFW). The primary development effort will be concentrated on the MCO testbed due to the greater availability of data at that site. Two separate upgrades to the ITWS gridded winds product will be run in real time and evaluated on the data collected at MCO as well as the T-LAPS surface analysis. A subset of both the gridded winds and surface analysis outputs will be available operationally in the National Weather Service's Melbourne, FL office. The MCO data also will be utilized for the development of the runway winds product. The primary purpose for the DFW testbed is for the development and testing of the ITWS gridded winds interface to the TATCA system.

2.7. STORM MOTION/SNOW-STORM MOTION

2.7.1. Background

The ITWS Storm Motion algorithm was proposed to provide estimates of short-term local storm motion (speed and direction). This is distinguished from a "tracking" algorithm, which might function by displaying long-term tracks (historical locations) of specific storm cells. Clearly, the two approaches can work in support of each other; the algorithm proposed here has, as its aim, the former functionality. The goal is to provide one algorithm that performs equally well in estimating the motion of line structures and isolated cells. The notion of a separate "snow storm" (snow band) algorithm has been introduced to make distinct those performance issues that can be expected as resulting from very different input data profiles (weather reflectivities). The same algorithm (development effort) supports both functionalities, as described below.

A motion/tracking functionality can be considered fundamental and almost indispensable in a system that will service both ATC personnel and other product-generation algorithm users in a "quick-look" capacity. The above products would prove useful to a wide range of ATC users, from support of the terminal planning needs of ATC managers to larger-scale regional needs in air-traffic management. Inclusion in uplink to pilots could also prove useful. In general, any "user" with interest in weather reflectivity should find an accompanying nowcast of motion useful.

Compensation for, or the anticipation of, advective motion is a recurrent theme across a variety of algorithms. Our approach to the present design is based on the notion that one common processing algorithm (design effort) could serve multiple needs. At least initially, focus has been on creating a storm motion algorithm. But winter snow band tracking and VIL data tracking in support of the microburst prediction algorithm are extensions that are considered entirely feasible. There are at least two mechanisms for achieving this multi-function objective. First, one motion algorithm internal to the ITWS system could act as a real-time server for multiple users (i.e., storm motion, snow band motion, microburst prediction, etc.). Alternatively, the motion detection/estimation algorithm should be sufficiently modularized and

the required pieces duplicated, as needed, in each respective user algorithm. The work will be described in the spirit of the first implementation. How the final implementation occurs is dependent upon the ITWS platform capabilities. The method of implementation is not a critical issue. However, rather than propose one internal ITWS motion algorithm, it is easier to speak of motion detection for storms, snow bands, etc., as individual algorithms because these are the end-user products for which expected performance can be identified.

2.7.2. FY92 Accomplishments

A correlation tracking algorithm was developed previously as a prototype design for TDWR. This algorithm has operated successfully in the Lincoln TDWR testbed for over three years now, leading to the current proposal that a similar approach could be successful in meeting the above goals. An initial storm motion product also can be based on the TDWR prototype: a display overlay consisting of strategically placed arrows showing direction and speed of motion. Initial FY92 efforts were directed at extracting and improving upon the correlation methods explored in the TDWR prototype. These efforts involve a substantial recoding of previously designed software and include research directed at making a more robust (with respect to input variety and variability) correlation processor. The algorithm coding effort will continue through FY93. The direction of research is briefly indicated in Figure 17(a) which illustrates the open-loop approach to correlation analysis employed in the TDWR prototype. This method relies heavily on "clean-up" procedures to filter and eliminate outliers due to source-data variability. Part (b) indicates the major elements being explored to create a new constrained correlation processor. Elements shown in grey and pathways with broken lines are not complete as of the end of FY92. The approach of part (b) introduces feedback in the analysis and also includes a mechanism whereby image structure is taken into account in determining a "quality factor" for local correlation measurements ("local analysis" and "prior density" segments). As a result of these new components, it is expected that the correlation analysis will require much less in the way of ad hoc clean-up procedures, which should provide improved resolution with respect to local motion estimation.

2.7.3. FY93 Plans and Issues

Goals call for 1993 deployment of the ITWS-designed correlation algorithm. However, to support a spring 1993 IOC capability, the existing TDWR prototype was modified to provide a fallback capability for initial spring deployment of a storm motion product. Modifications to the existing TDWR prototype are complete in that they provide the functional components illustrated without shading in Figure 17(b). Inasmuch as a successful correlation-based tracking algorithm was demonstrated previously, using both TDWR and ASR (weather channel) input data, initial deployment of a storm motion algorithm is expected to be successful. Monitoring and scoring the performance of the algorithm in its storm motion capacity will continue. However, special emphasis will be placed on examining the usefulness of this type of algorithm in supporting the microburst prediction algorithm and as a method of tracking winter snow band structures. Beginning in FY92 and continuing throughout FY93, the processing of VIL data already in hand will be examined, and integration with the microburst algorithm will begin in FY93. For examining snow band tracking, winter storm data was obtained from NCAR and will be analyzed in FY93. The intention is to

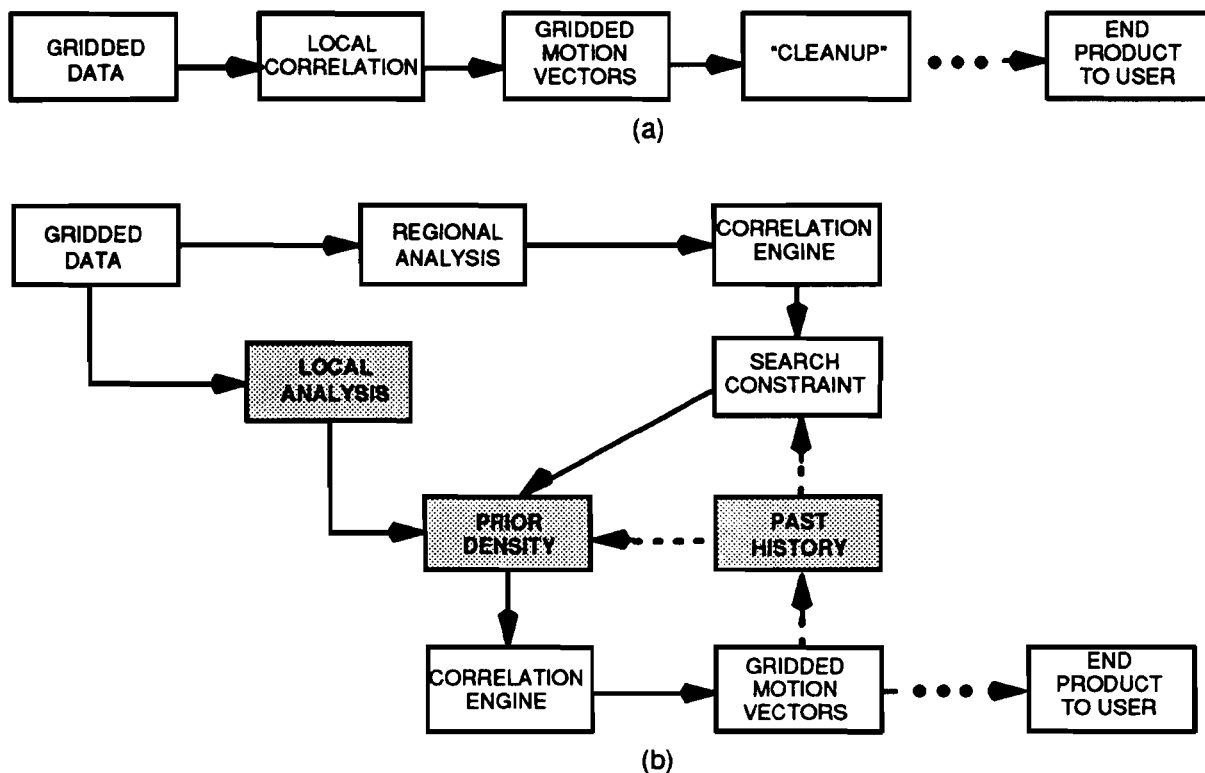

Figure 17. Development of correlation tracking algorithm. Part (a) shows the approach to analysis used in the TDWR prototype, and (b) shows the elements being explored to develop a new correlation processor. Shaded elements and broken pathways are incomplete as of the end of FY92.

provide a complimentary analysis (focusing on correlation processing) to the work being performed at NCAR on tracking winter storms.

2.8. TERMINAL WEATHER-IMPACTED AIRSPACE (WIA) ALGORITHM

The objective of the Terminal Weather-Impacted Airspace (WIA) product is to identify airspace that pilots are likely to avoid because they contain weather hazardous to aircraft and to present that information to the aviation user community (e.g., pilots, air traffic controllers and supervisors, and automated route planning systems). Pilots could use the information for route planning and to increase safety by avoiding hazardous airspace. ATC controllers and supervisors would use the information to anticipate pilot requests for deviations around weather and devise routes that avoid the hazardous airspace. In addition, automated route planning systems such as TATCA CTAS need Terminal WIA information to determine suitable terminal area aircraft routes.

The Terminal WIA relies on the integration of pencil-beam data and products and Air Surveillance Radar (ASR-9) Weather Channel data. ASR-9 radars are useful because they cover the entire airspace of interest, perform a volume update at roughly 30-second intervals, and will be the weather representation provided to the TRACON and controllers. On the

other hand, the ASR-9 has a 4.8-degree fan beam which results in a vertical integration over the depth of a storm, so information on the vertical structure of storms is lost. If the precipitation only partially or non-uniformly fills the beam (e.g., the “cone of silence” over the radar), the vertically integrated reflectivity may underestimate the actual intensity of the storm [5]. In addition, the current ASR-9 Weather Channel may produce false weather regions during ducting or anomalous propagation (AP) conditions [1]. Nearby WSR-88D radars also cover the entire airspace of interest and provide indications of storm vertical structure. However, the volume update rate is typically on the order of 5 to 10 minutes, depending on the scanning strategy. TDWR radars perform volume updates about every 2.5 to 3 minutes, but perform sector scans that do not cover the entire airspace. Integration of the data from these various sensors produces a storm location product that is superior to a product based on any single sensor.

The approach taken for the IOC Terminal WIA is primarily one of product integration. Figure 18 outlines the logic of the Terminal WIA algorithm. Six-level weather data are acquired from operational Air Surveillance Radars (ASR-9) and used to create a mosaic to help alleviate the problem of incomplete beamfilling. Anomalous propagation is then edited from the mosaic by comparing the ASR-9 weather to composite maximum reflectivity data from

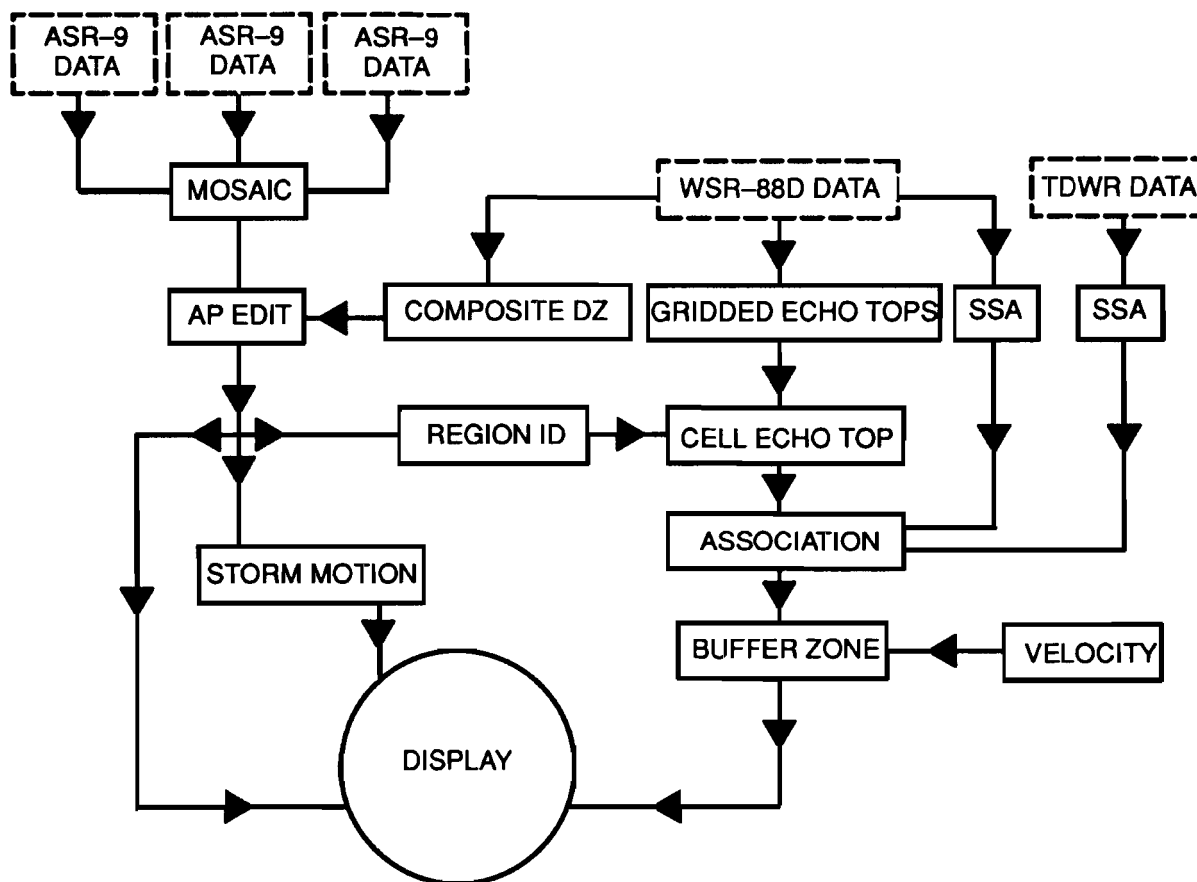

Figure 18. Terminal WIA algorithm logic.

nearby pencil-beam radars. If the weather level at each ASR-9 grid point cannot be confirmed by pencil-beam reflectivity data, the datum is either set to a value supported by the pencil-beam data or removed completely. The edited data are then sent directly to the display (e.g., the GSD) to be used as the precipitation product, to the Storm Motion Algorithm to produce estimates of storm motion, and to a cell-finding algorithm for further analysis.

The cell-finding algorithm identifies regions of heavy rain (level 5 and greater), as well as cells containing level 3 and greater. Gridded echo top data from pencil-beam radars are searched in the vicinity of the ASR-9 regions to provide an estimate of cell echo top. The outputs from a variety of hazard detection algorithms (e.g., hail, mesocyclone, and tornado) running on WSR-88D and TDWR data and lightning data from the National Lightning Network are acquired and associated to hazard regions. Buffer zones around the hazard regions are constructed to enhance safety. The output of the algorithm is passed to the display.

2.8.1. FY92 Accomplishments

During FY92, meetings were held to define the components of the WIA product and to coordinate efforts among the various algorithm developers (NCAR and NSSL). Hazards to be detected include heavy rain, hail, mesocyclones, and tornadoes. Airspace will be identified as hazardous to aviation based on the presence of these hazards. Ancillary information about storm echo top and lightning flash rate will be provided.

During the summer of 1992 an algorithm to compute lightning flash rate was demonstrated. The VHF lightning sources were received over a serial link from Office National d'Etudes et de Recherches Aeronautiques (ONERA) interferometers. This algorithm required cells tracked in ASR-9 six-level data. A methodology for finding and tracking cells was devised based on the TDWR storm motion algorithm. The VHF sources were grouped into flashes and flashrates and calculated at a user-defined update rate. The storm motion algorithm provide a storm centroid, which was related to the highest reflectivity level in the storm, and a motion vector. Lightning flashes were associated with the centroid which was tracked based on the motion vector. Once flash rate was determined, computation of echo top (a fifth-power relationship) was performed by the lightning-based echo top algorithm (LETA). LETA was run in real time during the summer, but was not displayed to users until an assessment of its performance could be conducted. Preliminary work on LETA showed that mean errors of less than 10 kft were achievable on the initial data set.

Code to perform the mosaic of ASR-9 data was developed and tested. Because of the beamfilling loss problem, [5] the ASR-9 radar may underestimate the intensity of storms very near to and very far from the radar (figure 19). An example of such underestimation is illustrated in figure 20. A storm containing at 55 dBZ located 5 km northwest of the ASR-9 does not appear in the ASR-9 data. Similarly, a 60 dBZ storm 40 km to the east of the ASR-9 is represented as level 2 weather. Creating a mosaic of more than one ASR-9 or of ASR-9 and pencil-beam data would alleviate this problem.

An algorithm to perform AP editing was implemented and preliminary tests were conducted. The algorithm compares a grid point of the ASR-9 data to the composite maximum reflectivity from pencil-beam radar. If reflectivity values in the pencil beam data do not confirm the weather levels in the ASR-9 data, the weather levels are changed to agree with the pencil-beam data.

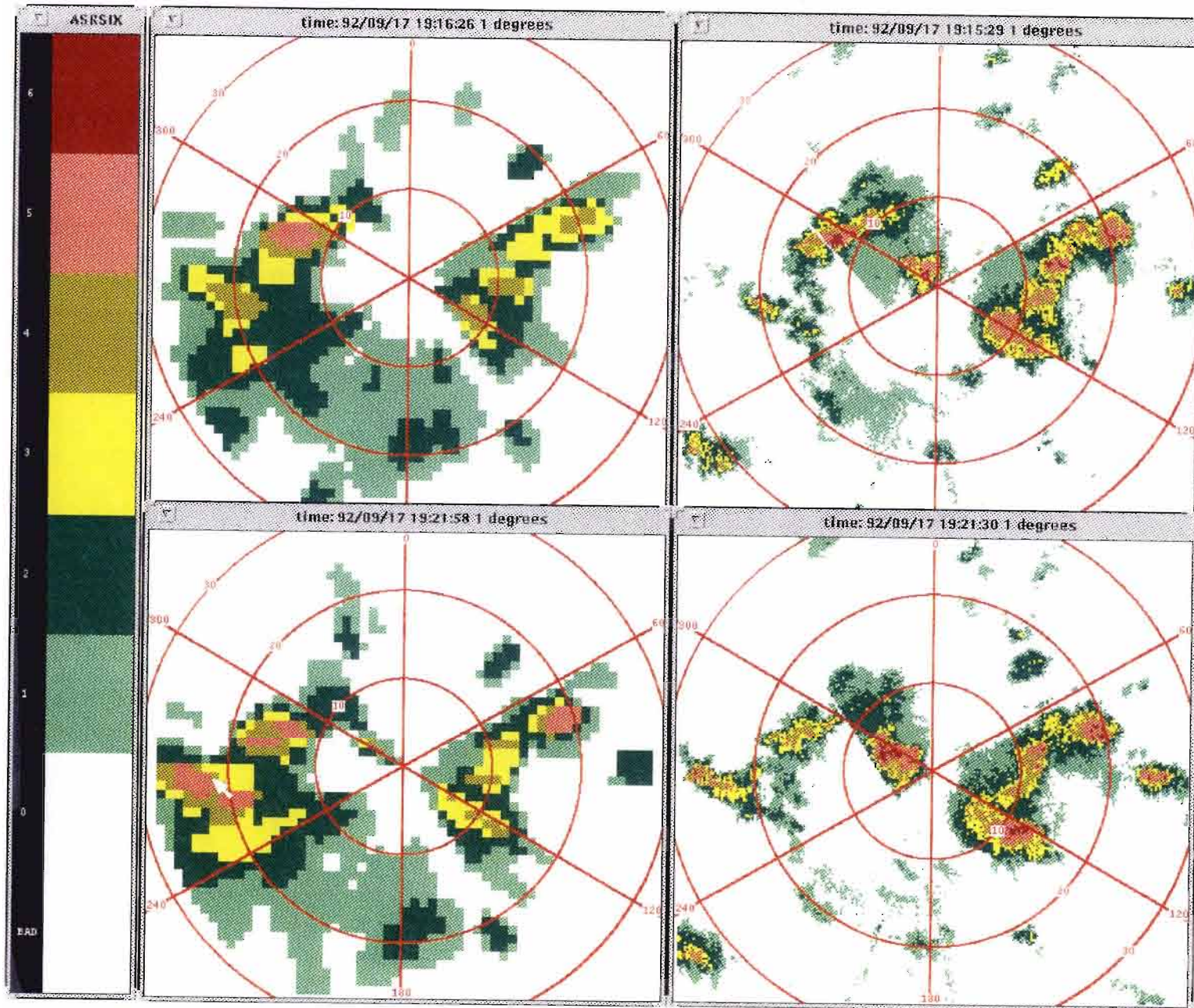

Figure 19. Example of weather data illustrating the need to create a mosaic of ASR-9 and pencil-beam radar data. The images at the left show weather data gathered by the ASR-9 testbed radar on 17 September 1992. The images at the right are composite maximum reflectivity created from the TDWR testbed data for the same day. The colors correspond to the National Weather Service precipitation scale. The TDWR testbed data at 19:15:29 (upper right) indicate the presence of a level 6 storm 5 km northwest of the ASR-9 testbed data. Similarly, at 19:21, the TDWR testbed radar shows a level 5 storm 25 km east of the ASR-9 testbed radar that is represented as a level 2 storm in the ASR-9 testbed data.

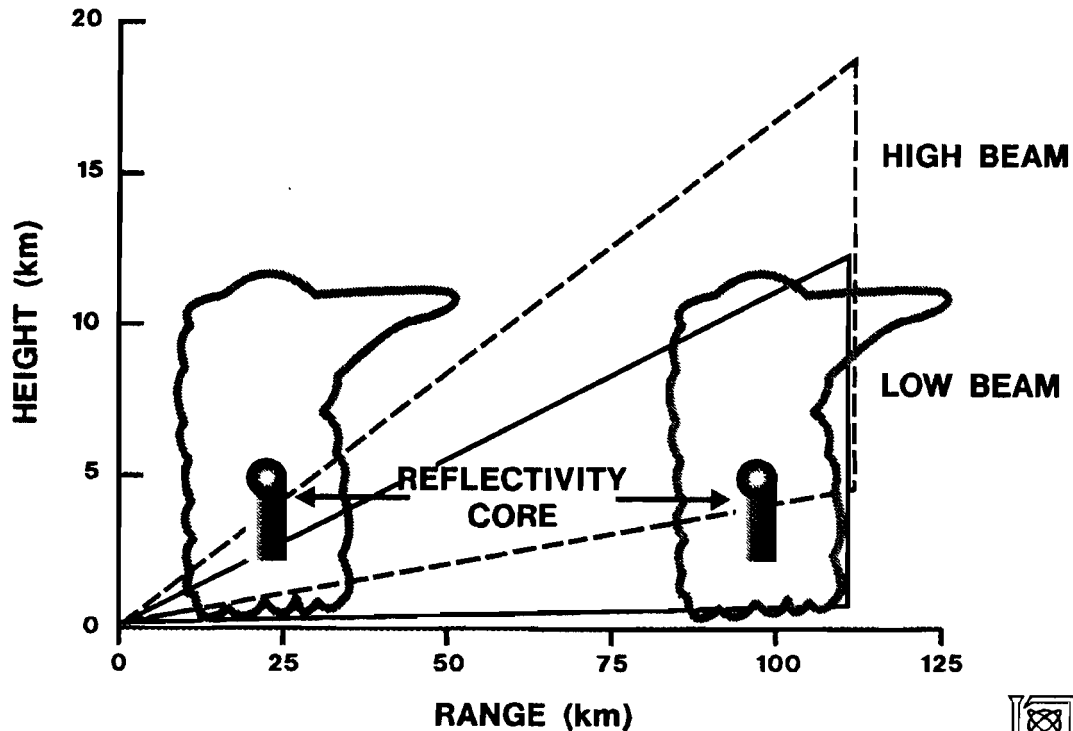

Figure 20. ASR-9 radars underestimation of intensities of storms located near to (~25 km) and far away from (~100 km) the radar.

The ability to identify cells in ASR-9 data was implemented and tested. The code is similar to the NSSL approach in that it searches for regions above specified thresholds (specifically level 3, 4, and 5 weather). The highest weather level within an area is defined as the cell. Code to estimate echo top for all identified cells was implemented. Bounding boxes are constructed around the cells and the echo top product within those boxes is searched. The highest echo top in the box is assigned to the cell.

The NSSL hazard detection code (Severe Storms Analysis or SSA package) was ported to the Lincoln computing system. In addition to cell identification and tracking, SSA provides hail and mesocyclone detections. Code was implemented to extract intermediate products and final detections. This code supports off-line analysis and real-time demonstrations.

Rules for the association of hazards to hazard regions were specified. Hail detections will be associated to the nearest reflectivity region; mesocyclone and tornado detections will stand as separate hazard regions.

The display concept for the IOC WIA product was specified. The basic display will look very similar to the TDWR GSD. Echo tops, storm motion, and lightning flash rate can be displayed for all storm cells exhibiting level 3 or greater. These features will be user-selectable by clicking on various buttons. Regions that are hazardous due to the presence of meso-

cyclones, tornadoes, heavy rain and/or hail will be identified by shapes overlaid on the precipitation product. Each shape will contain an icon which, when selected by the user, will display text listing the hazards associated with the region. In this way, users can obtain more information on a region of interest while keeping the display uncluttered.

Various studies were conducted throughout FY92 to support algorithm development. A study was performed that looked at the errors associated with creating a mosaic of data separated in time by about 30 seconds. The results of this study were published in an internal memo in October.

A study was conducted to characterize the rate of change in area of cells as seen in six-level ASR-9 radar data. This study supports the characterization of hazards, the determination of an appropriate buffer zone, and the determination of error introduced into a mosaic due to storm evolution.

Input from the user community concerning the "look and feel" of the product and necessary performance capability is essential for user acceptance. In order to obtain this input, a list of issues were formulated and provided to NCAR for referral to the Aviation Weather Development Laboratory (AWDL) Product Advisory Review Committee (PARC).

2.8.2. Work for End-State WIA

Analysis began on data to support the detection of updrafts and downdrafts. Analysis of an electrically active storm using triple-Doppler winds was not conclusive. Significant charging probably occurs when the storm forms to the west of the triple region. Electrical activity occurring inside the triple region may be the result of residual charge in the clouds, and thus no clear relationship between updraft and electrical activity was found.

Early in FY92, an attempt was begun to perform three-dimensional analysis of pencil-beam data to identify weather-impacted airspace. It became evident that this technique, though promising, would not yield the desired results in the IOC time frame. An alternate development path for IOC Terminal WIA was defined. It is expected that work on the three-dimensional approach will be useful for the end-state Terminal WIA product.

Work to support the three-dimensional analysis technique included implementing a generic Cartesian image manipulation package to facilitate experimentation with two-dimensional image processing and developing software for contour analysis of data.

2.8.3. FY93 Plans and Issues

Off-line evaluation of the various processes will be conducted to ensure that no bugs exist in the code and to assess performance. For example, the AP editing technique contains a number of user-selectable parameters. The performance of the algorithm will be assessed and optimal parameter values will be chosen. It was originally planned that only ASR-9 data would be used to create a mosaic. However, in many instances there will be only one ASR-9 radar covering an airport. Using pencil-beam data as input to the mosaic process seems feasible and will be investigated.

Interprocess communication issues for real-time demonstration of the algorithm need to be addressed. Field tests of components of this algorithm are planned at DFW and MCO during the summer of 1993. The objectives of these tests are to evaluate the technical performance of the algorithm and then validate the operational concept.

An assessment of various cell-finding and cell-tracking techniques will be performed to determine which technique (or combination of techniques) is most appropriate for creating five- to 10-minute forecasts of weather impacted airspace. Mike Dixon (NCAR) was contacted and has agreed to provide Lincoln with the TITAN (Thunderstorm Identification, Tracking, Analysis, and Nowcasting) algorithm.

2.9. LIGHTNING DETECTION

2.9.1. Background

For the past three years, Lincoln has collaborated with various Government and university laboratories to obtain a data base for understanding applications of lightning measurements to the nowcasting of convective weather hazards. A French laboratory, ONERA, deployed a two-station interferometric system that provided real-time, high-resolution detection and localization of both cloud-to-ground (CG) and intracloud (IC) lightning activity. Supporting measurements were obtained from a single-station lightning mapping system operated by New Mexico Tech, an all-sky video camera system operated by the National Severe Storms Laboratory (NSSL), and sensors to document the electric field structure at the ground beneath thunderstorms. These data are being used to do the following:

1. Demonstrate the consistent coupling between lightning activity and storm structural and dynamic features such as updraft strength and upwards motion of ice-phase precipitation in the middle levels of the thunderstorm;
2. Develop applications of lightning data to aviation weather nowcasting based on these phenomenological relationships. Specific applications will include the refinement of the buffer zone generated around radar echoes by the Weather Impacted Airspace Algorithm, microburst prediction, storm growth or dissipation forecasting, and warning/prediction of CG lightning that endangers airline ground operations personnel; and
3. Evaluate operational application of the real-time total lightning detection capability of the ONERA system at an airline ground operations center at MCO.

2.9.2. FY92 Accomplishments

This section highlights initial phenomenological studies that form the basis for developing applications of lightning measurement to ITWS products. The Lincoln sensing facilities near the airport in Orlando, Florida provided a unique opportunity to test the interrelationships of lightning activity and storm intensity parameters. The storm electrical measurements described above were compared to thunderstorm structure and wind fields derived from the triple-Doppler radar network in order to:

1. Directly test the coupling of electrical activity to the thunderstorm updraft — a parameter not directly measurable with operational single-Doppler radars such as TDWR and WSR-88D;
2. Determine, in turn, relationships between updraft strength and storm severity and the temporal relationship between the updraft's life cycle and growth and dissipation of the storm.

Wind vector synthesis from the triple-Doppler radar measurements was accomplished using a hybrid analysis technique [6]. At high altitude where the measured radial winds contain substantial contributions from both horizontal and vertical wind components, a direct coordinate transformation of the three radial velocity measurements can be used to express the wind vector in Cartesian components. At low altitudes where the Doppler measurements are dominated by the horizontal wind component, the vertical wind is determined via integration of the mass continuity equation downwards from a boundary condition established at the bottom of the domain of direct measurements. Using this technique, vertical velocity estimate errors are maintained at values of approximately 1 to 3 meters RMS within most of the area defined by the three radars.

After some delays in deployment, the ONERA lightning mapping system provided detection and three-dimensional localization of both CG and IC lightning throughout August. This system uses interferometric techniques to perform direction finding to radio noise sources (~110 MHz) generated by the lightning discharge; triangulation between two such direction-finding stations yields x,y,z coordinates for sources along the lightning channel. Signals are archived at each station for post-analysis, and a subset of the data were used to calculate and display horizontal coordinates of the lightning activity in real time.

Figures 21, 22, and 23 summarize the relationship between lightning activity and the structure and dynamics of an isolated airmass thunderstorm on 18 August 1992. Figure 21 compares the time development of the storm's lightning flash rate to the updraft magnitude within the mixed phase region (5–8 km altitude) and the storm's vertically integrated liquid water content (VIL). Initial electrification — as indicated by the onset of strong electric field beneath the thunderstorm — and subsequent beginning and intensification of lightning occur during the interval of strong updraft and increasing VIL. When the mid-level updraft dies, flash rate and storm VIL begin decreasing within one volume scan as the storm enters its dissipating phase. Figure 22 shows vertical cross sections of reflectivity and wind structure during the intensifying (time < 00:19) and dissipating stages of the storm (00:22–00:28). These confirm that the cutoff in lighting activity coincides with the quenching of the mid-level updraft and subsequent collapse of the high-reflectivity turret above 5 km altitude. In Figure 23, the spatial relationship of the VHF activity to the updraft is illustrated during the

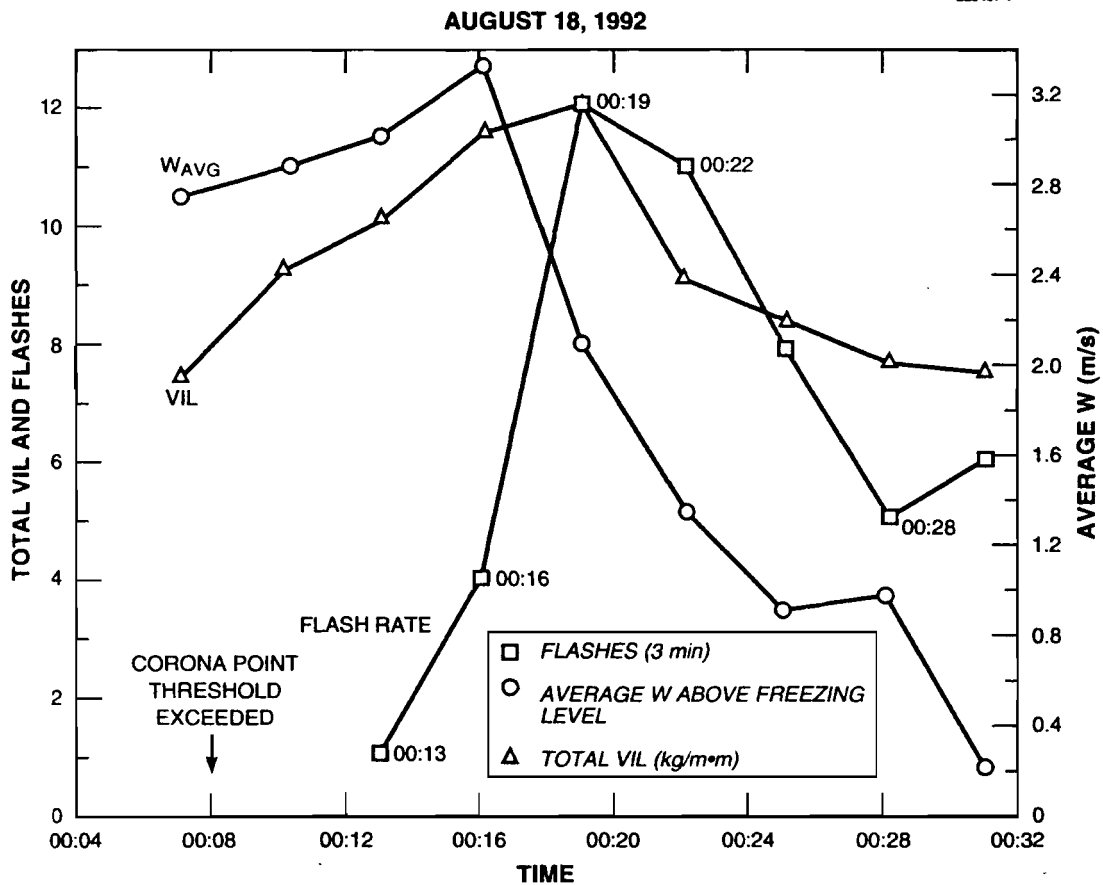

Figure 21. Flash rate, vertically integrated liquid water content (VIL) and average updraft in the mixed phase region (5 km to 8 km altitude) versus time during an isolated thunderstorm on 18 August 1992.

intensifying phase of the storm. The volume rendering, as described in the figure caption, shows reflectivity cores, updraft (>10m/s) and lightning radiation sources. Referring to Figure 22, the flow pattern is out of the south, up over the highest reflectivity core, and on up into the thunderstorm's turret. At this time, the VHF sources are seen to be organized by the updraft into a narrow column defining the region of active charge separation.

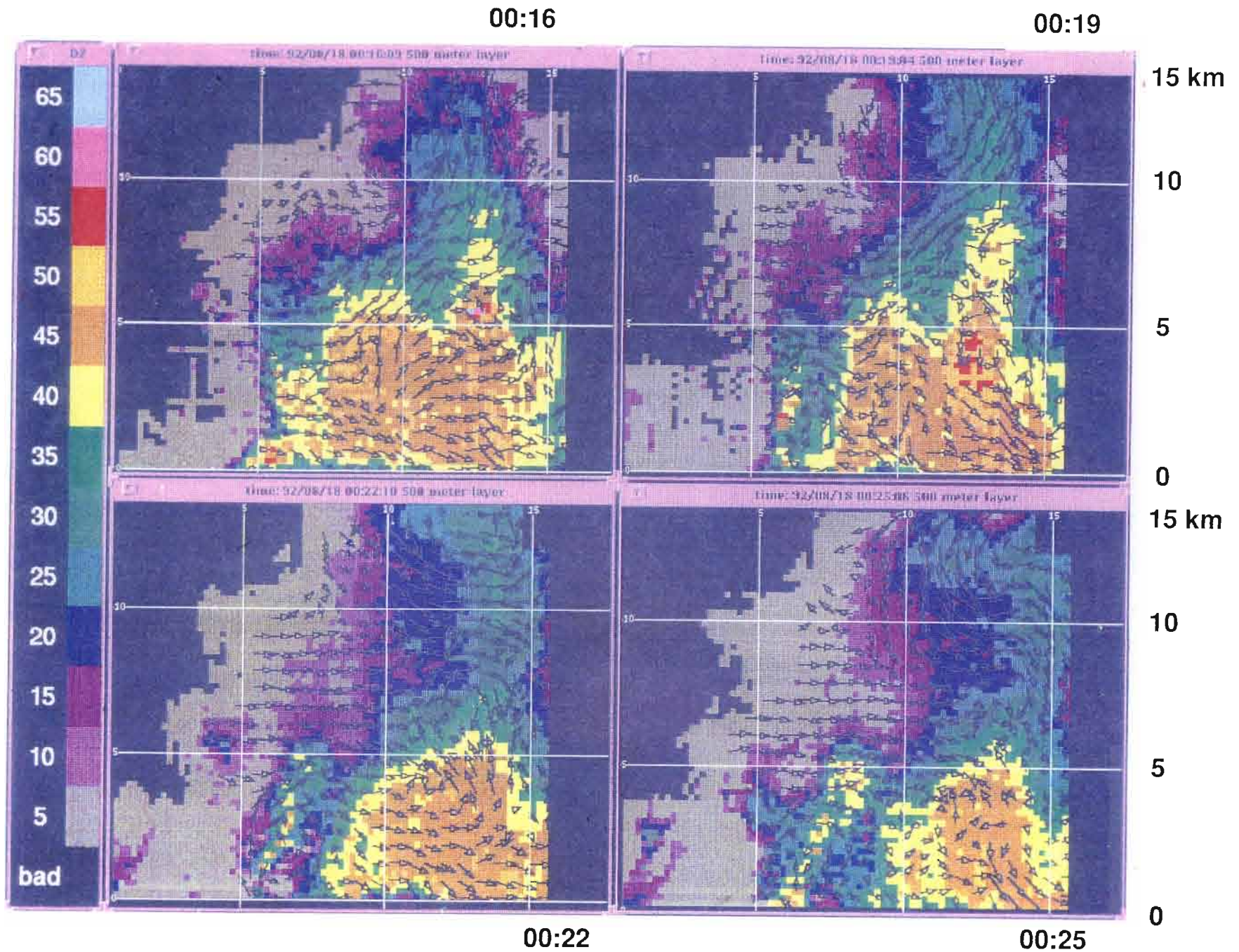

Figure 22. Vertical cross sections of reflectivity in a north-south oriented plane. Wind vectors from the tri-Doppler analysis are projected into the plane of the figure.

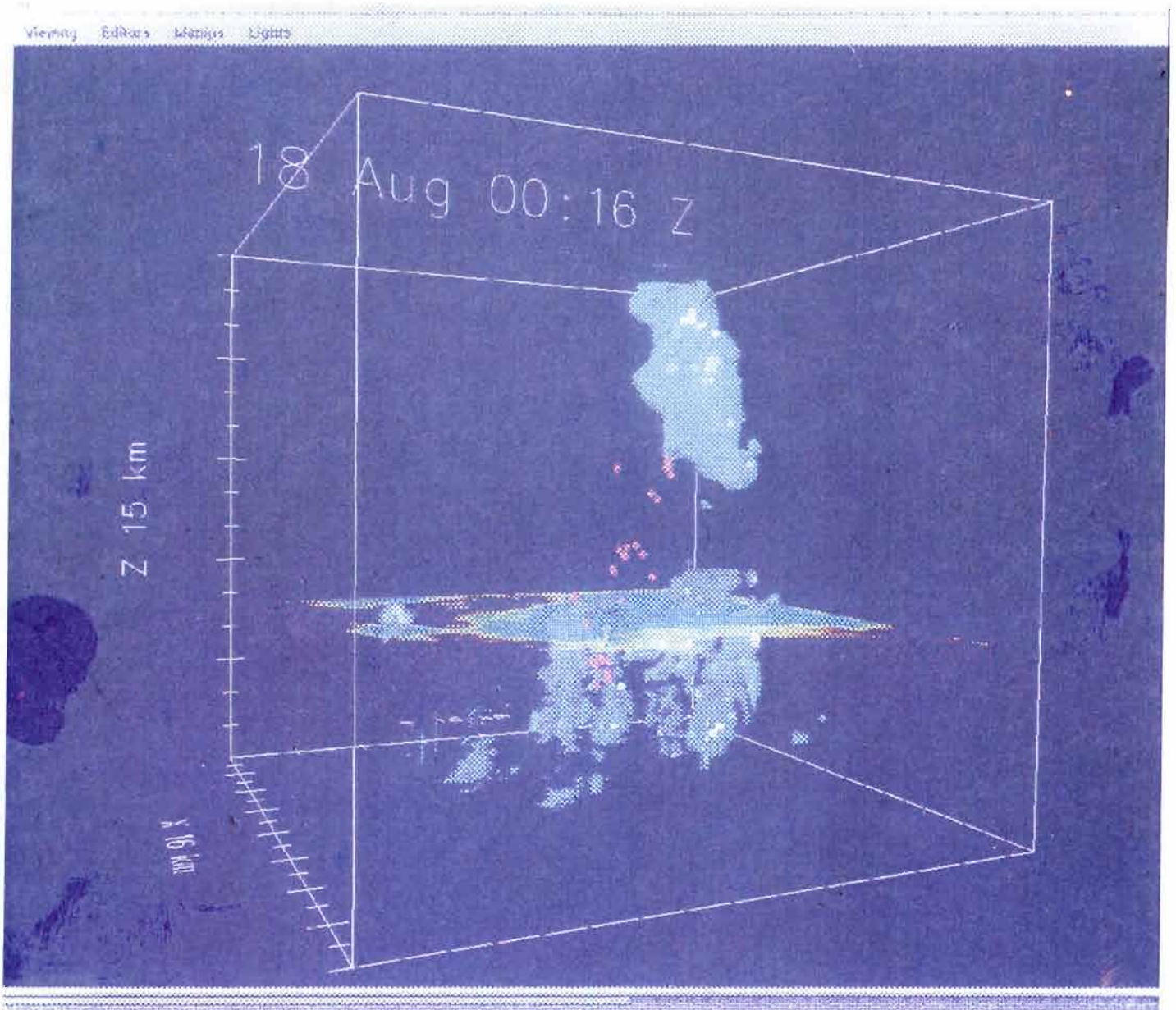

Figure 23. Volume reflectivity of significant storm parameters during intensifying phase of the thunderstorm. The rain core ($\text{dBz} > 50$) is shown in blue, the region of updraft exceeding 10 m/s is shown in green, lightning sources are shown in pink and the horizontal plane is the melting level (~ 5 km). The storm is being viewed from the east and the coordinate origin is near the location of the TDWR tesbed at the southern apex of the tri-Doppler network.

3. PROTOTYPE DESIGN

3.1. BACKGROUND

The purpose of the functional prototype is to provide a real-time testbed for evaluating and refining the ITWS concepts, demonstrating the feasibility of real-time data access, and identifying deficiencies in data and product sources. A functional prototype also will support risk reduction efforts for the ITWS implementation alternative and provide an interim ITWS functional capability from 1996 through 1999. Developing such a prototype involves defining the architecture, developing interfaces to data sources, and developing the software and procedures that create the prototype infrastructure. It is particularly important to support drop-in algorithm testing and provide configuration control for multiple installations.

3.2. FY92 ACCOMPLISHMENTS

The TDWR testbed (FL-2) was extended to allow support for preliminary ITWS testing. Access to NEXRAD wideband and narrowband data in Melbourne, FL was accomplished, and MAPS data from FSL and surface observations (ASOS/AWOS) via NASA were acquired. A T-LAPS processing capability was added, and user-to-user display interactions were provided to support creation of surrogate ITWS products. The interface between ITWS and TATCA (FAST) for wind and temperature data was defined, and plans were developed to establish an ITWS-TATCA connection at Lincoln.

Possible future testbed architectures were explored. A prime consideration is that there must be an evolutionary path from the current TDWR testbed to the eventual ITWS functional prototype. An additional consideration is that the functional prototype should be able to be used to demonstrate the ITWS implementation alternative currently favored. Figure 24a shows a likely early architecture for the prototype; figure 24b shows a candidate final architecture.

3.3. FY93 PLANS AND ISSUES

Planned work for the upcoming fiscal year include finalizing the testbed evolutionary concept and the target architectural design of the prototype as well as procuring a certain amount of hardware (compute engines for T-LAPS and possibly a data/communications server), developing procedures for managing the target prototype, resolving near-term issues with regards to interfaces for ACARS, ASOS/AWOS, UND base data (if required), and resolving longer-term issues regarding interfaces for production NEXRAD and TDWR base data.

The complicating factors for these tasks are the uncertainty regarding the importance of (completely) demonstrating the chosen ITWS implementation alternative and uncertainty regarding reliability requirements (which might imply features such as hardware and communications redundancy) for ITWS functional prototype systems serving as interim operational systems from 1995 to 1999.

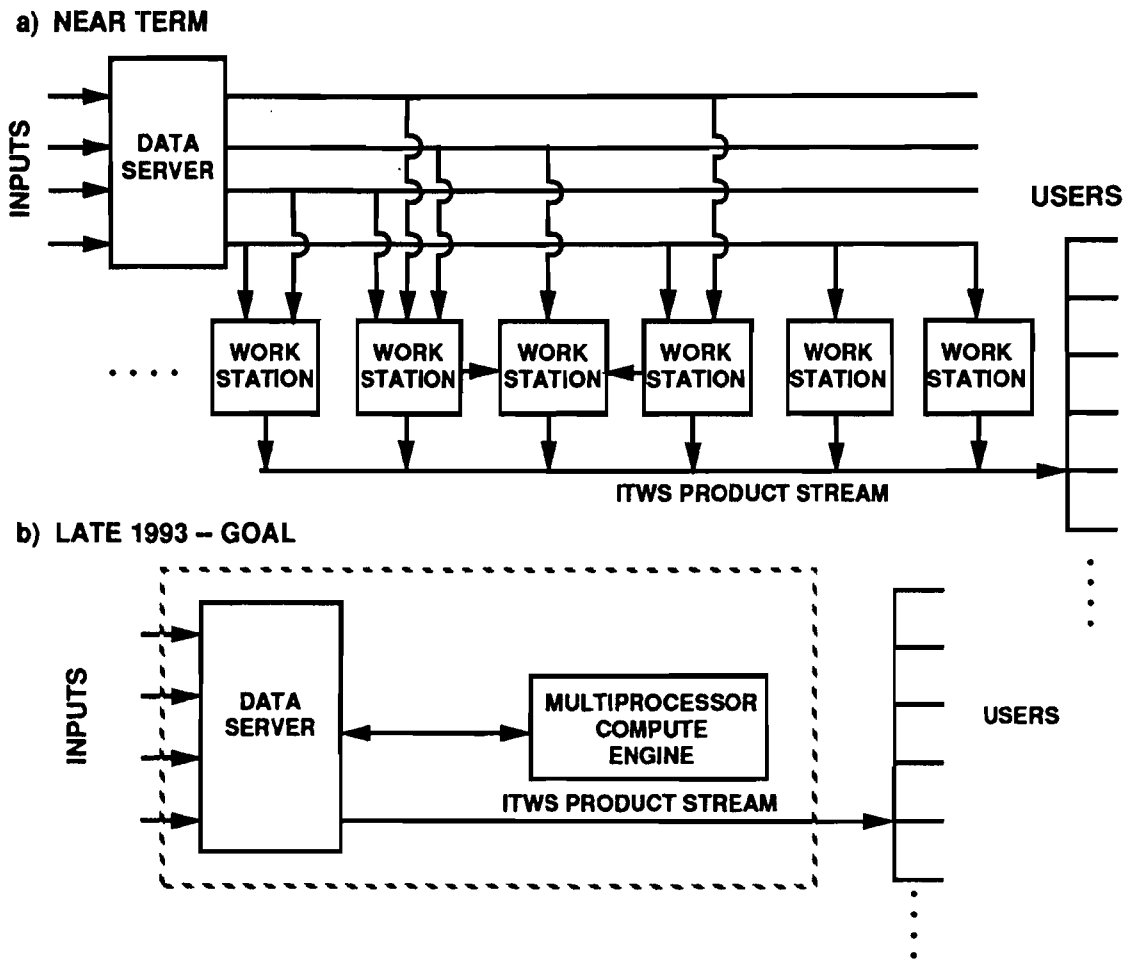

Figure 24. Functional prototype architecture.

number of cases will be shown to relate the intensity of each event according to variables which are more applicable to the hazard presented to an aircraft. Finally, the significant individual weather events such as hailstorms, heavy rainfall and severe wind shears will be described.

Figure 25 shows the monthly distribution of microbursts and gust fronts in Orlando during 1992. Wind shear events were detected in every month except February and December. Most of the weather during these months was late in the evening, which precluded any data collection. Due to the mild/warm temperatures and closeness to the moisture supply, wind shear events could be expected at any time of the year in central Florida. The most active period was June through September. The maximum number of microbursts in one month was 496 in August. There were fewer events in the winter months due to a lack of thunderstorms during this time of the year. Thunderstorm activity from the late fall to early spring is primarily caused by cold fronts, which occur on an irregular basis. By comparison, afternoon convection and sea breeze activity dominate the spring and summer seasons with almost daily thunderstorm activity. The distribution of wind shear events in July is biased downward since the radar did not operate for nine days due to a lightning strike. Overall, there were 1645 microbursts and 288 gust/sea breeze fronts detected by the radar. This amounts to an average of 10 microbursts per operational day. Orlando has been the most consistently active TDWR testbed locale in regard to the number of microburst events.

The maximum radial velocity distribution of the 1992 microbursts is presented in Figure 26. The distribution shows that the maximum velocity in slightly more than one-half of the events was less than 15 m/s. Thus, the majority of microbursts in Orlando would be classified as wind shears since the intensity was less than 15 m/s. Approximately one-third of the cases were of moderate intensity, with maximum radial velocities between 15 and 19 m/s. There were approximately 300 events from Orlando which would be classified as “strong,” with maximum velocities of 20 m/s or greater. The strongest microburst attained a peak radial velocity of 42 m/s. In fact, a number of the most severe outflows were recorded in a two-day period on 6 and 7 July. This data is similar to results from previous TDWR testbed experiments which show that the majority of the microburst events are categorized as weak.

The current TDWR microburst detection algorithm uses radial velocity to detect a wind shear. Thus, during the latter stages of an event when it spreads out horizontally, the hazard

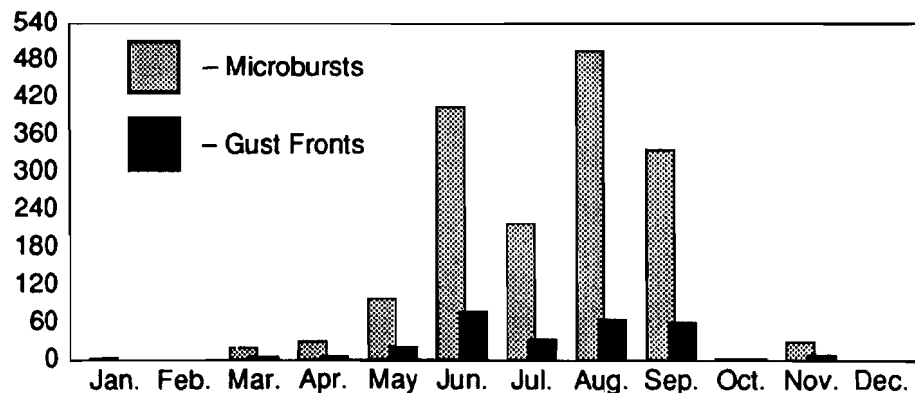

Figure 25. 1992 Orlando monthly distribution of microbursts and gust fronts.

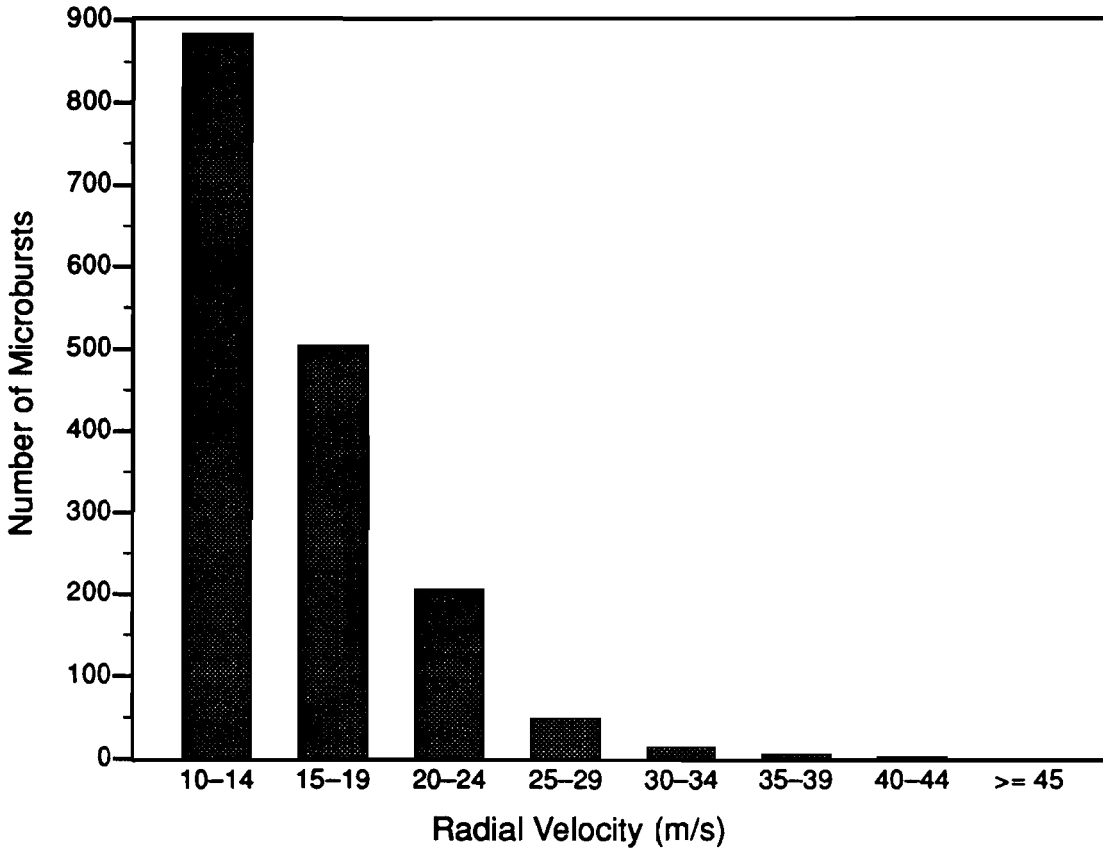

Figure 26. Distribution of maximum radial velocity in 1992 Orlando microbursts.

would decrease even if the velocity remained nearly the same. A more accurate method to determine the hazard associated with a microburst is by the radial shear, which is defined as the velocity change across a given distance. This technique has the advantage of reducing the hazard associated with an event when it has expanded in size.

Figure 27 shows the probability distribution (percent) of the average radial shear (m/s per km) for a select number of Orlando microbursts. The data in this figure represent the average shear value across the microburst's extent for each minute it exceeded the 10 m/s threshold. Approximately one-third of the cases attained shears of 5 m/s per km or less, while only 10 percent reached 10 m/s per km or greater. Thus, the majority of Orlando microburst shears (55 percent) ranged between 5 and 10 m/s per km. The strongest event in Orlando produced an average radial shear of 29 m/s per km.

Once the average radial shear has been obtained it can be converted into an F factor, which is a better estimate of the hazard a wind shear would present to an airplane. According to Targ and Bowles [7], an F factor of 0.13 is the nominal value for aircraft performance to be marginal for level flight. Based on this criteria, only eight percent of the Orlando events would be considered hazardous on a minute-by-minute basis (figure 28). The ITWS microburst detection algorithm is currently using an F factor of 0.10 to identify high shear regions within an outflow. Approximately one quarter of the cases achieved F factors of at least 0.1. It should be pointed out that the hazard estimates provided by the shear and F factor analysis presented here are biased downwards. These statistics were obtained by determining the

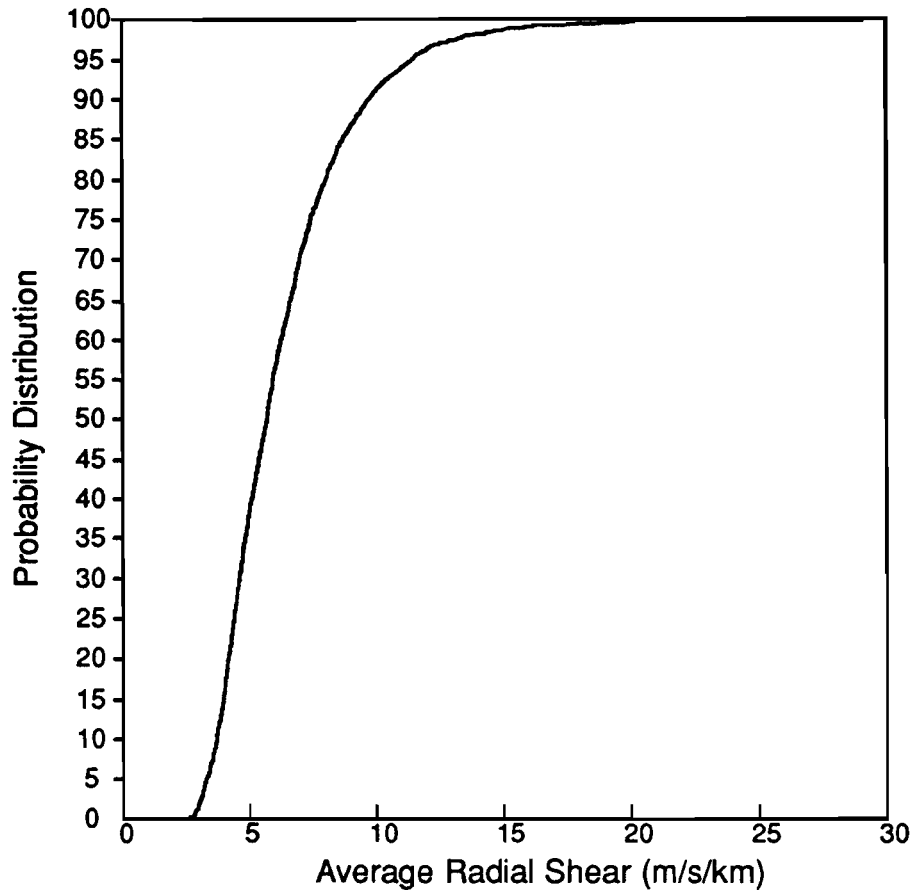

Figure 27. Minute-by-minute distribution of average radial shear in 1992 Orlando microbursts.

maximum radial velocity difference across the entire length of the event. The current procedure used by the ITWS algorithm is to compute the peak shear over a 1 km distance. Thus, the peak shear would exceed the average shear in a vast majority of the cases. Nevertheless, the shear or F factor is a better representation of the hazard than radial velocity.

While there were wind shear events recorded on almost every day the radar operated, the number of severe weather days were more limited. A description of four of the most interesting weather events from 1992 is presented below. Two major hailstorms were recorded in Orlando on 6 and 25 March. The third event was a heavy rainfall episode on 30 June. The final case which will be discussed was a significant lightning storm and severe wind shear events on 7 July.

Both of the hailstorm cases were associated with cold fronts which tracked through central Florida. During the early spring, the fronts are usually strong enough to produce severe weather in the area. The event on 6 March occurred in the late afternoon hours, producing dime- to golf-ball-size hail. Some structural and tree damage was reported from the strong microburst winds associated with this system. The hail reached a depth of two to three inches in some locales. The second hailstorm occurred three weeks later on the evening of 25 March. In this episode, the hail reached baseball size, which is more akin to severe weath-

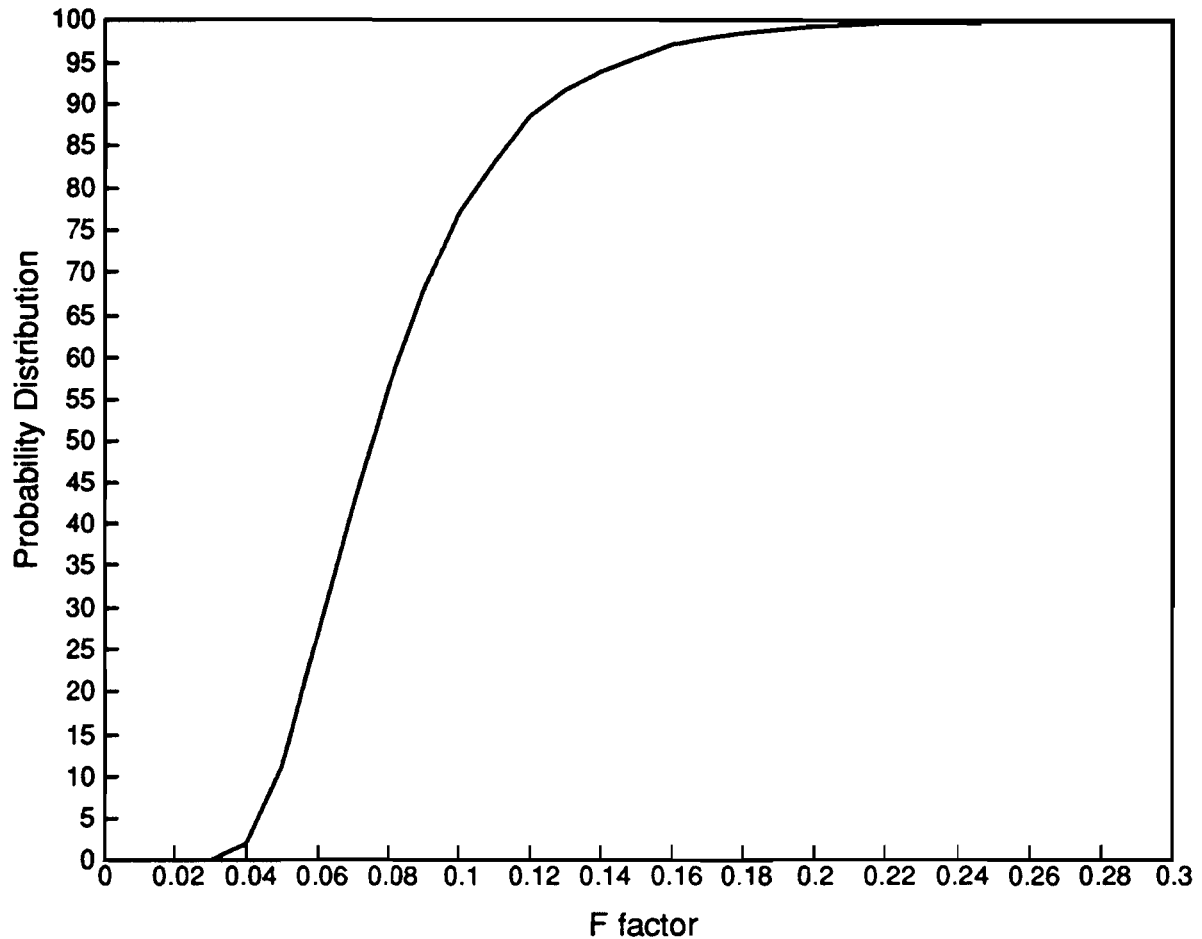

Figure 28. Minute-by-minute distribution of F factor in 1992 Orlando microbursts.

er events in the Great Plains. The duration of this event was three hours, which was three times longer than the previous case. There were reports of extensive damage to homes and cars in the path of the storm.

The radar data from 25 March showed several indications of the severity of the storm. First, the maximum reflectivity in the core of the storm exceeded 60 dBz to a height above the freezing layer. Second, the reflectivity cores were tilted almost 45 degrees from vertical, with strong updraft/inflow winds detected below the tilted core. Also, the upper-level divergence at the storm top exceeded 50 m/s, which is typically an indication of strong updrafts capable of supporting large hail. In terms of winds, the near-surface velocities peaked in excess of 30 m/s on this day. A strong gust front with a maximum wind gust of 52 mph crossed the airport. Significant gains of 30 knots were issued by the algorithm when the front crossed MCO. Several tornadoes were originally reported on 25 March; however, they were not verified by surface spotters. The tornado vortex signature (TVS) algorithm did detect a tornado signature in a line echo wave pattern (LEWP) where the most significant hail was produced.

One of the most convectively active days of the 1992 data collection season was 30 June. Moderate instability and strong vertical wind shear over Central Florida established the po-

tential for squall lines to develop once thunderstorm activity began. By 1600Z, a north–south oriented line of thunderstorms had formed east of Orlando. The line progressed eastward, and by 1730Z developed a classic bow echo structure west of Cape Canaveral. Prior to moving off the coast, the line produced half–inch hail and surface winds in excess of 50 knots. This line also produced a distinct outflow boundary just east of MCO.

By 2000Z, the bow echo moved off into the Atlantic and developed into a meso–low. At 2100Z, the mesoscale surface analysis and concurrent satellite interpretation by the NWS office in Melbourne revealed a phenomenon known as the “Tampa Bay shadow effect,” two parallel lines of enhanced cumulus clouds extending from Tampa to Orlando. The area between the two lines remained completely clear while cells advected up the line towards Orlando. This phenomenon occurs in the presence of deep, moderately strong westerly flow over Tampa Bay.

By 2100Z, strong cells had begun to develop over MCO. At 2057Z, the TDWR system issued an alert for a 60–knot loss. This event was confirmed by the UND radar, which reported a microburst strength of 70 knots. At this time, the control tower at MCO reported wind gusts to 50 knots. Microbursts associated with this strong line of cells produced alerts at MCO continuously until approximately 2200Z. A total of 50 microbursts were logged on this day as well as a total of 3.55 inches of rain. This rainfall total accounted for 25 percent of the month’s 14.7 inches.

Another exceptional day with regards to convective activity was 7 July. By 2020Z, the east coast sea–breeze front had advected into the MCO area and strong cells began to form. By 2100Z, three microbursts had impacted the runways, the strongest event resulting in an alphanumeric alert for a 60–knot loss on runway 17. Within a half hour most of the activity had moved off to the west and northwest. By 2220Z, several outflow boundaries collided in the vicinity of MCO, resulting in strong convection, rapid storm development, and intense lightning.

These cells produced several microbursts characterized by strong, fairly shallow outflows, rapid increase and decrease in strength, and small radial extent. Very strong F factors were observed in most of these events. The most notable of these microbursts occurred at 2305Z at a range of approximately 4 km from FL–2. At the time of peak intensity, a ΔV of 36 m/s was observed over a distance of 700 m. This converts into an F factor of 0.47, the highest observed in Orlando and considered extremely severe. Figure 29 shows the minute–by–minute plot of F factor for this event. The F factor remained above the nominal 0.10 threshold for approximately six minutes.

Three other events around this time also reached severe hazard levels above 0.24 F factor. Cells continued to develop over MCO, but a direct lightning strike to the FL–2 site at 2329Z resulted in extensive damage to a large portion of the electronic equipment. Repairs took nine days, and the radar was operational again on 16 July.

4.3. FY93 PLANS

The ITWS 1993 testing will focus on data acquisition for algorithm development, IOC product testing at MCO, and testing of some IOC products in a midwest environment at DFW. The bulk of the data acquisition effort will focus on the Orlando area since only Orlan-

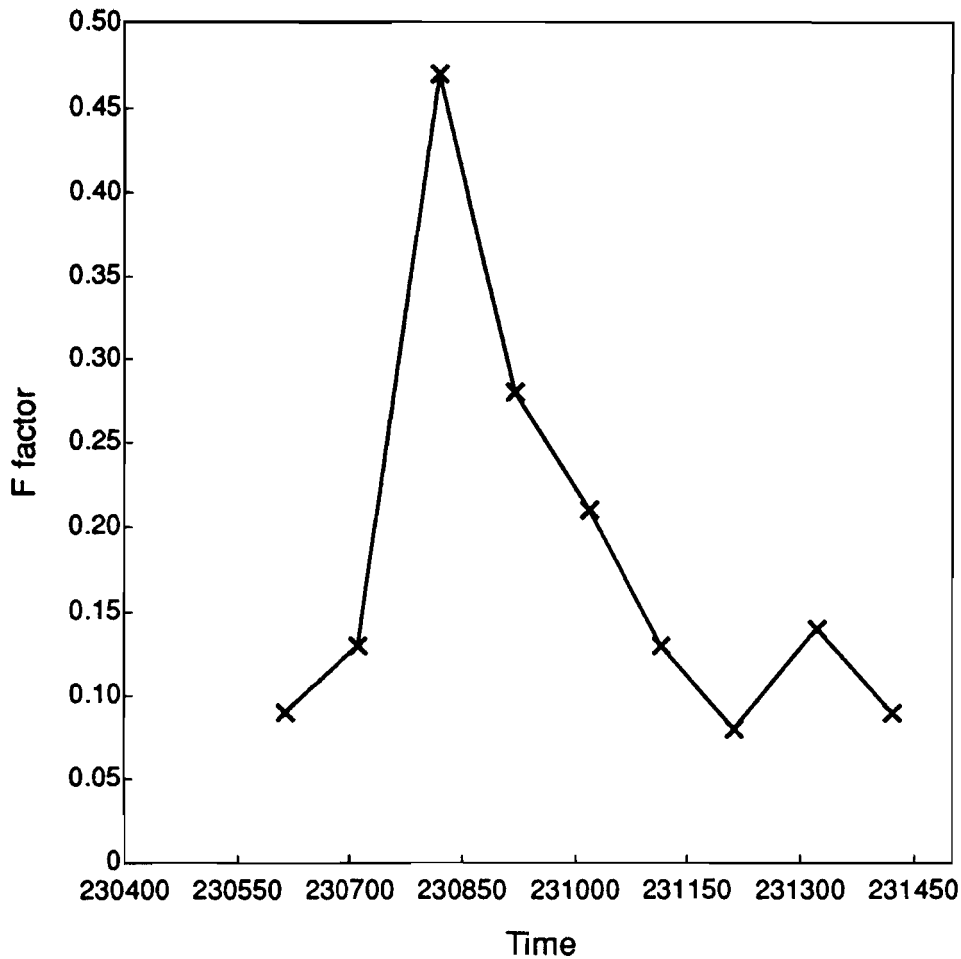

Figure 29. Minute-by-minute plot of F factor for a severe microburst on July 7, 1992.

do has both TDWR and NEXRAD systems. Additionally, Orlando has high-resolution lightning sensors. Data acquisition for all the sensors used in the 1992 Orlando tests will commence 1 May 1993 in the Orlando area using the TDWR/ITWS testbed.

TDWR and NEXRAD data will not be available in the DFW area until FY94. Hence, plans are being made to have the UND pencil-beam weather radar operate near DFW from March through early June. Data also will be obtained from an ASR-9 located near DFW and from ACARS-equipped aircraft.

Real-time products for DFW will be generated by a processing system located at Lexington, MA, with both the UND and ASR-9 weather channel data being transferred by wide bandwidth data lines. The distribution of hazardous cell and storm motion products will be accomplished by a system located at DFW airport as indicated in Figure 30.

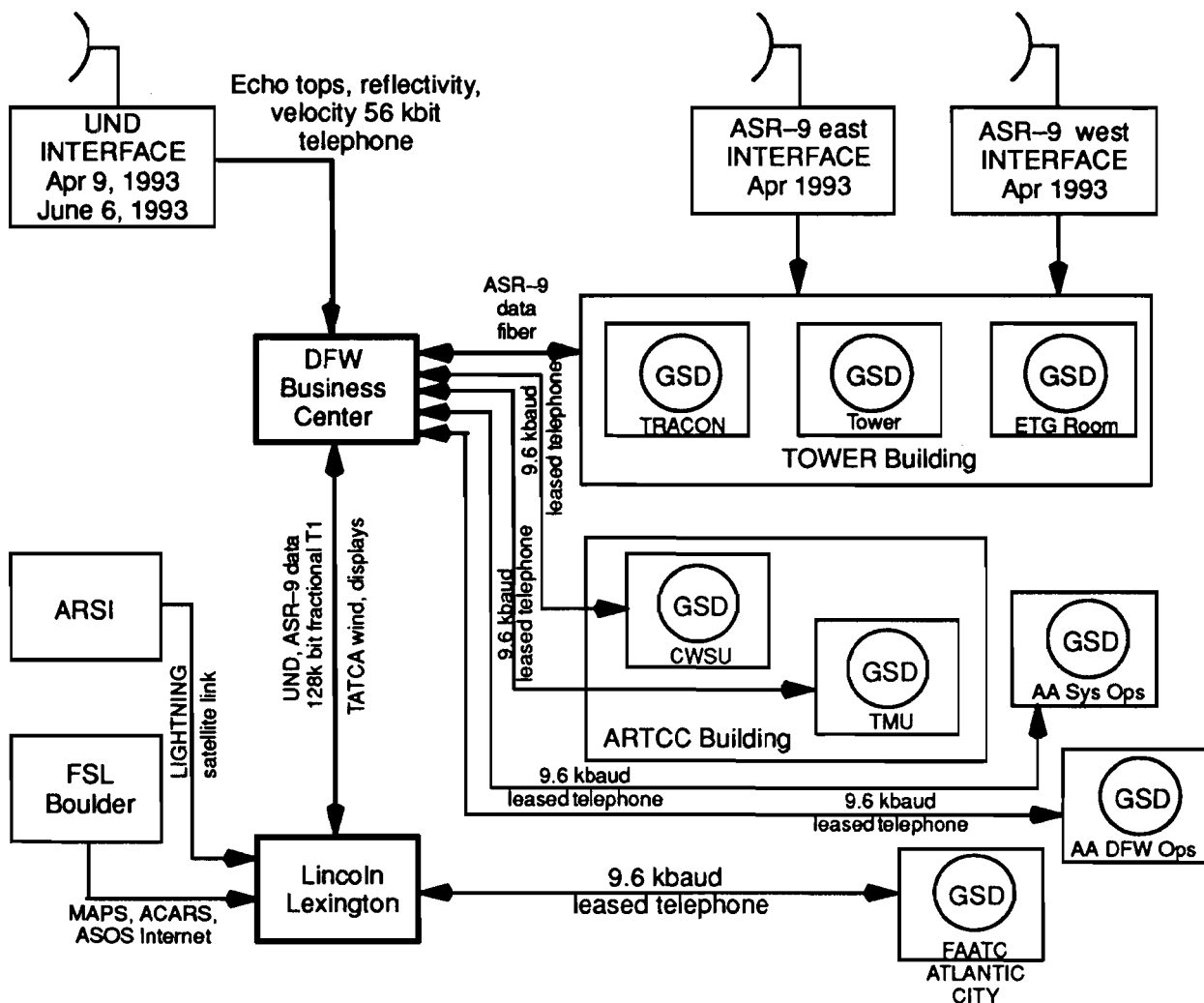

Figure 30. Dallas-Ft. Worth ITWS testbed for summer 1993.

5. PRODUCT OPERATIONAL ASSESSMENT

5.1. OPERATIONAL EVALUATION OF HIGH-RESOLUTION LIGHTING DATA AT UNITED AIRLINES GROUND OPERATIONS CENTER IN ORLANDO, FL

5.1.1. Background

Owing to the frequency of thunderstorm activity in Central Florida, lightning strikes during ground servicing operations at MCO pose a significant hazard to airline personnel. As a result of a number of deaths and serious injuries caused by ground strikes during baggage handling or refueling operations, such operations are now suspended when lightning is expected within 5 nmi of the airport terminal. To determine when this condition exists, the airport authority awarded a contract to a commercial vendor to provide a warning service based on data from the National Cloud-to-Ground network.

5.1.2. FY92 Accomplishments

Discussions with personnel from United Airlines (UA) at MCO suggested that the performance of this warning system was not always satisfactory; warnings were generated when no thunderstorms were in the area and, conversely, lightning storms near the airport sometimes went undetected. It is possible that these deficiencies reflect the coarse locational accuracy of the National CG Network (reported errors in the Central Florida area are roughly 10 km RMS [8]) and its inability to detect the intracloud activity that is a precursor to the first ground strikes. To explore the benefit associated with a high-resolution total (IC and CG) lightning mapping system, arrangements were made to provide a real-time display of weather radar and lightning data in the UA ground operations center at MCO. This was developed after the ONERA group arrived in mid-July, and the display was set up at UA during the last three weeks of August.

Figure 31 shows an example of the display during a period of thunderstorm activity near MCO. The display was a slightly modified version of the GSD provided to Air Traffic Controllers by the TDWR and ASR-9 Wind Shear Processor prototypes operated at MCO. Shown are locations of thunderstorm cells, their movement (5 kts towards the northeast in this case), and low-altitude wind shear (in the example, a gust front inbound towards MCO). For each precipitation cell identified by the radar, the number of lightning flashes detected by the ONERA system during the last minute was indicated as "L: Rate." In this example, very electrically active cells (11 and 36 flashes per minute, respectively) were drifting north of the airport; weaker cells with lower flash rates were approaching from the southwest. The yellow "lightning warning" panel in the upper right indicates that lightning radiation sources were detected within 5 nmi of the airport during the last five minutes, indicating a current hazard to ground operations.

Feedback from personnel at UA was enthusiastic. They stated that the lightning data provided by this special display was much more accurate than that obtained with the existing warning system and that it allowed them to contain down time to only the periods when an actual hazard existed. During visits to the operations center, there was considerable interest in the display, both from ground operations personnel and from outbound UA pilots, who

used the radar and lightning data for an evaluation of the weather situation around the airport prior to boarding their aircraft. Pilots often called back during taxi out to receive an update on the display.

Weaknesses of the evaluation were its short duration (the lightning mapping system was dismantled at the end of August to be returned to France), the involvement of only one airline at MCO, and the lack of a quantitative assessment of the benefits to UA operations provided by the high-resolution lightning data.

5.1.3. FY93 Plans and Issues

Efforts are underway to arrange for a follow-on evaluation this summer involving more airlines, a longer operating period, and formal feedback on the estimated benefits provided by the information.

5.2. PRODUCTS AT CWSU/TMU

5.2.1. Background

The ITWS products will improve decision making between the Traffic Management Units (TMUs) and Center Weather Service Unit (CWSU) meteorologists at the FAA en route centers and the terminal Traffic Management Coordinators (TMC) regarding traffic flows into and out of the terminal area. The ITWS product requirements for the TMU/CWSU to achieve improved decision making need to be refined. It may be appropriate to provide the CWSU with "raw" terminal weather information (e.g., the TDWR gridded velocity and reflectivity products) to facilitate CWSU short-term forecasts of weather phenomena that may impact the traffic flows. An FAA/NWS Southern Region joint program to assess the TMU/CWSU user needs and the potential advantage of terminal weather data for improved CWSU forecasting was carried out at the Jacksonville air route traffic control center (ARTCC) during the summer of 1992.

5.2.2. Observer Results

A two-month joint FAA/NWS program was conducted between the NWS forecast office in Melbourne, FL and the ZJX CWSU to assess the potential utility of ITWS short-term forecasts of convective activity (a phase 2 ITWS product) and to increase NWS Southern Region radar meteorologists' familiarity with the use of Doppler data for forecasting. An individual from an NWS facility was detailed to the Melbourne WSO for a three-week period to create short-term forecasts of convective activity based on TDWR gridded velocity and reflectivity and the corresponding NEXRAD data. The predicted regions of activity were indicated by polygons and text on a computer workstation and transferred to the CWSU along with the gridded TDWR reflectivity and velocity data to assess the product utility for Orlando traffic flow management.

During the period of 10-24 August 1992, Lincoln personnel spent time as observers at the Jacksonville, FL (ZJX) ARTCC. There were three primary purposes to this study:

1. To assist both the TMU and NWS in interpreting Lincoln's base products display of FL-2 Doppler-Radar data,

2. To observe how the NWS and TMU react to various weather scenarios, and
3. To quantify the weather delays and estimate the benefits of better forecasts and products through ITWS.

In support of this study, output from the TDWR at Orlando was sent to the NWS office at Melbourne, FL where a meteorologist monitored the TDWR and, in conjunction with other information available at the weather service office (such as NEXRAD radar information), outlined areas of potential weather impact on the TDWR image. This simulated ITWS product was then forwarded to the CWSU at ZJX.

The observer program in Jacksonville was, overall, highly informative, although some difficulties did arise. It is now more clearly understood not only how the TMU and CWSU operate individually but also how the two work together to interpret and use weather information. Conclusions and results from this study can be broken into three categories of issues: Traffic Management, Delay and Product Display.

The product display was used by the CWSU on a daily basis and by the TMU when weather impacted MCO. The most useful products for the TMU were the six-level weather depiction and the storm track vectors, while the NWS utilized these products and the velocity data to define sea breeze and gust front convergence. All agreed that a longer range scan of the reflectivity would be more useful than the 50 nmi coverage radius provided on a TDWR GSD. On at least two occasions during the observation period, the TMU moved traffic based on the storm track vectors of cells which were impacting or were about to impact air routes.

Perhaps the most successful day for the observation and display program was on 17 August. The TDWR data on that day indicated that the sea breeze front moving in from the east would encounter a weak gust front over MCO, initiating convective activity over the airport. Based on this information, the CWSU briefed the TMU that Orlando would likely be impacted with severe weather within 30 minutes. The TMU, while not changing their current vectoring of aircraft, formulated a contingency plan if MCO was shut down. The contingency plan involved negotiating holding areas for existing airborne traffic. Fifteen minutes after the CWSU briefing, MCO was shut down and the TMU's contingency plan went into effect, handling the existing traffic without incident.

In addition to assisting the CWSU-TMU, Lincoln personnel were able to learn a great deal about the internal workings of the TMU. From air routes to restricted areas, the TMU was extremely helpful in explaining not only what they were doing but why they were doing it. The observers will be able to use this information to assist Lincoln in understating how the air traffic system works and how weather impacts both TMU workload and aircraft delay.

5.3. FY93 PLANS

The principal objective of the 1993 ITWS product operational demonstrations is to lay the groundwork for a successful operational demonstration scheduled for DFW by obtaining feedback from operational users on as many of the IOC products as possible. Ideally, this would be accomplished at DFW. However, the lack of TDWR and NEXRAD data at DFW will necessitate using Orlando for the bulk of the testing. Tables 2 and 3 summarize the products to be tested in Orlando and Dallas-Ft. Worth, respectively.

At MCO, products that have demonstrated adequate technical performance will be evaluated starting 1 July 1993. Certain products (e.g., microburst prediction) that have not been tested extensively off line will be tested in real time but will not be provided to operational users until adequate technical performance is achieved. Graphical ITWS displays will be provided at the MCO tower, TRACON, and TMC; to the ZJX TMU; and to United Airlines and Northwest Airlines. A display of the gridded winds will be provided to the Melbourne Weather Service Office (WSO) to determine the utility of this information for terminal area forecasting (e.g., of new storm growth).

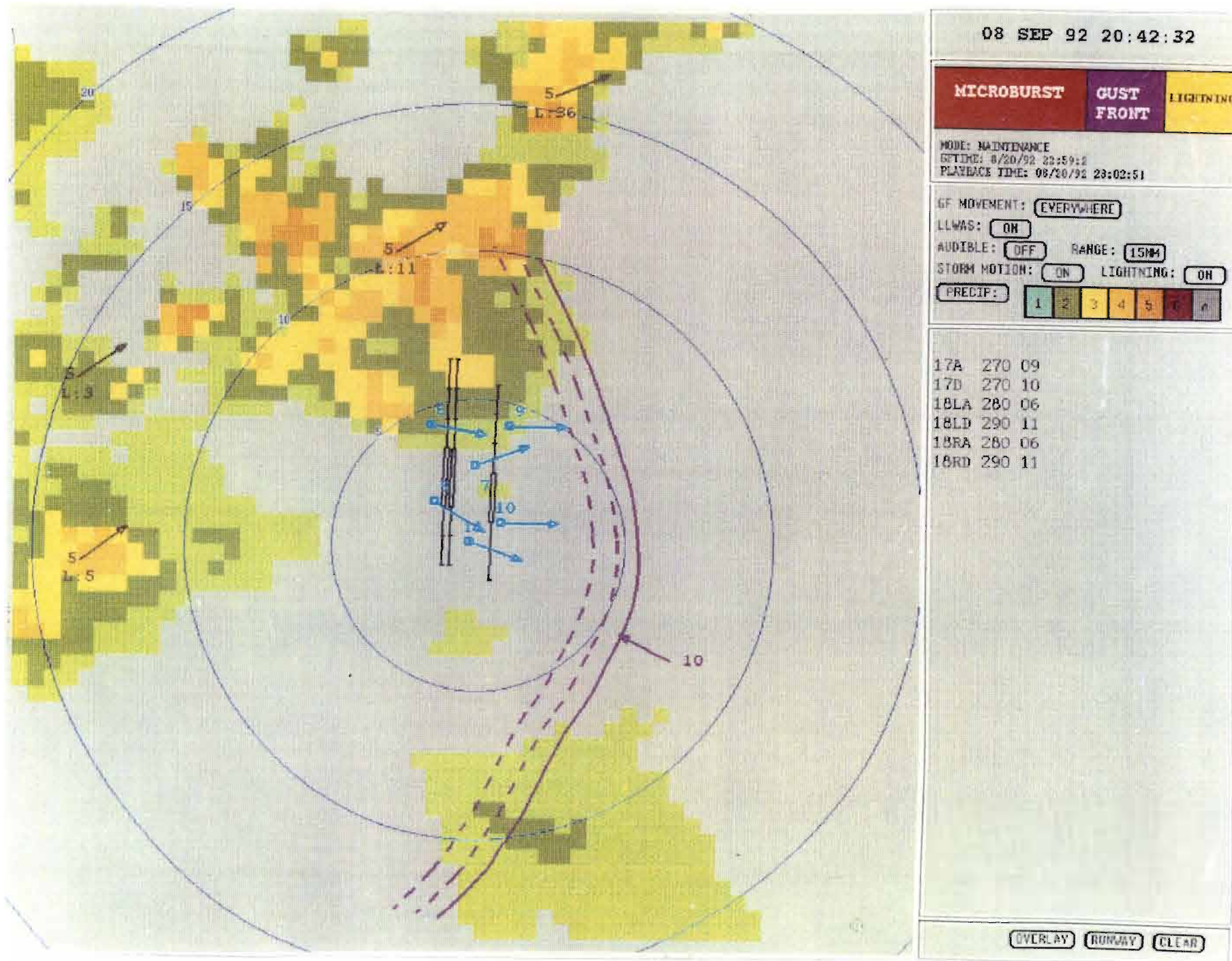

Figure 31. Weather radar and lightning display provided to United Airlines Ground Operations Center at MCO.

**Table 2
1993 Orlando ITWS Demonstration Products**

Product	Users	Comments
Microburst detection pilot product	Supervisors, pilots	Derived from TDWR product
Microburst prediction	Supervisors, traffic managers	Tentative
Hazardous cell identification	Supervisors, pilots	Hail and/or level 5 cells
Echo tops	Supervisors, traffic managers	Requested by MCO
Storm reflectivity	Supervisors, traffic managers, pilots	Uses ASR-9 weather channel
AP-edited weather channel reflectivity	Supervisors	
Storm motion	Supervisors, traffic managers, pilots	Uses ASR-9 weather channel
Storm extrapolated contours	Supervisors, traffic managers	Requested by MCO
Long-range reflectivity	Traffic managers	Requested by ZJX TMU, candidate AWPG product
Cells with lightning	Supervisors, pilots	Contingent on sensor availability
Gridded winds	Melbourne WSO	Assessment of utility for terminal forecasting
<p>The TDWR, microburst, and gust front/wind shift products will be provided with the ITWS products. Pilot information provided via ACARS data link. The ITWS microburst detection and trend products will be displayed in real time at the ITWS testbed but will not be provided to operational ATC users at MCO.</p>		

**Table 3
1993 Dallas-Ft. Worth Demonstration Products**

Product	Users	Comments
Storm reflectivity	Supervisors, traffic managers	ASR-9 weather channel
AP edited storm reflectivity	Supervisors, traffic managers	Based on storm features aloft
Echo tops	Supervisors, traffic managers	From UND radar
Storm motion	Supervisors, traffic managers	Based on ASR-9

6. TECHNOLOGY TRANSFER

6.1. SPECIFICATION

The Algorithm Specification Document is the traditional vehicle for conveying descriptions of scientific algorithms to software contractors. Requirements for this document are that it be understandable, complete, unambiguous, and testable. A contrary requirement is that it should not be so specific that it unduly constrains software design. This specification is used to convey algorithm content to contractors and to evaluate whether their software satisfies contractual requirements. There are several difficulties with the use of formal algorithm specifications:

1. The documentation requirements are vague and possibly conflicting,
2. It is difficult to determine when an algorithm specification is correct and complete, and
3. It is difficult to determine when an algorithm implementation is correct.

On the other hand, this approach has been used with reasonable success (and some difficulty) for the development of both the NEXRAD and TDWR algorithms. It has the benefit of being the principal technique that has been used successfully for the exchange of meteorological algorithms.

As a response to the difficulties with the specification process, alternatives are being investigated. Some of these involve radical departures, which have significant anticipated advantages and unforeseen pitfalls of their own. There is less risk in amending a process, which has served its purpose, to deal with specific problems that have been identified through experience. It is clear from our previous experience that algorithm specification by this method will be a difficult and expensive task. Specification short-cuts that do not compel correct algorithm software development will have their own expense as contractual performance is evaluated.

Several shortcomings of the algorithm enunciation language (AEL), which was used for NEXRAD and TDWR, have been identified by the algorithm developers and the contractors. There are parts of the AEL that are too restrictive (e.g., no vehicle for submodules or subroutines) and there are some blatant omissions (e.g., input and output lists). In addition, the AEL methodology does not directly serve the needs of the 2167A software development requirements. These years have been a learning experience, and it was decided to develop an improvement of the AEL.

The approach is to provide the algorithm developer with a high-level template of a specification document with fairly complete instructions regarding the contents of the component parts. The requirements for meta-code style are lax. This is the primary area in which it is very difficult to obtain a consensus, and we did not feel that any one style has intrinsic advantages over any other. Several of the algorithm developers with NEXRAD and TDWR AEL experience have contributed to the content of this document. It is viewed as a living document, but we feel that it is a good benchmark of the current state of knowledge regarding this approach to algorithm specification. It is a specification for algorithm specifications, and is usually referred to as the "Spec" Spec.

The Spec Spec is complete, except for the test section, and has been used internally for the specification of a couple of small algorithms. Since alternative approaches to algorithm specification are being considered, no further development of the Spec Spec is intended at this time. If it were decided that this is a method that will be used for ITWS algorithm specifications, then the test section can be completed in two to three months.

6.2. CASE TOOLS/C++

The Software Through Pictures (StP) CASE tool, a product of IDE, was purchased and used in the design of the microburst detection and trend algorithms. The product was chosen because it offers an automated means of documenting the software design process, either using the 2167A standard or a user-defined format. The product is composed of several distinct editors which include the data flow editor, control specification editor, data structure editor, transition diagram editor, and state transition editor. The StP Tool was used to design the microburst detection and trend algorithms, with particular emphasis given to the understanding of the essential algorithm processes and both their external and internal interfaces.

An example of the data flow diagrams for the microburst detection and trend algorithm (LAMDA) are shown in Figure 32 which, in part (a), depict the top level and the external interfaces, while Figure 32(b) shows a more detailed level. Every data flow and process name can be annotated with text descriptions, data types, pseudo-code and code. With appropriate data structure definitions, code generation (C, FORTRAN) is possible.

Our experience indicates that the StP program has some promising features, including strict version control of diagrams and documentation and automated document generation. Users of the package quickly became aware of the more tedious aspects of diagram entry (often due to slow execution speed on our system). More important to many developers is the inability of StP to incorporate the concepts of object-oriented languages such as C++. This makes it difficult for the tool to simultaneously be useful as a technology transfer tool and as internal code documentation. Another IDE product, the object-oriented software design/C++ (OOSD/C++) tool, was evaluated and is considered promising for this purpose when reverse engineering facilities are mature.

The microburst detection and trend algorithms became the first product prototypes to be created in C++. The C++ language was chosen because of its object-oriented properties which can improve the reusability of code while inheriting the transportability of and compatibility with C code. This next year will be helpful in assessing the impact of C++ as real-time algorithms are operationally tested and maintainability is examined.

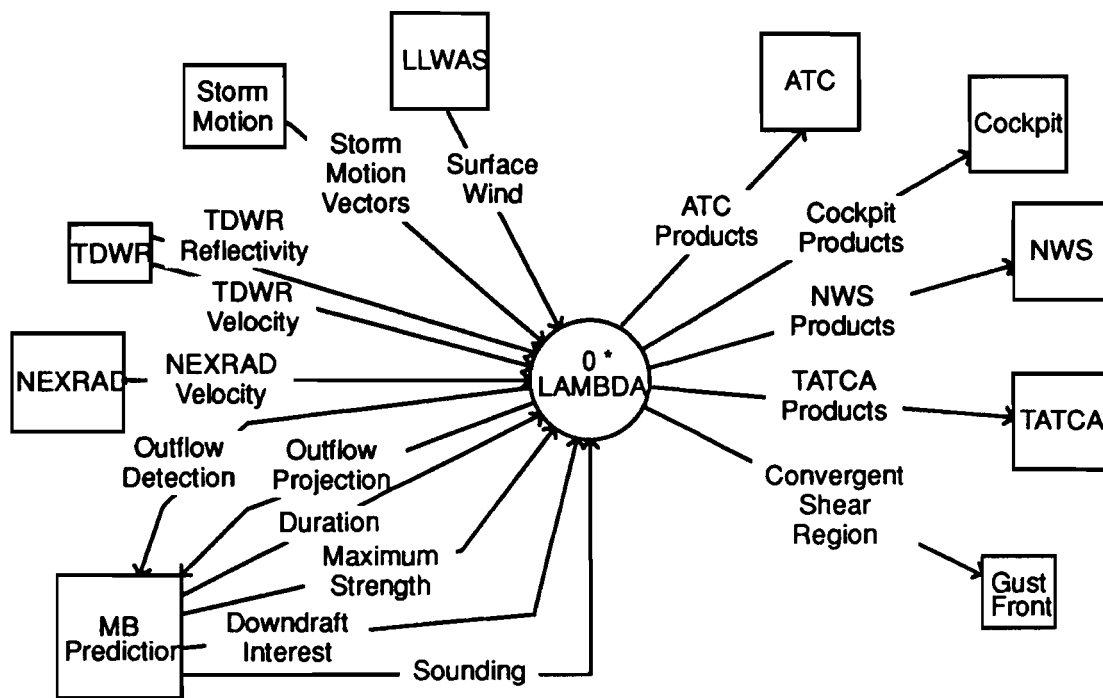

(a)

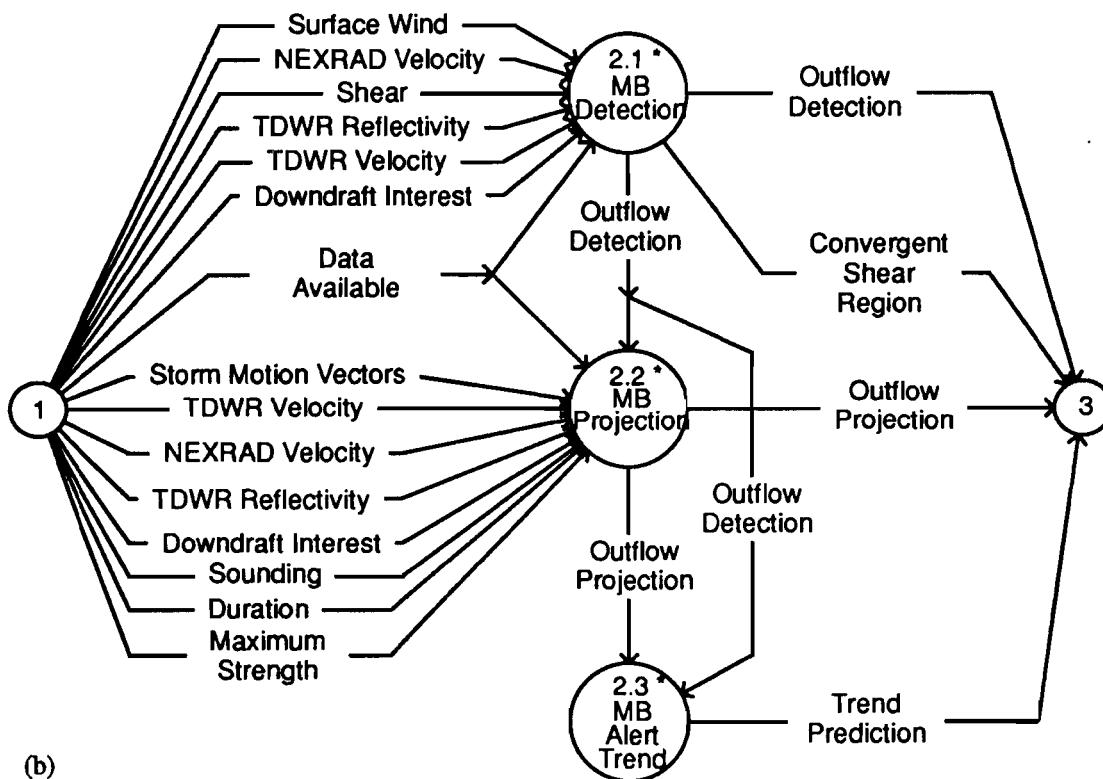

(b)

Figure 32. Sample diagram from the StP CASE tool.

6.3. PLANS FOR HAMILTON

One of the difficult challenges in technology transfer for systems such as ITWS has been the verification of the algorithm specifications. In the case of the TDWR and NEXRAD systems, product generation software was in some cases coded four times:

1. Initial development software,
2. Research organization real-time code for operational demonstrations,
3. Generation of a specification from 1. and 2. above,
4. Coding from the specification to verify specification accuracy (by a group not associated with algorithm development), and
5. Coding by the production contractor.

One option for improved efficiency is to write the prototype code in 2. from the production specification, thus reducing the need for step 4. (as discussed in Section 6.2.)

A software engineering system from Hamilton Associates, (Cambridge, MA) may offer additional options for further facilitating technology transfer. Hamilton has developed a high-level algorithm specification language which can be translated into:

1. An English statement of the algorithm, and
2. C language or ADA-executable code.

Preliminary discussions were held with Hamilton Associates on the characteristics of their system. It is anticipated that the ITWS program may be used as a pilot program for this tool as part of an overall FAA initiative at improved technology transfer.

7. PILOT DATA LINK

7.1. BACKGROUND

Recent weather-related programs sponsored by the FAA and NWS will dramatically increase the quantity and quality of weather information available to ground-based users. However, there is an equally pressing need to provide improved weather information to flight crews via data link. The recent advent of the aeronautical telecommunications network (ATN) raises the prospect of a unified umbrella under which ground-based weather information will be provided via an array of data link services (e.g., Mode S, satellites, VHF radio).

Providing weather information directly to pilots via data link will also have the important benefit of decreasing controller workload. Currently, much of the weather information provided to pilots in flight is delivered verbally by controllers. Eliminating this element of controller workload would lead to an increase in productivity and potential savings to the government.

The thrust of the ITWS Pilot Information task is two-fold, with near-term and long-term components. The near-term component places emphasis on generating textual products to be transmitted using existing aircraft data link capabilities such as ACARS. The long-term component places emphasis on generating graphical products to be transmitted using advanced data link services (e.g., Mode S, high-speed VHF radio, satcomm). The main technical challenge in either case is to adapt the proposed ITWS products to a form which is appropriate for cockpit display, given crew needs.

7.1.1. FY92 Accomplishments

In view of the above considerations, a pilot information task, which consisted of three subtasks, was added to the WBS. The first subtask involves the development of text-based terminal weather messages to be transmitted via ACARS to commercial air carrier aircraft. Work began on a demonstration to be carried out using the ITWS testbed at Orlando during the summer of 1993. This service would be provided in conjunction with the Digital ATIS program currently being implemented by ARINC.

An overview of the implementation approach is shown in Figure 33. When an aircraft downlinks a Digital ATIS request, the request is routed through the tower data link system (TDLS) to a database located at the ARINC headquarters at Annapolis, MD. This database contains the surface observation (SAO) and other relevant information (e.g., runway usage, migratory bird warnings, etc.) to generate the ATIS message. The appropriate ATIS message is retrieved from the database and sent to the aircraft.

Having made the digital ATIS request, the aircraft is now eligible to receive terminal weather messages generated by the ITWS testbed at Orlando. The testbed will generate these messages and transmit them to a database similar to that maintained for Digital ATIS. When the ITWS testbed detects a significant change in airport weather conditions, it will generate an update to the database. This update will cause a new terminal weather information message to be sent to the eligible aircraft. In order to prevent excessive pilot workload, thresholds will be established to prevent updates from happening more frequently than about once every five minutes. There also will be time outs to prevent messages from being sent after about 20 minutes from the initial Digital ATIS request.

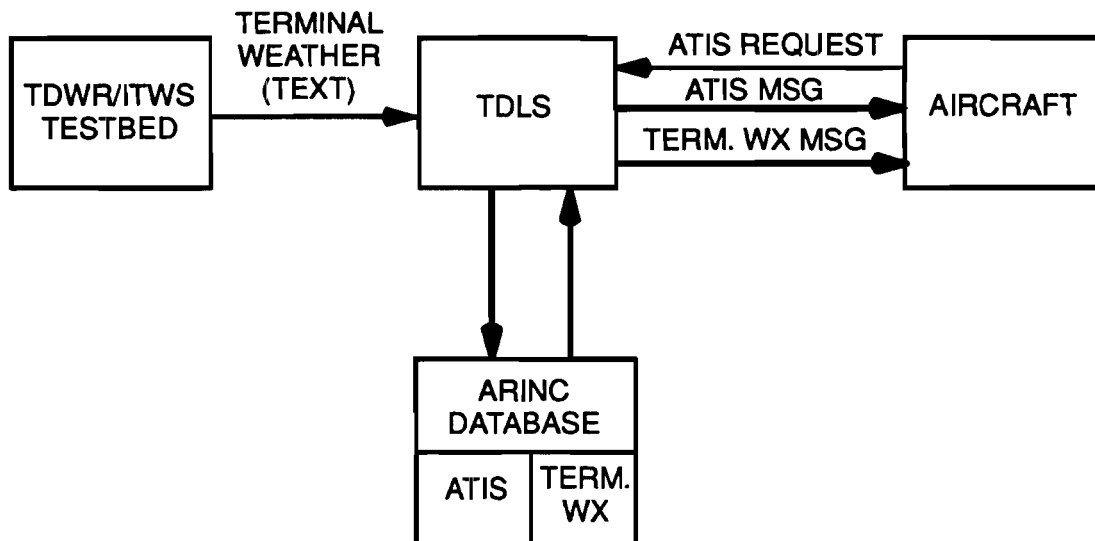

- **ADVANTAGES**

- UTILIZES ORLANDO TDWR TESTBED
- POSSIBLY FOUR AIRLINES WITH GOOD ACARS EQUIPAGE USE MCO
- SIMPLE EXTENSION TO DIGITAL ATIS (OPERATIONAL BY SPRING 1993)
- ITWS PROGRAM WILL SUPPORT LINCOLN WORK

Figure 33. Orlando ACARS demonstration.

A preliminary version of the terminal weather message service concept was developed during FY92, and discussions were held with ARINC on the feasibility of a demonstration in the summer of 1993. The positive results of these discussions led to plans for exploratory talks with the Airline Pilot's Association (ALPA) Aviation Weather committee and representatives of airlines flying into Orlando. The concept also was briefed to the SAE S7 (Flight Handling and Cockpit Displays) committee meeting at Atlanta, GA in late September 1992.

With regard to the longer-term objective of providing graphical terminal weather products in the cockpit, discussions were held with the Air Traffic Surveillance group at Lincoln concerning demonstrations of providing graphical products via Mode S data link. A commercial provider of graphical weather products via narrow-band television transmitted as a subcarrier on FM radio stations also was approached on this subject. Initial discussions indicated that demonstrations might be feasible in FY93.

7.1.2. FY93 Plans and Issues

The main focus of FY93 activities will be the demonstration of providing text-based terminal weather messages via ACARS. It is planned to provide this service for the period 7 July through 31 September at Orlando as a cooperative effort between Lincoln and ARINC. Initial work will concentrate on briefing the concept to pilots and airlines into obtain feedback on the operational concept and the proposed message content. Once a consensus on these issues is obtained, the concept will be implemented and the demonstration will be car-

ried out (note: implementation of the ARINC portion of the project is contingent on obtaining FAA funding).

Prior to the demonstration, the airlines will be provided with training material that can be given to their air crews. During the demonstration, there will be an effort to obtain feedback from crews in the form of questionnaires. The results of the demonstration will be evaluated and conclusions drawn about the utility of the service and potential areas of improvement

Finally, Lincoln will seek additional opportunities to demonstrate the transmission of graphical products to aircraft for cockpit display. These opportunities will be pursued with the Air Traffic Surveillance group at Lincoln, airlines, and commercial vendors. Investigation will be undertaken into the feasibility of establishing cooperative research and development agreements (CRDAs) with such commercial vendors.

8. TECHNICAL SUPPORT

The ITWS program is being conducted under guidelines issued by the Office of Management and Budget (OMB) circular A-109 which describes the steps associated with a major system acquisition. One of the key milestones in the A-109 process is a series of Key Decision Points (KDPs). The ITWS KDP-2 was scheduled for the winter of 1992. Lincoln provided technical support for the generation of a number of documents which are a part of the overall data package for KDP-2.

8.1. ALTERNATIVE ANALYSIS

8.1.1. Background

The alternatives analysis is a required part of the A-109 acquisition process. It attempts to identify candidate system implementation alternatives, at least one of which will be considered sufficiently viable that it could be carried forward into field testing. To some extent then, the alternatives analysis influences the (development of) the functional prototype, although the extent of the influence is yet to be determined.

The analysis effort was led by Martin Marietta, with Lincoln providing technical expertise.

8.1.2. FY92 Accomplishments

Initial (candidate) alternatives were identified and evaluated. Some alternatives were eliminated based on obvious technical or programmatic limitations. The remaining alternatives were cross-compared by Martin Marietta using the Analytic Hierarchy Process. This involved cost, schedule, programmatic, and technical criteria, with both Lincoln and Martin Marietta contributing to qualitative pair-wise comparisons of alternatives.

Particular technical inputs supplied by Lincoln in support of the alternatives analysis (as well as the independently performed cost-benefit study) included estimates of computation requirements, input/output bus bandwidths, processor upgrade potential, and sizing of algorithmic software.

Lincoln reviewed the final alternatives analysis document, which was authored by Martin Marietta. The analysis clearly favored incorporating ITWS in TDWR, at least to the extent that TDWR would provide communications, a remote maintenance monitoring system (RMMS), operating environment, interim Tower/TRACON displays, and at most sites, half of the wideband radar data needed.

8.1.3. FY93 Plans and Issues

No further work is planned, although an occasional review of the assumptions and qualitative comparisons made during the alternatives analysis is anticipated.

8.2. FUNCTIONAL REQUIREMENTS

8.2.1. Background

The specification of the functional requirements for the ITWS, including product technical performance, is a required part of the A-109 acquisition process. The functional re-

quirements for the ITWS should be similar to those for related terminal weather information systems (e.g., the TDWR) in terms of functional characteristics, data source characteristics and the operational use of the products. ITWS product testing (technical and operational) is an important element of the functional requirements definition process.

The preparation effort for the functional requirements was led by Martin Marietta based on technical input provided by Lincoln Laboratory.

8.2.2. FY92 Accomplishments

The Lincoln developers for the various ITWS products prepared initial functional requirements for the ITWS products based on the product usage concepts described in the operational concept and on a nominal terminal sensor configuration, including at least one of the following:

- TDWR
- NEXRAD (within 40 km of airport)
- ASR-9 (not equipped with wind shear processor)
- Enhanced LLWAS
- ASOS/AWOS
- ACARS
- AGFS

These product requirements specifications were reviewed internally and then transmitted to Martin Marietta.

A number of problems were highlighted in this process:

1. Simulations of the effects of wind field errors on the Center-TRACON Advisory System (CTAS) traffic management system performance need to be carried out by the CTAS developers using realistic wind error models provided by ITWS product developers.

Simple flight time analyses were carried out for dependent (i.e., highly correlated) wind errors and for independent grid point wind errors. These suggest that highly correlated errors can easily yield separation errors which could adversely affect system performance (e.g., 2 m/s error on each of two spatially separate tracks which merge after 15 minutes of flight could produce a spacing error of 2 nmi for a nominal 3 nmi spacing), whereas large amplitude, uncorrelated errors which vary rapidly spatially can be readily tolerated.

However, the actual CTAS is believed to have a degree of closed loop control which will change. Additionally, actual merging flight tracks and realistic correlated wind errors need to be considered.

2. The requirements for a number of the ITWS planning tools need to be refined through operational demonstration and testing. There are

major changes occurring in the practice of terminal air traffic management with the addition of the traffic management coordinators (TMC), staff who will, on a full-time basis, plan terminal route usage and coordinate with the en route traffic management units. Consequently, past experience in which supervisors intermittently accomplished route planning on a time-available basis, does not provide a good basis for developing the quantitative requirements for products such as weather-impacted airspace, storm motion, etc.

3. Requirements for safety enhancement products such as microburst location, trend and prediction may be affected significantly by the use (or non-use) of the Mode-S data link. The possible controller workload associated with providing improved wind shear warnings is an important consideration. However, if the Mode-S system can provide timely aircraft position tailored warnings, overall safety as characterized by pilot response to warnings would be significantly improved [9].

The TDWR/LLWAS users' group experience suggests that input from an ITWS users' group will be very helpful in addressing issues such as these.

8.2.3. FY93 Plans

The ITWS functional requirements will be updated based on the following:

1. Operational demonstrations at Dallas-Fort Worth and Orlando,
2. ITWS users' input,
3. The needs of automation systems (e.g., CTAS),
4. Cost/benefits analyses, and
5. Results of technical testing for the IOC products.

The Air Traffic Weather Requirements Team will release its report on the Air Traffic Service weather information needs shortly, and it is expected that a similar expression of needs will be developed by the Flight Standards Service. Meetings with an ITWS users' group also will assist in clarifying some of the issues discussed above. Visits will be made to major FAA airports with substantial weather impacts (e.g., SFO, ATL) to better understand the quantitative capability needed to meet their needs.

8.3. OPERATIONAL CONCEPT

8.3.1. Background

A description of the operational concept for a system is a required part of the A-109 acquisition process. It attempts to describe how the system will be used in the ATC system, including any changes in the responsibilities of various personnel such as controllers and pilots.

The principal responsibility for drafting the operational concept document for the KDP-2 was assigned to the MITRE Corporation, with Lincoln providing substantive suggestions on the overall concept.

8.3.2. FY92 Accomplishments

The initial emphasis for the ITWS operational concept developed by the FAA System Engineering service was that of reducing terminal controller and supervisor workload and space problems by combining various terminal weather information products that would have been displayed on different displays into a single integrated display which did not require controllers to interpret meteorological data or resolve conflicting data. Although this is a useful capability of the ITWS system, we determined the following:

1. There are major changes in the practice of terminal ATC that will be occurring in the near future as a consequence of other developments that require a significantly different emphasis for the overall ITWS operational concept, and
2. The ITWS operational concept needs better emphasis on the quantitative benefits that are being identified in the cost–benefit study.

One of the key challenges in addressing issue (1) was to determine an appropriate framework for discussing the issues associated with near–term changes in terminal ATC. A useful framework for discussing substantive changes in the way that an organization functions has appeared recently in the business/organizational theory as “paradigm shifts.” For purposes of the present discussion, a paradigm is a set of rules and regulations (written or unwritten) that (1) establish or define boundaries and (2) tell you how to behave inside those boundaries in order to be successful. A “paradigm shift” is a change to a new game, a new set of rules.¹

Consider three major terminal air traffic paradigm shifts currently underway and how ITWS fits into these shifts.

Paradigm Shift #1: Short–Term Route Planning in the Terminal Area as an Outgrowth of Traffic Automation

Currently, the attention to short–term planning for routes in the terminal area is fragmented by the other responsibilities of the terminal supervisors, difficulties in accomplishing contingency analyses, and the lack of convenient mechanisms for distributing a plan to the various controllers. As a result, individual controllers working with pilots make and execute very short–term plans to address the current weather situation.

The TATCA Center TRACON Advisory System (CTAS) offers the possibility of improving the capacity of a given airport while at the same time decreasing controller workload by providing a user–friendly means to generate an optimized terminal traffic plan and disseminate it to the controllers. Since CTAS offers the potential for having all terminal controllers achieve the same performance as the very best controllers, even on difficult problems such as sequencing, merging and identifying future aircraft conflicts, the Air Traffic Service has been strongly encouraging its implementation.

1. These definitions are drawn from the book, *Future Edge: Discovering the New Paradigms of Success*, by Joel Barker (Morrow and Company, 1992).

What has not been fully appreciated is the role of short-term planning if successful CTAS operation is to be achieved. With CTAS, the terminal area has for the first time a traffic manager whose sole responsibility is to perform a traffic management function. Options for future traffic flow are analyzed by the CTAS, with the plan chosen by the planner being automatically distributed to the controllers. An important element of this planner responsibility will be to consider the potential effects of weather (such as wind shifts) that may necessitate a runway change at some time in the future and develop a time-dependent plan which minimizes the impact of the weather.

The CTAS cannot respond effectively if there is a series of short-lived traffic flow changes made at the last moment. Consequently, it is essential that the CTAS traffic planner have reliable information on weather changes impacting the runways and routes in the terminal area on a time scale compatible with the controllability of the traffic flow (i.e., times on the order of 10–15 minutes). A key element of ITWS is providing this very short-term anticipation of changes in terminal routes and runways.

**Paradigm Shift #2: Short-Term Route Planning in the Terminal Area
as an Outgrowth of the Use of Flight Management Systems**

The bulk of the new aircraft being procured by airlines have very capable, automated cockpits with flight management systems (FMS) that offer the potential of significant reductions in fuel consumption. This is particularly important in the terminal area since the bulk of U.S. flights have relatively short stage lengths, and time in the terminal area (especially descent) can be a significant fraction of the overall flight time.

However, as indicated by three articles from *Aviation Week & Space Technology*, [10],[11],[12] there is a major mismatch between the way that terminal ATC currently operates and the needs of the FMS-equipped aircraft. Changes in operational procedures, such as not using the FMS in the terminal area to reduce the increased pilot workload which arises with current terminal ATC methods may provide some near-term relief. However, it is clear that there will be increased pressures to have terminal ATC change its approach to be more compatible with the use of FMS in the terminal area.

Fortunately, the changes to better meet the needs of FMS-equipped aircraft are largely the same as those of terminal automation systems; namely, that route changes in the terminal area be minimized as much as possible. Here again, the thrust of ITWS to provide better short-term predictions of weather's impact on terminal routes also will meet the information needs for the FMS equipped aircraft.² Additionally, ITWS could provide gridded wind data up to FMS aircraft to enable them to further optimize their descent trajectories.

It is recognized that improved terminal weather information should be provided to pilots, and an aggressive program is underway to provide graphical information to pilots via the Mode-S data link and via other available communications links. Additionally, develop-

2. One issue here is whether ITWS should be data linking information on winds along the intended FMS path to aircraft.

**Paradigm Shift #3: Effects of Pilot Direct Access to Terminal Weather
Information on Information Provided to Terminal Controllers**

ment of airborne Doppler weather radars that can provide an expanded functionality such as wind shear detection is rapidly proceeding as a result of FAA regulatory actions.

In the interim, terminal controllers providing information over the VHF voice links have been the main mechanism for urgent communication. However, the principal responsibility for aircraft control (and the crowded automated radar terminal system (ARTS) screens) has resulted in the need to restrict the information available to terminal controllers.

For example, at the most recent TDWR/LLWAS users group meeting, it was noted that the pilots would prefer to have wind shear warnings for a runway they are intending to use provided to them prior to turning onto final approach. However, the current workload of the TRACON final controllers is such that the Air Traffic Procedures personnel present at the meeting could not support providing the requisite wind shear information (e.g., microburst alerts) to the final controllers for transmission to the pilots.

With the advent of direct data link transmission of information to pilots, this conflict between the controller responsibilities and the need to provide timely weather information to the pilots will diminish markedly. However, the need to provide a graphical depiction of the weather products to TRACON controllers may not diminish.

The traffic alert and collision avoidance system (TCAS) operational experience has shown that it is very desirable if the terminal controllers have knowledge of information provided to a pilot which may require a change in flight path. With the provision of reliable real-time information on terminal weather hazards to the cockpit (either via data link or via on-board systems), it is essential that the terminal controllers have access to the same information so they both can anticipate requests for flight path changes and participate meaningfully in a dialog with the pilots as to subsequent routing.

Consequently, we concluded that an important element of the ITWS program is to make information available to the terminal controllers to facilitate controller anticipation of actions by the pilots in response to hazardous weather warnings and to better deal with situations where flight path changes have occurred in a complex terminal area weather environment.

The use of "paradigm shifts" to explain how the safety and functionality exemplified by TDWR/LLWAS/ASR-9 must be extended to address the future terminal ATC need for weather information to support traffic planning and delay reduction was provided to the MITRE researchers and to the FAA Air Traffic Weather Requirements review team in the spring and summer of 1992. Both groups found this a useful approach for describing the ITWS functionality and for taking a more future-oriented view of the required terminal weather information system functionality. Additionally, Lincoln provided intermediate results of the ITWS benefits assessment to the MITRE researchers so that the description of the operational concept would emphasize those issues which offer the greatest quantifiable benefits.

Figure 34 shows how ITWS will support various elements of the future aviation system. In contrast to the terminal weather information system of today where time-critical information is provided on a piecemeal basis principally to the local and arrival/departure control-

ITWS

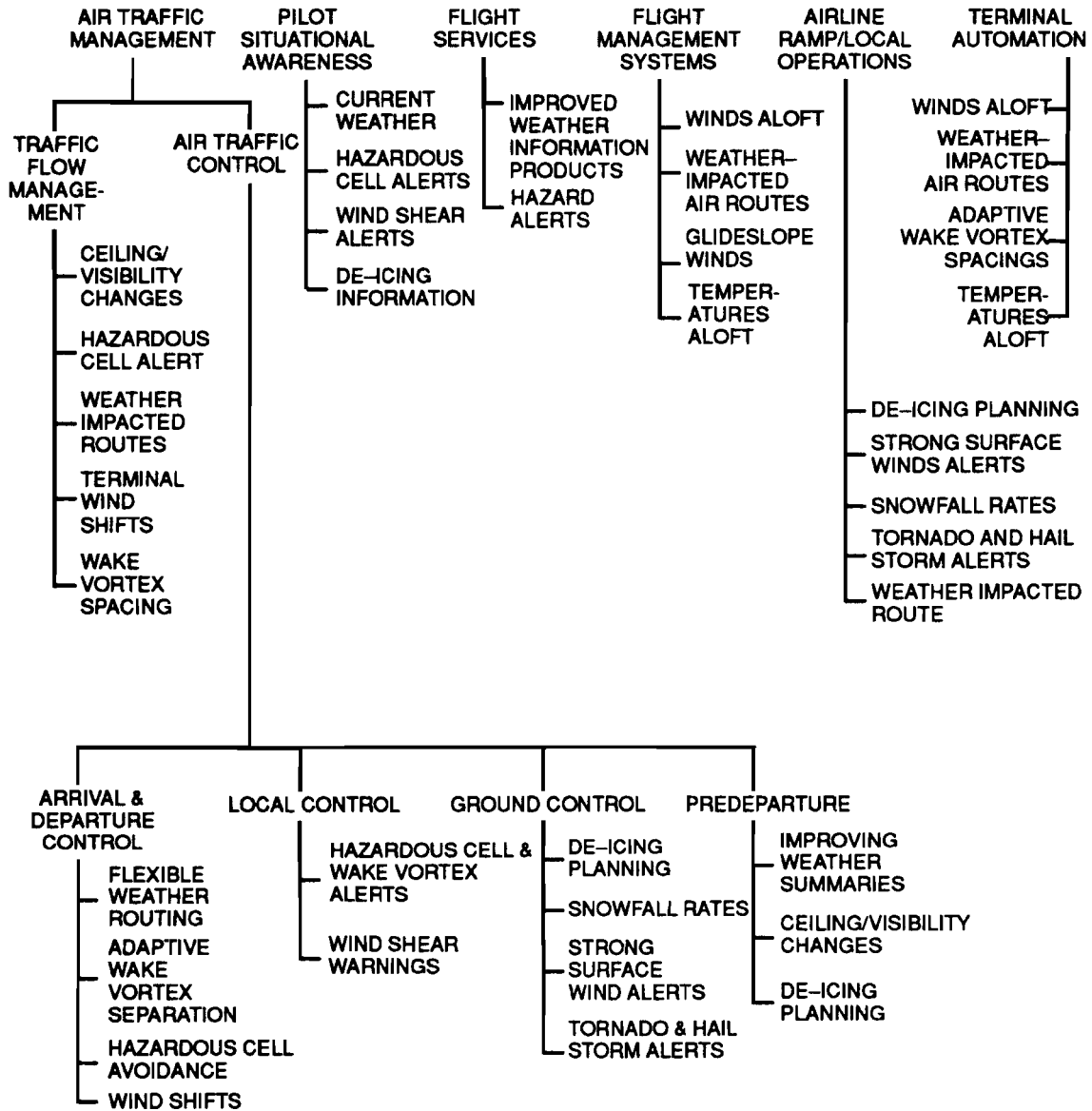

Figure 34. Terminal area operations supported by ITWS.

lers, we see a much greater emphasis on supporting automation, planning functions and direct transmission to pilots and the airlines.

Table 4 summarizes how ITWS, working in concert with the various other new terminal ATC system elements, assists in achieving major improvements in overall capability.

8.3.3. FY93 Plans

Additional refinements probably will be made to the operational concept for ITWS as a result of the FY93 testing at Orlando and Dallas–Ft. Worth.

8.4. COST/BENEFITS

Part of the technical support associated with ITWS has been an ongoing analysis of cost/benefits associated with providing improved terminal area weather information. An assessment of achievable benefits is useful for justifying continued program support as well as providing a framework for measuring achievement during system development.

Table 4
Impact of ITWS on Airspace Organization

Current Organization of Airspace	Future Organization or Airspace	ITWS Contributions
Available runway capacity not achieved due to difficulties in traffic metering and spacing. High controller workload during periods of adverse weather.	Terminal automation systems (e.g., CTAS provides metering/sequencing aids for ATC.	Gridded winds and weather impacted air route information for CTAS.
Excessive pilot workload in FMS equipped aircraft due to weather/traffic induced terminal route changes.	Changes to fuel efficient terminal routes are minimized by ability to anticipate and avoid changes due to weather and/or traffic.	Identification of air routes which are, and/or will be, adversely impacted by weather.
Low ceiling/visibility incidents result in significant loss of possible capacity due to inability by flow management to anticipate changes.	Ability to anticipate changes in ceiling and visibility minimizes periods of lost capacity.	Short term predictions of ceiling and visibility changes.
Limited ability to accommodate advanced avionics capability and different aircraft types.	Improved ATC capability to support different avionics/aircraft types.	Weather products tailored to meet the needs of different avionics/aircraft types/user capabilities.
Operations in controlled airspace restricted by minimally equipped users.	Control concept and airspace segments matched to user capabilities.	
Fixed procedures based on manual decisions.	Adaptive procedures based on automated decision aids in ATC and the cockpit.	Data on current and anticipated weather impact on procedures including wake vortex movement.

**Table 4
(Continued)
Impact of ITWS on Airspace Organization**

Current Organization of Airspace	Future Organization of Airspace	ITWS Contributions
Fixed approach/departure routes determined by NAV aids.	Flexible routing with MLS/RNAV/INS and FMS.	Weather information for converging approach merging.
Approach paths restricted by intercept of fixed glide slope along extended runway centerline. Geometry and wake vortex separations restrict capacity.	Flexible choice of approach paths for high capacity with wake vortex avoidance. ATC monitoring enhancements support curved approaches with short finals.	Winds data for approach paths and curved approach timing. Identification of hazardous approach paths.
Fixed separation requirements determined by worst-case combinations of wake vortex, ATC sensor errors, station-keeping errors, and system response times.	Reduced separation depending on aircraft pairing and wake vortex conditions. Reduced margin required for sensor errors, station keeping variance, and response times.	Wake vortex movement information for determining aircraft separations.
Critical preflight decisions (e.g., de-icing) based on fragmentary weather and traffic management information.	Reliable short-term weather and traffic information are provided to pilots and local operations in a timely manner.	Current and short-term predictions of key factors such as snowfall rate, temperature, ceiling and visibility.
Difficulties in determining hazardous cells restrict operational flexibility and capacity.	Hazardous cell detection enables safe high-capacity operations when conditions permit.	Hazardous cell detection and short-term prediction.
Adverse weather can have widespread effect on terminal area capability and airport closures/openings.	Adverse weather effects limited to local areas due to improved monitoring/predictions and system adaptability. Runway use reconfiguration employed rather than airport closure.	Highly specific identification of current and near-term weather impacted airspace regions and communication to traffic managers at all levels.

The initial work related to cost/benefits assessment was a study done as part of an effort to define weather information requirements for TATCA. For this study, the objective was to estimate the impact of weather on aviation system delays at major U.S. airports. The methodology was to derive a relationship indicating the variation of delay incurred on days during which various types of weather occurred (using clear weather days as a baseline) and apply the climatology of weather occurrences at specific airports to estimate an expected annual delay attributable to various types of weather (Figure 35). The weather/delay relationship was derived using one year of daily delay and weather data from O'Hare International Airport in Chicago. The delay data were obtained from the National Airspace Performance Recording System (NAPRS), which includes only the delays of 15 minutes or more. The daily weather data were obtained from the Local Climatological Data (LCD) summaries available

through the National Climatic Data Center. Types of weather days were separated into four

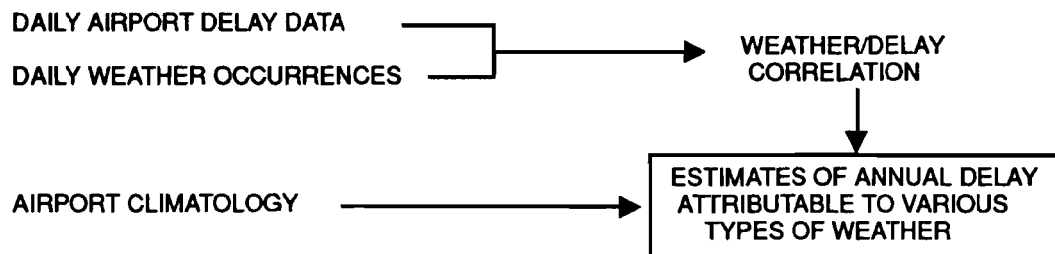

Figure 35. Methodology for estimation of annual delay at major U.S. airports attributable to weather.

categories: thunderstorm days, heavy fog (visibility 1/4 mile or less), reduced visibility days (less than seven miles but greater than 1/4 mile), and clear days. An average daily delay per operation was computed for days of each weather type, with delay in excess of the baseline delay (i.e., on clear days) attributable to each weather type. This relationship was then applied to the climatology of weather occurrences at major airports to estimate the relative contribution of weather to annual delays (Table 5). Results showed that weather is attributable to 70–90 percent of the total serious (greater than 15 minutes) delay time at major U.S. airports.

Table 5
Estimates of Annual Serious (at least 15 minutes duration)
Delay Attributable to Various Types of Weather
at Ten Most Active U.S. Airports

	– ANNUAL # OF DAYS –				– Wx DELAY MINUTES (X 1000) –				
	OPS	TH	FOG	LVIS	TH	FOG	LVIS	ALL Wx	Wx CONTRIB
CHICAGO	2175	38	16	109	405	338	853	1642	88%
ATLANTA	2156	50	30	136	588	629	1056	2272	84%
LOS ANGELES	1589	3	44	121	26	680	692	1398	86%
DALLAS	1578	45	11	86	387	169	489	1044	89%
DENVER	1438	41	10	57	321	140	295	756	91%
SAN FRANCISCO	1255	2	17	101	14	207	456	677	91%
ST. LOUIS	1178	45	11	156	289	126	662	1076	86%
BOSTON	1162	19	23	125	120	260	523	903	88%
PHOENIX	1142	23	2	5	143	22	21	186	97%
DETROIT	1137	33	22	121	204	243	495	943	87%

OPS = daily operations, TH = Thunderstorm, FOG = Heavy Fog, LVIS = Low Visibility other than heavy fog, ALL WX = all weather combined, WX CONTRIB = Percentage of total delay attributable to weather.

The initial estimate of derived benefits from improved terminal area weather information defined the current air traffic system “cost” in terms of weather-related delay, with the estimated benefit being some measurable decrease in delay. This delay decrease is dependent upon the fraction of weather delay that is avoidable and the fraction of avoidable delay reduction that is achievable:

$$\text{ESTIMATED BENEFIT} = \text{CURRENT DELAY} \times \left(\frac{\text{POTENTIAL IMPROVEMENT FACTOR}}{\text{ACHIEVABLE IMPROVEMENT}} \right)$$

Since the weather-related delay estimate was taken from the TATCA weather/delay study, attempts have been made to refine the total delay estimate to account for known deficiencies in the raw delay statistics. One significant deficiency is that the NAPRS delay data do not consider ground delays at originating airports due to weather at destination airports. Thus, the NAPRS data indicate the outbound (departure) delay outweighed the inbound (arrival) delay by nearly a factor of two to three. Since a major component of ITWS may be a reduction in this unaccounted ground delay, an attempt was made to estimate its magnitude through analysis of delay data provided by commercial airlines.

Both American Airlines and United Airlines were given a list of days for which O’Hare airport was impacted by fog or thunderstorms. They were chosen to include days when the weather impact was limited to the Midwest area in order to isolate the effect of the weather at O’Hare. Both airlines provided Lincoln with their delay statistics for those weather days (plus a baseline clear day), including gate hold delay at originating airports. Although there were some inconsistencies in the airline data, both sets of data indicated that the inbound delay was greater (and perhaps much greater) than the outbound delay, in contrast to the NAPRS data. The data provided by United included a breakdown by flight phase (Table 6). It shows the large proportion of delay time associated with upline gate-holds at the originating airports. The conclusion supported our suspicion that the NAPRS statistics neglected to account for a significant portion of potentially avoidable delay.

Table 6
Breakdown of Average Daily Weather Delay Minutes
by Flight Phase for Weather at O’Hare International Airport

	Gate Hold Upline	Taxi-Out Upline	En route	Gate Hold at ORD	Taxi-Out at ORD
Baseline Clear Day	229	0	0	15	0
Average Fog Day	3699	515	479	17	1179
Average Thunderstorm Day	1655	860	880	15	1943

Discussion with airline personnel also emphasized that estimates of cost benefits should not be restricted to reduced delay time. Other benefits involving airlines savings and advantages were cited, such as reduction of fuel consumption, flight cancellations, diversions, and re-scheduling. They also described less tangible benefits such as higher customer satisfac-

tion resulting from flight routing that may better avoid significant turbulence. Other non-airline benefits that were mentioned included improved efficiency of traffic handling by Central Flow when many regions are impacted by weather.

As part of the cost-benefit effort, Lincoln Laboratory also participated in the Joint Conference on Assessing Benefits of System Improvements Related to Weather, hosted by the FAA Aviation Operations Research (AOR) office. The objective was to create a framework for performing cost benefit analyses for current and future weather system development. Lincoln representatives contributed several recommendations, including standardization of cost-benefit analysis procedures and development of a comprehensive data base to include items such as aviation accident reports, delay information, and weather data.

Continuing efforts in the area of cost-benefits analysis include further refinement of weather-related delay estimates and estimates of benefits that may be achieved in other areas, such as airline savings and improved traffic handling by Central Flow. Delay estimate refinements will be a combination of further analysis of the validity of the NAFS data assumptions and conclusions (e.g., use of O'Hare as a representative airport for determining weather/delay relationship) and more specific analysis of weather delays at selected airports, using Flight Data Strip data and first-hand observations. Further assistance will be pursued from airlines regarding assessment of benefits derived from reduced cancellations, diversions, fuel tankering, etc.

8.5. PRODUCT DATA REQUIREMENTS

8.5.1. Background

Definition of the data (e.g., resolution, update rate, quality, etc.) required to provide the various ITWS products is important for determining ITWS communications and processing load and for system architecture studies. Data sources that are found to be cost effective will appear in the ITWS Interface Requirements Definition documentation. Lincoln was tasked to provide product data requirements to Martin Marietta to be used as background material in the Functional Requirements document for KDP-2.

8.5.2. FY92 Accomplishments

The required and desired data sources for all of the ITWS products were defined by the product developers and provided to Martin Marietta. A very rough estimate was made of the relative importance of the various products. However, until the actual product algorithms have reached a relatively mature state, it will not be possible to provide site specific quantitative tradeoffs as to the contribution of each data source to the various products.

8.5.3. FY93 Plans

The data requirements for the various ITWS products will be refined as the various IOC algorithms reach a more mature state. It is anticipated that site specific issues regarding particular data sources (e.g., which NEXRADS are likely to be useful for a given terminal area) will arise out of FAA System Engineering system architecture studies and will need to be addressed. Data requirements will be determined for ITWS products that are added or changed subsequent to KDP-2.

8.6. ACQUISITION PLAN SUPPORT

8.6.1. Background

An initial version of the acquisition plan was required for KDP-2. Lincoln provided technical input to the Aviation Weather Development Program for the KDP-2 acquisition plan.

8.6.2. FY92 Accomplishments

Lincoln provided recommendations for a "fast track" competitive procurement under the A-109 process using an approach similar to that successfully used for the TDWR program. A new factor which needed to be considered was providing gridded winds to "hardened" CTAS prototypes at up to five major airports while the production ITWS systems were being developed. Key elements of the recommended process include:

1. Development of initial functional prototypes to support data acquisition for product algorithm development and operational demonstrations to refine the ITWS functional requirements and operational concept.
2. A formal operational demonstration in 1994 with the draft ITWS IOC product generation algorithms to provide the basis for the full scale development decision (i.e., KDP-3) at the end of 1994. This demonstration would be conducted using the Lincoln developed functional prototype.
3. Release of a Request for Proposal in late CY94 with Lincoln developed specifications for the ITWS product generation algorithms.
4. "Hardening" of the ITWS functional prototypes to provide seven days/week 24-hour per day operation with minimal operator oversight at airports with CTAS "hardened" prototypes.
5. Continuation of ITWS operational demonstrations with the IOC and (as available) additional Phase 2 products (such as ceiling and visibility predictions) at several airports while the production contractor is developing the IOC ITWS systems in the 1996-1998 time frame.
6. Testing of production ITWS IOC system and release of the ITWS Phase 2 product specifications in 1998.
7. Deployment of the ITWS IOC production systems in late 1999.
8. The principal difference between the above recommended program and a "normal" FAA A-109 process is that the production contractor does not build a prototype system to be used for the operational demonstration in step (2). This reduces the overall time to deployment by approximately two years. The above recommendations were incorporated into the baseline ITWS acquisition plan for KDP-2.

Managing development of the many ITWS IOC products, functional prototype development and testing will be a major challenge for the FAA Aviation Weather Development

Program (ARD-80). To assist in this process, a very comprehensive WBS for the Lincoln ITWS activity was developed by Lincoln in conjunction with ARD-80. This includes all key elements and dependencies for developments of the ITWS IOC products and functional prototypes as well as the schedule for fleshing out the plans for Phase 2 product development. The overall WBS was developed using Project software (from the Microsoft Corporation) and currently has approximately 600 entries. Electronic and paper copies of the WBS were provided to ARD-80.

8.6.3. FY93 Plans

Studies will be made of alternative approaches to ITWS acquisition that might provide earlier production system deployment. It is not feasible to generate final IOC algorithm specifications earlier than the end of 1994. However, there are a variety of approaches whereby technology transfer to a production contractor could commence before the 1996 date in the baselined acquisition plan.

The WBS will be updated as the ITWS product and prototype development proceeds and as related systems (especially CTAS) refine their acquisition plans.

8.7. MASTER TEST PLAN

8.7.1. Background

An initial version of the master test plan is generally required for the KDP-2. Lincoln was tasked to provide input to the FAA Aviation Weather Development Program (ARD-80) for the ITWS master test plan.

8.7.2. FY92 Accomplishments

The principal focus for the FY92 master test plan technical support was to determine the principal ITWS technical and operational issues that would need to be addressed in the testing and to determine when the various issues would be addressed in the program. Figures 36 and 37 show the principal technical and operational issues identified in this effort. It was sug-

- 
- RELIABILITY AND QUALITY OF THE COMMUNICATION LINKS
 - COMPUTATIONAL CAPABILITY OF THE ITWS PROCESSOR
 - ACCESS TO DATA SOURCES AT RATES, RESOLUTIONS, AND QUALITIES REQUIRED
 - ACHIEVING THE DESIRED TECHNICAL PERFORMANCE OF THE ITWS ALGORITHMS

Figure 36. Principal ITWS technical issues for testing.

- PROCEDURES ISSUES ASSOCIATED WITH SAFETY PRODUCT TRANSFER BY DATA LINK TO PILOTS
- USAGE OF WEATHER-IMPACTED AIRSPACE PRODUCTS
- USAGE OF PLANNING PRODUCTS BY TMU, TMC, PILOTS
- ASSESSING ABILITY TO MEET TATCA'S NEEDS
- SITE-SPECIFIC PRODUCT ADAPTATION
- REVISING PRODUCT MIX AND OPERATIONAL CONCEPT AS RELATED SYSTEMS (E.G., AWP, AGFS, AAS) EVOLVE

Figure 37. Principal ITWS operational issues.

gested that the operational issues, the product generation algorithm performance issues, and many of the input data access issues could be addressed with the Lincoln functional prototypes. Demonstration of the reliability of the overall system would be accomplished with an early production unit. Draft material for the master test plan was provided to ARD-80 for review.

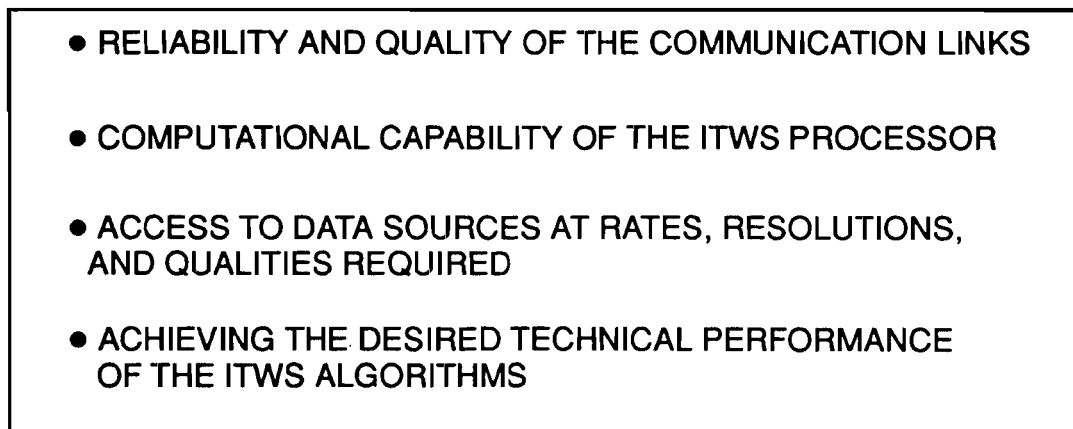
8.7.3. FY93 Plans and Issues

Additional analysis of a number of test issues will be conducted to provide input on all of the required sections of the Master Test Plan during FY93. Additionally, test plans will be developed for the tests to be conducted at Dallas-Ft. Worth and Orlando.

9. SUMMARY

This year marked an important transition in the ITWS program, from the concept phase to the demonstration phase as highlighted by the successful Key Decision Point-2 (KDP-2) evaluation which took place in December 1992. Much of the work discussed in this report focussed on addressing key elements of the preparation for the KDP-2 process, including:

1. Refining the ITWS needs as captured by the mission need statement, operations concept, and functional requirements documents through benefits and tradeoff studies,
2. Assessing the technical risk in two key areas: development of the ITWS IOC product generation algorithm and interfacing to all of the principal ITWS data sources, and
3. Assisting in development of the A-109 package for KDP-2, including alternative concepts, cost/benefits studies, functional requirements, and operations concept documents as well as gathering valuable experience for the demonstration phase by conducting limited real-time testing of key algorithms.

The benefits studies showed that previous estimates of the delays in the terminal area were significantly underestimated due to neglect of the the gate holds for departures and that a number of other significant costs (e.g., flight cancellations, diversions, fuel tankering, and delay incident recovery costs) also need to be considered. This was a very important finding that reemphasized the critical role of improved terminal weather information if delays and controller workload are to be reduced. The very high potential benefit associated with delay and controller workload reduction was carrier though to revisions in the mission need and operational concept documents to better reflect the areas of greatest benefit from ITWS.

Development of the ITWS product generation algorithms represents the greatest technical risk in the overall ITWS program. Significant progress occurred in this area for a number of key products:

1. The availability of appropriate data is critical for the algorithm development process. A very comprehensive data set from all of the principal ITWS data sources (i.e., TDWR, NEXRAD, AGFS, ACARS, AWOS/ASOS, ASR-9 and LLWAS) was obtained in Orlando during the summer. Additionally, data also was obtained from a number of supporting sensors, including two Doppler weather radars, instrumented aircraft, and a high-resolution terminal lightning mapping system to be used for quantitative technical performance evaluation and the development of enhanced products.
2. An initial version of the terminal winds algorithm was developed and demonstrated in real time at Orlando. Technical performance assessment and algorithm refinement is underway.
3. The microburst detection, trend and prediction product algorithms all reached a point where initial performance evaluation could commence.

4. The ITWS weather-impacted airspace product development was integrated into the overall Aviation Weather Development Program effort in this area. Software development commenced for the initial algorithm to integrate TDWR, NEXRAD and ASR-9 data.
5. The TDWR storm motion algorithm was generalized to provide a basis for a number of ITWS related applications, including snow band tracking and the tracking of storm cells.
6. Work commenced on developing ITWS text messages to be transmitted to pilots over the ACARS data link.

As a by-product of the data acquisition and real-time terminal winds demonstration, experience was gained in interfacing to all of the principal ITWS data sources. This experience (and that to be obtained in 1993-1994) will facilitate implementation of the ITWS functional prototypes for demonstration phase testing, refinement of the ITWS acquisition strategy, development of the ITWS Request for Proposal (RFP), and rapid progress by the ITWS production contractor.

In summary, rapid progress occurred in all of the key areas associated with the ITWS concept phase. Nevertheless, there are a number of major challenges which will need to be addressed in the coming year. These include:

1. Bringing all of the IOC product generation algorithms to a level of technical performance consistent with a formal operational demonstration in 1994,
2. Development of a functional prototype for executing all of the product generation algorithms,
3. Commencing product demonstrations to address key operational issues (including human factors issues) that can only be examined in the context of ATC decision making at a weather-impacted airport,
4. More detailed cost/benefit studies to support site-specific system architecture design.

GLOSSARY

AAS	Advanced Automation System
ACARS	Aircraft Communications Addressing and Reporting System
ACCC	Area Control Computer Complex
AEL	Algorithm Enunciation Language
AFGL	Air Force Geophysics Laboratory
AGFS	Aviation Gridded Forecast System
AGL	Above Ground Level
ALPA	Air Line Pilot's Association
AOR	Aviation Operations Research
AP	Anomalous Propagation
ARINC	Aeronautical Radio, Inc.
ARTCC	Air Route Traffic Control Center
ARTS	Automated RAdar Terminal System
ASOS	Automated Surface Observing System
ASR-9	Airport Surveillance Radar
ATC	Air Traffic Control
ATIS	Automatic Terminal Information System
ATL	Atlanta International Airport
ATN	Aeronautical Telecommunications Network
AWDL	Aviation Weather Development Laboratory
AWDP	Aviation Weather Development Program
AWOS	Airport Weather Observing System
AWPG	Aviation Weather Products Generator
CAPS	Center for Analysis and Prediction of Storms
CASE	Computer-Aided Software Engineering
CG	Cloud-to-Ground
CRDA	Cooperative Research and Development Agreement
CTAS	Center-TRACON Advisory System
CWSU	Center Weather Service Unit
CY	Calendar Year
dBZ	Decibel (referenced to reflectivity factor Z)
DFW	Dallas-Ft. Worth International Airport
DVX	Denver International Airport
FAA	Federal Aviation Administration
FAST	Final Approach Spacing Tool
FMS	Flight Management System
FSL	Forecast Systems Laboratory
FY	Fiscal Year
GAO	General Accounting Office
GSD	Geographic Situation Display

IC	Intra-Cloud
IDE	Company that developed the StP CASE tool
IOC	Initial Operational Capability
ITWS	Integrated Terminal Weather System
KDP	Key Decision Point
LAMDA	Lincoln Advanced Microburst Detection Algorithm
LAPS	Local Analysis and Prediction System
LCD	Local Climatological Data
LETA	Lincoln Echo Top Algorithm
LEWP	Line Echo Wave Pattern
LLWAS	Low Level Wind Shear Alert System
MAPS	Mesoscale Analysis and Prediction System
MCO	Orlando International Airport
MDCRS	Meteorological Data Collection and Reporting System
MIGFA	Machine Intelligent Gust Front Algorithm
MIT	Massachusetts Institute of Technology
NAPRS	National Airspace Performance Recording System
NASA	National Aeronautics and Space Administration
NCAR	National Center for Atmospheric Research
NEXRAD	Next Generation Weather Radar
NOAA	National Oceanic and Atmospheric Administration
NSSL	National Severe Storms Laboratory
NWS	National Weather Service
NWSFO	National Weather Service Forecast Office
OMB	Office of Management and Budget
ONERA	Office National d'Etudes et de Recherches Aerospatiales
OOSD	Object Oriented Software Design
PARC	Product Advisory Review Committee
RFP	Request for Proposal
RMMS	Remote Maintenance Monitoring System
RMS	Root Mean Square
SAO	Surface Observation
SFO	San Francisco International Airport
SSA	Severe Storms Analysis
StP	Software through Pictures
T-LAPS	Terminal area Local Analysis and Prediction System
TATCA	Terminal Area Traffic Control Automation
TCAS	Traffic alert and Collision Avoidance System
TCCC	Terminal Control Computer Complex
TDLS	Tower Data Link System
TDWR	Terminal Doppler Weather Radar
TITAN	Thunderstorm Identification, Tracking, Analysis, and Nowcasting
TMC	Traffic Management Coordinators

TMS	Traffic Management System
TMU	Traffic Management Unit
TRACON	Terminal Radar Approach Control
TVS	Tornado Vortex Signature
UA	United Airlines
UK	United Kingdom
UND	University of North Dakota
VAD	Velocity Azimuth Display
VHF	Very High Frequency
VIL	Vertically Integrated Liquid Water
VWP	Vertical Wind Profile
VWS	Vertical Wind Shear
WBS	Work Breakdown Structure
WIA	Weather Impacted Airspace
WSO	Weather Service Office
WSP	Wind Shear Processor
ZJX	Jacksonville, FL en route center (ARTCC)

REFERENCES

- [1] Weber, M.E., M.L. Stone, J.A. Cullen, "Anomalous Propagation Associated with Thunderstorm Outflows," MIT Lincoln Laboratory, *Proceedings of 26th International Conference on Radar Meteorology*, Norman, OK, 24–28 May 1993, Amer. Meteor. Soc.
- [2] Bowles, R.L., "Reducing windshear risk through airborne systems technology," 17th Congress on the Aeronautical Sciences, Stockholm, Sweden, September 9–14, 1990.
- [3] Wolfson, M.M., 1990: *Understanding and Predicting Microbursts*. Ph.D. thesis, Massachusetts Institute of Technology, 303 pp.
- [4] Delanoy, R.L., J.G. Verly, and D.E. Dudgeon, 1991: Pixel-level fusion using "interest" images. Proceedings, *4th National Symposium on Sensor Fusion*, Orlando, April 2–4.
- [5] Troxel, S. and Engholm, C. "Beam filling loss adjustments for ASR-9 weather channel reflectivity estimates," MIT Lincoln Laboratory, Lexington, MA, ATC-177, 23 October 1990.
- [6] DeLaura, R., M.M. Wolfson and P.S. Ray, "A hybrid Cartesian windfield synthesis technique using a triple Doppler radar network," American Meteorological Society, *Preprints: 25th International Conference on Radar Meteorology*, Paris, France, June 24–28, 1991.
- [7] Targ, R. and Bowles, R.L., "Investigation of airborne lidar for avoidance of windshear hazards," AIAA Conference on Sensors and Measurement Techniques for Aeronautical Applications, Atlanta, GA, 1988.
- [8] Saljoughy, A., V.P. Idone, R.W. Henderson, "A further assessment of the peak current calibration of the National Lightning Detection Network (NLDN) using triggered lightning observations," EOS, *Trans. Am. Geophys. Union*, 27 October 1992.
- [9] Wanke, C. and R.J. Hansman, "Hazard evaluation and operational cockpit display of ground-measured wind shear data," *Journal of Aircraft*, Vol. 29, No., 3, pp. 319–325, May 1992.
- [10] Phillips, Edward H., "Pilots, human factors specialists urge better man-machine cockpit interface," *Aviation Week and Space Technology*, pp. 67–68, March 23, 1992.
- [11] Hughes, David, "Pilots support 767 automated cockpit, but cite mismatch with ATC system," *Aviation Week and Space Technology*, pp. 52–55, March 23, 1992.
- [12] Hughes, David, "Pilots, research studies give mixed reviews to glass cockpits," *Aviation Week and Space Technology*, pp. 50–51, March 23, 1992.