

DOT-FAA-RD-82-5

**Project Report
ATC-113**

En Route Weather Data Extraction from ATC Radar Systems

D. Karp

11 March 1982

Lincoln Laboratory

MASSACHUSETTS INSTITUTE OF TECHNOLOGY

LEXINGTON, MASSACHUSETTS

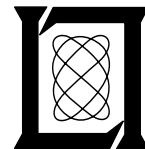

Prepared for the Federal Aviation Administration,
Washington, D.C. 20591

This document is available to the public through
the National Technical Information Service,
Springfield, VA 22161

This document is disseminated under the sponsorship of the Department of Transportation in the interest of information exchange. The United States Government assumes no liability for its contents or use thereof.

1. Report No. DOT-FAA-RD-82-5		2. Government Accession No.		3. Recipient's Catalog No.	
4. Title and Subtitle En Route Weather Data Extraction from ATC Radar Systems				5. Report Date 11 March 1982	
				6. Performing Organization Code	
7. Author(s) David Karp				8. Performing Organization Report No. ATC-113	
9. Performing Organization Name and Address Massachusetts Institute of Technology Lincoln Laboratory P.O. Box 73 Lexington, MA 02173-0073				10. Work Unit No. (TRAIS)	
				11. Contract or Grant No. DT-FA01-80-Y-10546	
12. Sponsoring Agency Name and Address Department of Transportation Federal Aviation Administration Systems Research and Development Service Washington, DC 20591				13. Type of Report and Period Covered Project Report	
				14. Sponsoring Agency Code	
15. Supplementary Notes The work reported in this document was performed at Lincoln Laboratory, a center for research operated by Massachusetts Institute of Technology, under Air Force Contract F19628-80-C-0002.					
16. Abstract This report describes the results of phase I of the En Route Radar Weather Program. The objective of this effort was to develop techniques for generating accurate en route weather reflectivity estimates in the presence of ground clutter. A candidate weather data extraction processor is proposed for use with either the ASR-MTD or ARSR-MTD radar systems. Principal features of the candidate processor include: <ol style="list-style-type: none"> (1) an antenna port (to permit use of an appropriate polarization), front end (with R² STC) and quadrature video sampling subsystem which are separate from that used for aircraft surveillance (2) use of a ground clutter map to select the form of clutter rejection to be used in each individual range-azimuth cell to estimate various weather reflectivity levels, and (3) spatial/temporal smoothing of the cell reflectivity estimates <p>The key elements of the suggested signal processing techniques were evaluated using data from MTD tests in Bedford, VA, Burlington, VT, and Atlantic City, NJ; however, the full system has not as yet received design validation/refinement and operational evaluation by ATC controllers. In particular, methods for identifying second trip weather echos should be addressed in the full system validation program.</p>					
17. Key Words Moving Target Detector (MTD) doppler clutter filtering Airport Surveillance Radar (ASR) ground clutter maps precipitation returns radar signal processor				18. Distribution Statement Document is available to the public through the National Technical Information Service, Springfield, VA 22151	
19. Security Classif. (of this report) Unclassified		20. Security Classif. (of this page) Unclassified		21. No. of Pages 48	22. Price

ABSTRACT

This report describes the results of phase I of the En Route Radar Weather Program. The objective of this effort was to develop techniques for generating accurate en route weather reflectivity estimates in the presence of ground clutter. A candidate weather data extraction processor is proposed for use with either the ASR-MTD or ARSR-MTD radar systems. Principal features of the candidate processor include:

- (1) an antenna port (to permit use of an appropriate polarization), front end (with R^{-2} STC) and quadrature video sampling subsystem which are separate from that used for aircraft surveillance
- (2) use of a ground clutter map to select the form of clutter rejection to be used in each individual range-azimuth cell to estimate various weather reflectivity levels, and
- (3) spatial/temporal smoothing of the cell reflectivity estimates

The key elements of the suggested signal processing techniques were evaluated using data from MTD tests in Bedford, VA, Burlington, VT, and Atlantic City, N.J.; however, the full system has not as yet received design validation/refinement and operational evaluation by ATC controllers. In particular, methods for identifying second trip weather echos should be addressed in the full system validation program.

IN MEMORY

David Karp, leader of the En Route Weather
Extraction Project at Lincoln Laboratory,
and author of this report, was the victim of
an auto accident on August 15, 1981.

ACKNOWLEDGMENTS

John R. Anderson contributed significantly to the analysis and proposed signal processor configuration as well as providing the filter response plots. Barbara Forman developed the clutter map analysis software. Technical direction, encouragement and discussions by Kenneth Coonley played an important role in the final product.

CONTENTS

I	INTRODUCTION	1
II	PROGRAM TO DATE	2
III	CANDIDATE RADAR FRONT-END AND SIGNAL PROCESSOR FOR WEATHER DATA EXTRACTION	4
	A. Front-End	4
	B. Digital Signal Processor	7
IV	CONCLUSIONS	18
	REFERENCES	20
APPENDIX A	WEATHER RADAR PERFORMANCE	A-1
	1. Candidate Radars	A-1
	2. Precipitation Return Comparisons	A-1
	3. Clutter/Weather	A-6
	4. ARSR Operation	A-11
	5. Multiple Trip Weather Echos	A-12
APPENDIX B	CANDIDATE CLUTTER FILTERS	B-1
APPENDIX C	LIST OF ACRONYMS AND ABBREVIATIONS	C-1

ILLUSTRATIONS

II-1	BVA Zero-Velocity Filter Output With Antenna Stationary	3
III-1	ARSR-MTD With Weather Channel Processor	5
III-2	Normalized Weather/Clutter Levels	6
III-3	Frequency Response of Candidate FIR Clutter Filter	8
III-4	57 dBz Cells Requiring Filter #1	9
III-5	50 dBz Cells Requiring Filter #2	10
III-6	50 dBz Cells Requiring Filter #1	11
III-7	46 dBz Cells Requiring Filter #3	12
III-8	46 dBz Cells Requiring Filter #1	13
III-9	41 dBz Cells Requiring Either Filter #2 or Filter #3 Mostly #2	14
III-10	41 dBz Cells Requiring Filter #3	15
III-11	30 dBz Cells Requiring Filter #3	16
A-1	ARSR-4 Front-end Performance Parameters (Assumed)	A-3
A-2	Storm Elevation Profile Data	A-5
A-3	Signal-to-Noise vs Range for Weather and Ground Clutter	A-7
A-4	Clutter/Weather Ratios for Specific Parametric Conditions	A-8
A-5	Bedford 30 dB Clutter 10 nmi Range Rings	A-9
A-6	Categories of Radar Wx Echo Intensity (As Related to NWS Levels)	A-10
B-1	4-Pulse Equiripple Finite Impulse Response Filter	B-2
B-2	4-Pulse Equiripple Finite Impulse Response Filter	B-3
B-3	Standard 2-Pulse Canceller	B-4
B-4	Standard 3-Pulse Canceller	B-5
B-5	ASR-MTD High-Pass Filter Response	B-6

I. INTRODUCTION

The purpose of Phase-I of the En Route Radar Weather Extraction Program was to develop and recommend techniques needed to generate accurate weather level signals in the en route environment. Emphasis was to be placed on the accurate measurement of precipitation reflectivity in the presence of ground clutter. The results of previous work in this area by the FAA, National Severe Storms Laboratory (NSSL), FAA Technical Center (FAATC), and the Johns Hopkins Applied Physics Laboratory were to be used as technical background for the study. The techniques used by the FAA in Ref. 1 and by the National Weather Service in Ref. 2 to provide six levels of weather information were investigated as a baseline for the feasibility and utility of this approach.

It should be emphasized that the principal objective of the Phase I studies was to examine a variety of candidate techniques using, when possible, actual Moving Target Detector (MTD) data to assess the performance limitations due to ground clutter. The resulting candidate weather radar front end and signal processor has been based on this practical experience, but has not as yet been fully implemented and evaluated in an operational environment.

Currently, weather information is obtained from the en route radars and sent to the Air Route Traffic Control Center (ARTCC) via the weather and fixed map unit (WFMU) and common digitizer (CD). The WFMU thresholds the radar video and the CD generates digital messages giving the azimuth and range of weather threshold crossings and transmits this information to the ARTCC where it is used to produce a digital display of the weather. The measurement of this weather data suffers from inaccuracies due to circular polarization (CP) attenuation, sensitivity time control (STC) attenuation, and the velocity response of the moving target indicator (MTI) circuitry used to eliminate ground clutter.

Modern radar digital signal processors have been developed which tend to eliminate the effects of ground clutter, angel false alarms, and precipitation echoes in order to furnish displayable target reports of moving aircraft only. These processors are suitable for use with the FAA L-Band radars used to perform surveillance functions in en route air space. To eliminate false alarms due to precipitation echoes, adaptive, linear constant false alarm rate (CFAR) techniques have been used in the Lincoln MTD radar signal processors. Under this program it was planned to use real-time MTD measurements in range-angle-velocity-space after normalization, to estimate the reflectivity factor (i.e., z-value) of precipitation returns.

The technique developed for use with the en route radar equipped with MTD processing uses a two-level ground clutter map to aid the weather extraction process^[3]. Basically the signal processor generates two sets of weather threshold crossings. One uses the total received energy of the radar returns

and the other uses only a linear combination of the non-zero doppler filter outputs. For high clutter cells, the non-zero frequency filter outputs are used. Otherwise the total received energy is used. These data are then integrated over three scans and spatially smoothed to generate a contoured weather map. This process is utilized for two selectable z-value levels of precipitation reflectivity.

II. PROGRAM TO DATE

A program to enhance the clutter performance of terminal (ASR) and en route (ARSR) radar systems by introducing MTD processing has been underway for some time (Ref. 3). As a by-product these MTD processors were adapted to produce two calibrated, contoured levels of rain reflectivity within coverage of the sensor. It was believed that a six-level weather extraction processor might reside in the back-up channel MTD processor, and use the fine-grain, temporally smoothed ground clutter map (maintained by the MTD for zero-velocity target thresholding against clutter) to subtract from the current measurement of weather plus ground clutter, producing a cell-by-cell estimate of weather only. Early efforts focussed on exploring this possibility by developing smoothed ground-clutter maps using the ASR-7/MTD at Lexington, MA; the ASR-7/MTD at Burlington, VT (BTV); the FPS-67/MTD at Bedford, VA (BVA); and the instrumented ASR-8 at the FAATC, Atlantic City, N.J. This study was conducted during the period January-September, 1979. However, by the fall of that year we were convinced that this technique could not be made to support weather extraction satisfactorily for the following reasons:

1) The estimate of ground clutter exhibited higher than expected variance because the "large" cross section cells consisted of only a few singularities, and the single-frequency radar measurement coupled with this feature produced low frequency variations which were tracked by the single-pole low-pass filter used for smoothing. The variations in mean radar cross section were as great as +6 dB, and it was determined that rejecting the ground clutter return at zero-velocity would be required in order to develop an estimate of the non-zero velocity components of the weather in the cell(s) of interest. An example of ground clutter amplitude variation with the BVA FPS-67 antenna stopped is shown in Fig. II-1.

2) Those cells that did not exhibit the above variations (wooded areas) did exhibit very slow variations of up to 6 dB from day to day, seemingly as a function of wet/dry conditions. The MTD processed approximately 5×10^5 range/azimuth clutter map cells ($1/16$ nmi x 0.7°), and although only 10% (above +30 dB C_1/N_0) were affected by the above problems, this was considered to be sufficiently severe (statistically) to prevent recommending that this technique be implemented.

Az = 300°
E_L TILT ≈ 1.5° (NOMINAL: -1°)
SAME CELL

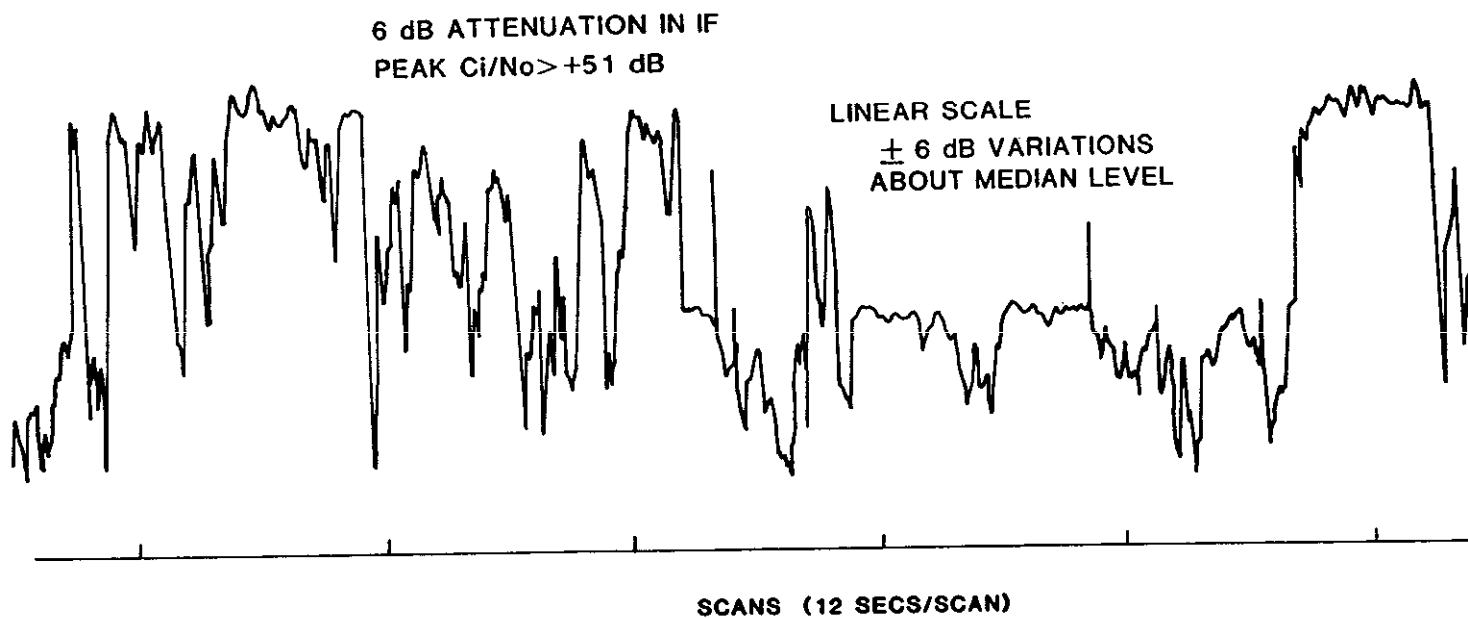

Fig. II-1. BVA zero-velocity filter output with antenna stationary.

3) Use of the ARSR/MTD processor for surveillance and multi-level weather extraction processing complicates the antenna polarization, range, and radar-STC normalization of the weather thresholds. If the system were to be hard-wired, and pre-computed normalized weather thresholds implemented in ordered range, then radar/weather processing could co-exist. However, the radar MTD sub-system was to be implemented using fault-tolerant architecture which allowed for restructuring of the processor to non-range order under software control. Thus to maintain this fault-tolerant architecture would require on-the-fly re-computation of weather thresholds module-by-module.

4) Finally, use of the Doppler filter bank optimized for aircraft detection for weather extraction processing was deemed inappropriate. This is true because a large fraction of the precipitation cells will have a velocity spectrum centered at zero radial velocity. Hence it would be necessary to exclude a large velocity interval around zero-velocity to minimize false aircraft target declarations. This low frequency filtering would suppress weather returns (along with the ground-clutter returns) and result in distorted weather contours.

The above considerations led us to investigate the possibility of implementing a separate weather channel processing system which could operate in parallel with, and independently of the MTD system. This, of course, gives up access to the MTD zero-velocity clutter map, but this was no longer considered to be useful for extracting weather attributes from weather-plus-ground-clutter radar cells.

III. CANDIDATE RADAR FRONT-END AND SIGNAL PROCESSOR FOR WEATHER DATA EXTRACTION

The remainder of this working paper deals with a candidate weather extraction processor for use with either the ASR-MTD or ARSR-MTD radar systems being developed for FAA-ATC aircraft surveillance. Also, included in the Appendices are a comparison of the weather return/receiver noise ratios for three candidate radars, data to place clutter and precipitation levels in perspective, comments on the operation of the ARSR/MTD in the field, and data on candidate clutter filters.

A. Front-End

A number of front-end configurations were considered, during the course of this study, and all could be made to support weather extraction. The candidate front-end configuration shown in Fig. III-1 is the preferred arrangement, as it decouples the weather channel from gain variations induced by changes in radar-STC curves. It does, of course, introduce a 1 dB loss in the primary channel, but this is considered acceptable as tilting the antenna

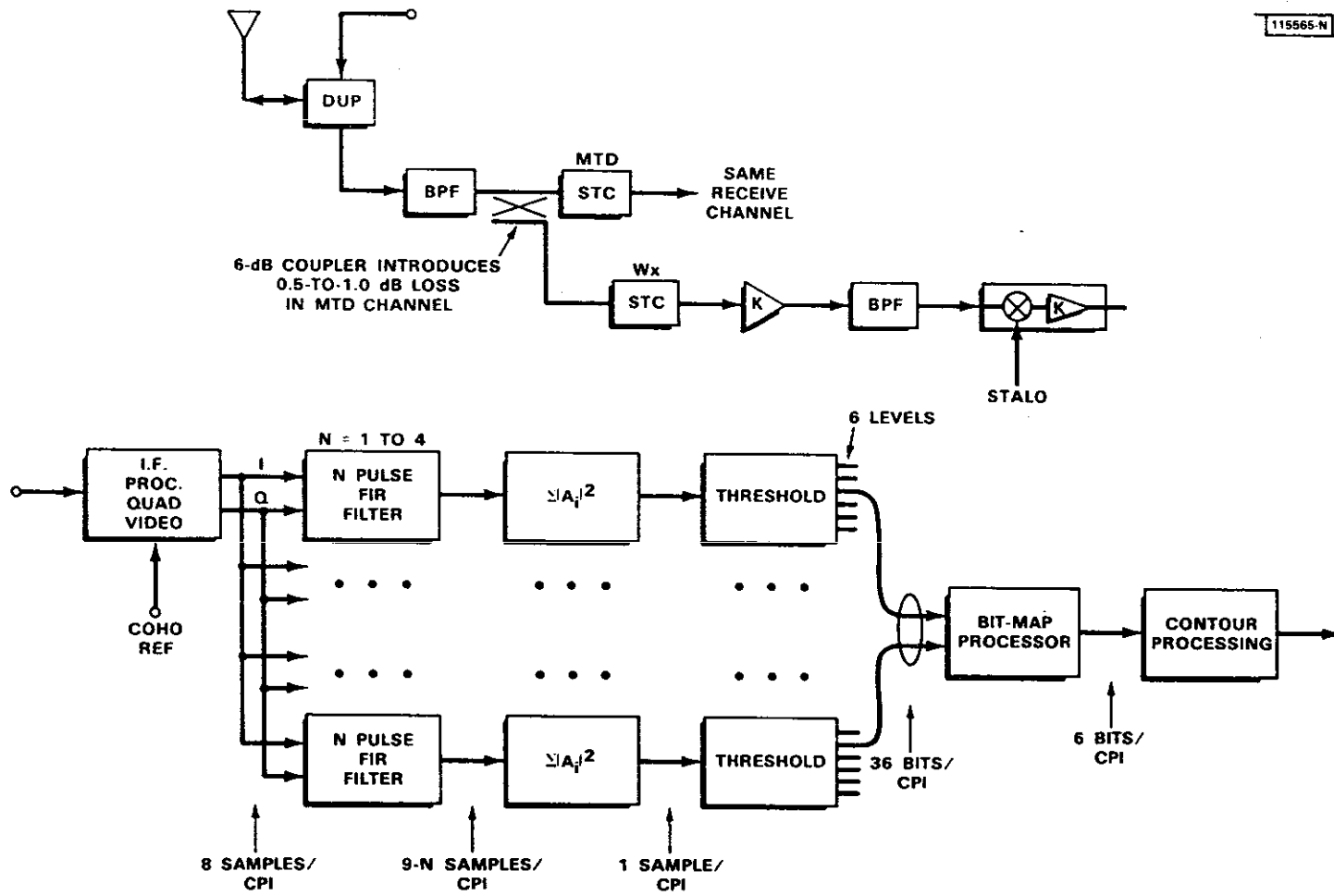

Fig. III-1. Functional block diagram ARSR-MTD with weather channel processor.

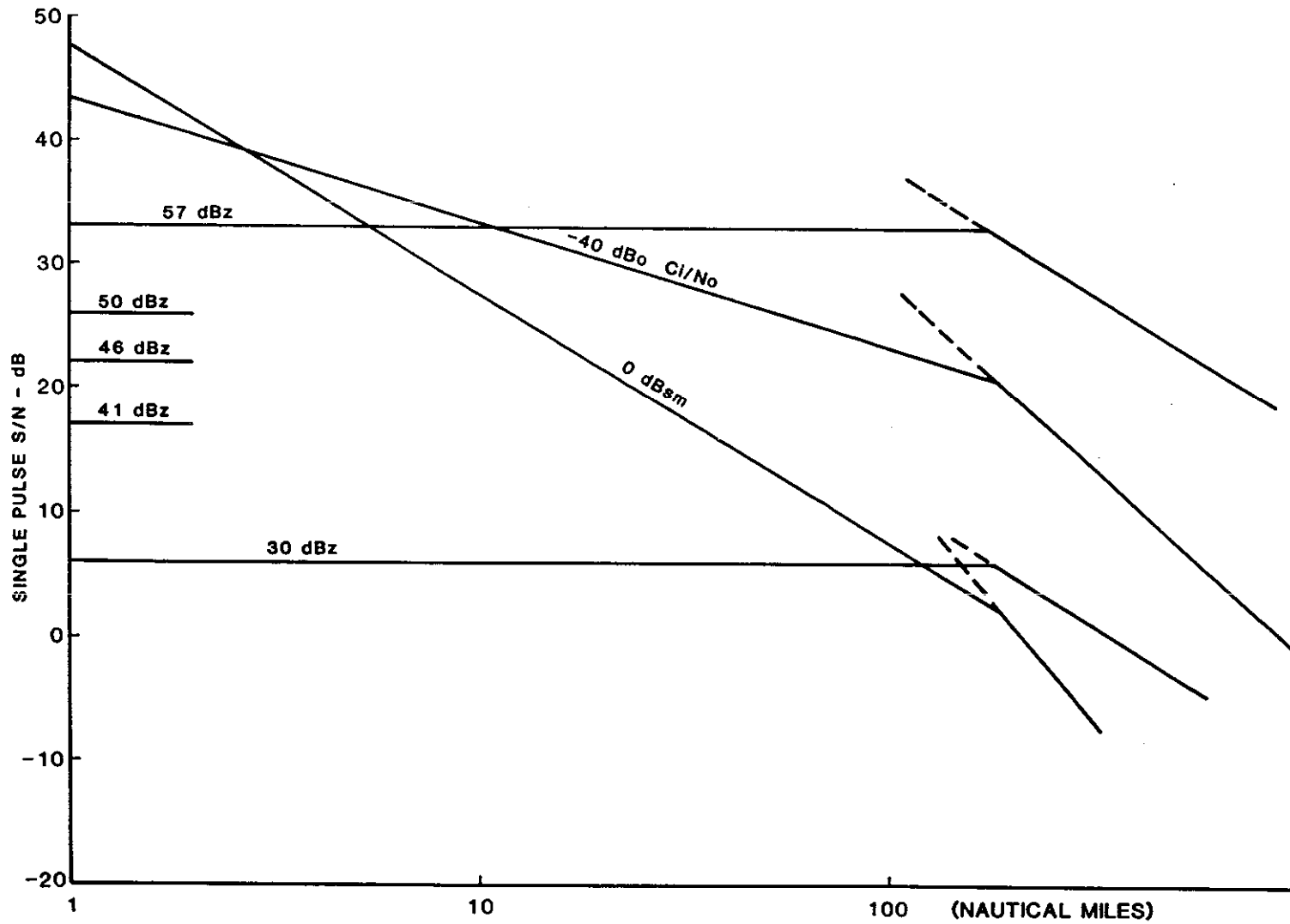

Fig. III-2. Normalized weather/clutter levels 6 dB coupling loss and $1/R^2$ - STC starting at 112 nmi.

down will more than compensate for this loss in the MTD channel. Translation to IF, quadrature video processing, and A/D converter sampling of I and Q variables is the same as specified for the ARSR-MTD. The weather channel STC should be operated at a $1/R^2$ rate, to normalize all weather signals as shown in Fig. III-2.

B. Digital Signal Processor

The high-speed digital signal processor (ground clutter filters) performs a function similar to the MTD Doppler filter bank, but is tailored to the weather/ground clutter problem, and operates slightly differently. A major element of this study was to characterize the ground clutter statistics as they applied to the weather extraction problem, and to develop a set of reasonable filters which would permit accurate estimation of weather in the presence of ground clutter. One obvious choice was an all-pass filter which would be optimum for large W_x/C_l range-azimuth cells, since this filter introduces zero-error into the weather estimate, and one of the two MTD filters for weather was all-pass. Most cells, for most weather levels, will be processed using this filter. Possibly 10% of the cells/levels will require high-pass filters to improve the W_x/C_l ratio prior to estimating the precipitation reflectivity. Another simple filter, which might be the next choice, is a four pulse Finite Impulse Response (FIR) filter. This filter would operate on the 8 pulses in a CPI (I and Q samples for each pulse) to yield 4 values of steady state output. The weather level would be estimated from these 4 values. The transfer function of this filter is shown in Fig. III-3. The clutter rejection for this filter is approximately -12 dB, which would handle the clutter at ranges greater than 20 km for most weather levels of interest. This filter will reject some of weather spectra which fall in the range from -2 m/s to +2 m/s and hence should only be used when necessary. The small percentage of range-azimuth cells which require more than 12 dB of clutter rejection could use 2-pulse or 3-pulse cancellers such as are described in Appendix B.

During the investigation of candidate filters, the clutter map, as recorded at BVA, was run against four filters, and a conservative clutter rejection requirement used to examine the resulting weather maps. The plots of Figs. III-4 to -11 show the location of cells requiring the use of a given level of filtering to achieve detection of weather signals of a specified intensity. The maps were prepared using alternate CPIs, yielding 256 azimuths, and the limiting range of clutter at BVA of approximately 80 nmi. There were 40960 range-azimuth cells ($1.4^\circ \times 1/2 \text{ nmi} \times 80 \text{ nmi}$) processed in covering the weather (636 one-eighth nmi gates were processed in one nmi blocks), and a choice of four clutter filters was available for each cell. The clutter cancellation of the filter(s) used in each mapping exercise is given in Table III-1; the response of each filter is as described in Appendix B.

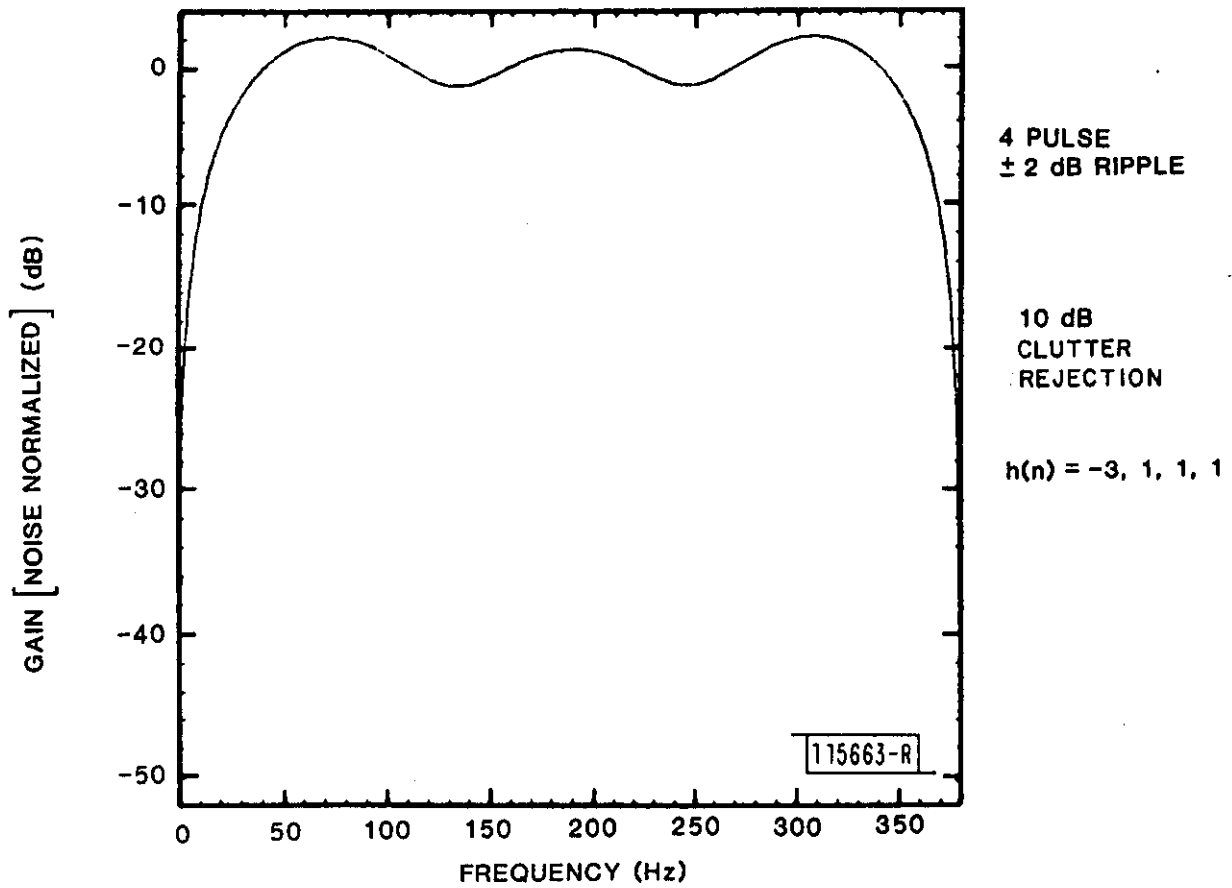
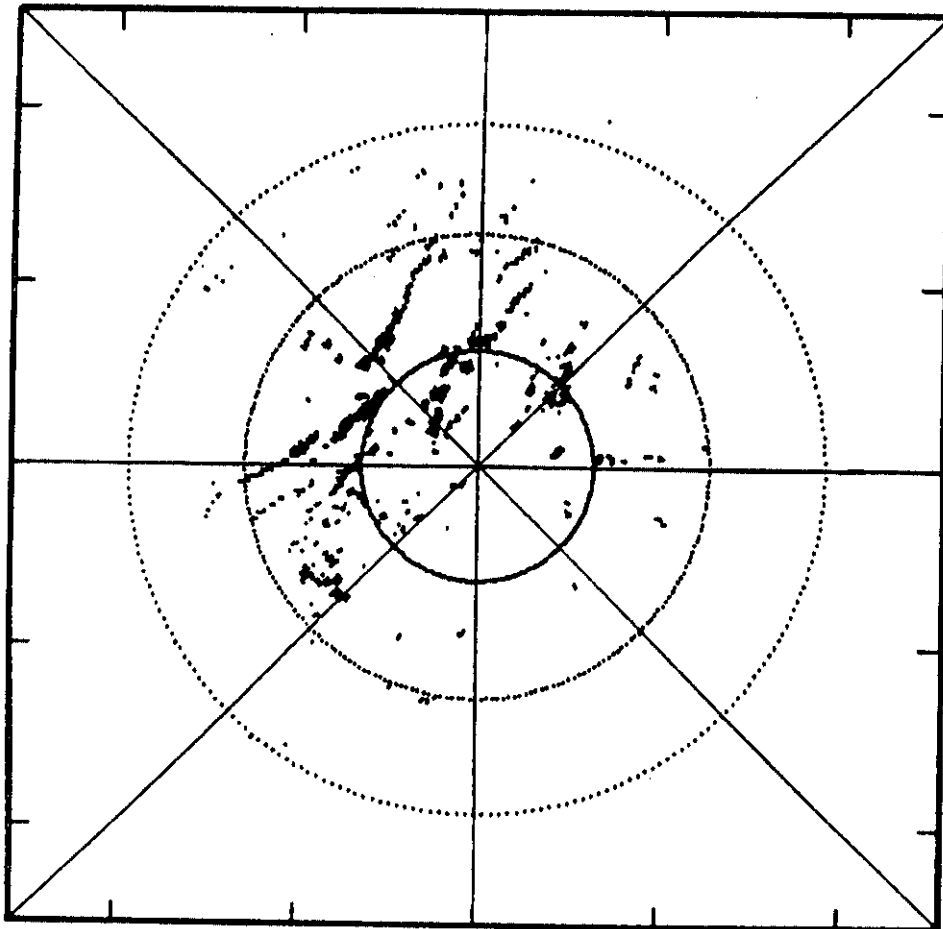
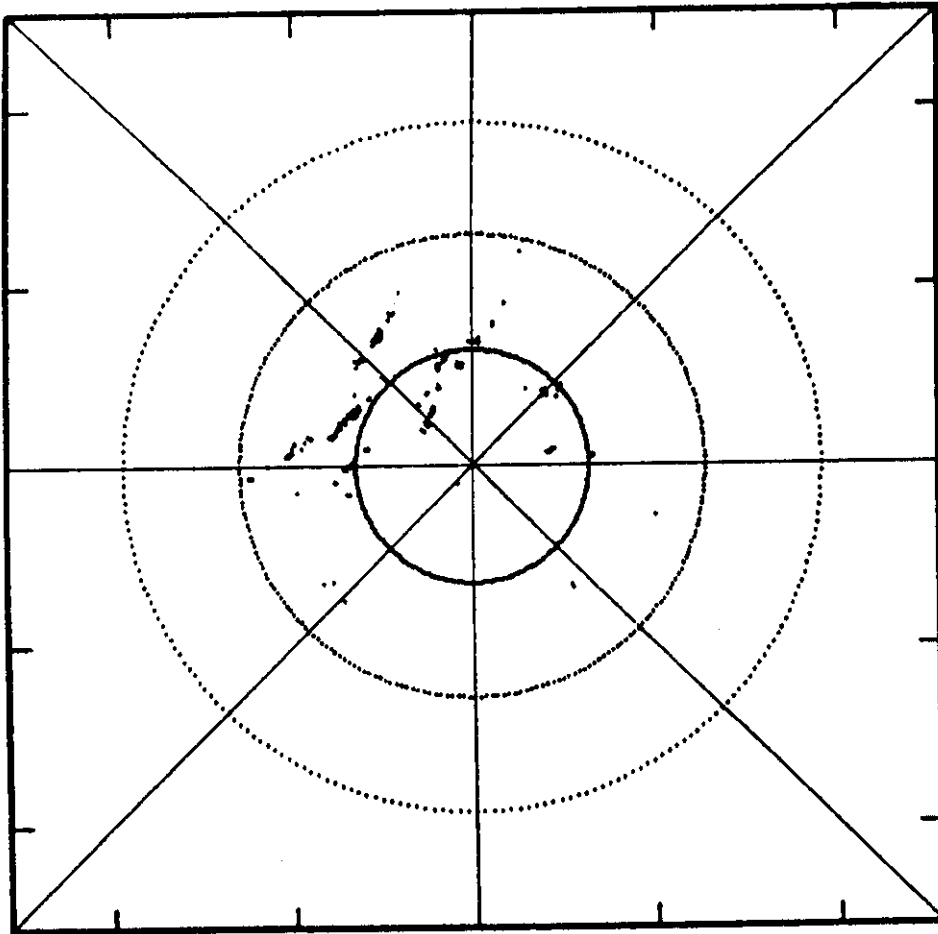

Fig. III-3. Frequency response of candidate FIR clutter filter.



20 NMI RANGE RINGS

Fig. III-4. 57 dBz cells requiring filter #1.



20 NMI RANGE RINGS

Fig. III-5. 50 dBz cells requiring filter #2.

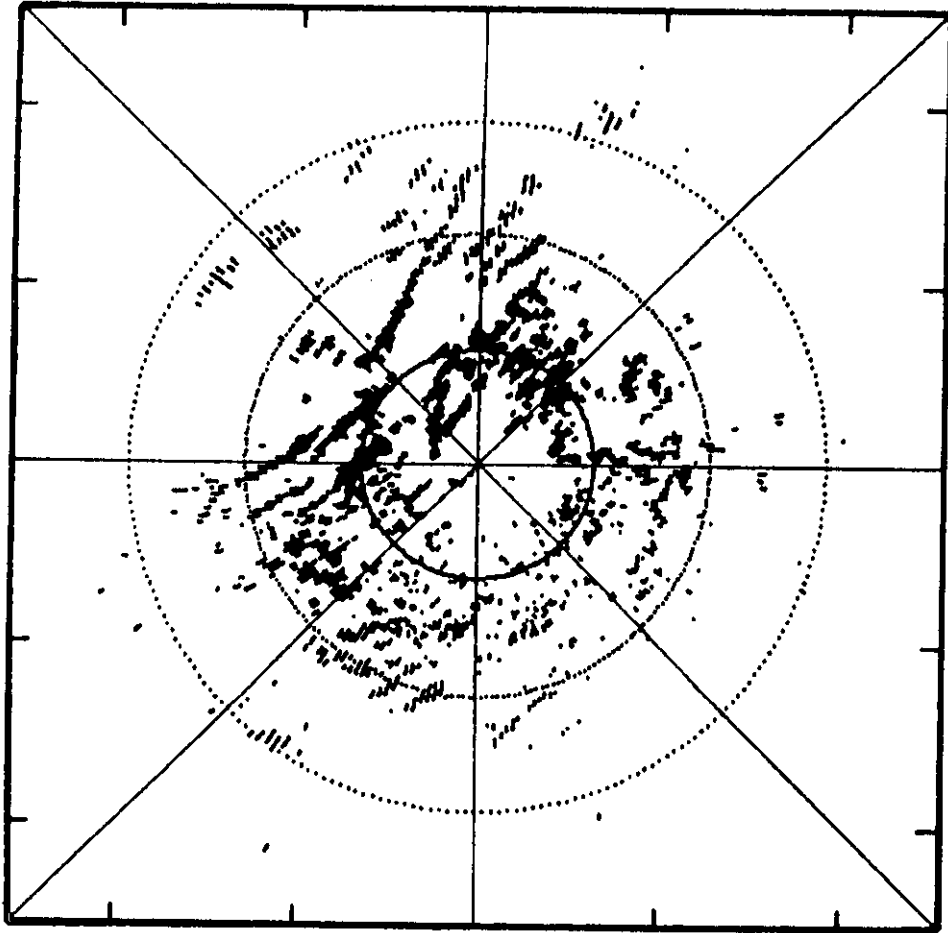

20 NMI RANGE RINGS

Fig. III-6. 50 dBz cells requiring filter #1.

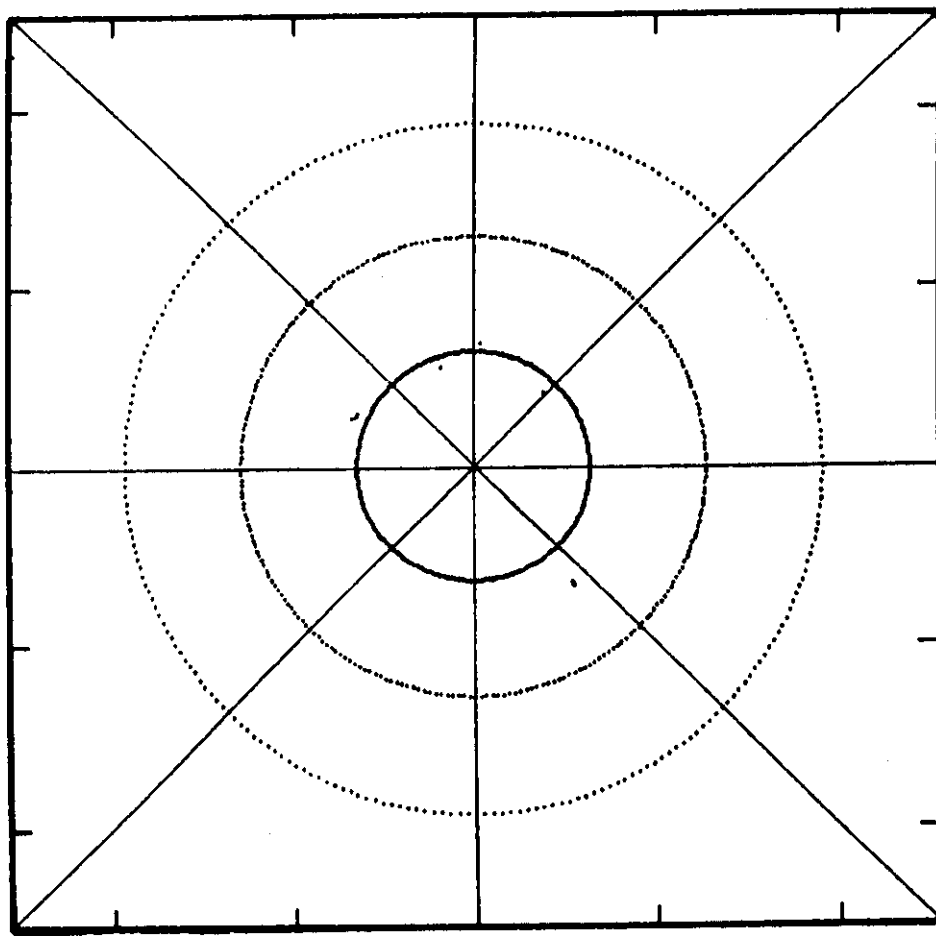

20' NMI RANGE RINGS

Fig. III-7. 46 dBz cells requiring filter #3.

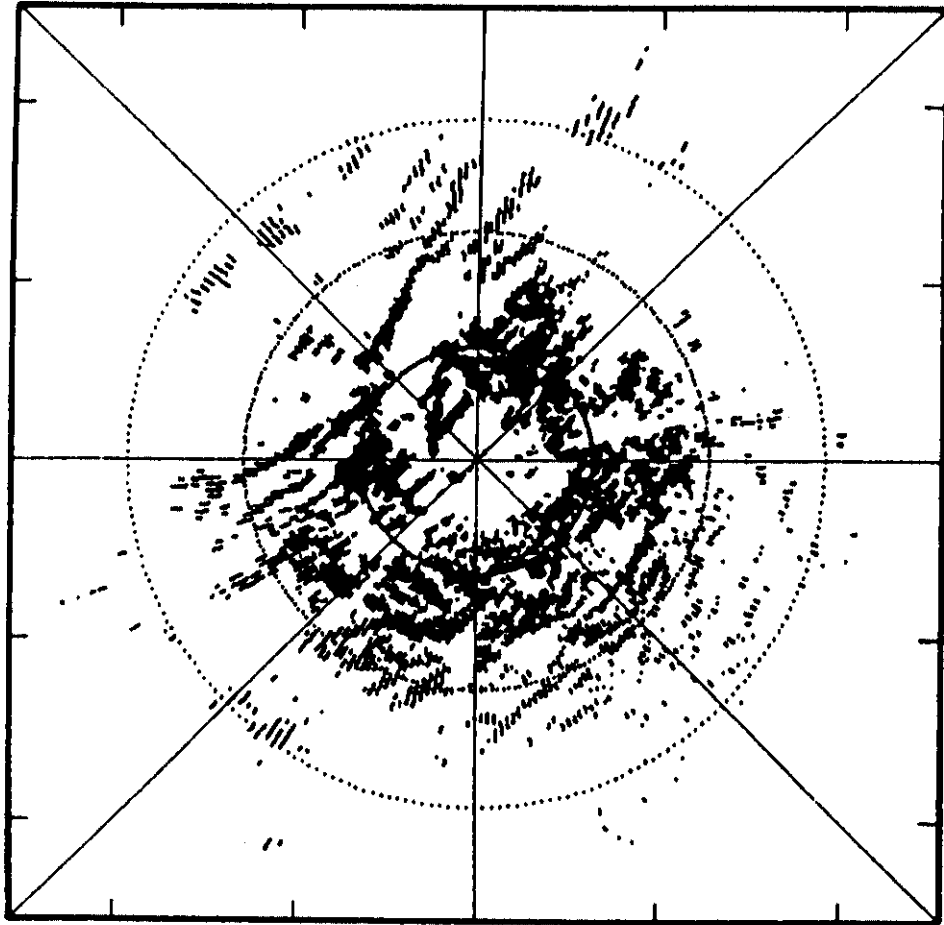

20 NMI RANGE RINGS

Fig. III-8. 46 dBz cells requiring filter #1.

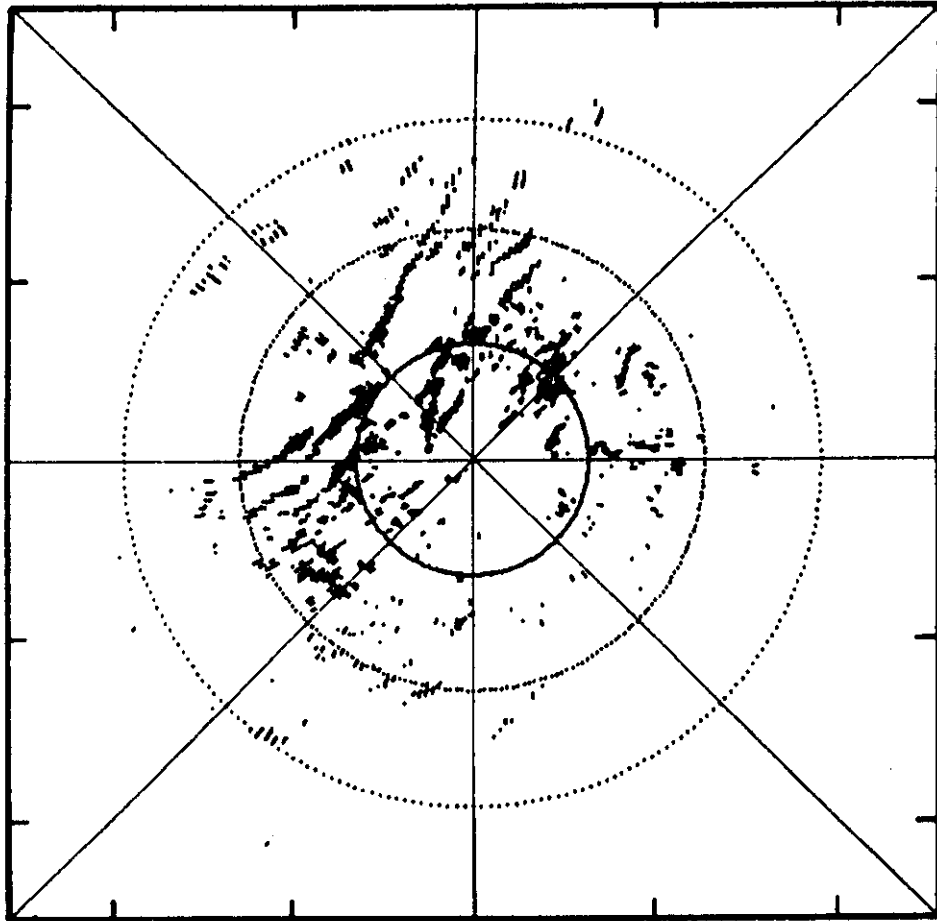

20 NMI RANGE RINGS

Fig. III-9. 41 dBz cells requiring either filter #2 or filter #3, mostly #2.

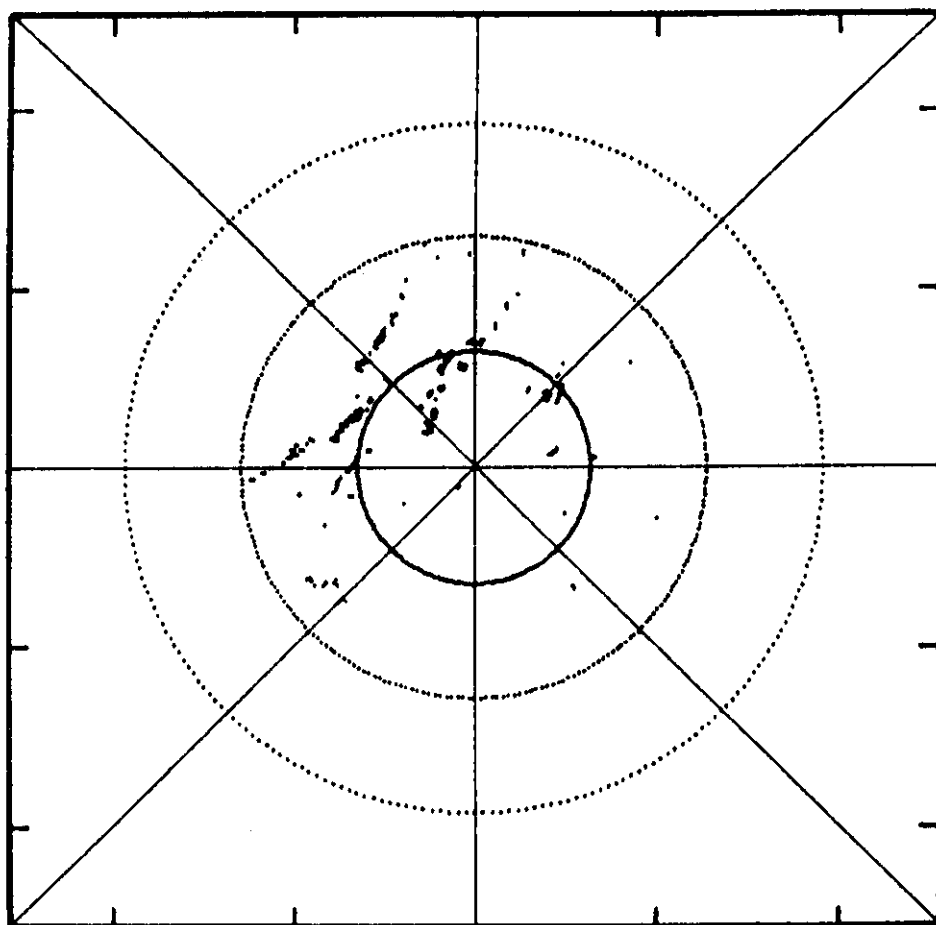

20 NMI RANGE RINGS

Fig. III-10. 41 dBz cells requiring filter #3.

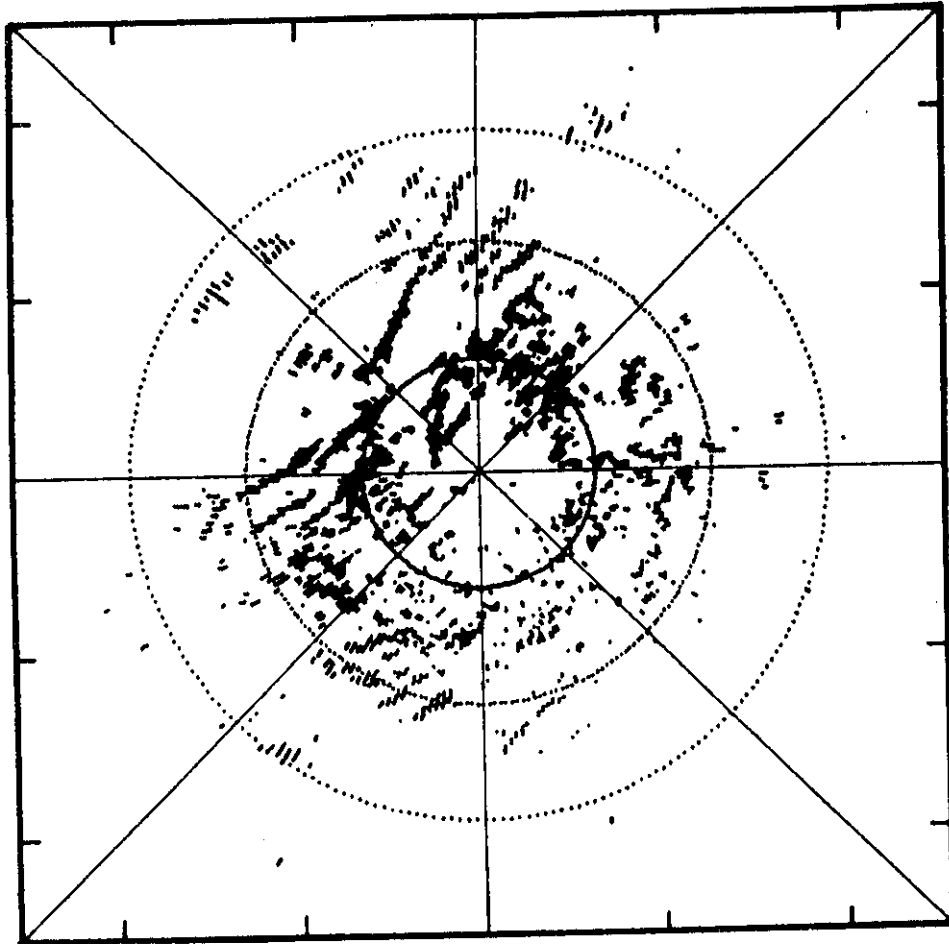

20 NMI RANGE RINGS

Fig. III-11. 30 dBz cells requiring filter #3.

TABLE III-1
WEATHER MAPPING EXERCISE SUMMARY

<u>Precipitation Level</u> <u>dBz</u>	<u>Descriptor</u>	<u>Cells Requiring Filter</u> <u>Type (Cancellation)</u>	<u>Figure</u> <u>III-</u>
57	Intense	1 (12 dB)	4
50	Very Strong	2 (20 dB)	5
50	Very Strong	1 (12 dB)	6
46	Strong	3 (40 dB)	7
46	Strong	1 (12 dB)	8
41	Moderate	2 or 3 (20 or 40 dB)	9
41	Moderate	3 (40 dB)	10
30	Weak	3 (40 dB)	11

The analysis was carried out using rain intensity values of 57, 50, 41, and 30 dBz corresponding to a range from intense to weak precipitation (Table III-1 summarizes the mapping exercise where the NWS levels of precipitation are as defined in Fig. A-6). For the intense precipitation, most of the cells can be processed by the all-pass or Type 0 filter; Fig. III-4 shows the few cells requiring Filter Type 1, a four pulse canceller. With less conservative criteria even fewer cells would require this filter. The 57 dBz intensity signals did not require the use of the 20 or 30 dB filters.

As the rain signal decreases in intensity, more clutter filtering is required as illustrated in Fig. III-5 and -6 which show the cells requiring the use of the 20 and 12 dB filters respectively. There were few cells which required the 20 dB filter. Further decreasing the intensity to 46 dBz requires more robust filtering as shown in Fig. III-7 and -8, where both the 46 dB filter is engaged for a few cells, and a large number of cells require the 12 dB filter. The 20 dB filter is required for processing the 41 dBz intensity level as is the 40 dB filter. See Fig. III-9 and -10. Again the number of cells requiring the large clutter attenuation is small. Finally, at the weakest intensity level, 30 dBz, the 40 dB filter is required to reject clutter in a large number of cells.

It is believed that a slight change in the clutter rejection criteria could reduce the need for the high-attenuation-value filters. Parametric analyses were not carried out for a number of other clutter rejection options.

Each filter operates on all data through weather level thresholding, at which point the site-dependent map selects one of four threshold declarations for each 1/2 nmi range interval. In the absence of rain, weather thresholds

are not declared, even though random threshold crossings occur. The map is created in clear weather, and iterated to reduce false declarations to "near zero".

Scan-to-scan smoothing, and contour start/stop detection is as specified for the ASR-9/MTD two-level weather extraction processor. Nominally, all five contour maps could be continually maintained and updated, but it is likely that only two would be displayed simultaneously, and it would, of course, be more cost effective to develop only the contours which are to be displayed. Still, this represents straightforward bit-map processing and relatively small, reliable special purpose microprocessors can be used, to support these functions.

IV. CONCLUSIONS

The ASR/MTD and ARSR/MTD radar systems can be used for weather data extraction, even though their beam patterns and scan rates are tailored for aircraft surveillance rather than radar meteorology. Based on our studies using clutter from BVA (chapter III) and the MTD-II experience at FAATC and Burlington, VT^[3], we have concluded that ground clutter can be automatically suppressed without "seriously" compromising the weather extraction function, using low-order digital filtering. Spatial/temporal smoothing and contouring algorithms developed for the MTD two-level weather extraction processor will support the six-level processor (five-thresholds). We see no advantage (and, several disadvantages) in combining MTD and weather extraction processing in a single unit, and recommend that they be implemented separately.

The key concepts involved in the candidate weather processing system are:

- (1) use of a static ground clutter map to select the form of clutter rejection to be used in a given range-azimuth cell
- (2) iteration of the ground clutter maps in a variety of clear weather situations to reduce false declarations
- (3) assessment of clutter rejection techniques based on actual clutter data
- (4) spatial/temporal smoothing and contouring
- (5) $1/R^2$ STC and A/D converter of I, Q sampling, and
- (6) an appropriate polarization for the weather channel.

These have individually been demonstrated over the past few years^[3-5]. However, it must be reemphasized that the full system design validation/refinement and ATC controller evaluation has not yet been carried out.

It should also be noted that there are substantial inaccuracies* (e.g., due to weather return statistics, breakdown of the beam-filling assumption and/or bright band occurrence) in the weather return estimates which one can obtain with an ASR or ARSR even when clutter is not present. In particular, the operational evaluation should consider:

- (1) methods of identifying and flagging situations in which second trip weather echos are contained in the estimated first trip weather data, and
- (2) the degree to which the use of a larger number of weather threshold levels for the ASR or ARSR may imply a greater accuracy in the estimates than is in fact the case.

*Appendix A discusses a number of these inaccuracies.

REFERENCES

- (1) K. Coonley, D. Hopson, "Use of Air Traffic Control Radars for Hazardous Weather Data", FAA Report 9550-1 #AAT-100-33.
- (2) E. B. Dobson, F. L. Robison, A. Arnold, T. G. Konrad, "Detection of Severe Weather by FAA Radars", Report No. FAA-RD-79-91, Final Report The Johns Hopkins University Applied Physics Laboratory, September, 1979,
- (3) D. Karp, J. R. Anderson, "Moving Target Detector (Mod II) Summary Report", ATC-95, Lincoln Laboratory, MIT, Project Report, November, 1981.
- (4) R. J. Doviak, D. S. Zrinc, D. S. Sirmans, "Doppler Weather Radar", Proceedings of the IEEE, Vol. 67, No. 11, November 1979.
- (5) J. Anderson, "Evaluating Ground Clutter Filters for Weather Radars", Preprints, 20th Conf. on Radar Meteor., Am. Meteor. Soc., Boston, Mass., 314-318, 1981.
- (6) B. G. Laird, "On Ambiguity Resolution by Random Phase Processing", 20th Conf. on Radar Meteor., Boston, Mass., Amer. Meteor. Soc., 327-331, Nov. 1981.
- (7) W. D. Zittel, "Echo Interpretation of Severe Storms on Airport Surveillance Radars", Report No. FAA-RD-78-60, National Severe Storms Laboratory, Norman, OK, April 1978.
- (8) K. E. Wilk and J. T. Dooley, "FAA Radars and Their Display of Severe Weather (Thunderstorms)", FAA-RD-80-65, National Severe Storms Laboratory, Norman, OK, July 1980.

APPENDIX A

WEATHER RADAR PERFORMANCE

1. CANDIDATE RADARS

The pertinent performance parameters for three radars of interest are listed in Table A-1. NEXRAD is a hypothetical next generation coherent radar operating at S-Band. It may be thought of as a possible contender for joint use by the FAA, the Air Force Weather Service and the National Weather Service as the next generation en route weather radar. The ARSR-4/MTD (see Fig. A-1) should be viewed as the present ARSR-3 modified by the type of front-end alterations described in this report and by the addition of MTD-type processing. Since design experience and field data has been obtained on a radar similar to the ASR-9/MTD, performance parameters have been included for it as well.

2. PRECIPITATION RETURN COMPARISONS

In the use of radar for precipitation measurement the principal properties have been the total returned power or the temporal variation of that power from storm regions. It is generally accepted that severe storms of the type that present significant hazards to aviation, contain greater quantities of larger water droplets and thus produce larger radar returns. The received power P_r from a volume of precipitation is:

$$P_r = \frac{P_t G_T G_R \lambda^2}{(4\pi)^3 R^4} \sigma_t$$

σ_t is calculated as follows, assuming the beam to be filled with hydrometeors ("hydrometeors"):

(Reflective scattering volume) x (Scattering coefficient, η)

$$\text{Volume} = \pi \left(\frac{R\theta}{2} \right) \left(\frac{R\phi}{2} \right) \cdot \frac{\pi}{8 \ln 2} \cdot \frac{C\tau}{2}$$

for Gaussian Beams, two-way, and

$$\eta = \frac{5.6 \times 10^{-14} r^{1.6}}{\lambda^4}$$

where:

r = rain rate in mm/hr.

TABLE A-1

COMPARISON OF W_x/N_0 FOR CANDIDATE RADARS

Parameter	NEXRAD	ARSR-4/MTD	ASR-9/MTD
P_t	1×10^6 watts	2×10^6 watts	1×10^6 watts
G	+43 dB	+33.5 dB	+33.5 dB
θ	1° azimuth	1.5° azimuth (one-way 3 dB width)	1.3° azimuth
ϕ	1° elevation	5.0° elevation (one-way 3 dB width)	4.8° elevation (with CSC ² mods)
T	1 μ sec	2 μ sec	1 μ sec
L	1 dB	3 dB	2.5 dB
L_t	1 dB	2 dB	2.0 dB
L_p	1 dB	1 dB	1.0 dB
NF	1.5 dB	3 dB	3.0 dB
BW_e	1 MHz	500 KHz	1 MHz
R	10 Km ; Z = 30dBz	10 Km, Z = 30 dBz	10 Km ; Z = 30dBz
P_r	-63 dBm	-77 dBm	-76.5 dBm
N_0 (= K T BW_e NF)	-112.5 dBm	-114 dBm	-111.0 dBm
W_x/N_0	+50 dB	+37dB	+34 dB

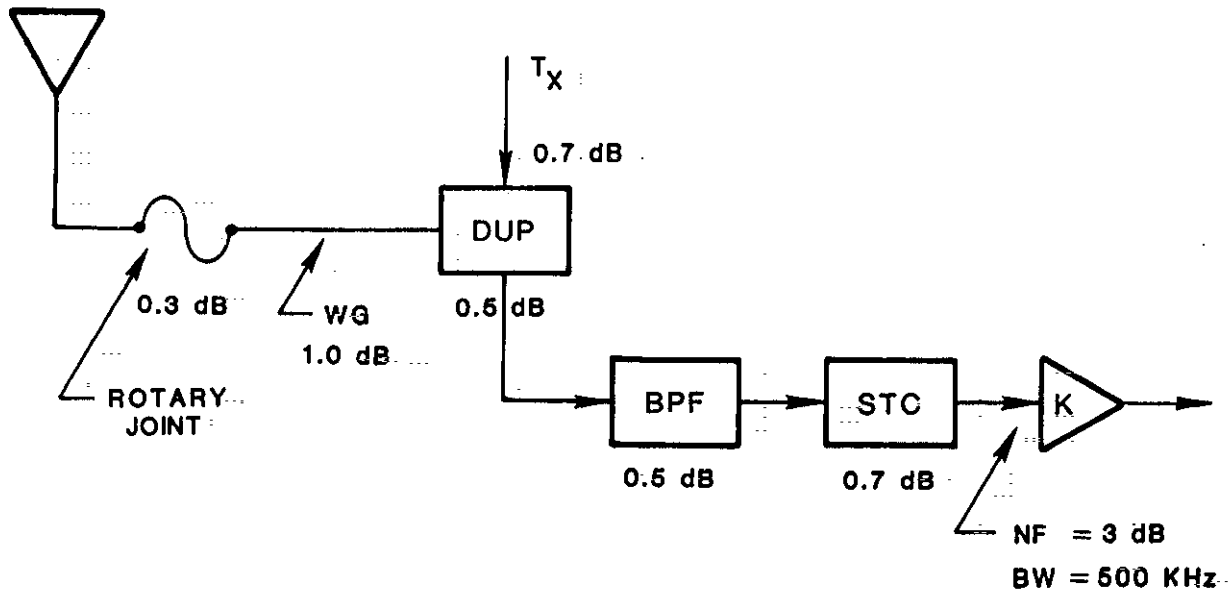

LOSSES

$L_R \approx 3$ dB RECEIVE LINE LOSSES

$L_T \approx 2$ dB TRANSMIT LINE LOSSES

$L_P \approx 1$ dB PROPAGATION LOSS

Fig. A-1. ARSR-4 front-end performance parameters (assumed).

When applying this equation to the en route radar, several factors deserve consideration. The first is the statistical nature of the received power from precipitation. A single measurement is likely to contain large errors. A second factor is the beam-filling assumption used in the derivation of this equation. While this is a good approximation for radars with a narrow pencil beam, such as those used by weather radars, for a fan beam radar it may underestimate the severity of the storm because of non-uniform height profiles or low altitude storms may only partially fill the antenna beam.

This problem was pointed out in Ref. 1 by Coonley and Hopson. An example of storm profile data is shown in Fig. A-2. These data indicate that the average power from integrating over the coverage height will, in general, indicate a lower z value than the maximum actual z value in that cell. For example, in Figure 3 of the reference, at 85 Km, where a 40 dBz region occurred between 4 to 6 Km altitude, the volume-average is below 30 dBz.

Another factor is that non-weather related targets within the beam coverage introduce errors in the measurement accuracy. For the en route radar the need to provide low altitude aircraft coverage, necessarily introduces substantial ground clutter return energy in the received signal.

The processor will use 8 pulses per range gate to estimate Pr, and therefore z-level. The ARSR will operate at approximately 400 Hz, thus the CPI interval will be 20 msec. The weather signal is substantially correlated pulse-to-pulse (2.5 msec), but does de-correlate to some extent over the CPI-interval. The extent of de-correlation is related to the velocity width of the return, and for purposes of generating a typical value for de-correlation, the spectral width is assumed to be Gaussian with 2 msec variance, yielding an effective doppler width of 43.5 Hz. The number of effective independent samples is given by

$$N_{\text{eff}} = 2WT$$

$$\begin{aligned} \text{where } W &= 43.5 \text{ Hz and} \\ T &= 20 \text{ msec} \end{aligned}$$

Thus there are approximately two independent samples per gate per CPI. Eight range gates will be summed, and it is assumed that these samples are essentially uncorrelated, yielding the equivalent of 16 independent samples for estimating the z-level. Using either voltage or power summation (approximately) the one-standard deviation of the estimate will be about 1 dB. The estimate variance will be somewhat greater for narrower width weather returns, and somewhat smaller for wider width weather returns. Scan-to-scan and spatial smoothing improve the estimator to some extent, and our experience with the ASR-MTD two-level processor indicates that this form of z-level intensity estimation will be adequate.

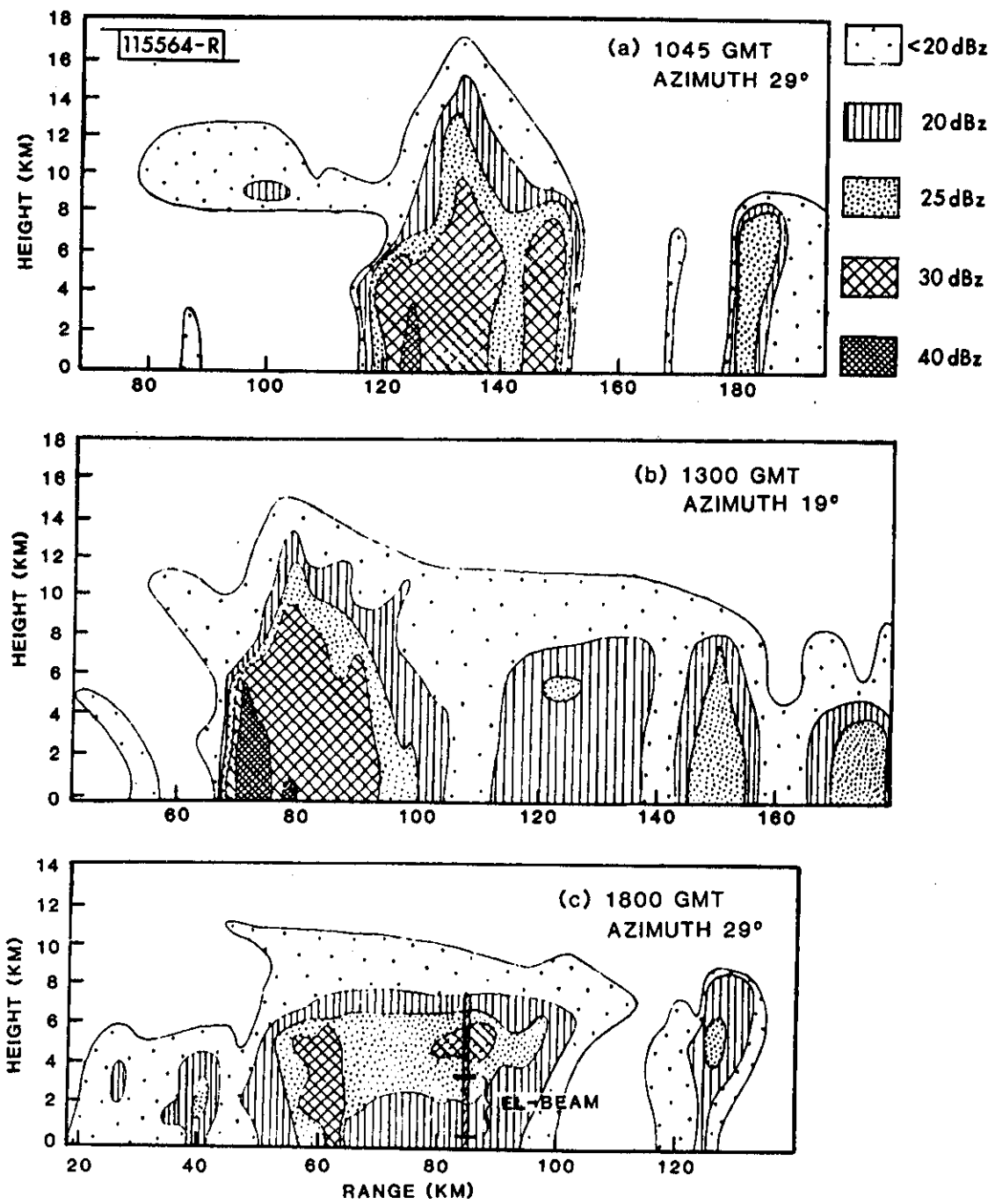

Fig. A-2. Storm elevation profile data.

3. CLUTTER/WEATHER

Figures A-3 and A-4 provide some perspective on the dynamic range of the signals involved and the relationship between ground clutter and weather returns for the candidate ARSR and NEXRAD systems likely to be operated at L-band and S-band by the FAA in the future. Figure A-3 shows parametric curves of S/N for weather and ground clutter returns for the ARSR-4/MTD operating at L-Band and the NEXRAD, a next generation coherent weather radar, operating at S-Band. Fig. A-4 shows the Clutter/Weather ratios for these systems for specific but important parametric conditions. The weather level chosen is the upper bound of the NWS weather level 1 region, and would be the lowest level processed for extraction by the ARSR system. The ground clutter back scatter coefficient of -40 dB_0 is typical of much terrain that would be visible to en route weather radars: The important features of these curves are:

- a. Very wide dynamic range, especially when -10 dB_0 clutter is considered, and weather levels greater than $+70 \text{ dBz}$.
- b. With the beams pointed at their lowest useful elevation angles (for long range coverage) C_i/W_x ratios are high, and some clutter mitigation is required, in order to extract weather information without attendant ground clutter false alarms.
- c. The ARSR problem is more difficult at this elevation angle, and it stays that way, whereas the NEXRAD system does tilt up and gets substantial relief in-close from typical ground clutter. At 1.5° elevation (for NEXRAD) with a -25 dB first side-lobe (one-way) the close-in ground clutter problem for $+30 \text{ dBz}$ weather is non-existent. The ARSR operates at this elevation for enhanced long-range A/C coverage and must cope with the ground clutter on each scan.

Another feature shown in fig. A-3 is the ARSR C_i/N_o after typical radar $1/R^4$ -STC front-end attenuation (typical of BVA-MTD operation). In the range 20-100 Km the C_i/N_o is approximately $+30 \text{ dB}$. Fig. A-5 shows a $+30 \text{ dB}$ C_i/N_o map of BVA, obtained using a dump of the temporally smoothed ground clutter map. C_i/N_o exceeds $+30 \text{ dB}$ within the closed contours, and therefore represents regions exhibiting higher than -40 dB_0 ground clutter reflectivity. These regions therefore, in the absence of weather, exceed the 30 dBz weather level threshold by at least 18-25 dB (it would be 10-17 dB for NEXRAD), and zero-velocity clutter suppression is required to avoid false weather display. For this particular site much of the hilly terrain subtends negative elevation angles to the radar, and NEXRAD would have a smaller percentage of the area exceeding this threshold level. Beyond 50 nmi at BVA, very few range-azimuth cells will require clutter mitigation, even at the lowest weather threshold (30 dBz). A chart of the NWS weather levels is shown in Fig. A-6. For the highest weather threshold (57 dBz), only a few singularities would require clutter filtering or possibly fixed-map censoring.

A-7

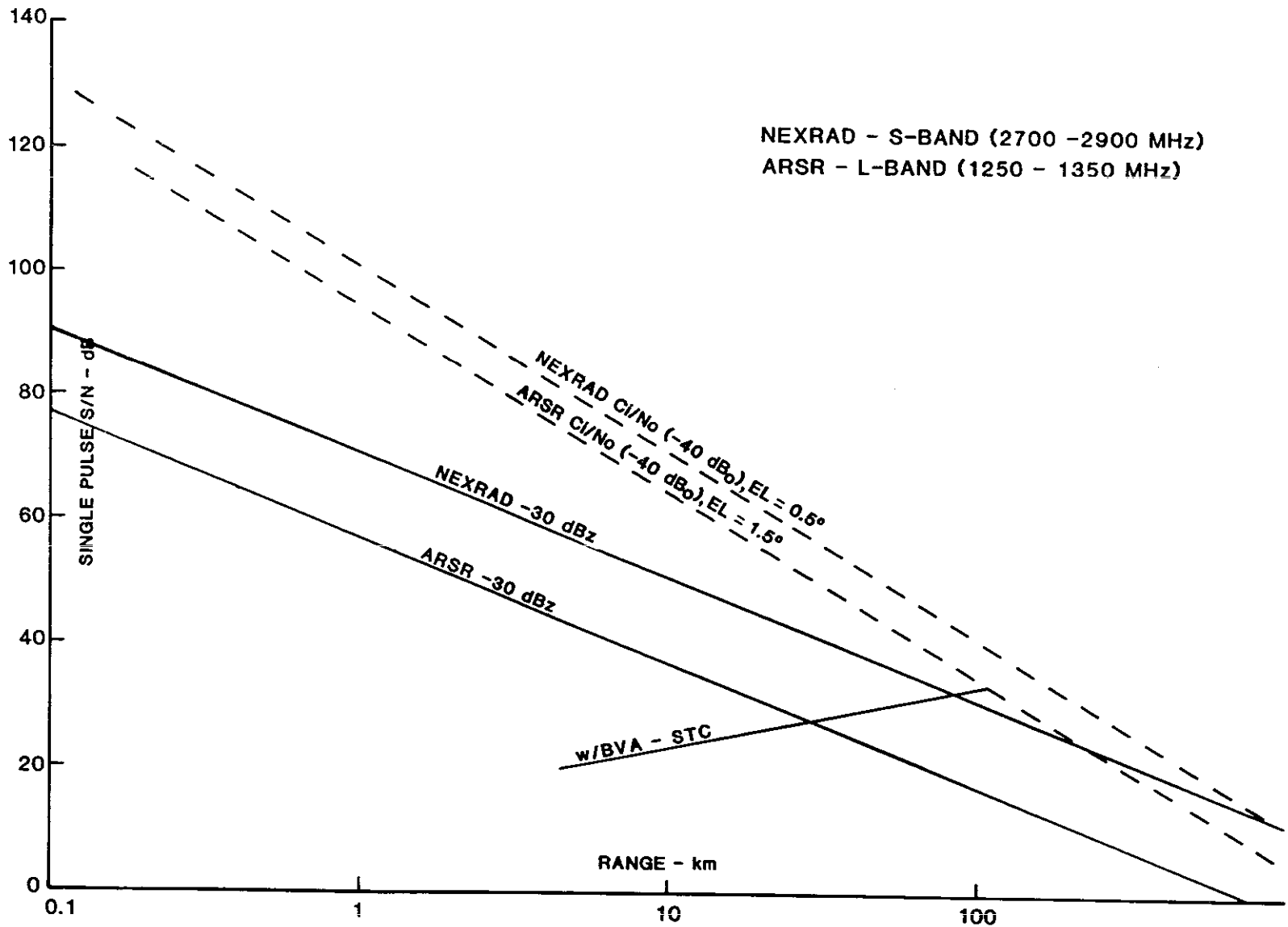

Fig. A-3. Signal-to-noise vs range for weather and ground clutter.

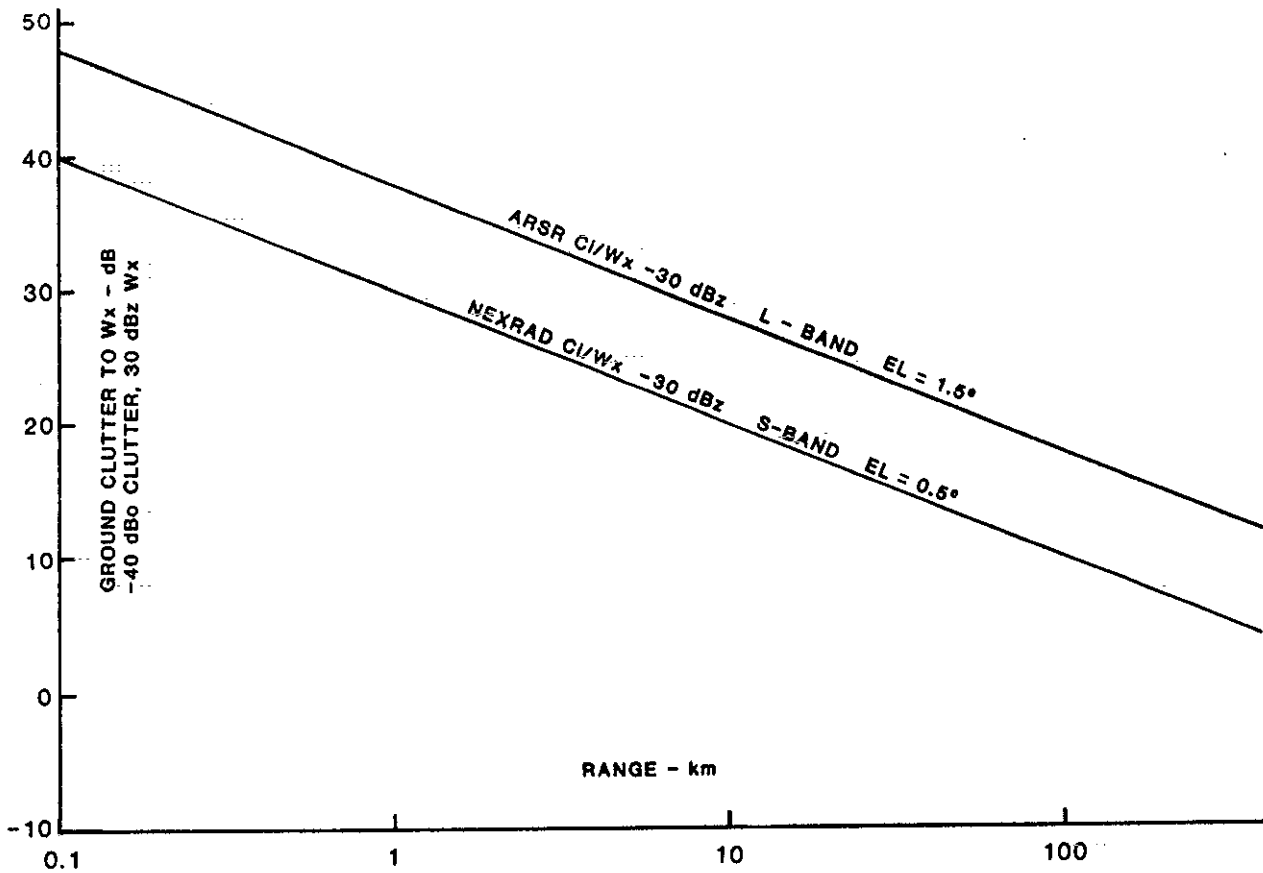

Fig. A-4. Clutter/weather ratios for specific parametric conditions.

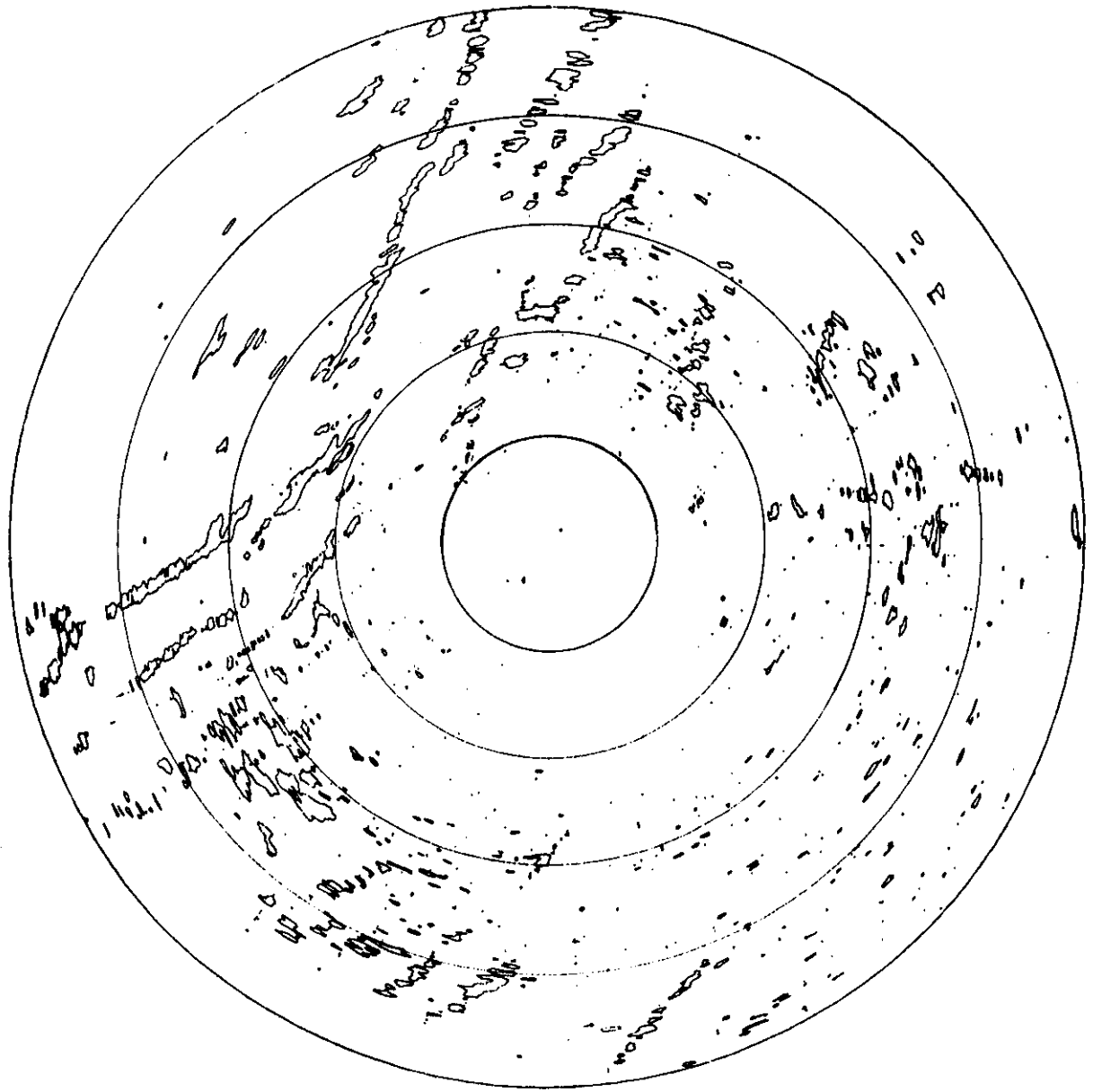

Fig. A-5. Bedford 30 dB clutter 10 nmi range rings.

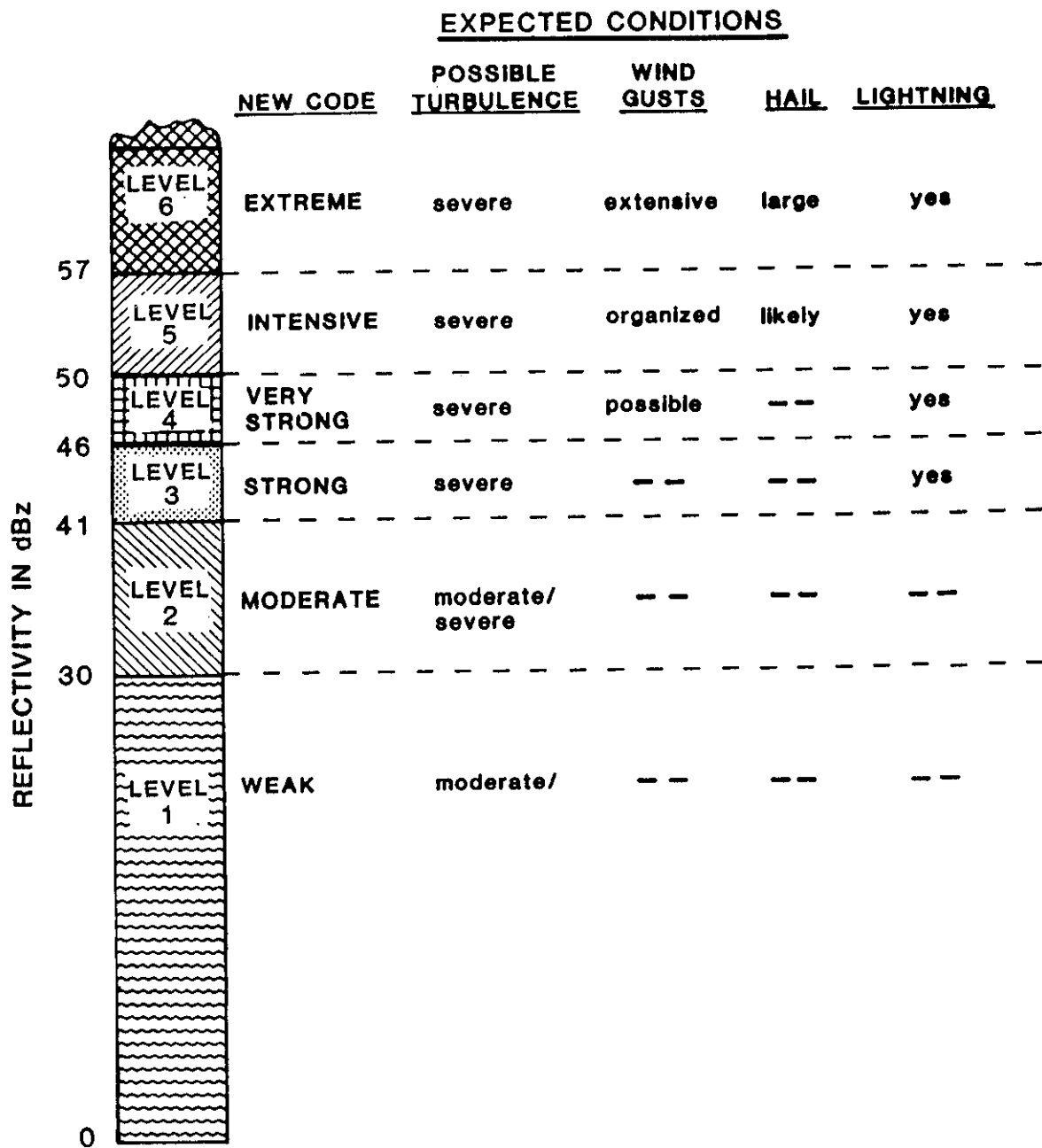

Fig. A-6. Categories of radar Wx echo intensity (as related to NWS levels).

Another feature which should be apparent from the BVA clutter map is that most of the features are small in area compared to typical weather systems, and even though clutter filtering will suppress and distort some weather signals (near zero-velocity), spatial continuity considerations should allow for relatively accurate contouring and smoothing, even for the lowest thresholded level.

Present NWS weather radar systems depend on intervention by trained weather radar meteorologists to identify these features as ground clutter rather than rain, but the ARSR-MTD system will require automated suppression. The NEXRAD system will also suppress ground clutter automatically.

4. ARSR OPERATION

The ARSR-()/MTD, is used for long range (200 nmi) air route surveillance, and uses a sector beam antenna (1.5° azimuth by 5° elevation with CSC² modification) rotating at 30°/sec. (12 seconds per scan). The narrow azimuth beam and high scan rate broaden the ground clutter spectrum, and this complicates the problem of clutter mitigation, since weather spectrum which overlaps must be suppressed as well. The large beam (compared to the NEXRAD 1° pencil beam) will generally not be uniformly filled with hydrometeors (especially at long range) and the estimate of rainfall rate will be low as a consequence. However, for purposes of this treatment, beam-filling is assumed at all ranges.

The radar will be operated in a dual-staggered PRF mode to support MTD processing, with each coherent processing interval (CPI) consisting of at least 8 pulses. Weather will be processed on alternate CPIs. Considerations of weather level estimate variance will be based on 8 pulse CPIs, as presently tested with MTD weather extraction processors. The CPIs will be synchronized in azimuth to support MTD clutter map maintenance, and will permit scan-to-scan smoothing in range-azimuth space. The weather processor will be synchronized with the MTD and probably use the same range gate timing of 1/8 nmi (1.54 μ sec) sampling. Thus, although the separate weather extraction processor is independent of the MTD, there are timing constraints imposed by MTD signalling/processing strategy. The 1.5° elevation angle of the ARSR antenna, used in this discussion, is lower than present systems (normally 2.5° or higher), but would probably be used with MTD processing, since clutter mitigation can be managed, and this gains about 4 dB in sensitivity for long range and low altitude aircraft. It does, of course, impose an additional burden on the weather extraction processor.

5. MULTIPLE TRIP WEATHER ECHOS

One additional problem common to radar measurement methods using relatively high and constant PRF's is that of second-time-around (STA) echoes, arising from longer range targets whose round trip echo time exceeds the interpulse period. For a 1200 PRF characteristic of an ASR, this unambiguous range limit is approximately 68 nmi. Thus, possible weather returns from distant storms in the 90 to 110-nmi range interval, for example, will be superimposed onto desired returns between 20- and 40-nmi range. The resultant reflectivity display can lead to highly erroneous conclusions regarding the actual weather situation. Examples of this on an ASR in Oklahoma are shown in Zittel [7].

Several methods have been suggested for mitigating this problem:

- (1) comparison of the weather display at different PRF's [7],
- (2) recognition of the characteristic elongated shape of STA echos [7],
- (3) use of a low PRF (and appropriate clutter rejection strategy) during periods where STA echos may be present [8], and
- (4) decorrelation of second trip weather returns by use of random phase transmitter changes combined with Doppler filtering [4,7].

The suggested ASR/MTD weather channel was not tested in the experimental programs at FAATC, BVD and BVT; thus STA echos were not a significant factor. However, determining an appropriate combination of hardware features and operational use methods to avoid significant weather interpretation errors should be a key element of the ASR/MTD "weather channel" validation program.

APPENDIX B

CANDIDATE CLUTTER FILTERS

The class of filters which were considered for the weather extraction processor was limited to those which could be realized with the MTD dual-PRF signaling strategy. In all cases, eight resulting samples were to be available after filtering, to support the z-level estimators. The all-pass and mean-level-subtractor (DC-removal filter) were described in Section III, and are essentially trivial. More complex FIR filters were examined, to obtain more or less clutter mitigation, without "totally" eliminating the weather signal. Two 4-pulse (with feedback) cancellors are shown in Figs. B-1 and B-2, and standard 2-pulse and 3-pulse cancellors are shown in Figs. B-3 and B-4. The ASR-MTD high-pass filter response is shown in Fig. B-5 for comparison, but it is not a candidate for this processor.

The filter set used for the example described in Section III of the body of this report was:

<u>Type</u>	<u>Cancellation</u>
0	= 0 dB
1	~-12 dB
2	~-20 dB
3	~-35 dB

For those cells requiring greater clutter mitigation than is possible with these candidate filters, it is recommended that fixed-map censoring be used, as was necessary for some extreme cells at BTV, in the MTD processor.

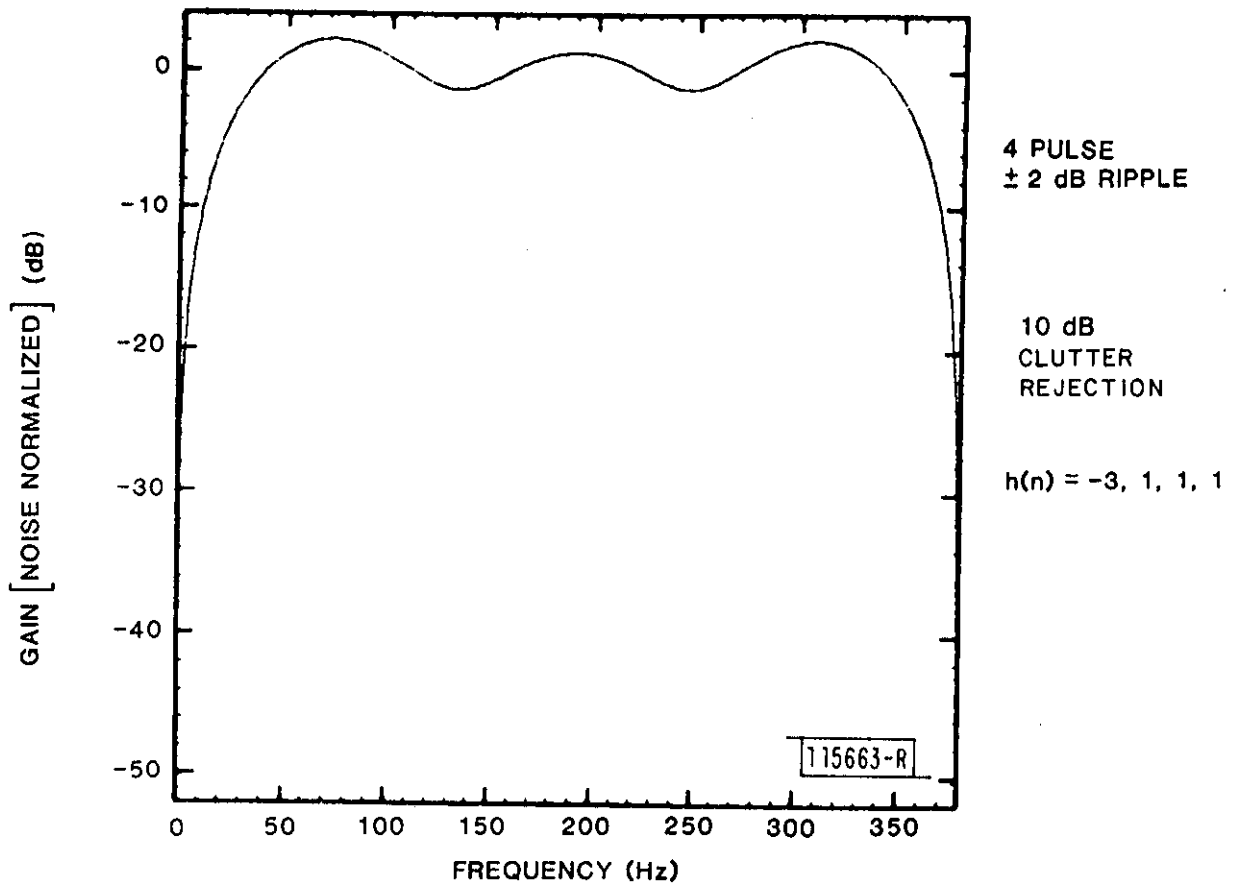

Fig. B-1. 4-pulse equiripple finite impulse response filter.

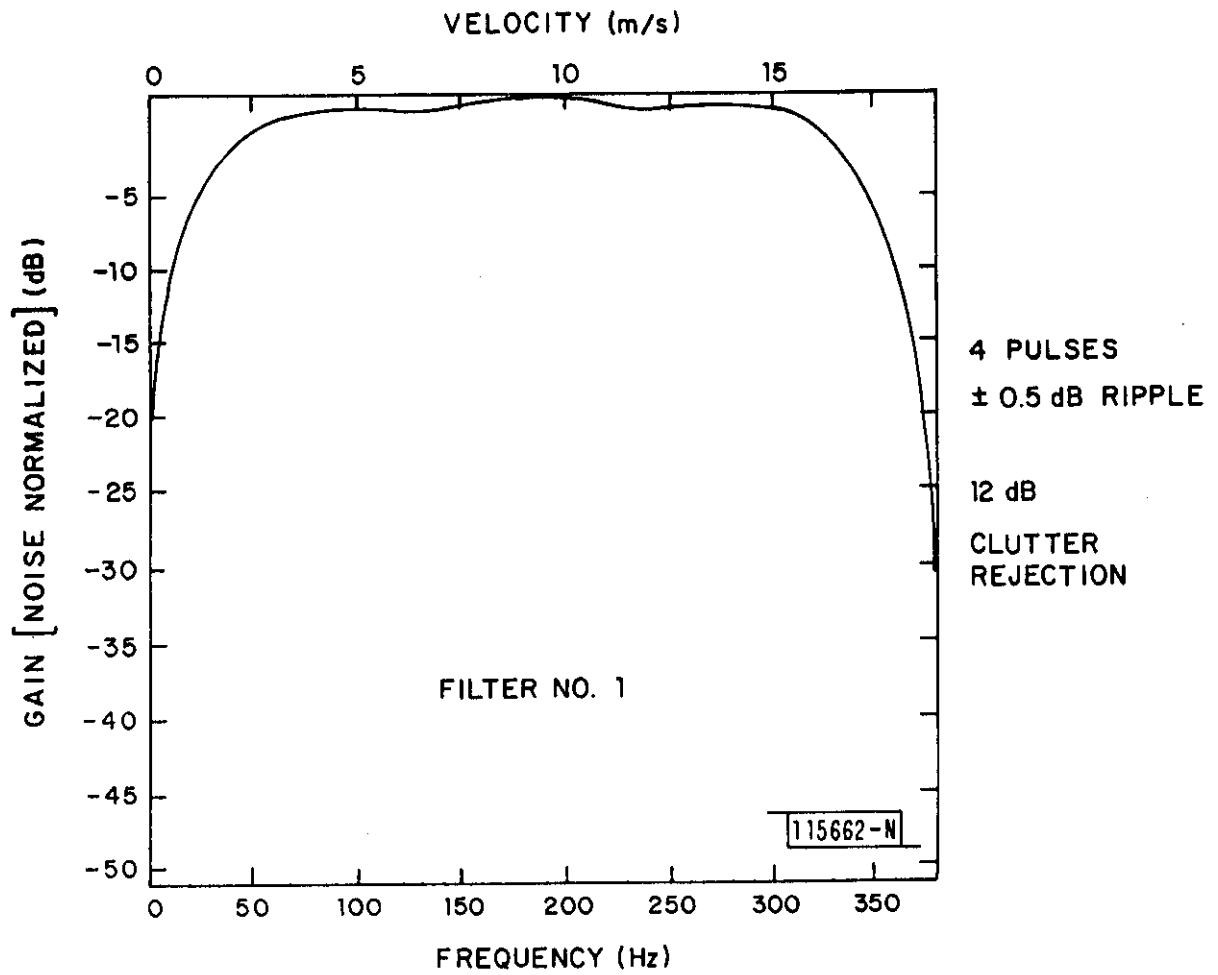

Fig. B-2. 4-pulse equiripple finite impulse response filter.

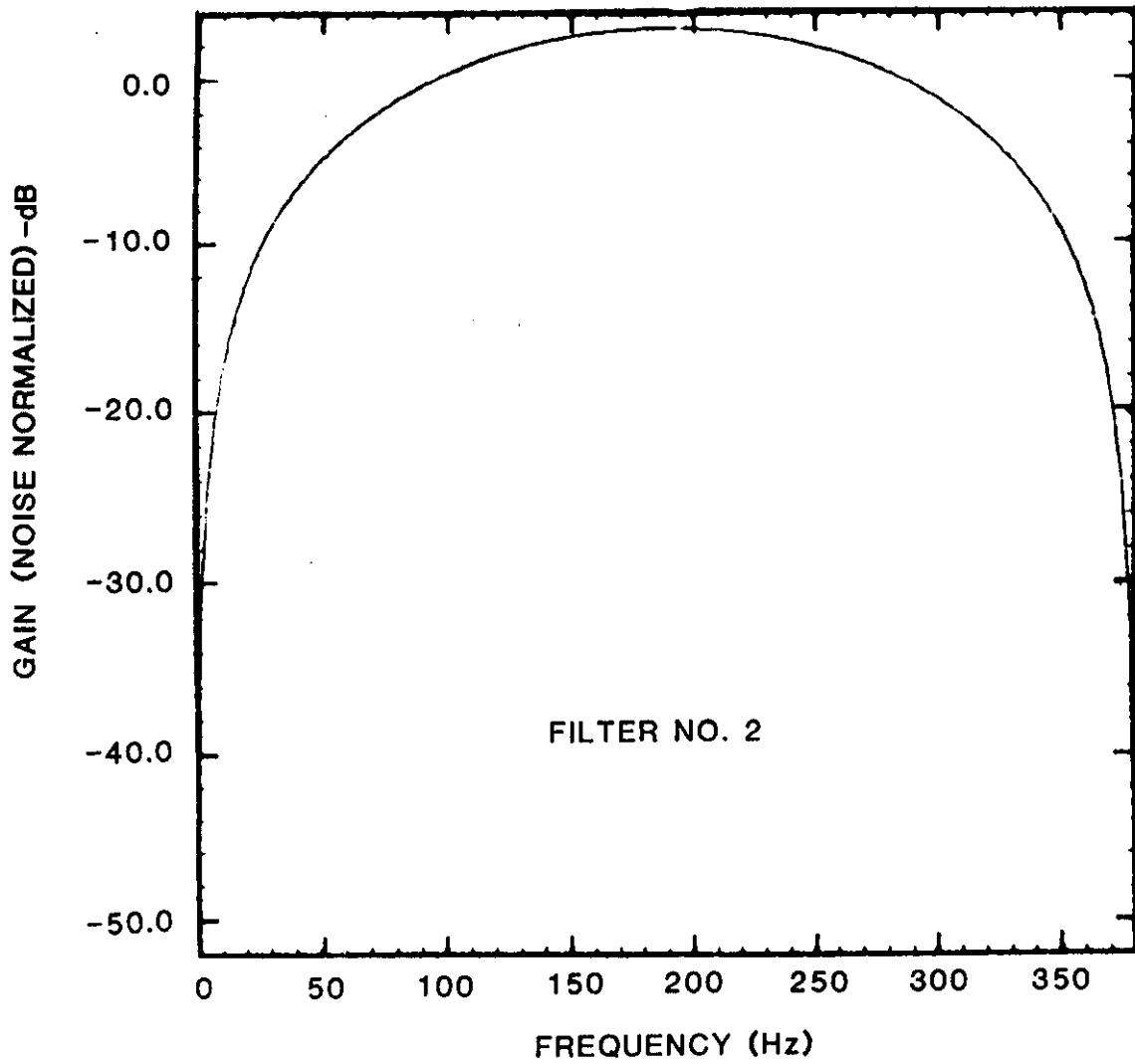

Fig. B-3. Standard 2-pulse canceller.

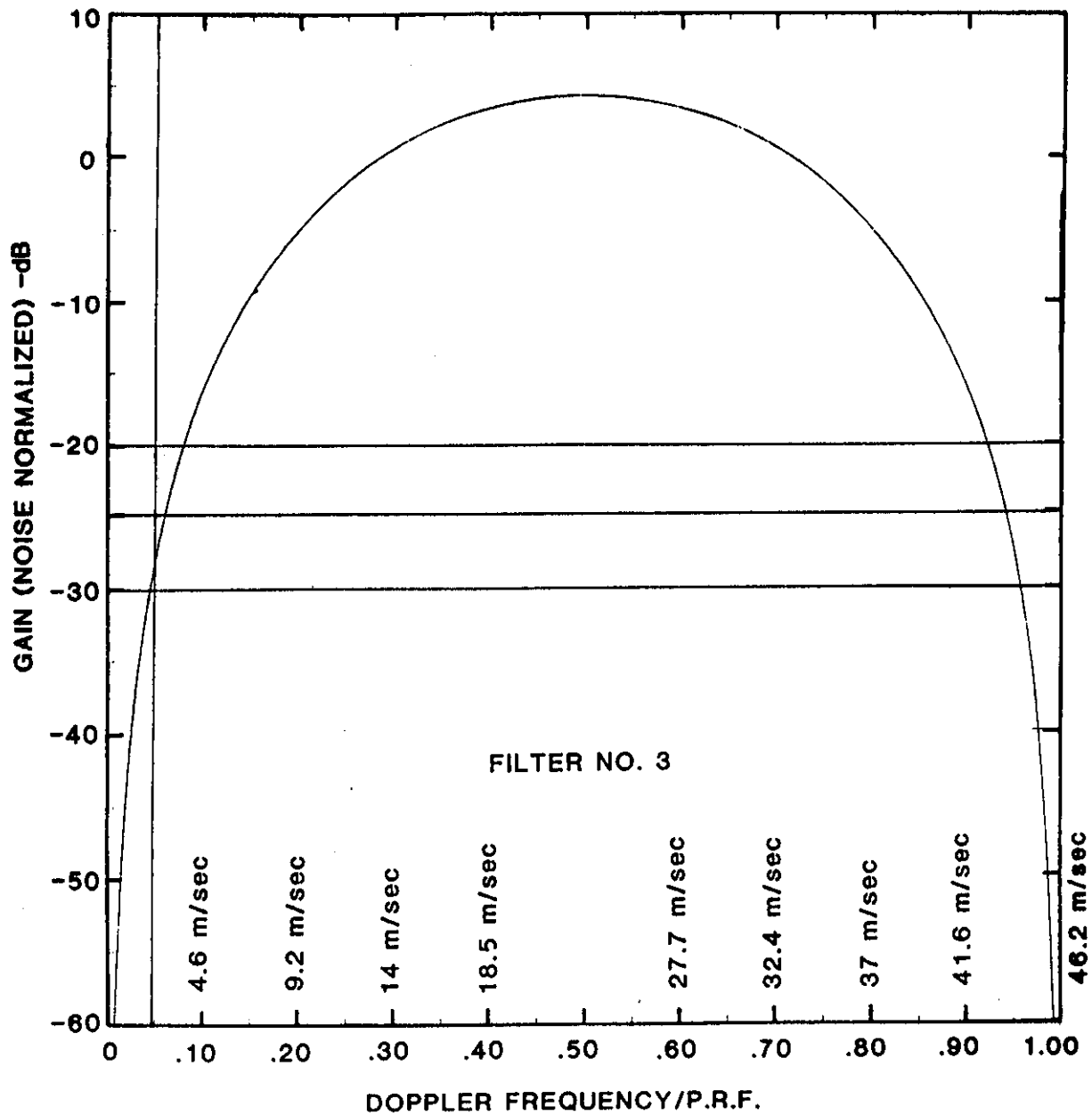

Fig. B-4. Standard 3-pulse canceller.

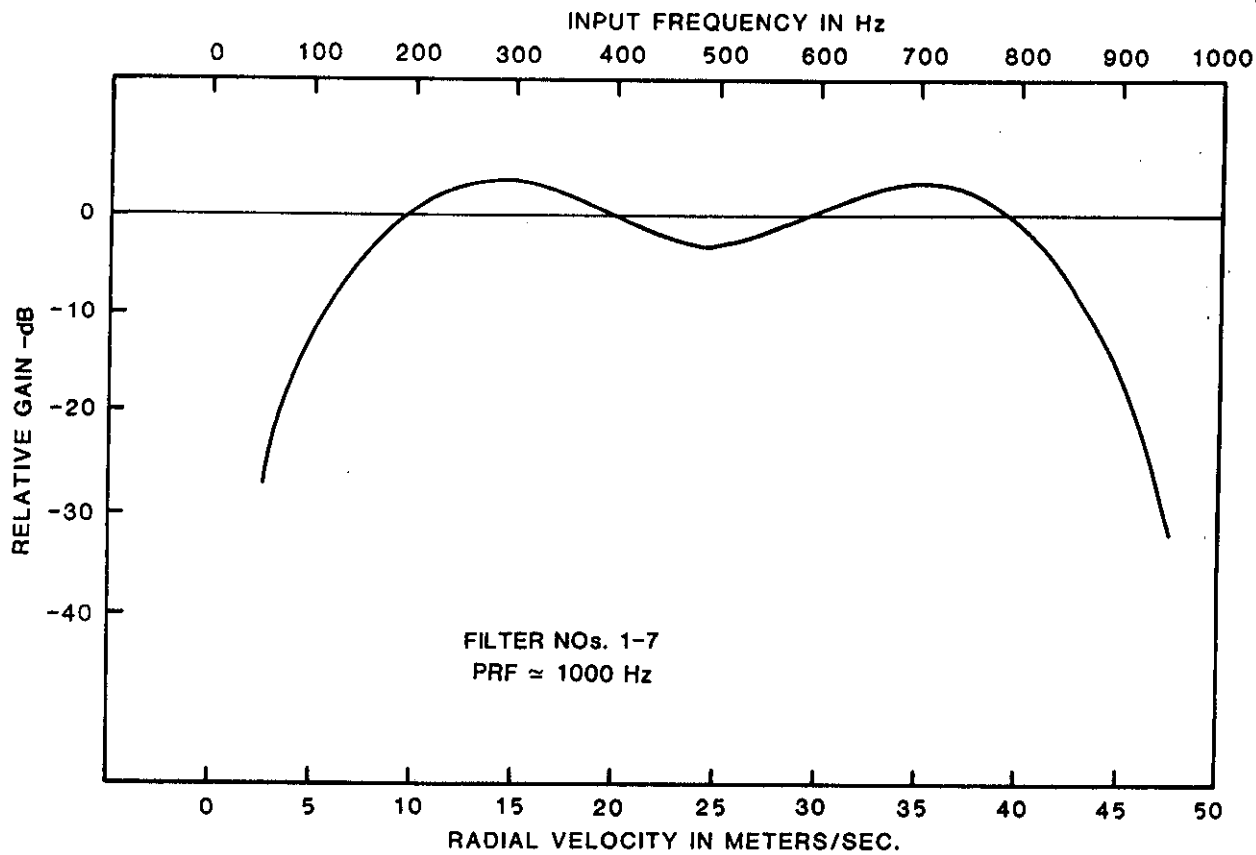

Fig. B-5. ASR-MTD high-pass filter response.

APPENDIX C

LIST OF ACRONYMS AND ABBREVIATIONS

A/C	Aircraft
A/D	Analog-to-Digital
ARSR	Air Route Surveillance Radar
ARTCC	Air Route Traffic Control Center
ASR	Airport Surveillance Radar
ATC	Air Traffic Control
BPF	Band Pass Filter
BVA	Bedford, Virginia
BW	Band Width
CFAR	Constant False Alarm Rate
Ci/No	Ratio of Clutter return in the i-th cell to thermal noise
COHO	Coherent Oscillator
CP	Circular Polarization
CPI	Coherent Processing Interval
dBsm	Decibels with respect to 1.0 sq. meter
dBz	Decibels with respect to radar reflectivity factor, z.
DUP	Duplexer
EL	Elevation (angle)
FAATC	Federal Aviation Administration Technical Center, Atlantic City, NJ
FIR	Finite Impulse Response
GMT	Greenwich Mean Time
IF	Intermediate Frequency
I&Q	In-phase and Quadrature-phase
MTD	Moving Target Detect(or)(ion)
MTI	Moving Target Indicator(ion)
NEXRAD	Designates a hypothetical "next en-route radar design"
NSSL	National Severe Storms Laboratory
NWS	National Weather Service

APPENDIX C (CONT'D)

LIST OF ACRONYMS AND ABBREVIATIONS (CONTINUED)

R/T	Receiver/Transmitter
S/N	Signal-to-Noise Ratio
STALO	Stabilized Local Oscillator
STC	Sensitivity Time Control
WFMU	Weather and Fixed Map Unit
WG	Waveguide
Wx	Weather
Wx/Ci	Ratio of weather return to clutter return in the i-th cell
ZVF	Zero Velocity Filter