

DOT/FAA/NR-92/2

**Project Report  
ATC-186**

# **Summary of Triple Doppler Data Orlando 1991**

**C. F. Keohan  
M. C. Liepins  
C. A. Meuse  
M. M. Wolfson**

**7 April 1992**

---

**Lincoln Laboratory**  
MASSACHUSETTS INSTITUTE OF TECHNOLOGY  
*LEXINGTON, MASSACHUSETTS*



Prepared for the Federal Aviation Administration,  
Washington, D.C. 20591

This document is available to the public through  
the National Technical Information Service,  
Springfield, VA 22161

This document is disseminated under the sponsorship of the Department of Transportation in the interest of information exchange. The United States Government assumes no liability for its contents or use thereof.

1. Report No. ATC-186		2. Government Accession No. DOT/FAA/NR-92/2		3. Recipient's Catalog No.	
4. Title and Subtitle Summary of Triple Doppler Data Orlando 1991				5. Report Date 7 April 1992	
				6. Performing Organization Code	
7. Author(s) C.F. Keohan, M.C. Liepins, C.A. Meuse, and M.M. Wolfson				8. Performing Organization Report No. ATC-186	
9. Performing Organization Name and Address Lincoln Laboratory, MIT P.O. Box 73 Lexington, MA 02173-9108				10. Work Unit No. (TRAVIS)	
				11. Contract or Grant No. DTFA-01-91-Z-02036	
12. Sponsoring Agency Name and Address Department of Transportation Federal Aviation Administration Systems Research and Development Service Washington, DC 20591				13. Type of Report and Period Covered	
				14. Sponsoring Agency Code	
15. Supplementary Notes  This report is based on studies performed at Lincoln Laboratory, a center for research operated by Massachusetts Institute of Technology. The work was sponsored by the Department of the Air Force under Contract F19628-90-C-0002.					
16. Abstract  Under Federal Aviation Administration (FAA) sponsorship, Lincoln Laboratory conducted an aviation weather hazard measurement and operational demonstration program during the summer of 1991 near the Orlando International Airport. Three Doppler radars were sited in a triangle around the airport, allowing triple Doppler coverage of thunderstorms and microbursts occurring there. This report contains a summary of all the microburst-producing thunderstorms that occurred within the triple Doppler region that were scanned in a coordinated fashion, during the months of June, July, August, and September 1991. Statistics on the microburst events are presented to give an overall picture of the available data for use in analysis. The bulk of the report consists of detailed information about each triple Doppler day, including the time, location, and strength of microbursts within the triple Doppler period as well as the availability of data from supporting sensors, including the ASR-9-WSP Doppler radar, radiosondes, LLWAS, Mesonet, AWOS, instrumented aircraft, ACARS, interferometer, and corona points.					
17. Key Words triple Doppler weather radar data three-dimensional wind synthesis thunderstorm data TDWR			18. Distribution Statement  This document is available to the public through the National Technical Information Service, Springfield, VA 22161.		
19. Security Classif. (of this report)  Unclassified		20. Security Classif. (of this page)  Unclassified		21. No. of Pages  152	22. Price

## ABSTRACT

Under Federal Aviation Administration (FAA) sponsorship, Lincoln Laboratory conducted an aviation weather hazard measurement and operational demonstration program during the summer of 1991 near the Orlando International Airport. Three Doppler radars were sited in a triangle around the airport, allowing triple Doppler coverage of thunderstorms and microbursts occurring there. This report contains a summary of all of the microburst producing thunderstorms that occurred within the triple Doppler region that were scanned in a coordinated fashion, during the months of June, July, August, and September, 1991. Statistics on the microburst events are presented to give an overall picture of the available data for use in analysis. The bulk of the report consists of detailed information about each triple Doppler day, including the time, location, and strength of microbursts within the triple Doppler period as well as the availability of data from supporting sensors including the ASR-9-WSP Doppler radar, radiosondes, LLWAS, Mesonet, AWOS, instrumented aircraft, ACARS, interferometer, and corona points.

## ACKNOWLEDGEMENTS

Many people worked very hard to help collect and process the complete dataset described in this report. We gratefully acknowledge Mark Isaminger, Paul Biron, Nat Fischer, Chris Carr, and Stan Dajnak for collecting the TDWR testbed data; Al Borho, Chuck Curtiss, Steve Stock, Pam Borho, and Ron Rinehart for the UND radar data; Earle Williams, Dennis Boccippio, and Oliver Newell for the MIT radar data; Wes Johnston, Jay Laseman, Craig McFarland, Oliver Newell, Bill Moser, and Seth Troxel for the ASR-9 data; Frank Colby, Peter Smith, Vinny Moise, Brian Treanor, and Marc Bennett for the University of Lowell sounding data; Skip Copeland, Chris Carr, Moe Couture, Doug Piercey, and Rod Cole for the Lincoln mesonet data; Bill Drury and Wes Wilson for the LLWAS data; Pierre Laroche, Anne Bondiou, Claire Malherbe, Joel Pigere, Jean Boulay, Phillippe Richard, and Jean-Yves Lejoux for the ONERA SAFIR interferometer data; Earle Williams and Duane Grant for the corona point data; Steve Williams and NCAR for the AWOS data; and Audrine Brown and NOAA for the ACARS data. At Lincoln Laboratory, the data collection plans and analyses have benefitted greatly from the efforts of Rich DeLaura, Bob Hallowell, and Barbara Forman. The data quality editing and tape translations have been tirelessly accomplished by Debbie Diskin, Paul Morin, Janice Williams, Charlie LeBell, and Paul Mitchell. Many other people have contributed to the data collection effort in ways too numerous to mention, and we thank them all. We also thank Mark Weber and Jim Evans for their guidance and suggestions on this report.

## TABLE OF CONTENTS

<u>Section</u>	<u>Page</u>
Abstract	iii
Acknowledgements	v
List of Figures	ix
List of Tables	x
1. INTRODUCTION	1
2. DATA SUMMARY	9
3. TRIPLE DOPPLER CASES	17
SAMPLE INFORMATION SHEET	22
SAMPLE SKETCH	24
15 JUNE 91	25
16 JUNE 91	28
17 JUNE 91	31
18 JUNE 91	34
19 JUNE 91	37
20 JUNE 91	40
21 JUNE 91	43
22 JUNE 91	46
23 JUNE 91	49
24 JUNE 91	52
25 JUNE 91	55
23 JULY 91	58
28 JULY 91	61
29 JULY 91	65
31 JULY 91	68
2 AUGUST 91	71
5 AUGUST 91	74
9 AUGUST 91	78
10 AUGUST 91	82
12 AUGUST 91	86
15 AUGUST 91	89
19 AUGUST 91	92
24 AUGUST 91	95
25 AUGUST 91	98
30 AUGUST 91	101
31 AUGUST 91	104
7 SEPTEMBER 91	107
10 SEPTEMBER 91	111

16 SEPTEMBER 91	115
20 SEPTEMBER 91	117
21 SEPTEMBER 91	122
22 SEPTEMBER 91	125
25 SEPTEMBER 91	128
29 SEPTEMBER 91	131
4. SUMMARY	135
APPENDIX A: CORONA POINT STATION – SENSOR ASSOCIATION	137
LIST OF ABBREVIATIONS	139
REFERENCES	141

## LIST OF FIGURES

<u>Figure</u>		<u>Page</u>
1	Map showing the 1991 TDWR, UND, and MIT C-band Doppler radar locations in Orlando.	2
2	Contours of vertical velocity error (m/s) at 1 km AGL (left) and 16 km AGL (right) using the most favorable wind synthesis method in each case.	3
3	Illustration of 2.5 min volume update rate TDWR scan.	4
4	As in Fig. 3, but for the 3 min volume update “Scientific” scan.	5
5	Locations of the Lincoln Laboratory Mesonet stations (diamonds) and the FAA LLWAS stations (Xs) around the Orlando International Airport in 1991.	7
6	As in Fig. 5, except 1991 corona point station locations (diamonds) are shown.	8
7	Histogram of triple Doppler microburst events in Orlando, 1991.	10
8	Histogram of microburst maximum differential wind speed for all triple Doppler microburst events as determined from TDWR Doppler signature.	11
9	Location of triple Doppler microburst events during June, 1991.	12
10	Location of triple Doppler microburst events during July, 1991.	13
11	Location of triple Doppler microburst events during August, 1991.	14
12	Location of triple Doppler microburst events during September, 1991.	15



## LIST OF TABLES

<u>Table</u>		<u>Page</u>
1	Summary of all triple Doppler microburst events observed in Orlando, 1991.	18
2	Checklist of supporting sensor data available for triple Doppler cases.	21
A-1	Association between corona point stations (locations shown in Fig. 6) and the individual corona point sensors, by date.	138

## 1. INTRODUCTION

The Federal Aviation Administration (FAA) Terminal Doppler Weather Radar (TDWR) and Airport Surveillance Radar (ASR-9) program offices sponsored an aviation weather hazard measurement and operational demonstration program during the summer of 1991 near the Orlando International Airport, principally to test and refine techniques for the automatic detection of low-altitude wind shear phenomena [1, 2]. The FAA Integrated Terminal Weather System (ITWS) program contributed to the measurement effort to develop a data-base of "true" three dimensional winds in thunderstorms. By integrating data from several operational terminal area and aircraft sensors and by utilizing sophisticated computational techniques for processing single Doppler weather radar data, ITWS will be able to provide detailed three dimensional winds in the terminal area. The FAA Terminal Area Surveillance System (TASS) program also contributed to the measurement effort to develop a data-base of thunderstorm phenomena using rapid update scans and full volume coverage. The TASS program is intended to develop aircraft and weather surveillance systems for the 21st century; electronically scanned phased-array radars are under consideration as a means for providing rapid update data on fast-evolving thunderstorms.

Three Doppler weather radars were sited in a triangular configuration, each located about 6 mi from the Orlando airport, to provide full volume coverage of thunderstorms and microbursts occurring at the airport. With three Doppler radars, the full three dimensional wind field in a storm can be unambiguously recovered [3, 4, 5]. The radars, shown in Fig. 1, included the Terminal Doppler Weather Radar C-band testbed (TDWR), the University of North Dakota C-band Doppler radar (UND), and the Massachusetts Institute of Technology C-band Doppler radar (MIT).

The region in which three dimensional winds can accurately be synthesized at all altitudes lies within the triangle defined by the radar locations (Fig. 2). Each radar scanned a sector  $80^{\circ}$ - $120^{\circ}$  wide over this "triple Doppler region". The elevation angle scan strategy for the three radars during June and July was dictated by the TDWR operational hazardous weather scan. The volume update rate was 2.5 min, and the beam elevation angles that were scanned are illustrated in Fig. 3. The TDWR scan emphasizes measurements of low altitude phenomena, so the coverage is more dense below 5 km. During August and September, a 3 min volume update rate was employed with more evenly spaced beams. This is illustrated in Fig. 4. If the storms developed before they entered the triple Doppler region, the MIT radar was often able to provide rapid update rate RHI scans to document the thunderstorm evolution.

The supporting sensor data available in Orlando included data from a Lincoln operated Airport Surveillance Radar (ASR-9) with the Wind Shear Processor (WSP) add-on, special thermodynamic soundings, occasional instrumented aircraft data, LLWAS (Low Level Wind Shear Alert System) and Mesonet data, Automated Weather Observing System (AWOS) data, lightning data from the SAFIR interferometer system deployed by the French government laboratory ONERA, and cloud electrical activity data from an array of corona points. In addition, the NOAA Forecast Systems Laboratory (FSL) recorded and supplied Lincoln Laboratory with ACARS (Aircraft Communications Addressing and Reporting Service) data from commercial jets throughout the country via the ARINC (Aeronautical Radio, Inc.) Company.

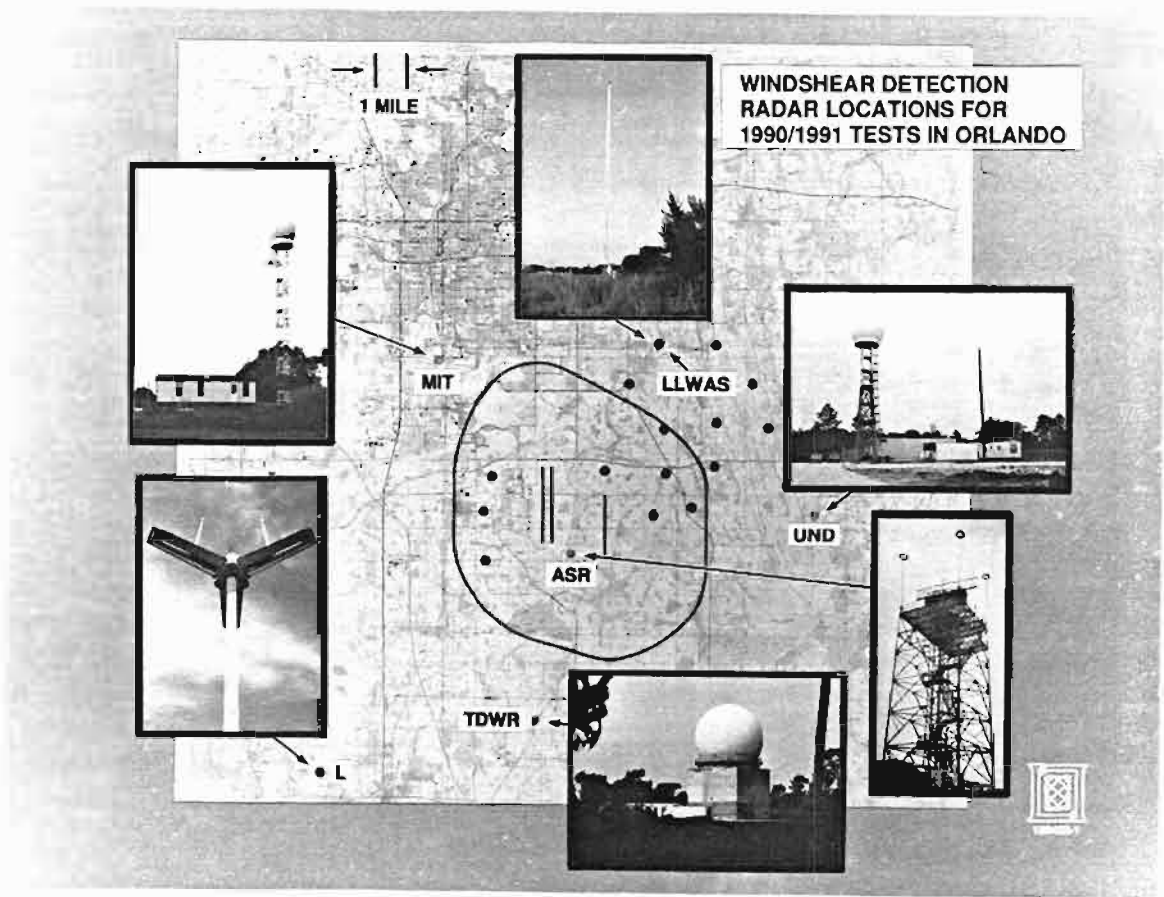

Figure 1. Map showing the 1991 TDWR, UND, and MIT C-band Doppler radar locations in Orlando. The Orlando International airport runways are shown as 3 north-south oriented lines near the center of the map, and the region of TDWR coverage is shown by the roughly circular black outline around the airport. Lincoln Laboratory also operated a wind shear processor add-on to the FAA Airport Surveillance Radar (ASR), and a network of automatic weather stations shown as black spots labelled LLWAS (for Low Level Wind Shear Alert System; data from the FAA LLWAS around the airport was recorded but those stations are not shown on this map). The SAFIR interferometer system for measuring lightning is shown in the lower left corner (L).

The Lincoln operated ASR-9 scanned a full 360° once every 4.8 s with its dual fan-beam antenna. This radar provided a measure of thunderstorm reflectivity that is proportional to vertically integrated liquid water content and, by using sophisticated signal processing techniques [6, 7], the Doppler velocity at low altitude as well. The radiosondes, launched by University of Massachusetts at Lowell personnel at the UND radar site, measured winds (via cross-chain LORAN tracking), temperature, and dew point as a function of pressure

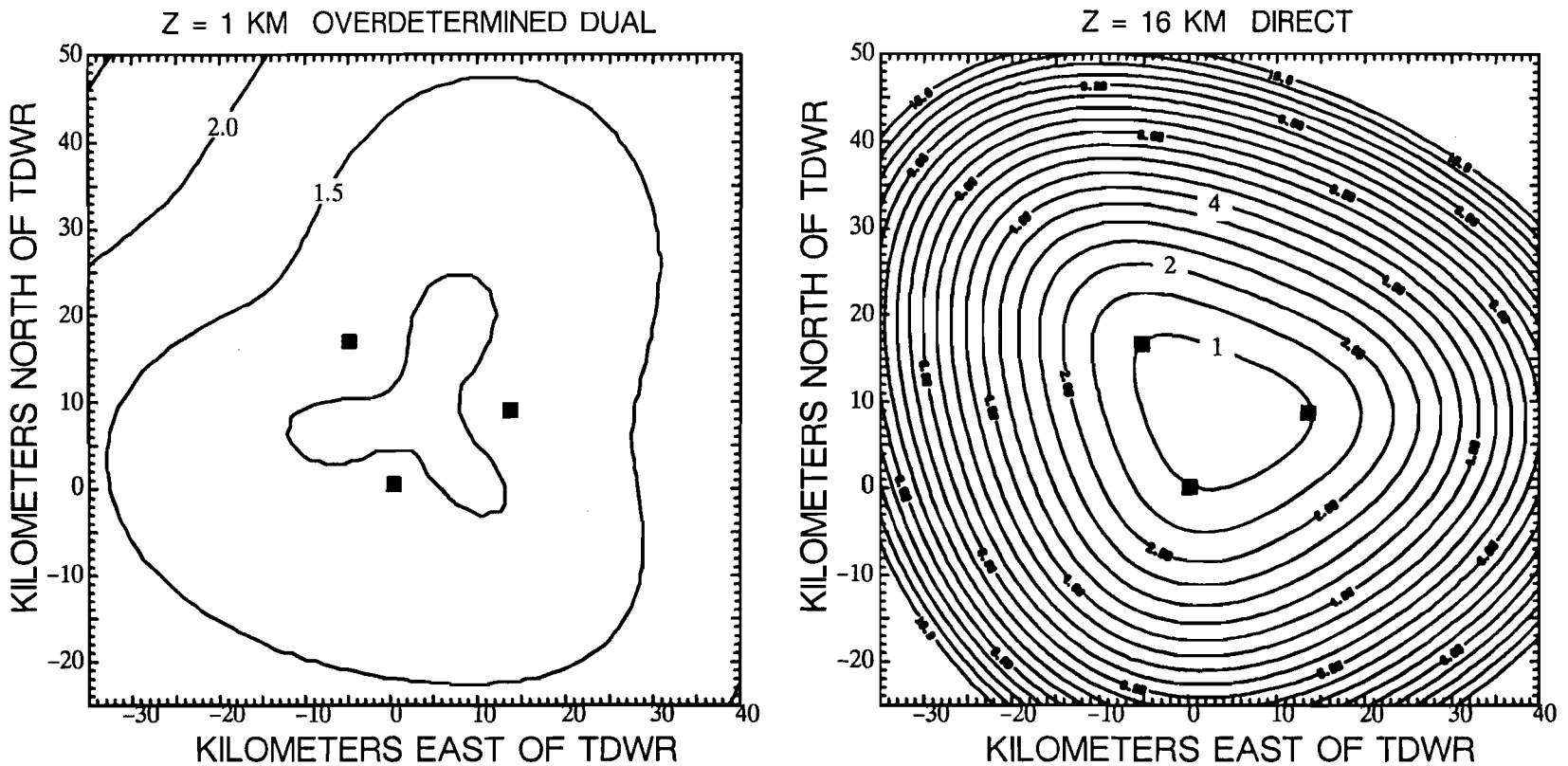

Figure 2. Contours of vertical velocity error (m/s) at 1 km AGL (left) and 16 km AGL (right) using the most favorable wind synthesis method in each case. The errors are calculated assuming that each radar has an inherent error of 1 m/s in its Doppler measurement. The common region of low error coverage lies within the triangle defined by the three Doppler radars (TDWR, MIT, and UND).

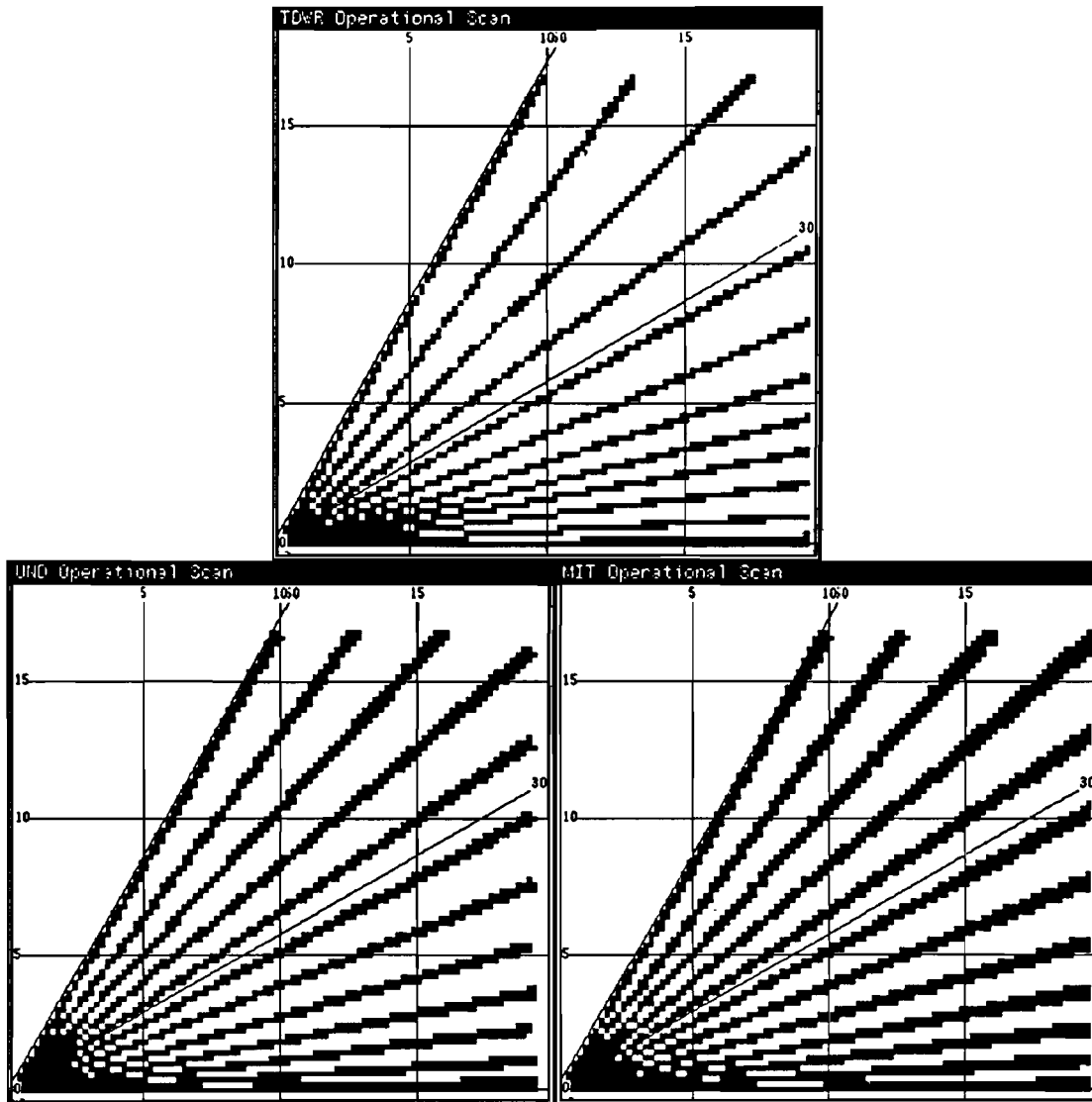

Figure 3. Illustration of 2.5 min volume update rate TDWR scan. The TDWR testbed radar is shown on top with a  $0.5^\circ$  beamwidth, UND is shown in the lower left with a  $1^\circ$  beamwidth, and MIT is shown in the lower right with a  $1.4^\circ$  beamwidth. In each frame, the radar is located in the lower left corner and the dark "beams" represent the 3dB radar coverage. The scale is indicated by the overlying grid with labels at 5, 10, and 15 km. Lines representing the  $30^\circ$  and  $60^\circ$  elevation angles are also shown.

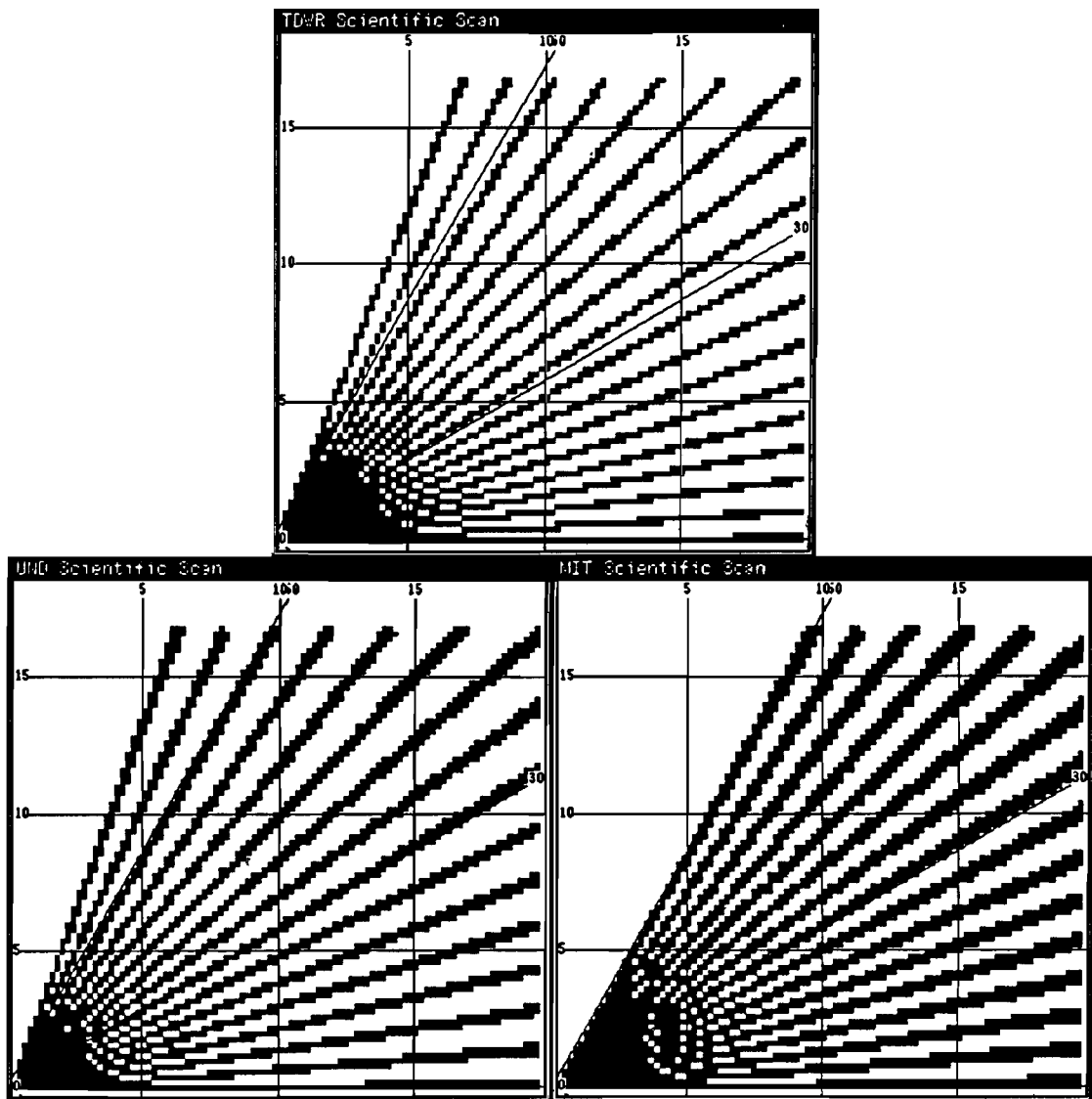

Figure 4. As in Fig. 3, but for the 3 min volume update "Scientific" scan.

altitude within the atmosphere. The soundings were launched at 3 hour intervals and took approximately 1 hour to complete. One instrumented aircraft was a B737 flown by NASA Langley Research Center at Orlando from June 10th through 20th. The aircraft was instrumented with reactive (accelerometer-based) and forward-looking wind shear detection systems. The forward-looking systems included both passive infrared and Doppler radar systems. The Westinghouse BAC1-11 aircraft was also on site during August, but no microburst penetrations with triple Doppler coverage were performed. The LLWAS stations operated by the FAA measured wind speed and direction every 10 s with sensors mounted on poles of varying height according to the degree of sheltering at each site. To supplement the LLWAS measurements, Lincoln Laboratory operated a 15 station Mesonet, which measured wind speed and direction every 10 s with sensors mounted on 100' towers, and temperature and relative humidity every minute with sensors mounted approximately 6' above ground level in a vane aspirator. A map of the LLWAS and Mesonet stations is shown in Fig. 5. Data were also recorded from the FAA AWOS system at the Kissimmee airport, west of the TDWR radar site. A personal computer belonging to NCAR was located on-site to record the data. (Since NCAR was participating in the CaPE scientific experiment at Cape Canaveral during July and August, they also wanted to collect available supporting data.) The AWOS measured wind speed and direction, temperature, dew point, precipitation, pressure (and altimeter setting), ceiling/sky condition, and visibility every minute. The SAFIR interferometer consisted of two remote antenna systems that were used to detect and locate VHF noise from lightning [8], with a time resolution of 100  $\mu$ s. A network of 13 corona points was used to monitor the polarity of the surface electric field and lightning activity within 10-15 km of the sensors, with a sampling rate of 1 Hz. The corona point station locations are shown in Fig. 6. Since different corona point sensors could be physically located on the same corona point station (*e.g.*, when a malfunctioning sensor had to be replaced), Appendix A lists each corona point station, its associated sensors, and the dates of the association. Finally, ACARS data were recorded by NOAA FSL in Boulder and supplied to Lincoln for every period in which triple Doppler measurements were made. These data include wind speed and direction from the onboard INS, ambient temperature, and aircraft location (latitude, longitude, and altitude).

This report contains a summary of all of the thunderstorms that occurred within the triple Doppler region and that were scanned in a coordinated fashion during the months of June, July, August, and September, 1991. Statistics on the microburst events are presented in the following chapter, and individual information sheets for each triple Doppler day are presented in Chapter 3. Chapter 2 is designed to present an overall picture of the available data for use in analysis; it contains charts describing the location, wind speed distribution, and frequency of events over the entire period. Chapter 3 gives detailed information about each triple Doppler day (some days have more than one triple Doppler period), including the time, location, and strength of microburst events within the triple Doppler period as well as the availability of data from the supporting sensors including ASR-9 radar, aircraft, radiosondes, LLWAS, Mesonet, AWOS, interferometer, corona points, and ACARS. Chapter 4 gives a brief summary and information for readers who wish to request data described in this report.

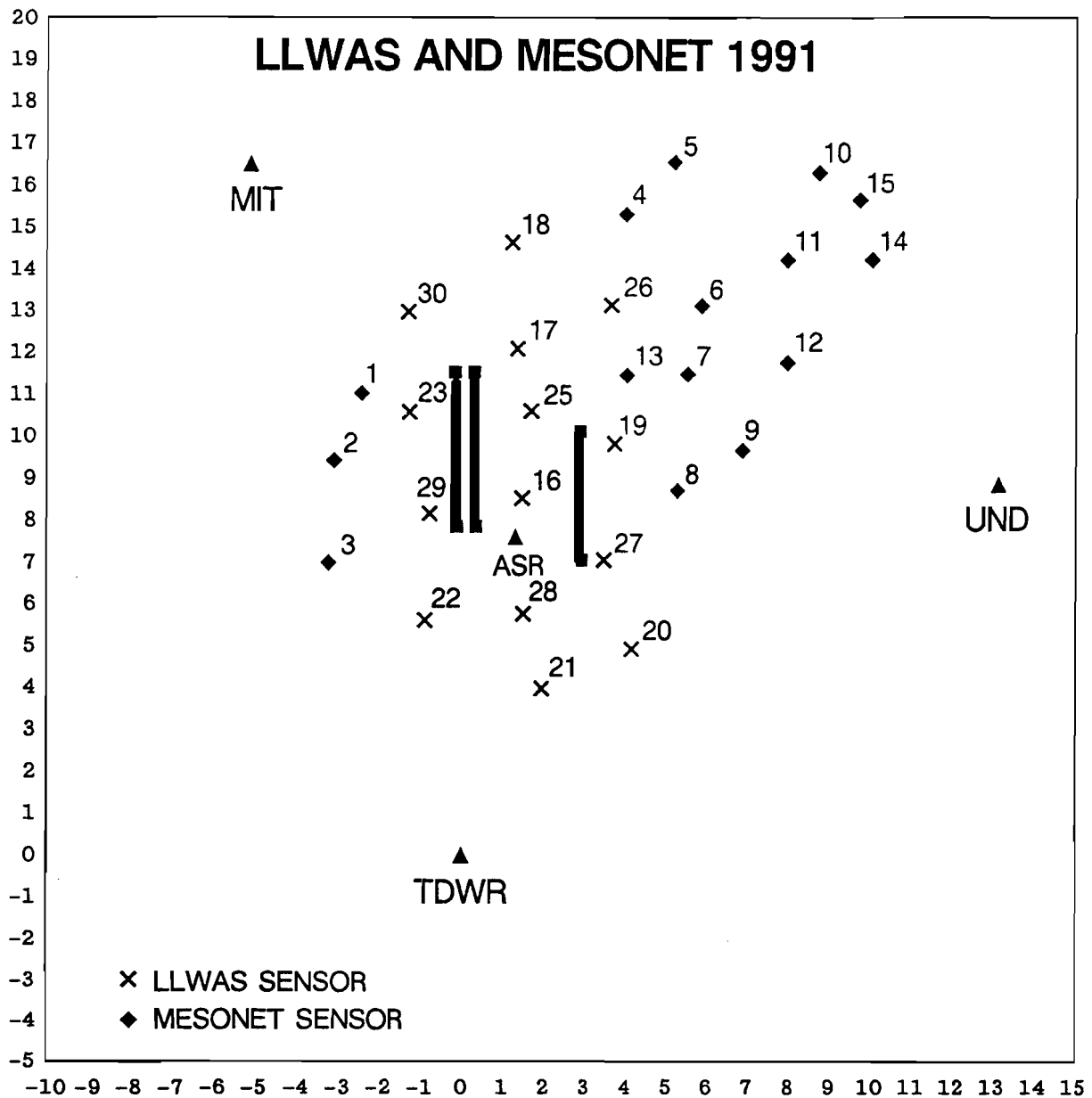

Figure 5. Locations of the Lincoln Laboratory Mesonet stations (diamonds) and the FAA LLWAS stations (Xs) around the Orlando International Airport in 1991. Each LLWAS and Mesonet station is given an identifying number, shown next to the station location mark. The airport runways are shown as three thick black lines in the center of the chart, and the TDWR, MIT, and UND radar locations are shown as triangles.



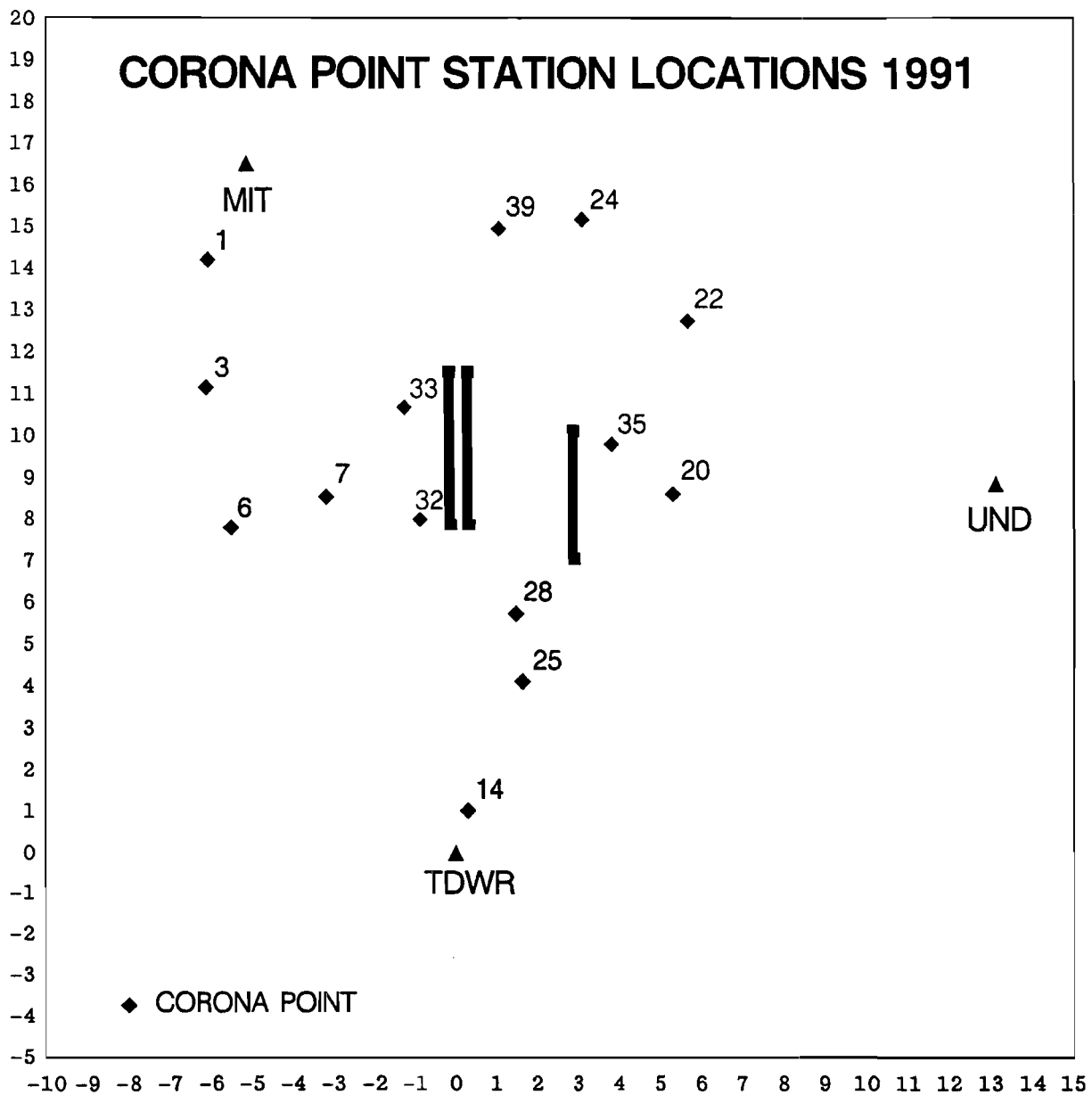

Figure 6. As in Fig. 5, except 1991 corona point station locations (diamonds) are shown. Each corona point station is given an identifying number, shown next to the station location mark.

## 2. DATA SUMMARY

This chapter describes the triple Doppler data set in general. Figure 7 summarizes the number of microburst events per day during the entire data collection period. A total of 60 events were observed over the summer. Events for which instrumented aircraft data are available are indicated by dark shading. The MIT radar was struck by lightning on June 26, and did not return to service until July 24. Two or more events were recorded on most triple Doppler days because new storms often formed adjacent to old ones, and the storm systems themselves were generally slowly translating.

Figure 8 shows the distribution of maximum outflow differential wind speed in the triple Doppler microbursts, as determined from the TDWR Doppler radar only. Microbursts of widely varying strengths were recorded, ranging from the operational threshold of 10 m/s up to 45 m/s (August 9, 1991). The August 9 event ranks as one of the most severe microbursts ever recorded with the TDWR testbed radar.

Figures 9 through 12 show the monthly locations, respectively, of triple Doppler microbursts. The markers are placed where the microburst outflow reached its maximum. When the marker is shaded, it indicates that the complete life cycle of the microburst was observed with triple Doppler coverage. In this report, the region of triple Doppler coverage is defined as the area within the triangle created by connecting the three radars. Complete life cycle includes the first echo growth, but in many cases mature storms were already present and the new "first echo" represented the continued development of a discretely propagating multicell storm. Complete life cycle coverage is available for 41 events, including the 45 m/s microburst on August 9. Very few triple Doppler events were recorded in July only because the MIT radar was down (Fig. 10); the daily thunderstorm frequency was at its peak during this period. The thunderstorm frequency died off rapidly in September, explaining the small number of events shown in Fig. 12.

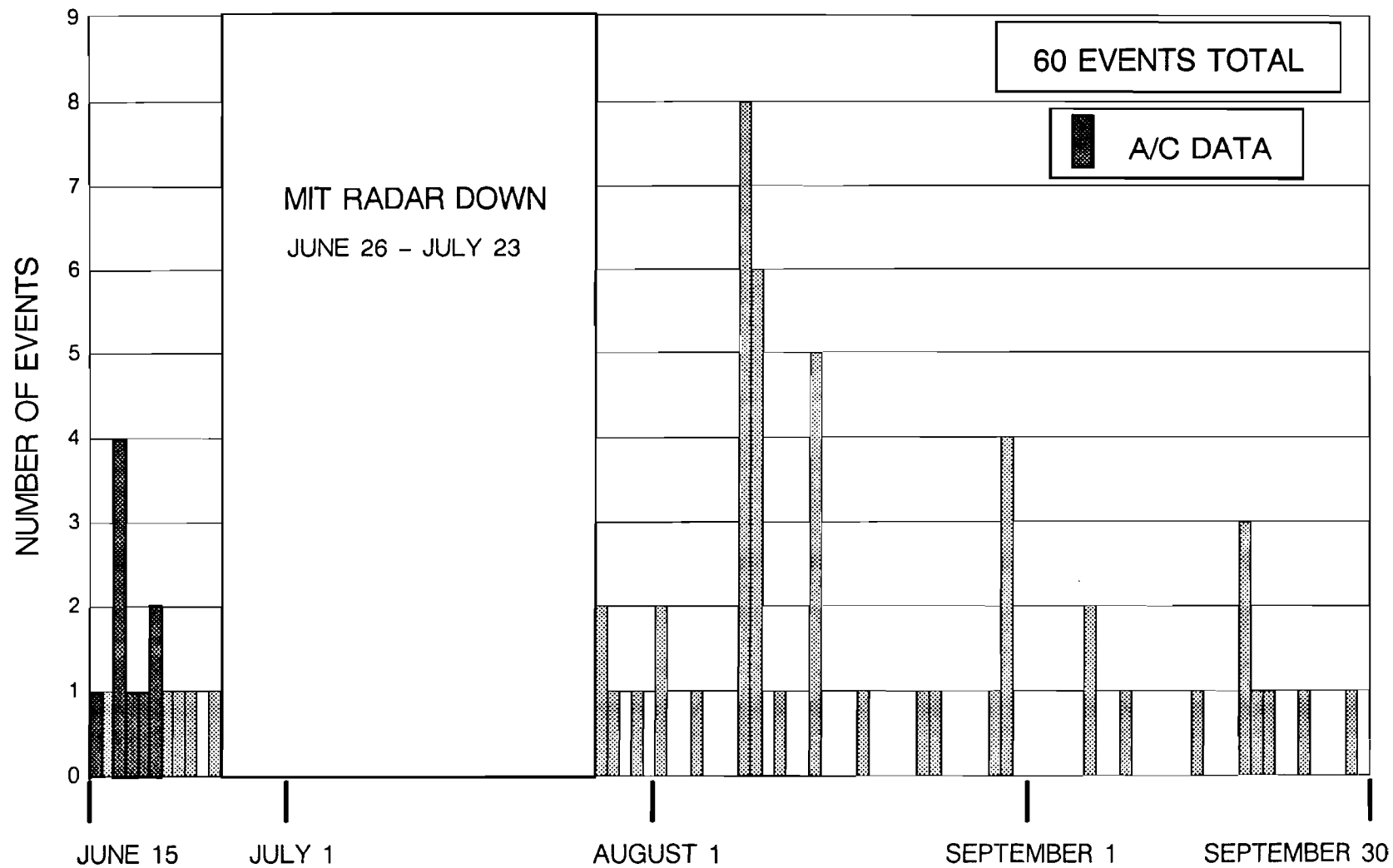

Figure 7. Histogram of triple Doppler microburst events in Orlando, 1991. A total of 60 events were observed.

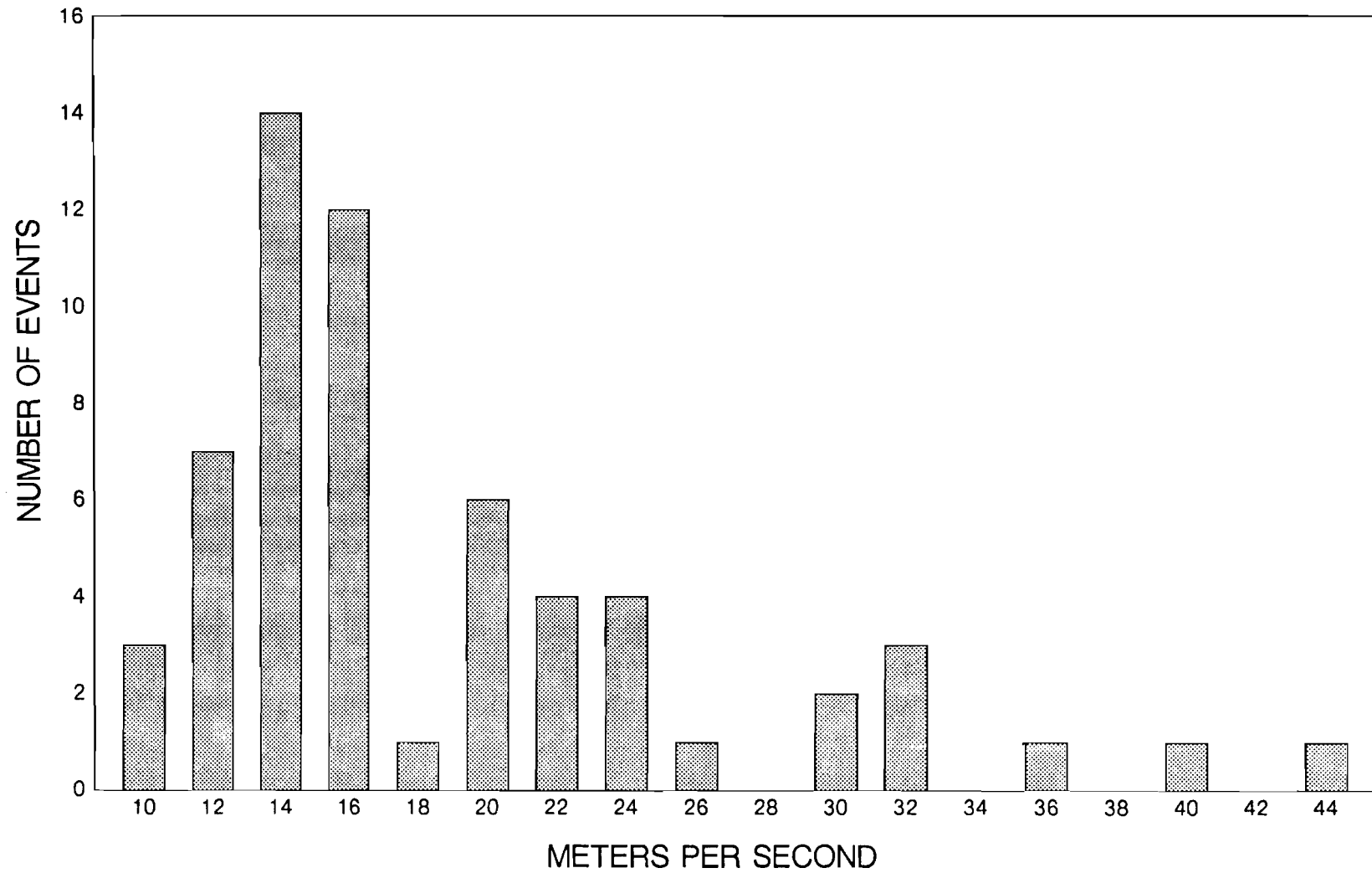

Figure 8. Histogram of microburst maximum differential wind speed for all triple Doppler microburst events as determined from TDWR Doppler signature.

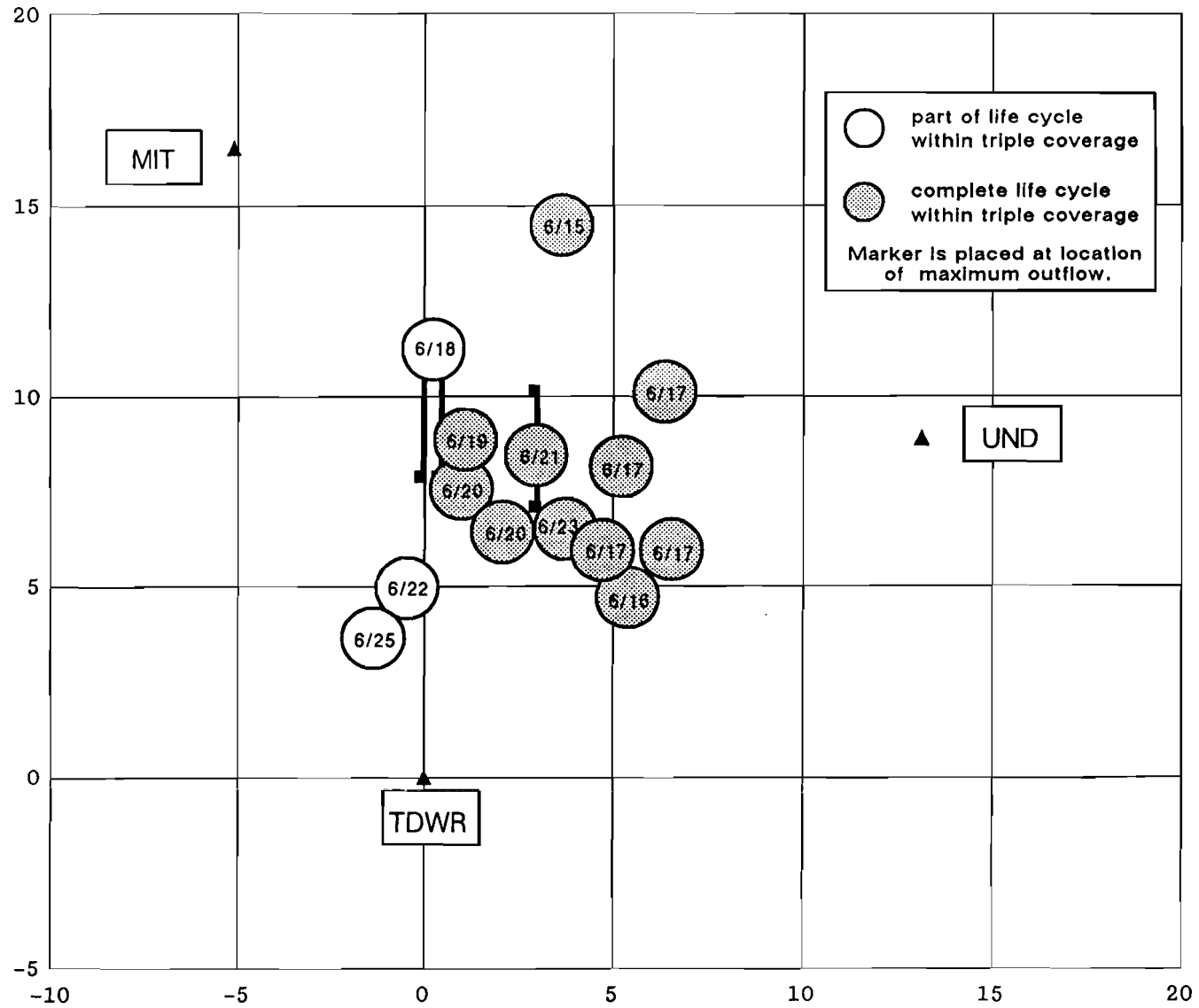

Figure 9. Location of triple Doppler microburst events during June, 1991.

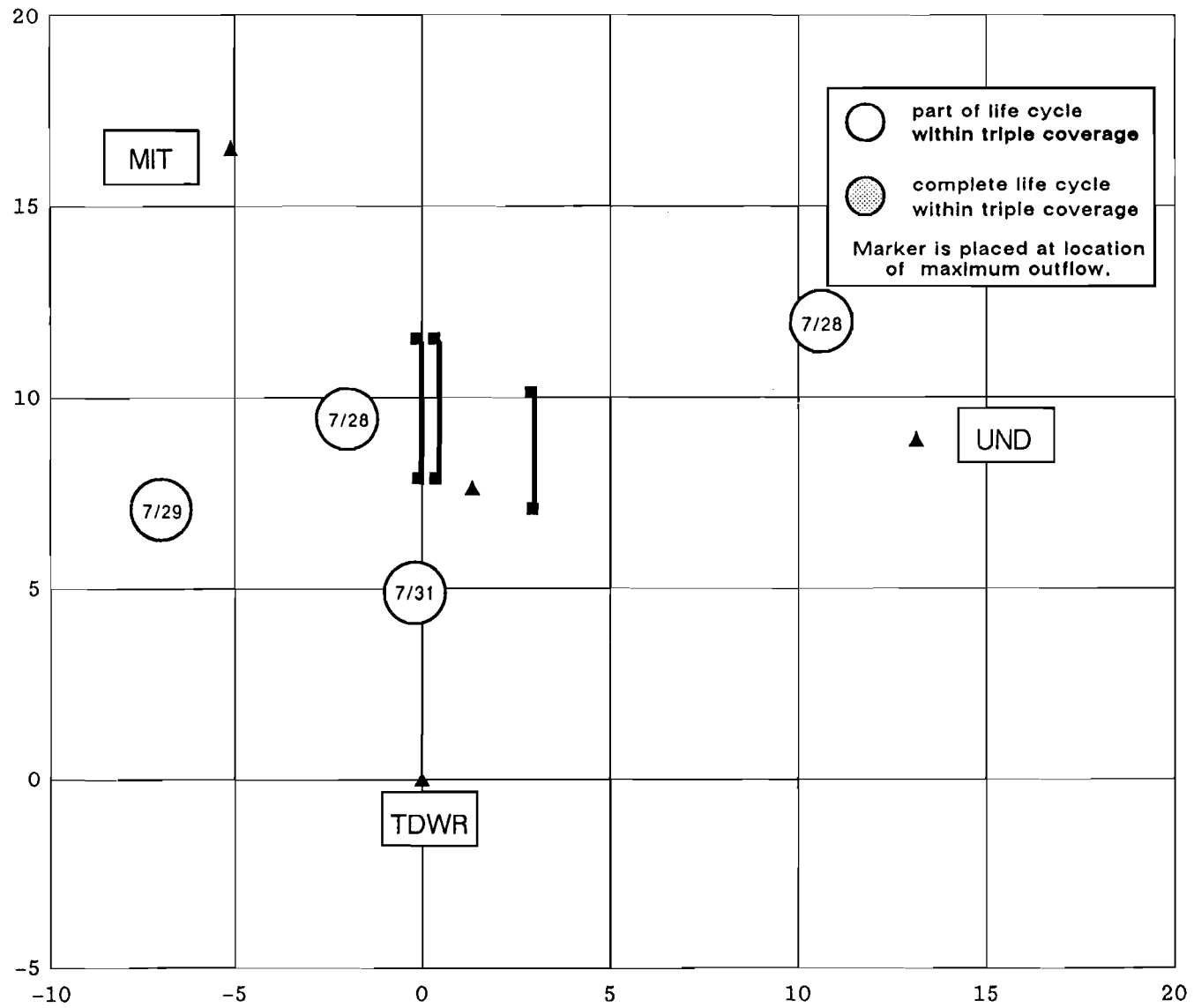

Figure 10. Location of triple Doppler microburst events during July, 1991.



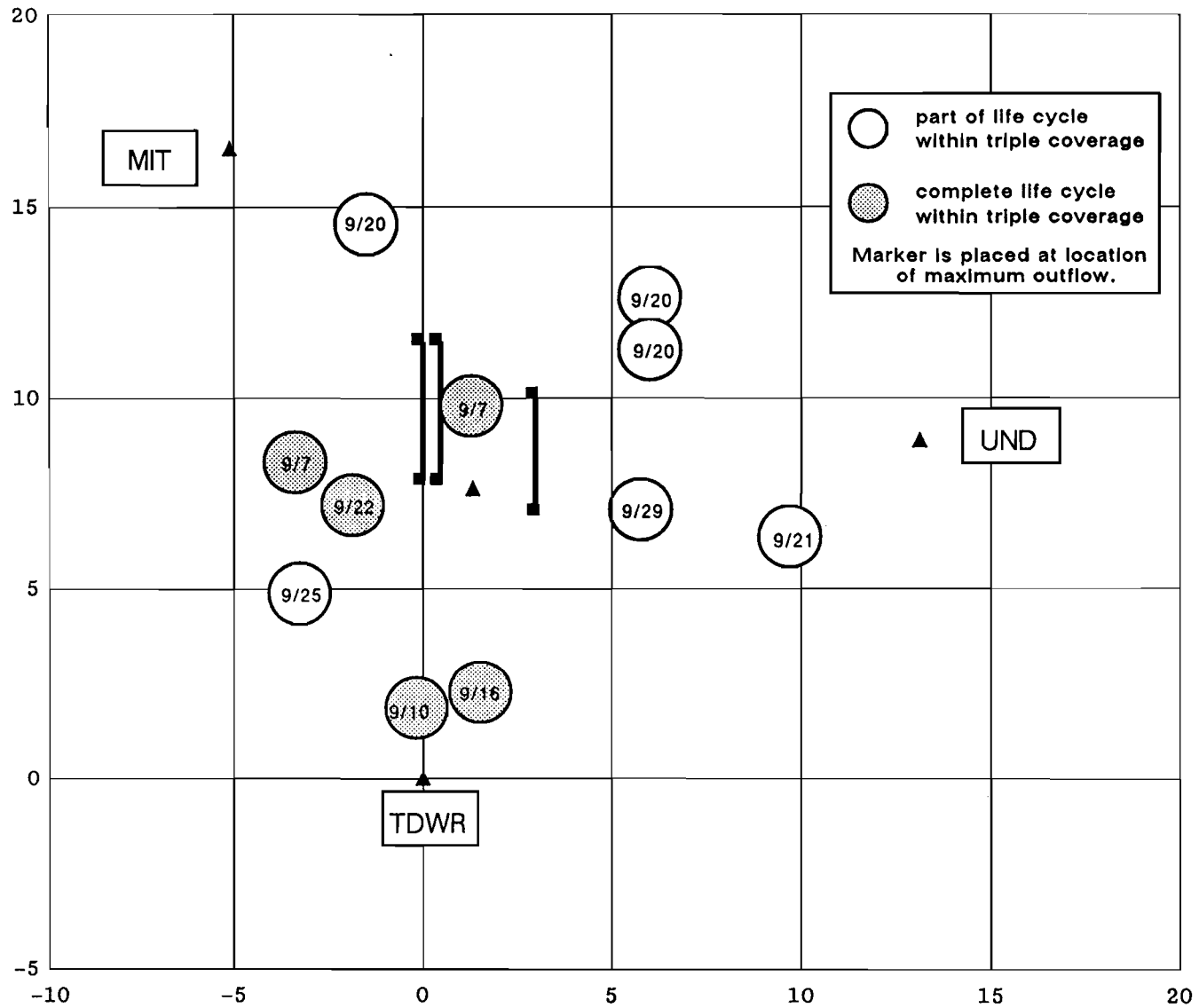

Figure 12. Location of triple Doppler microburst events during September, 1991.



### 3. TRIPLE DOPPLER CASES

In this chapter, detailed information about each triple Doppler day is given. Table 1 gives a complete summary of all the microburst events for which triple Doppler coverage is available, and includes the location of the event relative to the TDWR testbed radar, the maximum differential outflow velocity recorded by that radar, and a notation as to whether the entire life cycle of the storm was recorded. Table 2 gives a summary of all of the supporting sensor data available for each triple Doppler day.

The rest of this chapter consists of detailed information about each triple Doppler day in the form of an Information Sheet detailing the available supporting data and the radar coverage, and a Sketch depicting the storm(s) in plan view and vertical cross-section format. To illustrate the use of the Information Sheet and Sketches, samples explaining them are first given.

**Table 1. Summary of all triple Doppler microburst events observed in Orlando, 1991. Location is relative to TDWR testbed radar.**

DATE	TIME OF MAXIMUM OUTFLOW ( UT )	LOCATION OF MAXIMUM OUTFLOW ( range / azimuth )	MAXIMUM DIFFERENTIAL VELOCITY ( m/s )	ENTIRE CELL HISTORY
June 15	1954	15 / 013	14	✓
June 16	2258	07 / 049	37	✓
June 17	1859	08 / 038	15	✓
	1909	12 / 032	20	✓
	1914	10 / 031	24	✓
	1915	09 / 048	17	✓
June 18	2047	11 / 003	14	
June 19	1716	09 / 007	22	✓
June 20	2118	07 / 017	14	✓
	2123	08 / 006	24	✓
June 21	2054	09 / 017	12	✓
June 22	2209	05 / 355	13	
June 23	2357	08 / 031	17	✓
June 25	1935	04 / 342	21	
July 28	2233	16 / 041	14	
	0017	10 / 349	12	
July 29	2347	10 / 313	33	
July 31	1740	05 / 357	11	
August 2	2116	10 / 019	14	
	2130	20 / 026	17	

**Table 1 (continued). Summary of all triple Doppler microburst events observed in Orlando, 1991. Location is relative to TDWR testbed radar.**

DATE	TIME OF MAXIMUM OUTFLOW ( UT )	LOCATION OF MAXIMUM OUTFLOW ( range / azimuth )	MAXIMUM DIFFERENTIAL VELOCITY ( m/s )	ENTIRE CELL HISTORY
August 5	1755	14 / 037	14	
August 9	1931	12 / 353	40	✓
	1943	08 / 017	45	✓
	1944	05 / 020	21	✓
	1945	09 / 019	16	✓
	1947	06 / 011	31	✓
	1951	05 / 059	27	✓
	1958	07 / 049	30	✓
	1959	09 / 068	20	✓
August 10	2059	11 / 024	16	✓
	2101	14 / 015	32	✓
	2105	13 / 028	20	✓
	2111	16 / 029	17	✓
	2114	14 / 051	14	✓
	2238	07 / 040	23	✓
August 12	2253	17 / 006	17	
August 15	1944	07 / 349	17	✓
	1948	13 / 034	12	✓
	1952	09 / 356	22	✓
	1952	08 / 020	21	✓

**Table 1 (continued). Summary of all triple Doppler microburst events observed in Orlando, 1991. Location is relative to TDWR testbed radar.**

DATE	TIME OF MAXIMUM OUTFLOW ( UT )	LOCATION OF MAXIMUM OUTFLOW ( range / azimuth )	MAXIMUM DIFFERENTIAL VELOCITY ( m/s )	ENTIRE CELL HISTORY
	2003	09 / 030	22	✓
August 19	1839	06 / 355	14	
August 24	1859	06 / 315	14	
August 25	2215	13 / 049	11	✓
August 30	1741	07 / 020	12	✓
August 31	2032	11 / 019	24	✓
	2049	09 / 359	25	✓
	2055	08 / 341	14	✓
	2058	10 / 327	33	✓
September 7	2047	09 / 337	16	✓
	2047	10 / 006	14	✓
September 10	1817	02 / 351	16	✓
September 16	1756	03 / 029	14	✓
September 20	1906	14 / 025	14	
	1909	13 / 028	16	
	2340	15 / 354	16	
September 21	1740	12 / 057	10	
September 22	1716	08 / 347	12	✓
September 25	1755	06 / 326	18	
September 29	1615	09 / 038	12	

**Table 2. Checklist of supporting sensor data available for triple Doppler cases. Lightning data refers to SAFIR interferometer data.**

DATE	AIRCRAFT DATA	SAFIR LIGHTNING DATA	MESONET DATA	CORONA POINT DATA	ACARS DATA	AWOS DATA	ASR-WSP DATA
June 15	✓				✓	✓	✓
June 16					✓	✓	✓
June 17	✓				✓	✓	✓
June 18	✓			✓	✓	✓	✓
June 19	✓			✓	✓	✓	✓
June 20	✓			✓	✓	✓	✓
June 21					✓	✓	✓
June 22				✓	✓	✓	✓
June 23				✓	✓	✓	✓
June 25				✓	✓	✓	✓
July 28			✓		✓	✓	✓
July 29			✓	✓	✓	✓	✓
July 31			✓	✓	✓	✓	✓
August 2			✓	✓	✓	✓	✓
August 5			✓	✓	✓	✓	✓
August 9			✓	✓	✓	✓	✓
August 10			✓	✓	✓		✓
August 12			✓	✓	✓	✓	✓
August 15					✓	✓	✓
August 19				✓	✓	✓	✓
August 24	data not in			✓	✓	✓	
August 25	data not in		✓	✓	✓	✓	
August 30	data not in		✓	✓	✓	✓	✓
August 31			✓	✓	✓	✓	✓
September 7			✓		✓	✓	
September 10			✓		✓	✓	
September 16			not processed		✓	✓	✓
September 20		✓	not processed	✓	✓	✓	
September 21		✓	not processed		✓	✓	
September 22		✓	not processed	✓	✓	✓	
September 25		✓	not processed		✓	✓	✓
September 29		✓	not processed	✓	✓	✓	

## SAMPLE INFORMATION SHEET

**Description:** The weather during the triple Doppler period is described, including the storm scenario and the sounding characteristics (winds aloft, surface temperature and dew point, and lifted condensation level [indicates cloud base]). Wind speeds are classified as light (0 – 10 mph), moderate (11 – 25 mph), and strong (26 – 50 mph). All altitudes are given in m or km AGL.

The accompanying sketch is also described. The storm which produces the largest microburst during the period, and has good triple coverage is typically sketched. Where room permits, other cells may also be included.

All times referred to on the information sheets and accompanying sketches are in GMT.

**Triple Doppler Times:** Time period(s) Radars

**Total Coverage Times:** Time period, Radar

The complete period of operation for each radar for the given day.

**Site Observations:** Event (max  $\Delta V$ ) time of max  $\Delta V$  (location) MCO symbol(s)  
where event is MB or GF  
max  $\Delta V$  is in m/s  
time is that of max  $\Delta V$   
location of max  $\Delta V$  in the form (range/azimuth) relative to TDWR  
MCO notation for those events that impacted the airport  
symbol  $\blacktriangledown$  is for an event considered to be a good triple Doppler case  
symbol  $\uparrow$  is for an event which is shown in the accompanying sketch page.

**Dual Doppler Times:** Time period(s) Radars

**RHI Scans:** Radar  
Time period, direction

List of the time period and general direction of RHI scans for each radar during the total Doppler coverage period.

**ASR-WSP data:** Time period(s)

**Sounding Times:** List of the time of each sounding for the day.

**Aircraft data:** Yes, brief description and time period or None.

**ACARS data:** Yes or None.

**Mesonet and LLWAS data:** Triple Doppler time period

Station#	% good	Station #	% good
.	.	.	.

The mesonet data summary is presented for each triple Doppler time period separately. Station numbers (Station#) are displayed in the standard format currently in use where stations 1–15 are mesonet, 16–24 are nine station LLWAS and 25–30 are six station LLWAS. The locations of all the stations are shown in Fig. 5. “% good” refers to the percentage of good data over the entire triple Doppler time period. No distinction is made between bad and missing data. Station statistics are calculated from preprocessed mesonet and LLWAS data; therefore additional data may be available. No data have been processed after September 9, 1991, but may be available upon request.

**AWOS data:** Yes or None.

**Interferometer data:** Yes, time period for lightning data collection or None.

**Corona point data:** Triple Doppler time period.  
Corona point sensors listed as C#.

Appendix A gives the association between corona point sensors and corona point stations throughout the data collection period. The corona point station locations are shown in Fig. 6.

# SAMPLE SKETCH

DATE

TDWR Surface Scans.

T0 = time of beginning of triple period

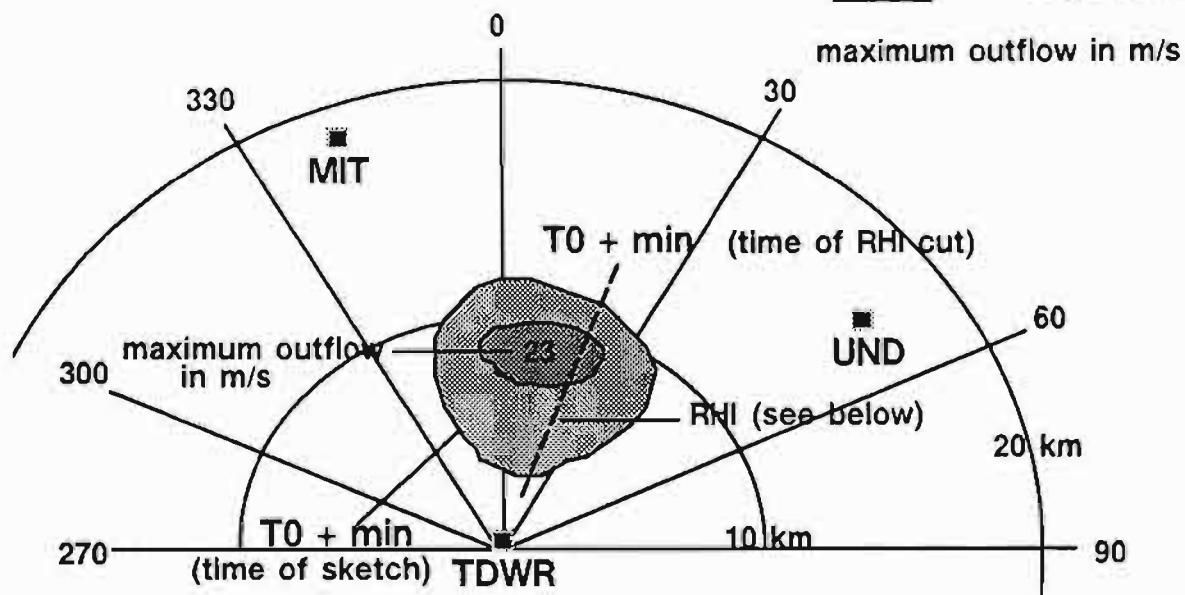
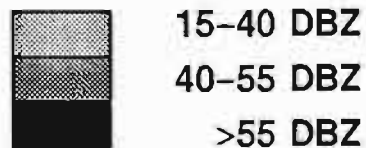

RHI plots from above dashed lines.

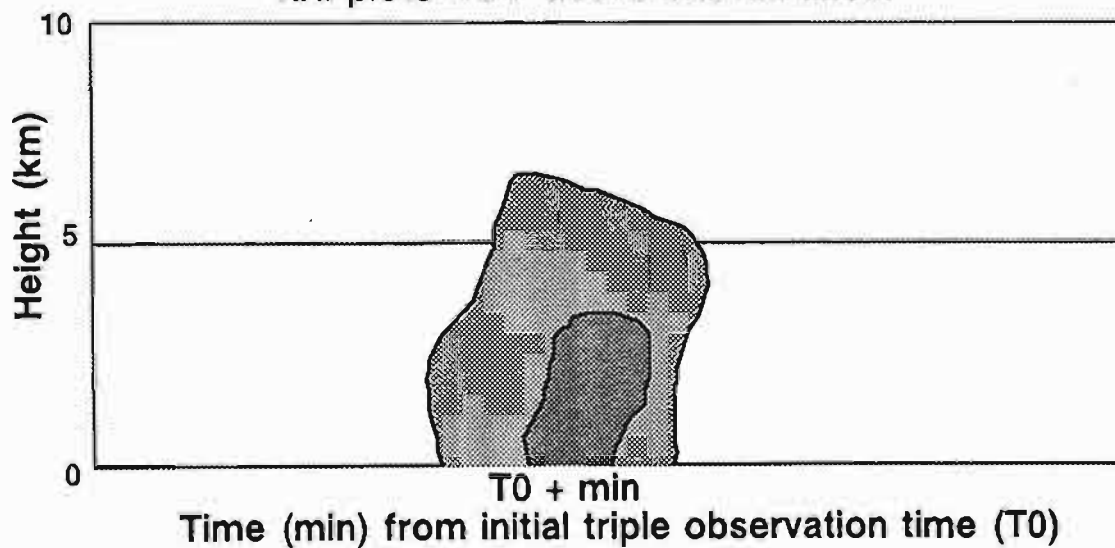



15 JUNE 91

**Description:** A large cell moved slowly from the WNW to the ESE, and divided into two separate cells after a small microburst was produced. The northernmost cell dissipated, while the southern cell produced a second weak microburst. The sounding taken at 2028 GMT showed light and variable winds below the freezing level (4.5 km), with increasingly stronger northerly winds above. The surface temperature was 29.1°C, the dew point was 18.3°C, and the lifted condensation level was 0.9 km.

The accompanying sketch shows the position of the cell at  $T_0$ , moving into the triple Doppler region. The cell produced a microburst outside of the triple region at  $T_0 + 19$  min, and divided into two separate cells at  $T_0 + 29$  min (not shown). The northernmost cell dissipated, and the other is shown at its position at  $T_0 + 49$  min, the time of maximum outflow.

**Triple Doppler Times:** 1905 – 2045 MIT/UND/TDWR  
2126 – 2150

**Total Coverage Times:** 1310 – 2300, TDWR  
1852 – 2202, UND  
1759 – 2242, MIT

**Site Observations:** MB (14 m/s) 1954 (15/013), MCO ✓†  
GF ( 8 m/s) 2049 (11/007), MCO  
MB (14 m/s) 2116 (10/043)

**Dual Doppler Times:** 1852 – 1905 UND/TDWR  
2045 – 2126 UND/TDWR  
2153 – 2202 UND/TDWR\*

\*Scanning < 9° for UND between 2159 – 2202

**RHI Scans:** MIT  
1801 – 1805, NW/N/NE  
1805 – 1806, SW  
1807 – 1819, N  
1827 – 1828, NE  
2202 – 2240, NW/NE/SE  
UND  
2152 – 2153, SE  
TDWR  
2242, 2247, 2252 – 2253, 2258, SE

**ASR-WSP data:** 1854 – 1912  
2035 – 2055  
2058 – 2141

**Sounding Times:** 1154, 1513, 1748, 2028

**Aircraft data:** Yes, MB penetrated between 1927 – 2031

**ACARS data:** Yes

**Mesonet and LLWAS data:** None

**AWOS data:** Yes

**Interferometer data:** None

**Corona point data:** None

15 JUNE 91

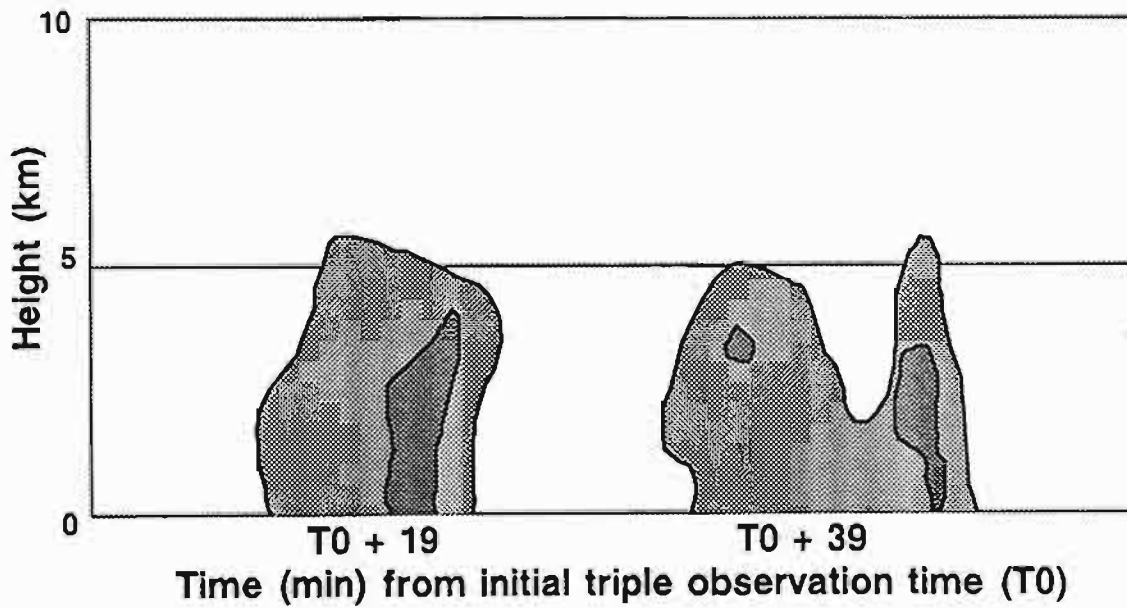
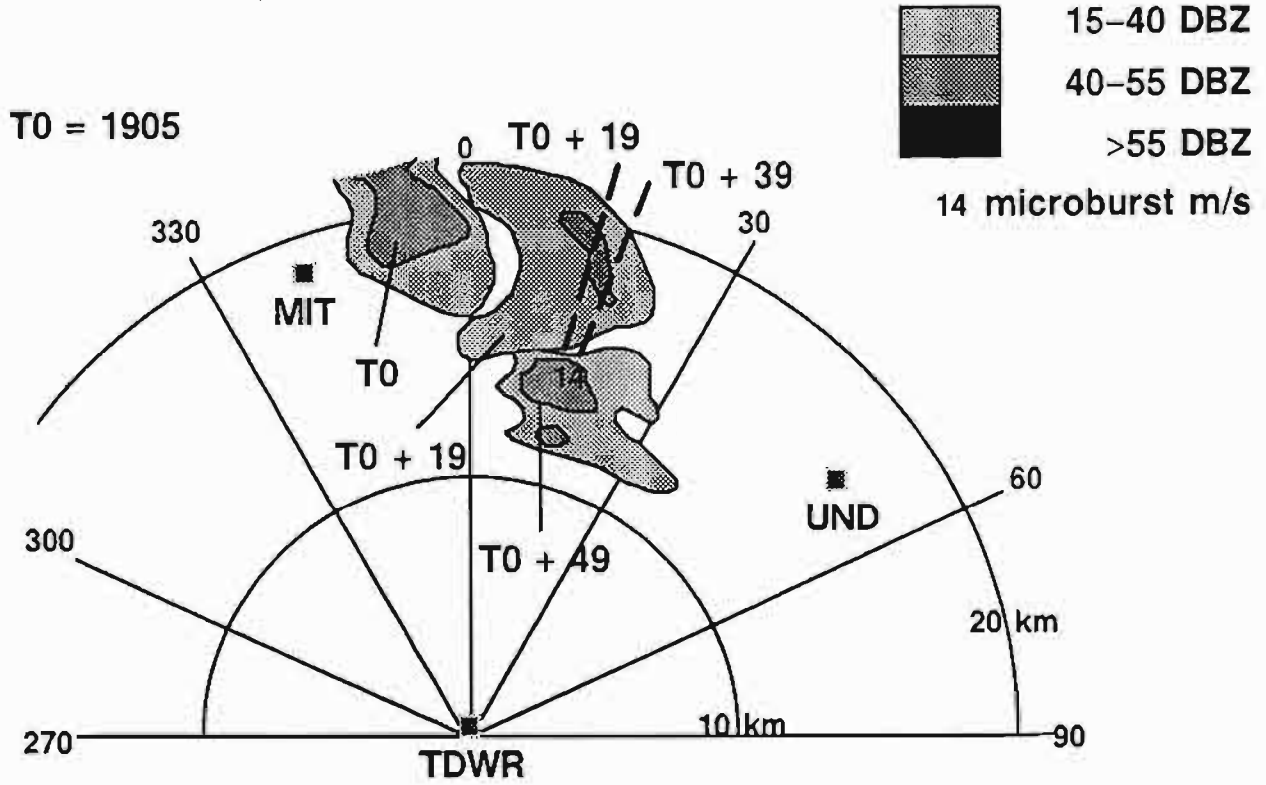

16 JUNE 91

**Description:** A weak seabreeze front moving in from the west coast triggered rapid growth in a small cell close to the TDWR testbed. This cell merged with other tiny, rapidly developing cells, forming a large complex that moved slowly to the E. This complex produced many microbursts, the strongest of which was 37 m/s. The sounding taken at 2028 GMT showed light and variable winds below the freezing level (4.9 km), and north-northwesterly winds, slowly increasing with height, above. The surface temperature was 31.3°C, the dew point was 18.1°C, and the lifted condensation level was 1.1 km.

The accompanying sketch shows the developing cell at  $T_0 + 13$  min, which forms the large, multicell complex at  $T_0 + 41$  min. This storm produced a 37 m/s outflow at  $T_0 + 41$  min. The RHI at  $T_0 + 44$  min shows a new core forming aloft at 5 km altitude.

**Triple Doppler Times:** 2217 - 2319 MIT/UND/TDWR

**\*\*Important Note --** More triple Doppler coverage may have been available if the archived tape from MIT, JUN16B, could have been inventoried. This tape was not readable and the Doppler coverage time shortened. However, no alarms were given for MCO during this void time (1901 - 2217).

**Total Coverage Times:** 1536 - 0015, TDWR  
2131 - 2357, UND  
1837 - 1901, 2217 - 2319, MIT

**Site Observations:** MB (20 m/s) 2221 (10/342), MCO  
MB (14 m/s) 2231 (04/056), MCO  
MB (28 m/s) 2241 (05/015), MCO  
MB (15 m/s) 2241 (02/020), MCO  
MB (12 m/s) 2250 (09/024), MCO  
MB (37 m/s) 2258 (07/049), MCO ✓†  
GF (7m/s) 2351 (18/344), MCO

**Dual Doppler Times:** 2145 - 2341 UND/TDWR, over airport.

**RHI Scans:** MIT  
1839 - 1840, SE  
1842 - 1843, NE  
UND  
2341 - 2345, 2349 - 2353, NE/E/SE

**ASR-WSP data:** 1610 - 1620  
2145 - 2158  
2204 - 2223  
2236 - 2317

**Sounding Times:** 1149, 1448, 1755, 2028

**Aircraft data:** 1739 - 1823. Significant weather was not encountered during this flight. Aircraft data are not available for the microburst alarm given after 2200.

**ACARS data:** Yes

**Mesonet and LLWAS data:** None

**AWOS data:** Yes

**Interferometer data:** None

**Corona point data:** None

16 JUNE 91

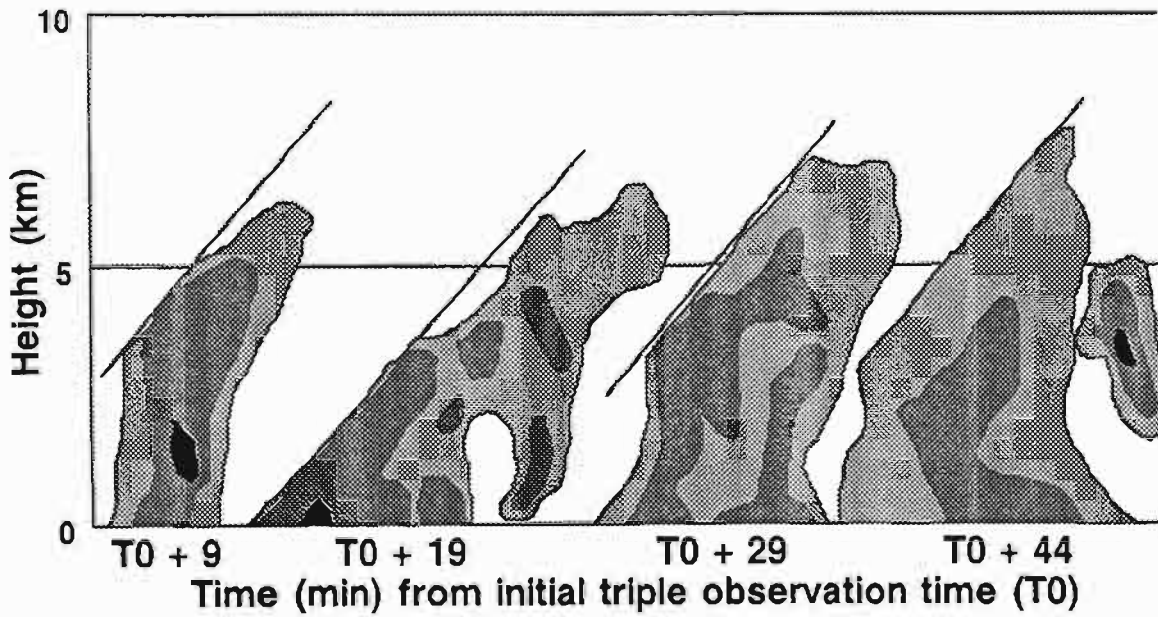
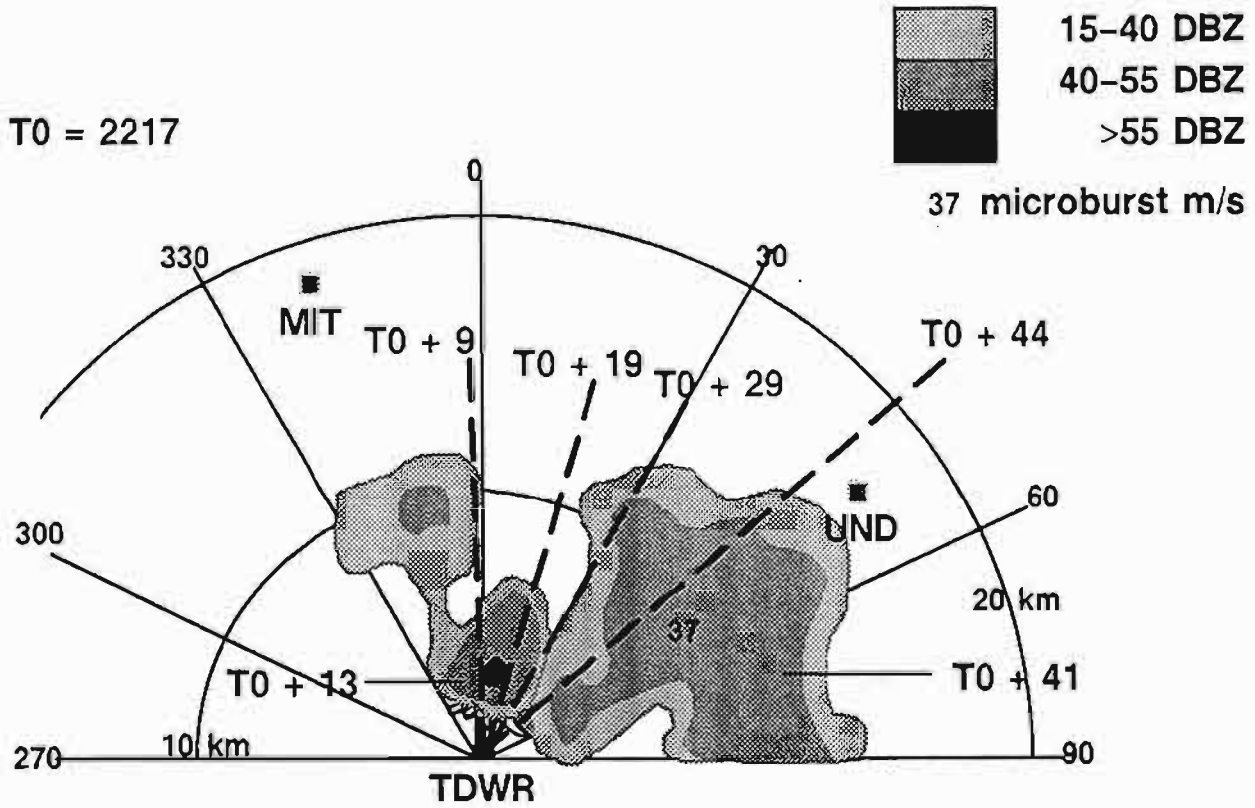

17 JUNE 91

**Description:** A NE/SW oriented gust front produced by a group of old thunderstorms passed through the triple Doppler region in advance of a small line of thunderstorms. The gust front initiated new development along the southern end of the line, which continued until a significant line of strong thunderstorms had been produced. The sounding taken at 1741 GMT showed light to moderate southwesterly winds below the freezing level (4.8 km), and light and variable westerly winds above. The surface temperature was 26.1°C, the dew point was 17.8°C, and the lifted condensation level was 0.7 km.

The accompanying sketch shows the initial group of cells as they entered the triple Doppler region at  $T_0$ , and how new development along the southern edge of the group produced a significant line of thunderstorms by  $T_0 + 46$  min.

**Triple Doppler Times:** 1749 - 1800 MIT/UND/TDWR\*  
1803 - 1819  
1828 - 1940

\*Scanning < 9° for UND between 1749 - 1800.

Important Note -- MIT was scanning between 60 and 80 degrees between 1819 and 1828, explaining the 9 minute gap of triple Doppler coverage.

**Total Coverage Times:** 1530 - 2259, TDWR  
1737 - 1940, UND  
1621 - 1953, MIT

**Site Observations:** GF (12 m/s) 1819 (05/344), MCO  
MB (16 m/s) 1831 (16/355), MCO  
MB (13 m/s) 1852 (03/038), MCO  
MB (18 m/s) 1855 (04/042), MCO  
MB (15 m/s) 1859 (08/038), MCO ✓  
MB (11 m/s) 1859 (14/025)  
MB (20 m/s) 1909 (12/032), MCO ✓  
MB (24 m/s) 1914 (10/031), MCO ✓†  
MB (17 m/s) 1915 (09/048), MCO ✓

**Dual Doppler Times:** 1737 - 1749 UND/TDWR\*  
1940 - 1953 MIT/TDWR

\*Scanning < 9° for UND between 1737 - 1749.

**RHI Scans:** MIT  
1621 - 1650, SE  
1650 - 1744, W/NW/N  
1744 - 1748, SW

**ASR-WSP data:** 1821 - 1902  
1909 - 1939

**Sounding Times:** 1156, 1448, 1741, 2026, 2128

**Aircraft data:** Yes, gust front and microbursts were penetrated between 1742 - 1938

**ACARS data:** Yes

**Mesonet and LLWAS data:** None

**AWOS data:** Yes

**Interferometer data:** None

**Corona point data:** None

**Other Notes:** Gust front highly visible approximately 8 km ahead of squall line and movement was to the SE at 24 km/hr.



17 JUNE 91

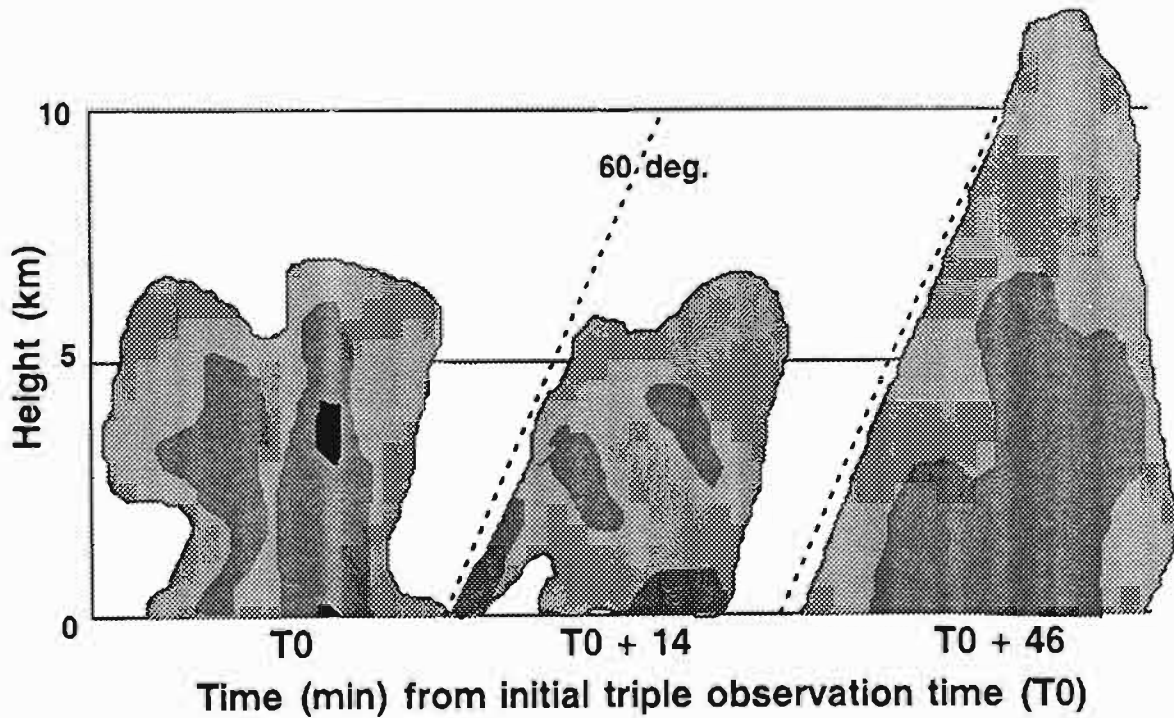
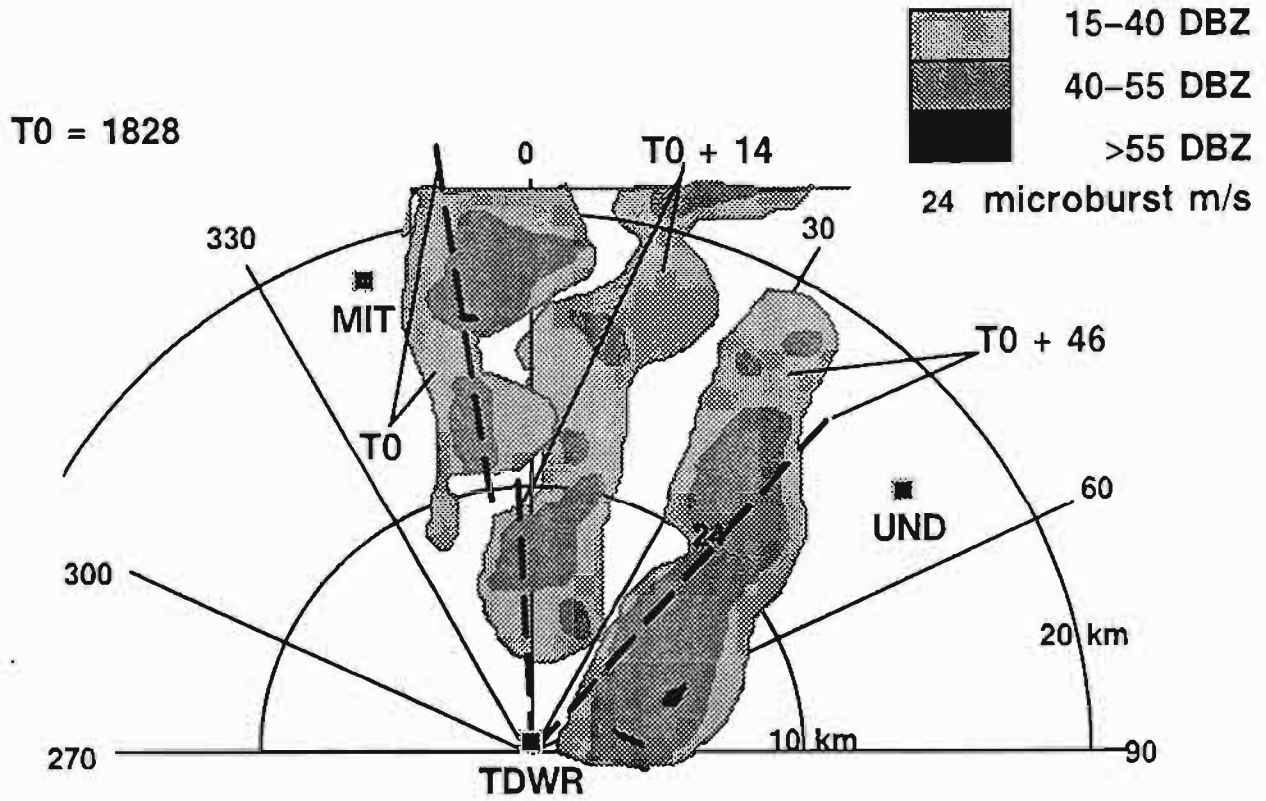

18 JUNE 91

**Description:** At the beginning of the triple Doppler period, a cell was located due north of the TDWR testbed. While it slowly moved eastward and dissipated (after producing a weak microburst) two more small cells formed to the S. These cells dissipated rapidly, without growing to any substantial height. The sounding taken at 2047 GMT showed light and variable winds from the surface to 16 km. The surface temperature was 28.2°C, the dew point was 20.8°C, the freezing level was 4.7 km, and the lifted condensation level was 0.6 km.

The accompanying sketch shows the movement of the first cell from its beginning at  $T_0$  to its dissipation at  $T_0 + 35$  min. The two later-forming cells that began at  $T_0 + 35$  min are also shown.

**Triple Doppler Times:** 2037 - 2116 MIT/UND/TDWR

**Total Coverage Times:** 1512 - 2122, TDWR  
1801 - 2116, UND  
1921 - 2140, MIT

**Site Observations:** MB (14 m/s) 2047 (11/003), MCO ✓†

**Dual Doppler Times:** 1801 - 1918 UND/TDWR, over airport  
2117 - 2122 MIT/TDWR, to NE

**RHI Scans:** MIT  
1921 - 2023, NE/SE  
2023 - 2037, SE  
2122 - 2140, SE

**ASR-WSP data:** 2043 - 2059

**Sounding Times:** 1300, 1550, 1850, 2047

**Aircraft data:** 1856 - 2118, 13 m/s mb observed at 2048 near runway

**ACARS data:** Yes

**Mesonet and LLWAS data:** None

**AWOS data:** Yes

**Interferometer data:** None

**Corona point data:** 2037 - 2116  
Stations C24, C14, C7

18 JUNE 91

T0 = 2037

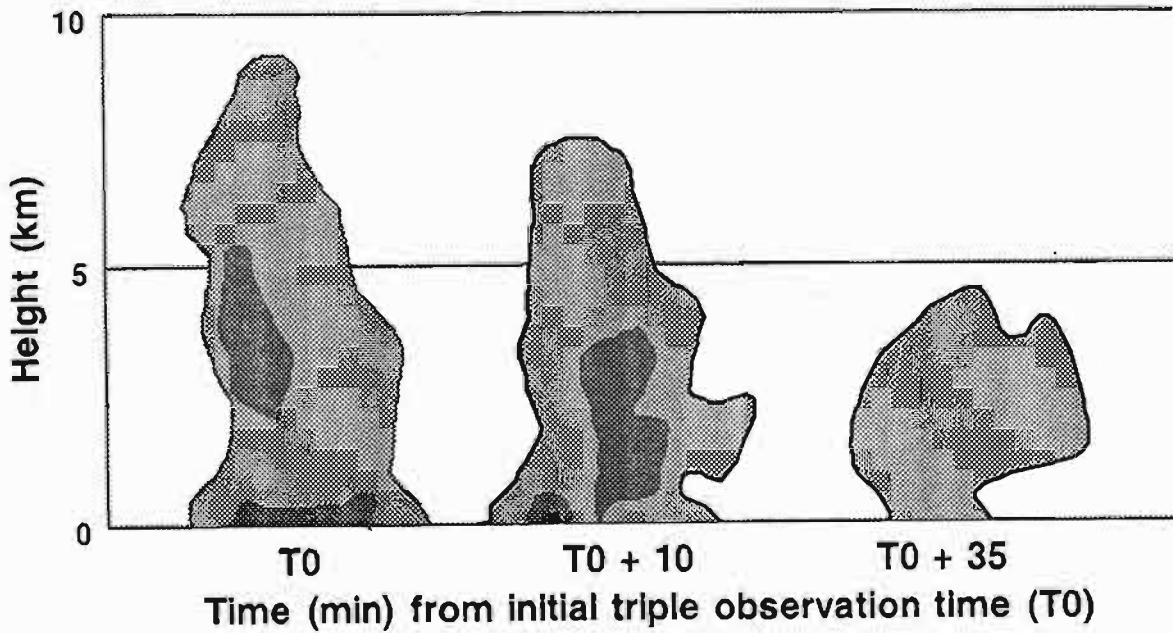
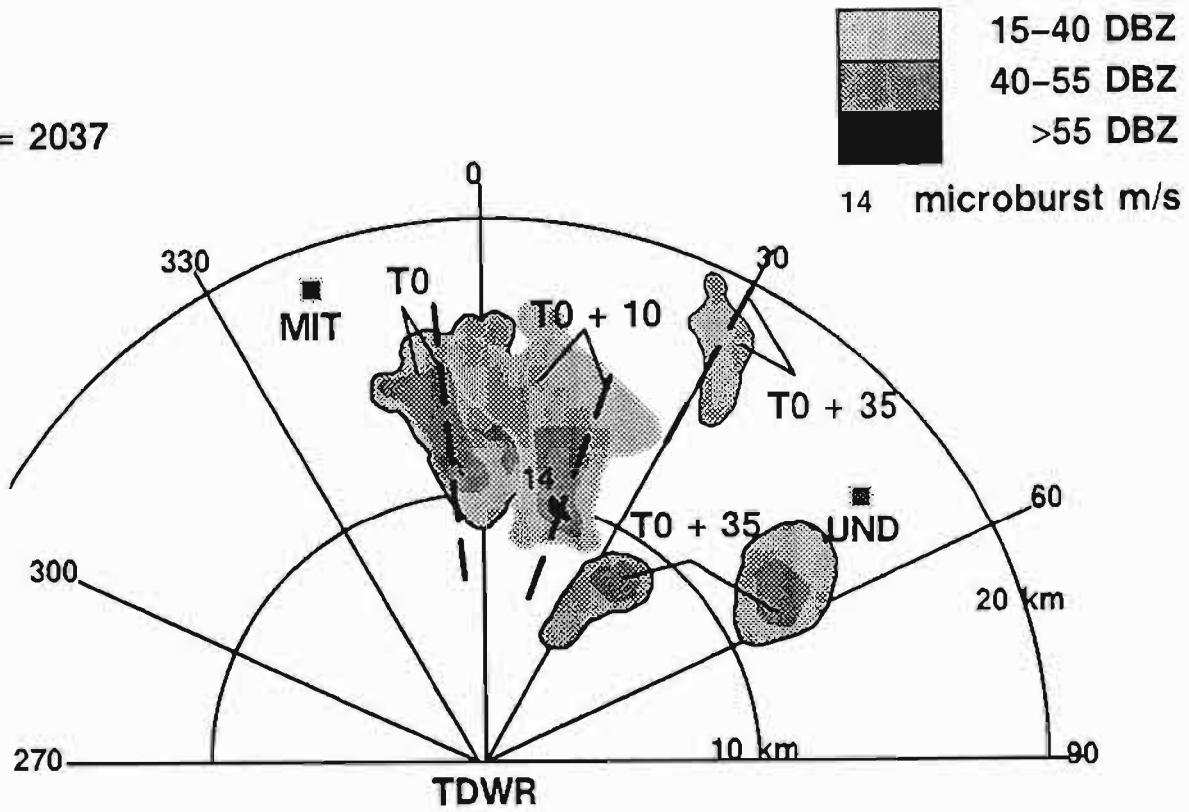

19 JUNE 91

**Description:** In the first triple Doppler period a few cells were forming in the triple region and moving to the ENE. One cell developed rapidly as it crossed the triple region, producing a 20 m/s microburst. A second cell formed just to the north, growing as the first cell dissipated. The sounding taken nearest this time, at 1748 GMT, showed light and variable winds throughout the layer. The surface temperature was 28.9°C, the dew point was 20.4°C, the freezing level was 5.0 km, and the lifted condensation level was 0.7 km. The second triple period occurred an hour after that and was short (15 min) with no microbursts. During the third triple period an hour and a half later, the eastern seabreeze moved to the W, triggering cells behind it. Most remained outside of the triple region. The sounding taken nearest to this time, at 2051 GMT, showed light westerly winds at the surface and moderate southwesterly winds to the freezing level (5.1 km), and moderate, variable winds above. The surface temperature was 17.5°C, the dew point was 17.0°C, and the lifted condensation level was 0.0 km.

The accompanying sketch shows the cell that produced the 20 m/s microburst developing in the triple region, starting at  $T_0 + 15$  min. At  $T_0 + 48$  min, the second cell is beginning to form just to the north, and by  $T_0 + 70$  min the first cell has dissipated. The first RHI shows the cell before the time of maximum outflow, and the second RHI shows the cell at the time of maximum outflow.

**Triple Doppler Times:** 1628 - 1742 MIT/UND/TDWR\*  
1843 - 1900  
2024 - 2221

\*Scanning < 7° for MIT, 1713 - 1724, < 3° for MIT, 1725 - 1742, < 3° for UND, 1713 - 1743, and < 15° for UND, 2139 - 2149.

**Total Coverage Times:** 1535 - 2259, TDWR  
1619 - 2229, UND  
1507 - 2231, MIT

**Site Observations:** MB (22 m/s) 1716 (09/007), MCO ✓†  
MB (10 m/s) 1722 (15/025), MCO  
GF (10 m/s) 2057 (14/034), MCO  
GF (9 m/s) 2112 (09/020), MCO

**Dual Doppler Times:** 1623 - 1628 UND/TDWR  
1743 - 1843 UND/TDWR\*  
1900 - 2024 UND/TDWR\*\*  
2221 - 2229 UND/TDWR

\*Scanning < 9° for UND, 1758 - 1811.  
\*\*Scanning < 9° for UND, 1918 - 1956.

**RHI Scans:** MIT  
1507 - 1624, SE/E  
1752 - 1815, SW  
1818, 1828 - 1841, SW/W/NW/N/NE  
1903 - 2019, NE/E/SE  
2223 - 2230, SW

**ASR-WSP data:** 1640 - 1725  
1903 - 1925  
2050 - 2111  
2114 - 2157

**Sounding Times:** 1148, 1446, 1748, 2051

**Aircraft data:** Yes, Divergence encountered between 1727 - 1742

**ACARS data:** Yes

**Mesonet and LLWAS data:** None

**AWOS data:** Yes

**Interferometer data:** None

**Corona point data:** 1628 - 1742  
Stations C24, C7, C3  
1843 - 1900  
Stations C7, C6  
2024 - 2221  
Stations C24, C14, C7, C3, C6, C1

**Other Notes:** MB (18 m/s) to East at 2119 is captured by the full surface scan, but not the volume collected by TDWR. Therefore, this MB is not included in any statistics done for triple Doppler coverage in 1991.

# 19 JUNE 91

T0 = 1628

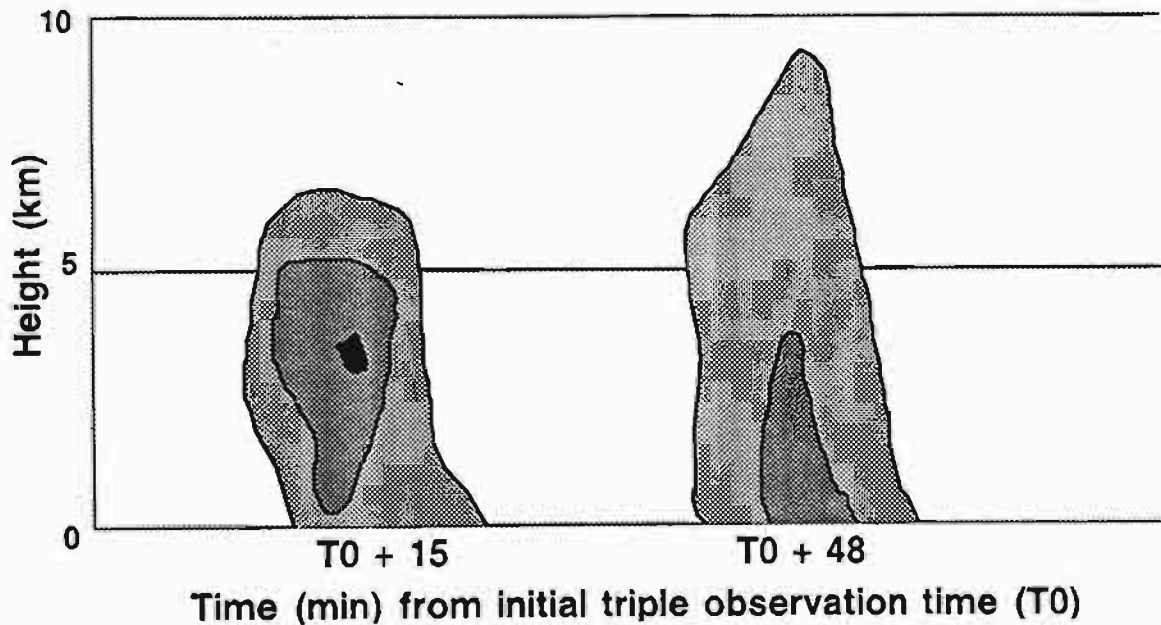
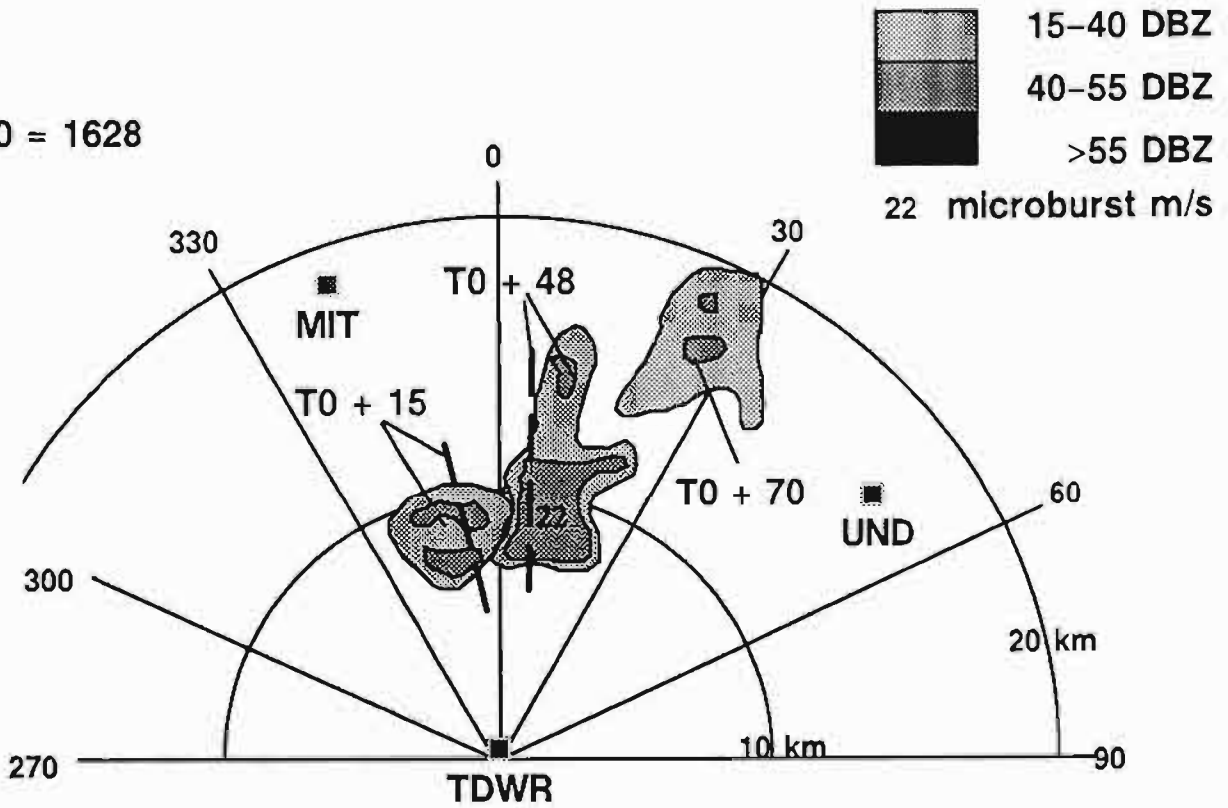

20 JUNE 91

**Description:** A gust front produced by an old thunderstorm passed through the triple Doppler area from the NW to the SE, triggering the development of a new cell. The thunderstorm moved slowly westward, but stayed within the triple Doppler region throughout its lifetime. This cell produced two microbursts, the strongest of which was 25 m/s. The sounding taken at 2035 GMT showed light and variable winds from the surface to 13 km. The surface temperature was 30.8°C, the dew point was 20.8°C, the freezing level was 4.8 km, and the lifted condensation level was 0.9 km.

The accompanying sketch shows the cell at  $T_0 + 59$  min, the time of maximum surface outflow strength. The RHIs show the cell in varying stages of development.

**Triple Doppler Times:** 2024 – 2145 MIT/UND/TDWR

**\*\*Important Note --** Various Volume Scans were taken by MIT and UND resulting in limited triple Doppler coverage at certain times. However, the low storm levels were observed by the three radars during the triple Doppler times given. Shallow volumes were collected at the following times:

2100 – 2139,	MIT
2058 – 2138,	UND

**Total Coverage Times:**

1544 – 2335,	TDWR
1820 – 2307,	UND
1658 – 2145,	MIT

**Site Observations:**

GF (8 m/s) 2105 (06/017),	MCO
MB (14 m/s) 2118 (07/017)	✓
MB (24 m/s) 2123 (08/006),	MCO ✓†

**Dual Doppler Times:** 1820 – 2307 UND/TDWR, over airport

**RHI Scans:**

MIT
1658 – 2000, NW, and full 360° with 20° azimuth increments
2003 – 2023, NE
UND
2202 – 2203, NE

**ASR-WSP data:** 2109 – 2152

**Sounding Times:** 1214, 1446, 1749, 2035



**Aircraft data:** 1905 – 2137. Direct hit through microburst at 2045, 8 nm final for runway 18. (A marginal microburst at best according to velocity field recorded by TDWR radar, also not in the favorable triple Doppler region.) Aborted landing at 2127 due to 50 knot loss reported by ATC for runway 18.

**ACARS data:** Yes

**Mesonet and LLWAS data:** None

**AWOS data:** Yes

**Interferometer data:** None

**Corona point data:** 2024 – 2145  
Stations C24, C14, C7, C3, C6, C1

20 JUNE 91

T0 = 2024

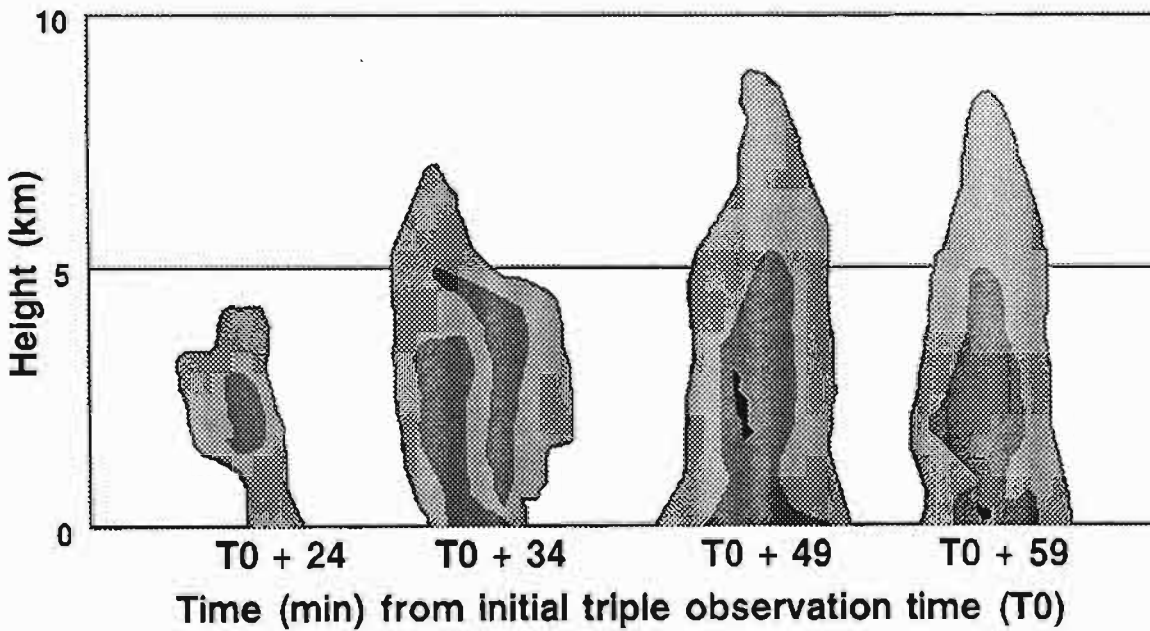
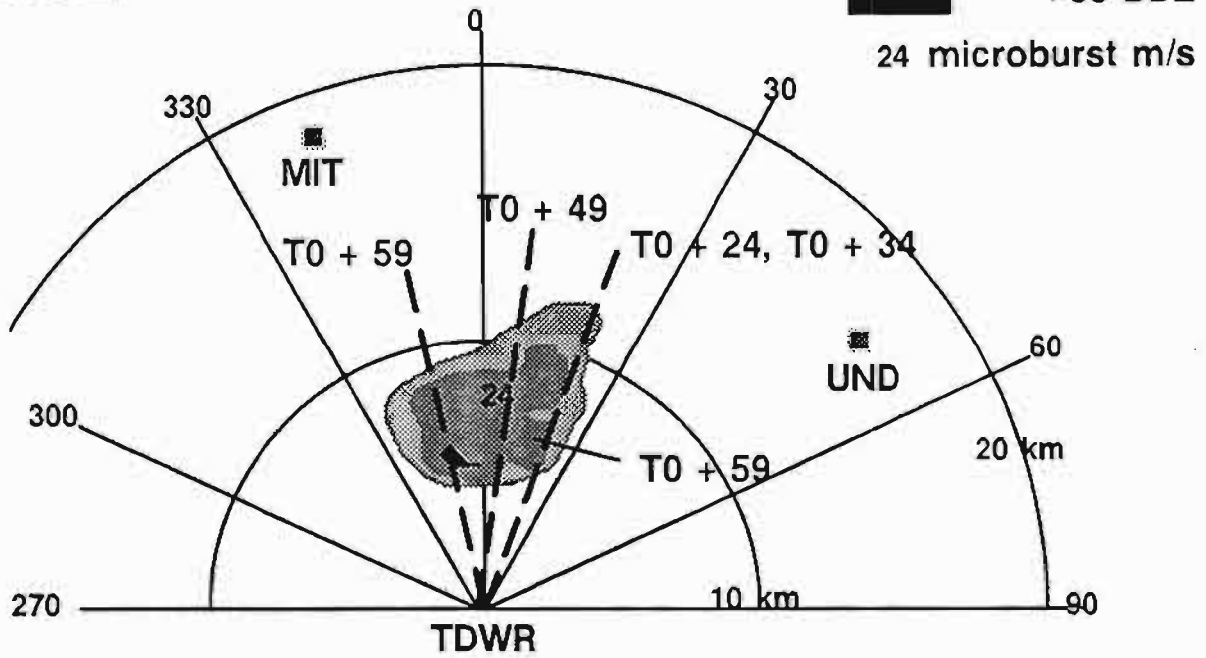
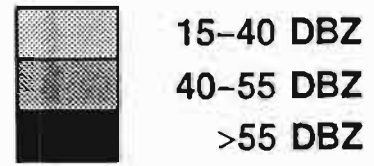

21 JUNE 91

**Description:** Many cells were present on this day, but most were outside the triple Doppler region. Two of the cells within the region, one of which had produced a weak microburst, merged to form a larger thunderstorm. The resultant cell moved to the E, quickly dissipating after producing a weak microburst. The sounding taken at 2028 GMT showed highly variable winds below the freezing level (4.9 km). They were light and variable up to 3 km, where the winds became moderate from the SSW. Above the freezing level the winds were very strong from the SW. The surface temperature was 25.3°C, the dew point was 20.5°C, and the lifted condensation level was 0.4 km.

The accompanying sketch shows the position of the two original cells at  $T_0$ . The larger of the two was responsible for a weak microburst. The sketch also shows the large thunderstorm resulting from the merge of the two cells at  $T_0 + 13$  min, the time of maximum outflow strength.

**Triple Doppler Times:** 2041 – 2113 MIT/UND/TDWR

**Total Coverage Times:** 1544 – 2113, TDWR  
1841 – 2117, UND  
2041 – 2222, MIT

**Site Observations:** GF (14 m/s) 1908 (11/001), MCO  
MB (13 m/s) 1930 (10/333), MCO  
MB (15 m/s) 2019 (15/041), MCO  
MB (21 m/s) 2030 (10/344), MCO  
MB (12 m/s) 2054 (09/017), MCO ✓†

**Dual Doppler Times:** 1841 – 2041 UND/TDWR

**RHI Scans:** None

**ASR-WSP data:** 2026 – 2109

**Sounding Times:** 1154, 1445, 1752, 2028

**Aircraft data:** None

**ACARS data:** Yes

**Mesonet and LLWAS data:** None

**AWOS data:** Yes

**Interferometer data:** None

**Corona point data:** None

21 JUNE 91

T0 = 2041

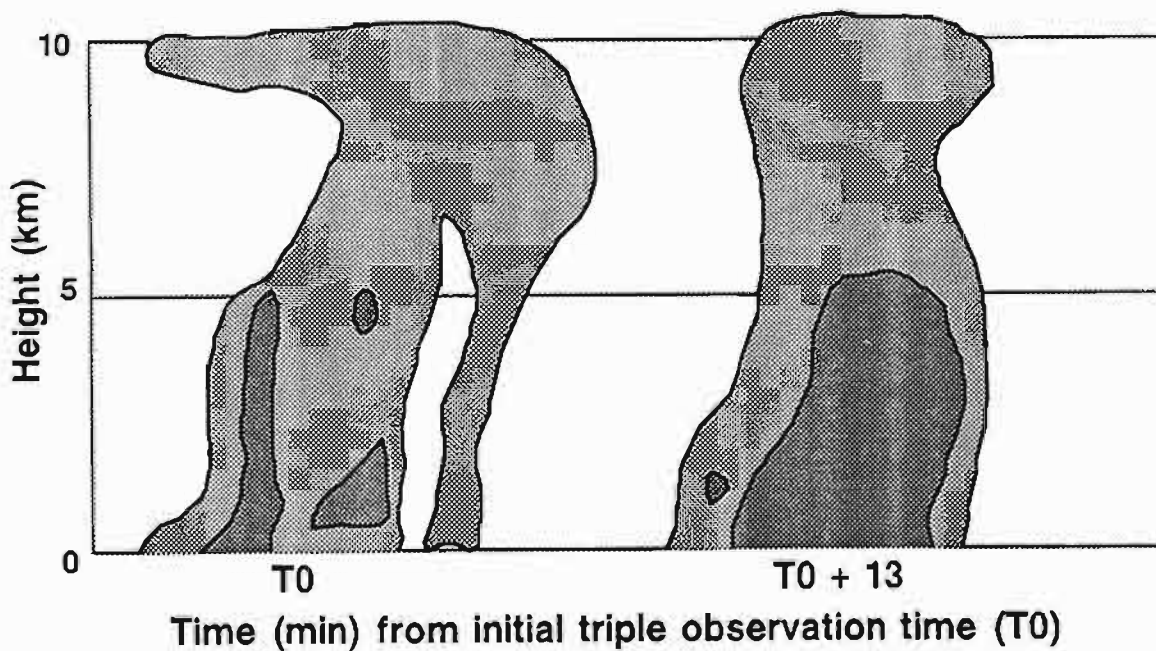
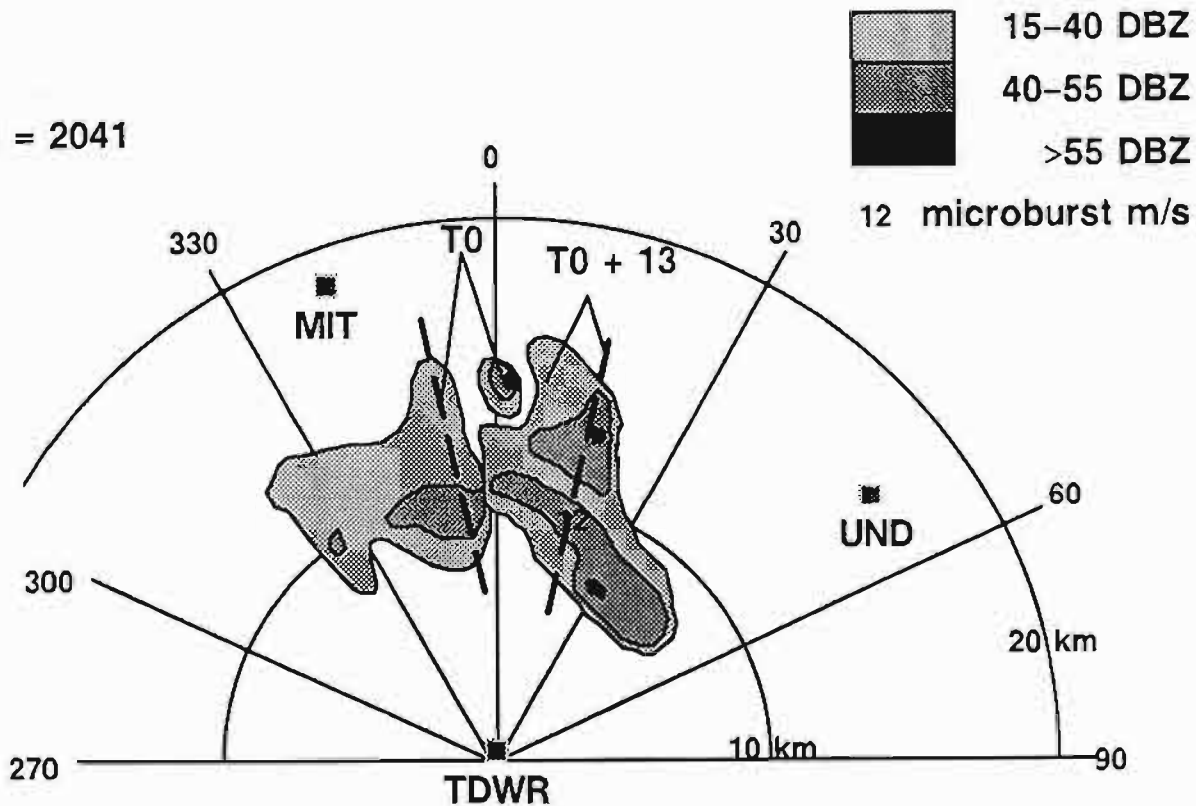

## 22 JUNE 91

**Description:** A small cell developed just to the north of the TDWR testbed, and remained essentially stationary throughout its short lifetime. The cell grew and dissipated quickly, producing a weak microburst. The sounding taken at 2045 GMT showed light southwesterly winds below the freezing level (4.8 km), and stronger winds from the SW above. The surface temperature was 31.1°C, the dew point was 19.7°C, and the lifted condensation level was 1.0 km.

The accompanying sketch shows the cell at  $T_0 + 9$ , just north of the TDWR testbed. It remained close to this position throughout its life cycle. The RHIs of this cell show that it did not grow to any substantial height.

**Triple Doppler Times:** 2200 - 2305 MIT/UND/TDWR\*

\*Scanning < 9° for UND, 2204 - 2207, and < 3° for UND, 2207 - 2209.  
Scanning < 22° for TDWR, 2200 - 2202, and < 36° for TDWR, 2203 - 2205.

**Total Coverage Times:**

1526 - 2312,	TDWR
1903 - 2305,	UND
1456 - 2322,	MIT

**Site Observations:** GF (6 m/s) 2025 (11/356), MCO  
MB (13 m/s) 2209 (05/355), MCO ✓†  
GF (7 m/s) 2212 (09/355), MCO  
GF (7 m/s) 2251 (05/033), MCO

**Dual Doppler Times:**

1939 - 2138	UND/TDWR*
2139 - 2200	MIT/UND
2305 - 2312	MIT/TDWR

\*Scanning < 9° for UND, 2114 - 2131.

**RHI Scans:** MIT

1500 - 1534,	NE/E/SE/S/SW
1534 - 1642,	E
1642 - 1748,	W/SW/S/SE
1751 - 1752,	SE
1805 - 2008,	N/NE/NW/W
2030 - 2131,	NE

**ASR-WSP data:** 2020 – 2103  
2208 – 2219

**Sounding Times:** 1153, 1449, 1750, 2045

**Aircraft data:** None

**ACARS data:** Yes

**Mesonet and LLWAS data:** None

**AWOS data:** Yes

**Interferometer data:** None

**Corona point data:** 2200 – 2305  
Stations C6, C3, C14, C24

22 JUNE 91

T0 = 2200

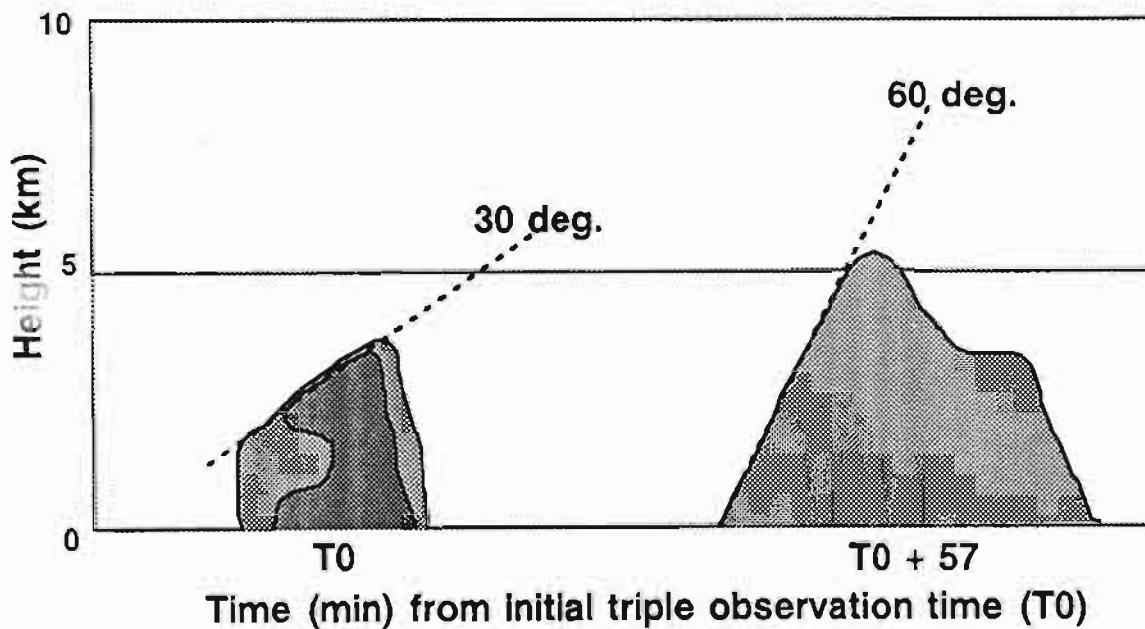
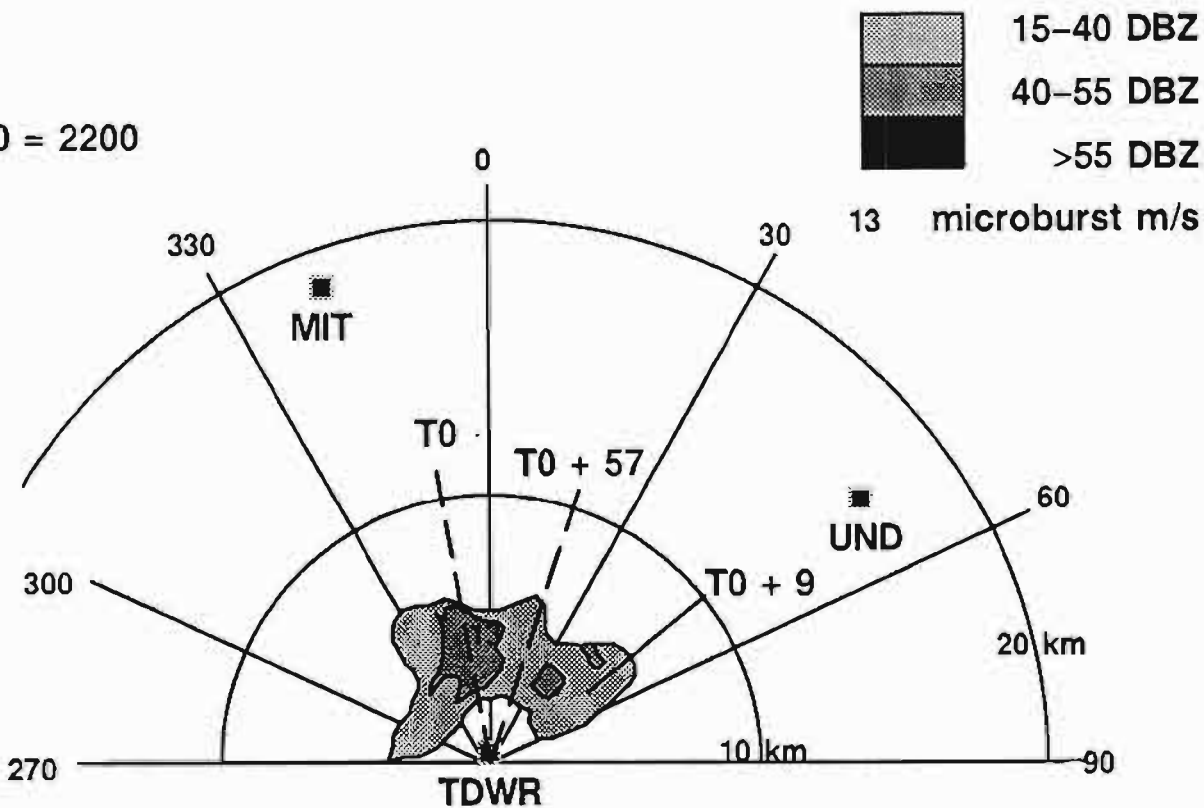



23 JUNE 91

**Description:** A strong, high reflectivity gust front originating from old thunderstorms moved from the SE to the NW across the triple Doppler region. One new cell formed behind the gust front to the SE of the center of the triple Doppler region and moved to the NW. It moved into the triple Doppler region slowly and as it did so, new cells formed nearby. These merged to form a large complex that continued to move NW. The sounding taken at 2040 GMT showed light west-northwesterly winds below the freezing level (4.8 km), and strong west-southwesterly winds above. The surface temperature was 30.7°C, the dew point was 19.8°C, and the lifted condensation level was 1.0 km.

The accompanying sketch shows the edge of the first cell at  $T_0 + 30$  min, just beginning to move into the triple Doppler region, and its position at  $T_0 + 65$  min along with a new cell to its S.

**Triple Doppler Times:** 2252 - 0032 MIT/UND/TDWR

**Total Coverage Times:** 1528 - 0045, TDWR  
2031 - 0032, UND  
1547 - 0036, MIT

**Site Observations:** MB (18 m/s) 2037 (17/020), MCO  
GF (6 m/s) 2108 (10/000), MCO  
GF (6 m/s) 2257 (07/006), MCO  
MB (17 m/s) 2357 (08/031), MCO ✓†  
MB (15 m/s) 0009 (10/015)

**Dual Doppler Times:** 0032 - 0036 MIT/TDWR, over airport  
2031 - 2252 UND/TDWR\*

\*Scanning < 9° for UND between 2116 - 2215

**RHI Scans:** MIT  
1555 - 1642, full 360 with 20 degree increments  
1642 - 1712, W/NW  
1712 - 1718, NE  
1718 - 1726, NE/W  
1728 - 2026, SW/W/NW  
2106 - 2249 E,SE

**ASR-WSP data:** 2029 - 2055  
2210 - 2226  
2231 - 2314  
2318 - 0001  
0003 - 0032

**Sounding Times:** 1155, 1449, 1747, 2040

**Aircraft data:** None

**ACARS data:** Yes

**Mesonet and LLWAS data:** None

**AWOS data:** Yes

**Interferometer data:** None

**Corona point data:** 2252 - 0032  
Stations C6, C3, C14, C24

23 JUNE 91

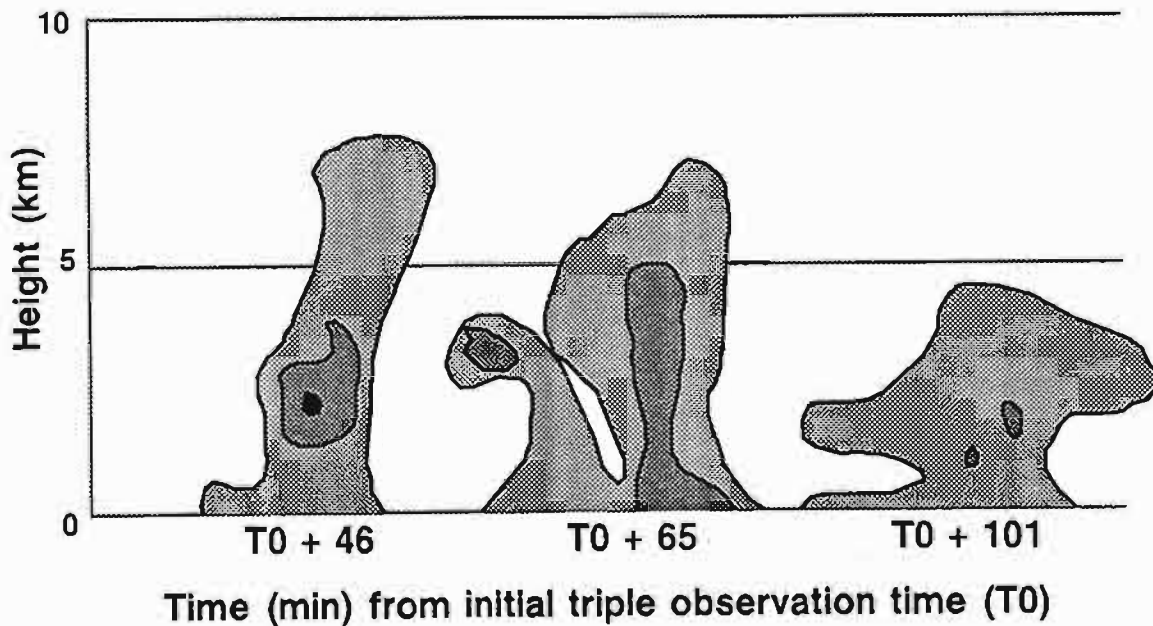
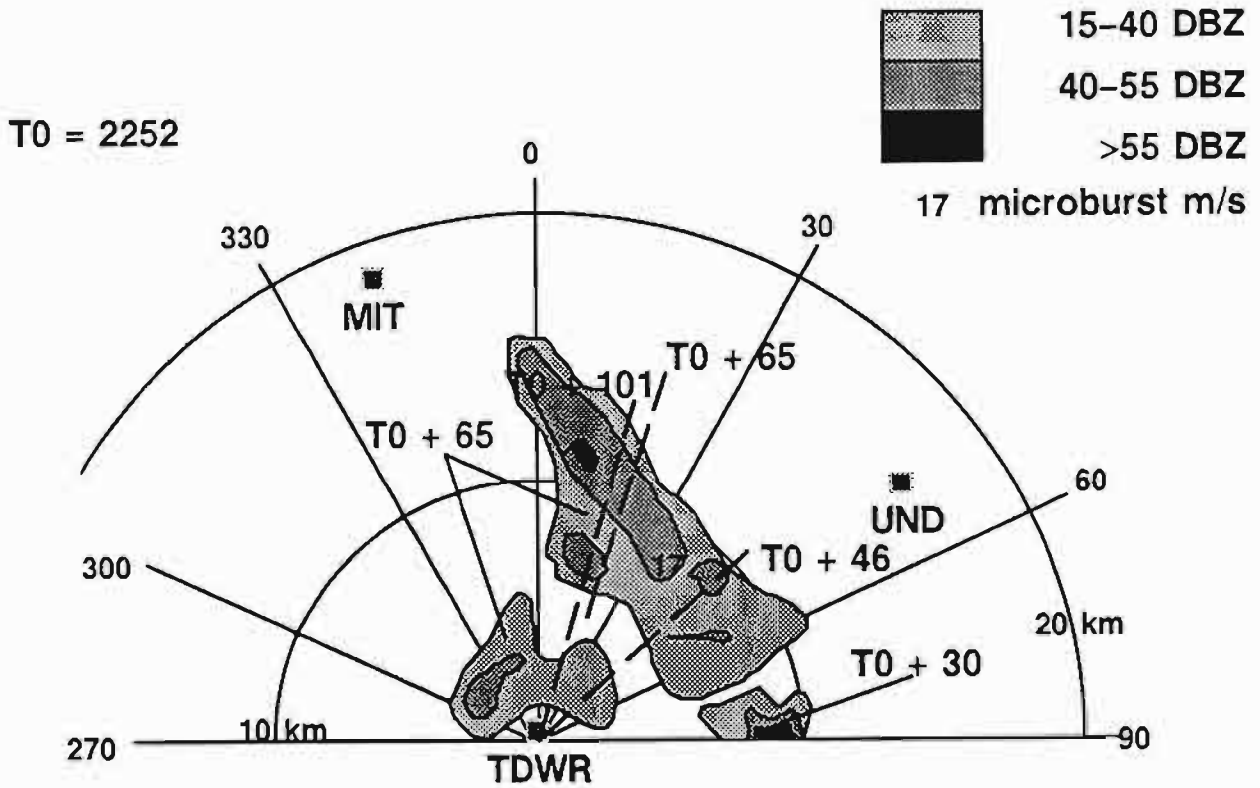

24 JUNE 91

**Description:** A gust front from an old thunderstorm passed through the triple Doppler region triggering the development of two small cells. These showers dissipated quickly and neither produced a microburst-strength outflow. There were no microbursts observed during the triple coverage on this day. The sounding taken at 2042 GMT showed moderate easterly flow at the surface, light northerly winds to 7 km, and moderate southwesterly winds above. The surface temperature was 26.1°C, the dew point was 21.3°C, the freezing level was 4.7 km, and the lifted condensation level was 0.4 km.

The accompanying sketch shows the passage of the gust front through the triple Doppler region, and the two showers triggered by its passage. The RHI shows the maximum vertical extent of the two showers.

**Triple Doppler Times:** 1922 - 1934 MIT/UND/TDWR

**Total Coverage Times:** 1529 - 2259, TDWR  
1900 - 2100, UND  
1634 - 2253, MIT

**Site Observations:** GF (8 m/s) 1909 (15/025), MCO †  
(shown in sketch at 1928)

**Dual Doppler Times:** 1934 - 2100 UND/TDWR

**RHI Scans:** MIT  
1639 - 1708, W/NW  
1708 - 1820, NE/E  
1820 - 1904, NW  
1904 - 1920, NE/E  
2126 - 2238, W  
2238 - 2249, NE  
UND  
1914 - 1916, 1919 - 1920, NE

**ASR-WSP data:** 1849 - 1903  
1916 - 2000  
2002 - 2044

**Sounding Times:** 1155, 1445, 1754, 2042

**Aircraft data:** None

**ACARS data:** Yes

**Mesonet and LLWAS data:** None

**AWOS data:** Yes

**Interferometer data:** None

**Corona point data:** 1934 – 2100  
Stations C6, C3, C14, C24

24 JUNE 91

T0 = 1922

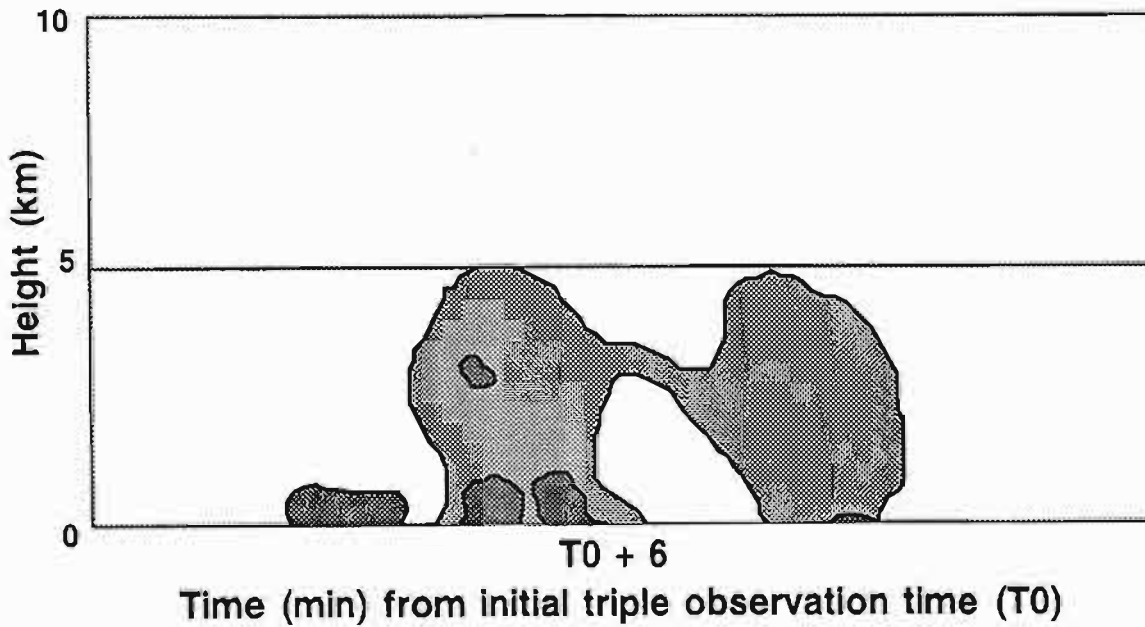
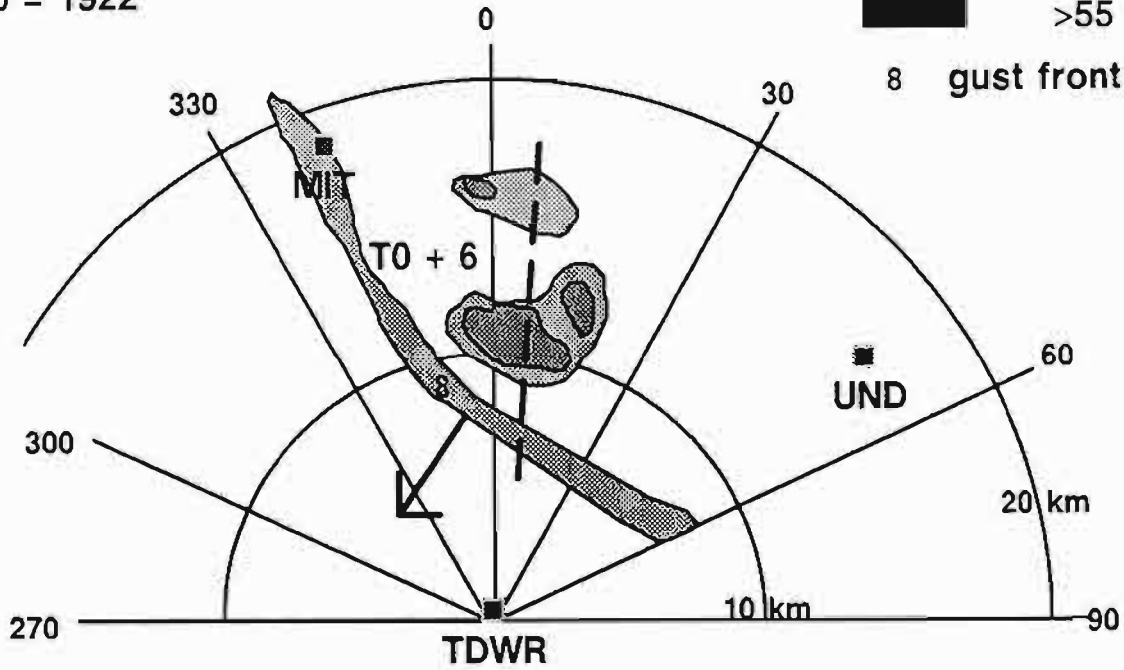
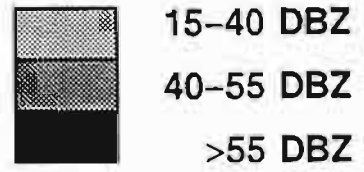

25 JUNE 91

**Description:** A gust front passed from N to S across the triple Doppler region, followed by a disorganized line of thunderstorms. New cells formed ahead of the line, and merged with it, producing a large complex that moved southward over the TDWR testbed. The sounding taken at 1744 GMT showed light and variable winds from the surface to 1 km, and moderate, variable winds to 16 km. The surface temperature was 30.7°C, the dew point was 19.5°C, the freezing level was 4.9 km, and the lifted condensation level was 1.0 km.

The accompanying sketch shows the line of thunderstorms merged with the new cells moving southward over the triple Doppler region, and dissipating as it exits the region. The RHI set shows the presence of multiple cores in the complex.

**Triple Doppler Times:** 1743 - 2037 MIT/UND/TDWR

**Total Coverage Times:** 1527 - 2238, TDWR  
1743 - 2037, UND  
1502 - 2136, MIT

**Site Observations:** GF (10 m/s) 1838 (11/009), MCO  
MB (10 m/s) 1921 (11/353), MCO  
MB (14 m/s) 1923 (05/326), MCO  
MB (21 m/s) 1935 (04/342), MCO ✓†

**Dual Doppler Times:** 1724 - 1730, MIT/TDWR  
1735 - 1740, MIT/TDWR  
2037 - 2136 MIT/TDWR, over airport

**RHI Scans:** MIT  
1507 - 1722, NE, full 360 with 20 degree increments  
1734, NE  
1740 - 1742, E

**ASR-WSP data:** 1832 - 1916  
1919 - 2002

**Sounding Times:** 1159, 1447, 1744, 2045

**Aircraft data:** None

**ACARS data:** Yes

**Mesonet and LLWAS data:** None

**AWOS data:** Yes

**Interferometer data:** None

**Corona point data:** 1743 – 2037  
Stations C6, C3, C7



25 JUNE 91

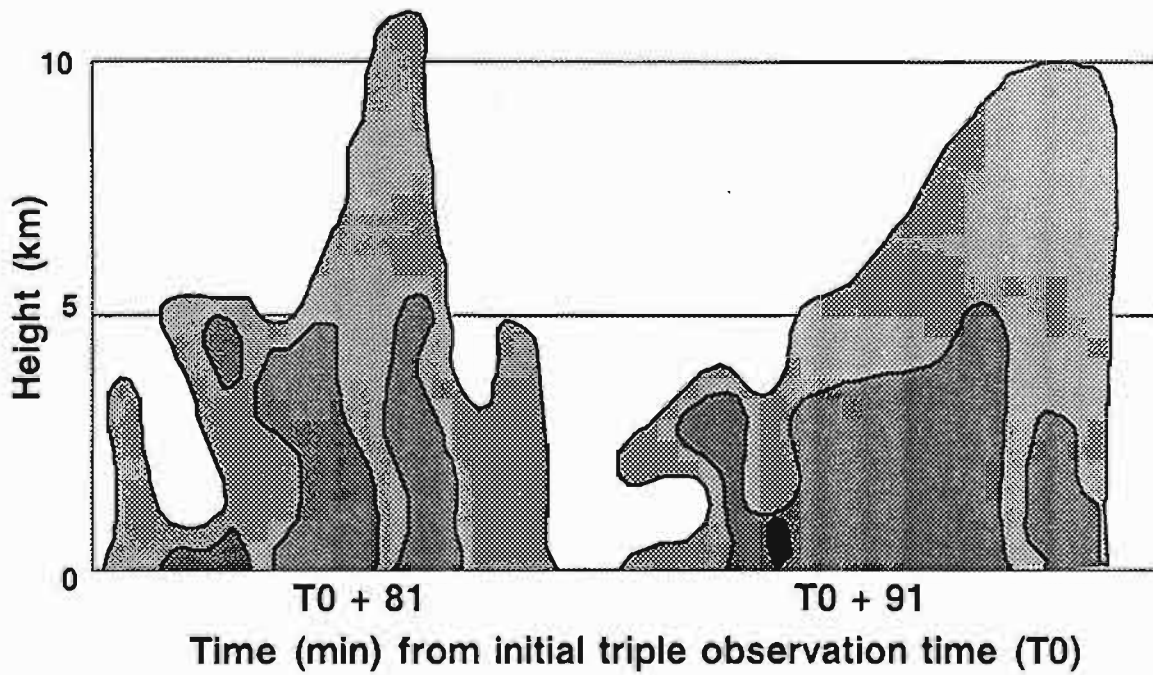
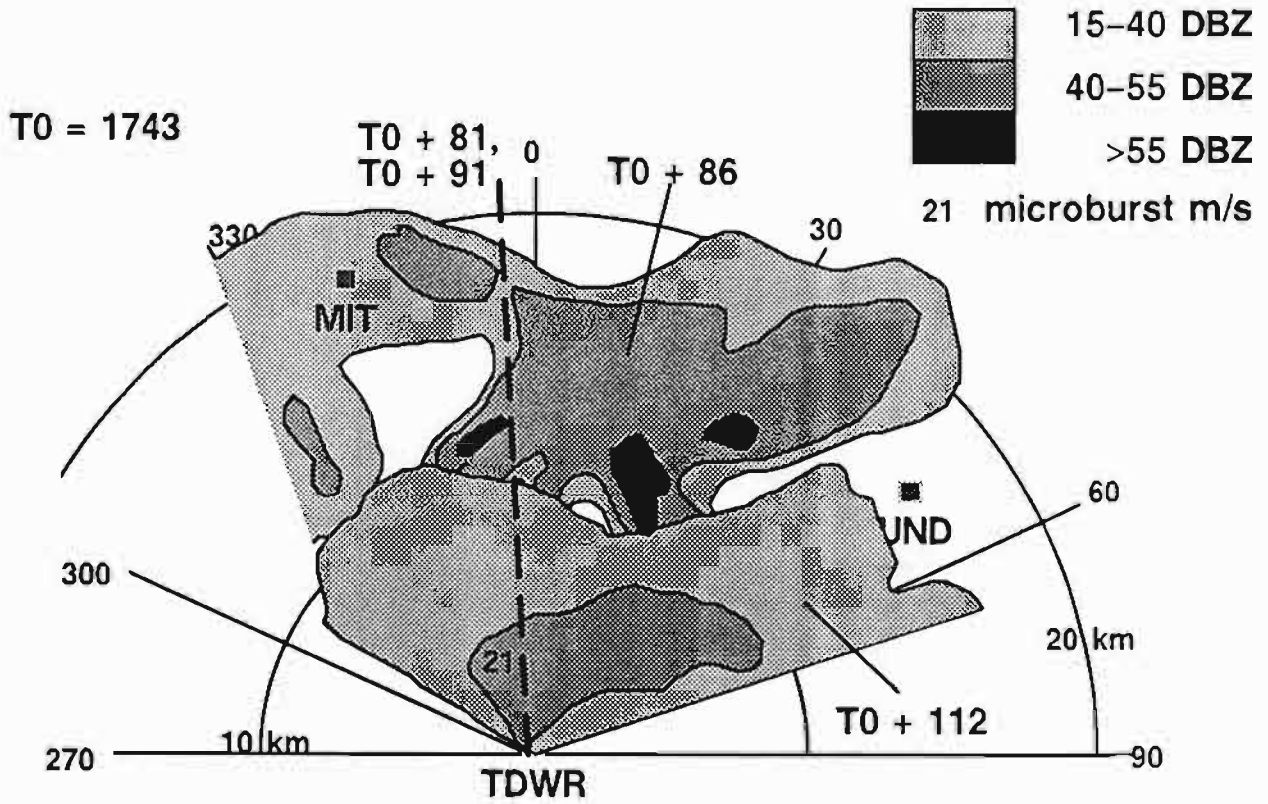

23 JULY 91

**Description:** A weak seabreeze front from the west coast passed through the triple Doppler region, triggering development of a single small shower on the edge to the region. No other development took place. The sounding taken at 1956 GMT showed light and variable winds below the freezing level (4.9 km), and increasingly stronger winds from the E above. The surface temperature was 32.0°C, the dew point was 20.8°C, and the lifted condensation level was 1.0 km.

The accompanying sketch shows the passage of the gust front through the triple Doppler region and the shower that developed in its wake. The RHI shows the maximum vertical extent of the shower.

**Triple Doppler Times:** 2127 – 2304 MIT/UND/TDWR

**Site Observations:** GF (6 m/s) 2117 (15/004), MCO †  
(shown in the sketch at 2132)

**Total Coverage Times:** 1958 – 2334, TDWR  
2000 – 2333, UND  
2014 – 2326, MIT

**Dual Doppler Times:** 2000 – 2127, MIT/TDWR  
2304 – 2326 MIT/TDWR

**RHI Scans:** MIT  
2017 – 2100 SW  
UND  
2317 – 2318, NW/N/S  
2323 – 2324, SE  
2328 – 2329, N

**ASR-WSP data:** 2040 – 2047  
2107 – 2145

**Sounding Times:** 1130, 1356, 1703, 1956

**Aircraft data:** None

**ACARS data:** Yes

**Mesonet and LLWAS data:** None

**AWOS data:** Yes

**Interferometer data:** None

**Corona point data:** 2127 – 2304  
Stations C35, C39, C24

23 JULY 91

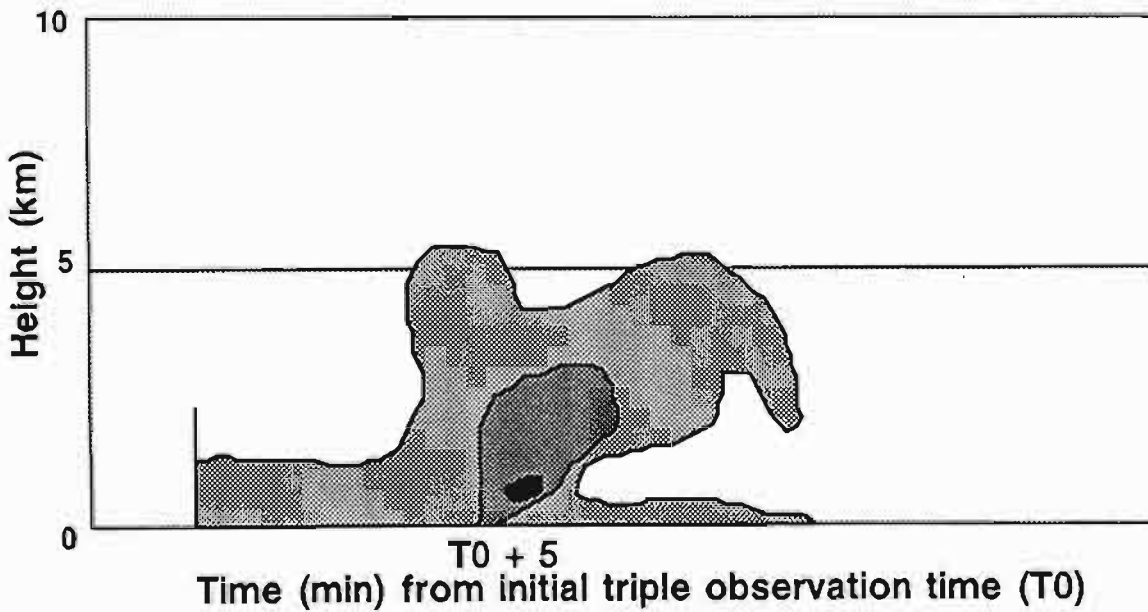
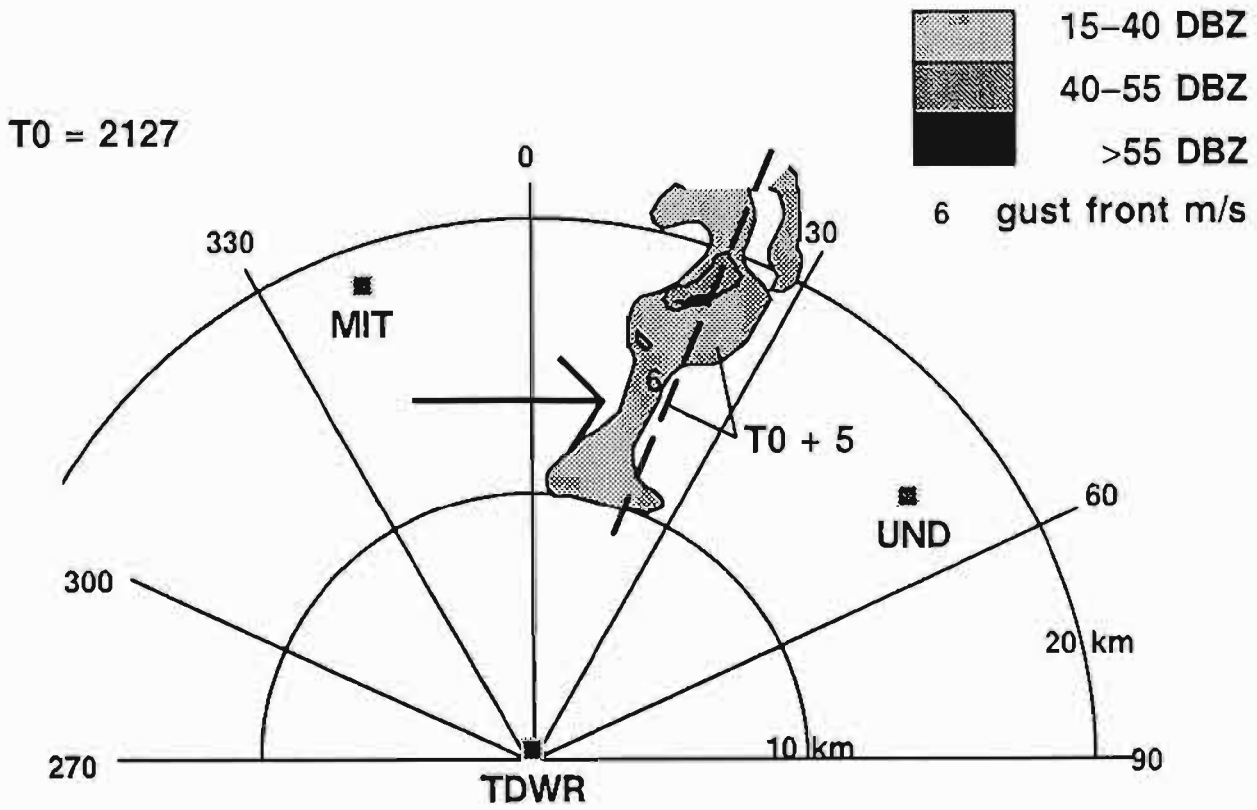

28 JULY 91

**Description:** In the early part of the triple time period, a small airmass thunderstorm quickly grew and dissipated, producing a microburst of 14 m/s. Later in the triple time period, a group of closely spaced thunderstorms moved in from the S and merged, forming a large, disorganized region of precipitation. One weak microburst was produced by this complex as it dissipated. The sounding taken at 1946 GMT showed light south-southwesterly winds below the freezing level (4.9 km), and light and variable east-northeasterly winds above. The surface temperature was 30.3°C, the dew point was 20.2°C, and the lifted condensation level was 0.9 km.

The first accompanying sketch shows the earliest cell at  $T_0 - 1$  min, the time of the maximum surface outflow. The second accompanying sketch shows the mass of thunderstorms after merging at  $T_0 + 103$ , and the resulting 12 m/s outflow.

**Triple Doppler Times:** 2234 - 0026 MIT/UND/TDWR

**Total Coverage Times:** 1929 - 0129, TDWR  
2023 - 0102, UND  
1944 - 0026, MIT

**Site Observations:** GF (12 m/s) 2222 (11/356), MCO  
MB (14 m/s) 2233 (16/041), MCO ✓†  
MB (10 m/s) 0008 (06/356), MCO  
MB (12 m/s) 0017 (10/349), MCO ✓†  
MB (12 m/s) 0023 (13/353), MCO  
MB (11 m/s) 0124 (15/032)

**Dual Doppler Times:** 2214 - 2234 UND/TDWR  
0026 - 0051 UND/TDWR

**RHI Scans:** MIT  
1946 - 2018, SE  
2018 - 2216, SW/W/NW  
UND  
2029 - 2030, SE  
2033 - 2035, 2039 - 2042, E  
2045 - 2047, SE  
0051, 0053 - 0054, NW  
TDWR  
2000 - 2359, intermittent between volume scans

**ASR-WSP data:** 2155 – 2214  
2224 – 2239  
2256 – 2307  
2326 – 2330  
2339 – 0020  
0022 – 0039

**Sounding Times:** 1119, 1344, 1645, 1946

**Aircraft data:** None

**ACARS data:** Yes

**Mesonet and LLWAS data:** 2234 – 0026

Station	1	92%	16	78%
	2	92%	17	76%
	3	70%	18	78%
	4	91%	19	78%
	5	0%	20	76%
	6	0%	21	78%
	7	0%	22	78%
	8	0%	23	78%
	9	0%	24	0%
	10	0%	25	74%
	11	0%	26	74%
	12	0%	27	74%
	13	93%	28	74%
	14	0%	29	74%
	15	0%	30	74%

**AWOS data:** Yes

**Interferometer data:** None

**Corona point data:** None

28 JULY 91

T0 = 2234

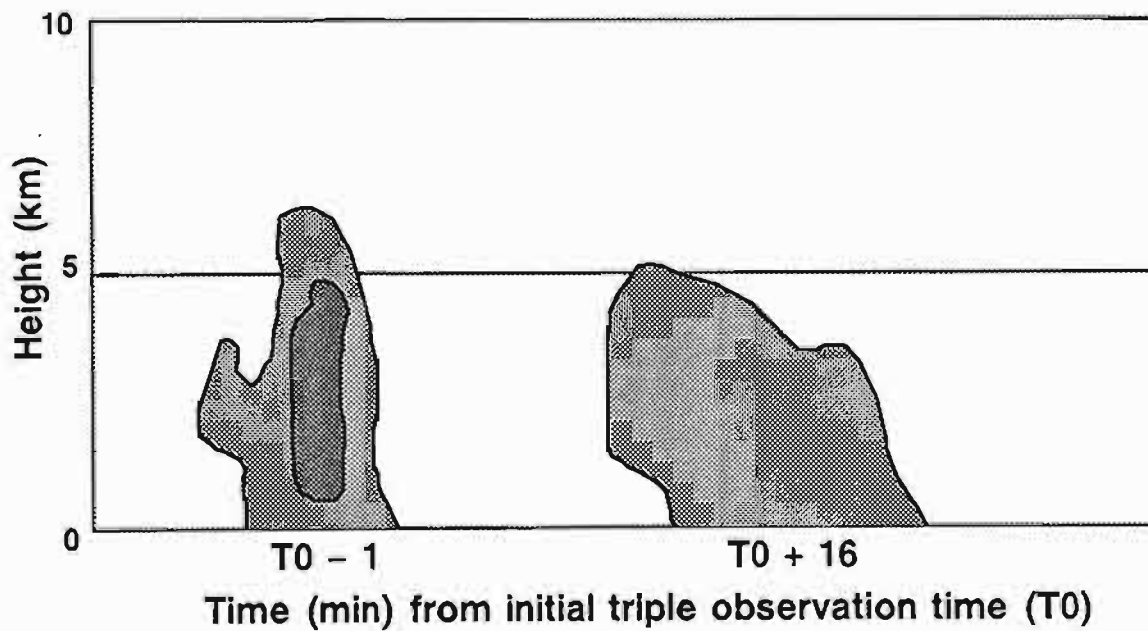
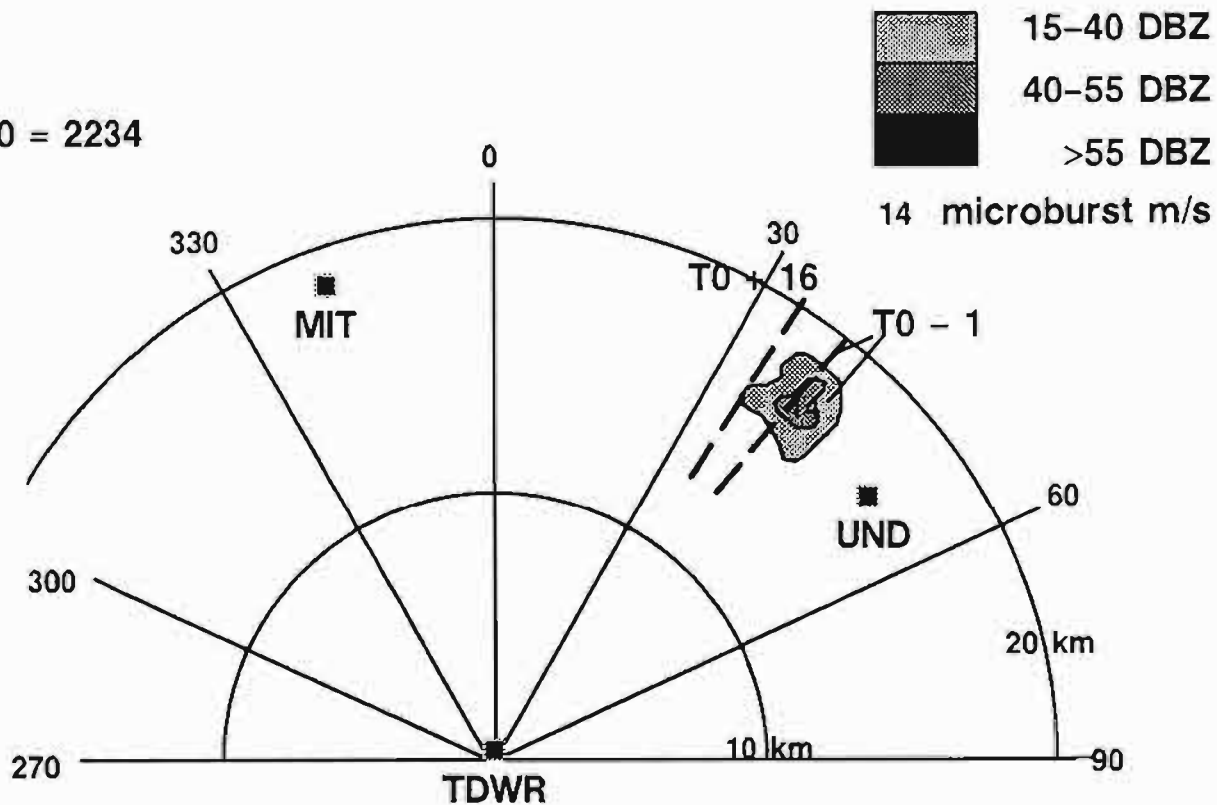

28 JULY 91

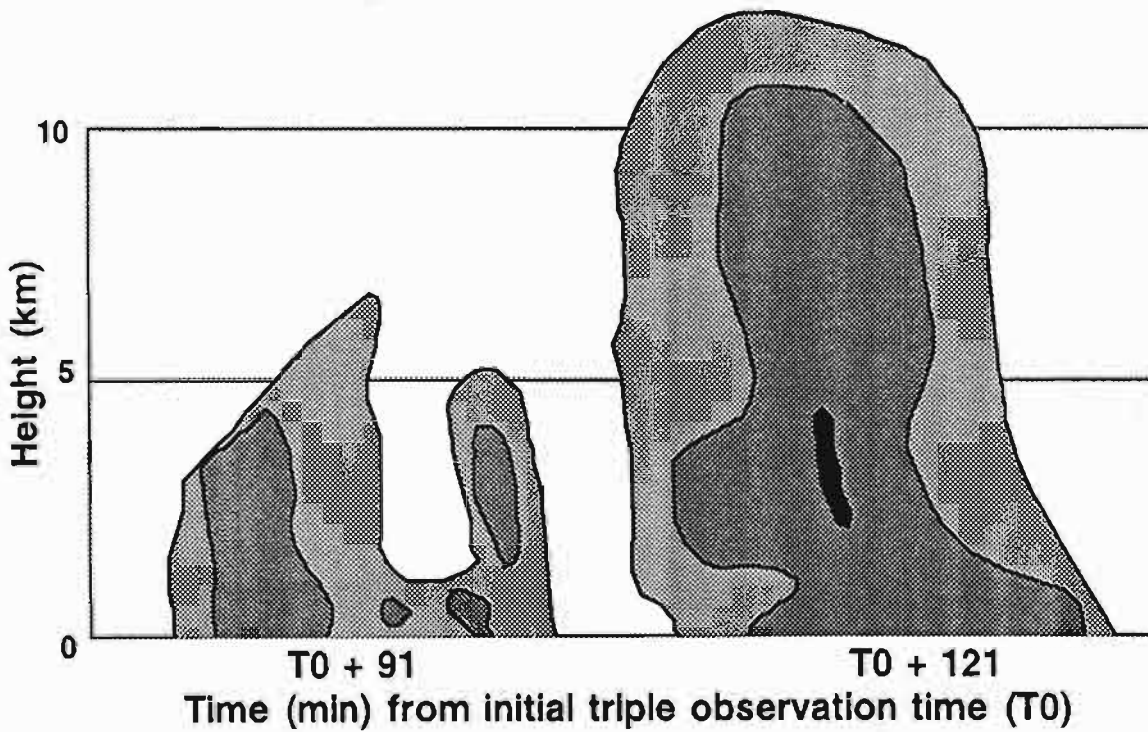
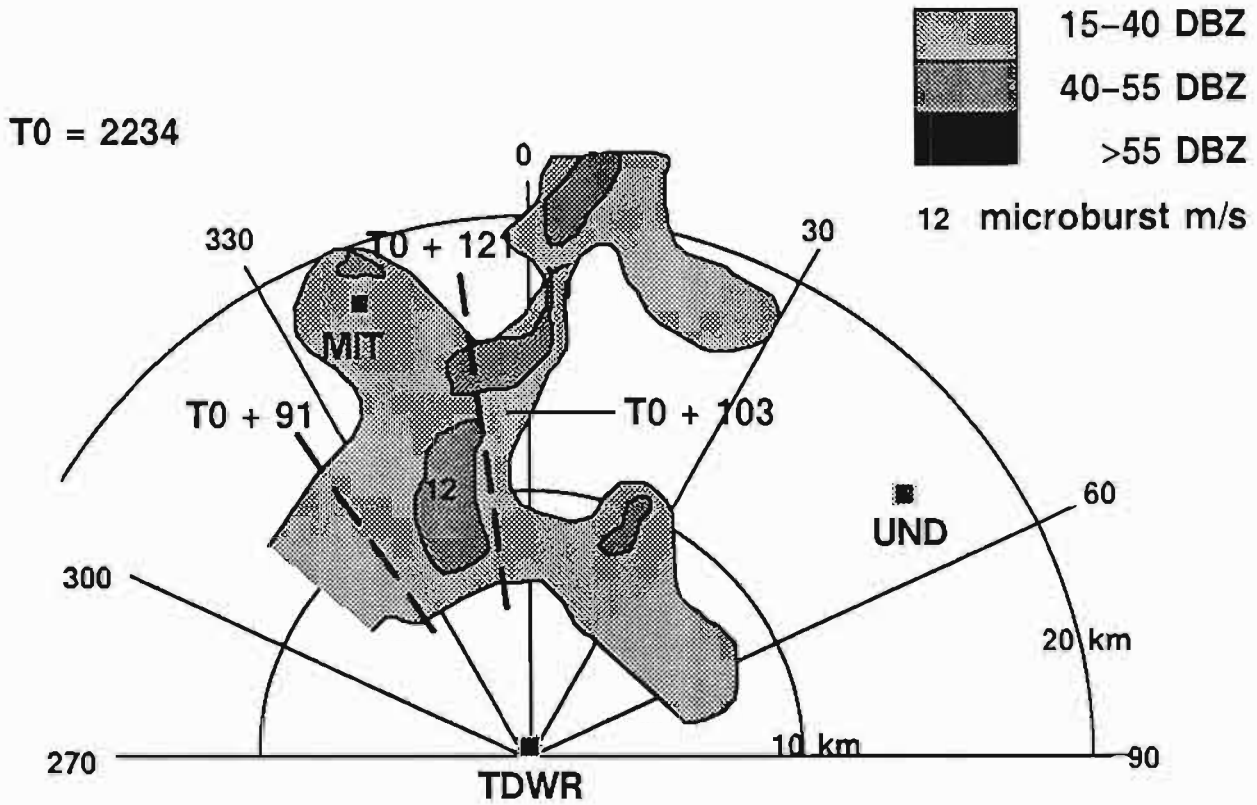



29 JULY 91

**Description:** Two large regions of showers and thunderstorms moved from the SW to the NE through the triple Doppler region. One region produced a weak microburst, while the other produced a 30 m/s microburst. One new cell formed in the region during the triple time period, but it did not produce a microburst-strength outflow. The sounding taken at 2002 GMT showed moderate southerly winds below the freezing level (4.9 km), and light and variable winds above. (Note : The sounding taken went only to 7.5 km.) The surface temperature was 31.6°C, the dew point was 19.9°C, and the lifted condensation level was 1.0 km.

The accompanying sketch shows the two regions of precipitation, one S of the MIT radar and the other to the SW of the UND radar, moving into the triple Doppler region at  $T_0 + 5$  min. The sketch also shows the developing cell to the NE of the TDWR testbed. The area of precipitation 20 km to the NE of the TDWR testbed remained outside of the triple Doppler region.

**Triple Doppler Times:** 2349 – 0047 MIT/UND/TDWR

**Total Coverage Times:** 1803 – 0049, TDWR  
2101 – 0047, UND  
1632 – 0111, MIT

**Site Observations:** GF (6 m/s) 2339 (06/044), MCO  
MB (33 m/s) 2347 (10/313), MCO ✓† (shown in the sketch at 2354)

**Dual Doppler Times:** 2325 – 2349 UND/TDWR

**RHI Scans:** MIT  
1632 – 1731, NE/N  
1732 – 1907, NW/N  
1908 – 2001, W/NW/N/NE  
202 – 2029, SE/S/SW  
UND  
2104 – 2131, NE, intermittent between volume scans  
2259 – 2317, SW, intermittent between volume scans  
TDWR  
2121 – 2134, intermittent between volume scans

**ASR-WSP data:** 2056 – 2108  
2328 – 2344  
2353 – 0031

**Sounding Times:** 1350, 1654, 2002

**Aircraft data:** None

**ACARS data:** Yes

**Mesonet and LLWAS data:** 2349 – 0047

Station	1	91%	16	83%
	2	92%	17	90%
	3	0%	18	38%
	4	93%	19	95%
	5	0%	20	79%
	6	0%	21	95%
	7	0%	22	95%
	8	0%	23	95%
	9	0%	24	0%
	10	77%	25	95%
	11	0%	26	95%
	12	0%	27	95%
	13	94%	28	95%
	14	0%	29	95%
	15	0%	30	95%

**AWOS data:** Yes

**Interferometer data:** None

**Corona point data:** 2349 – 0047

Stations C33, C32, C25, C14, C3, C22, C6, C1

29 JULY 91

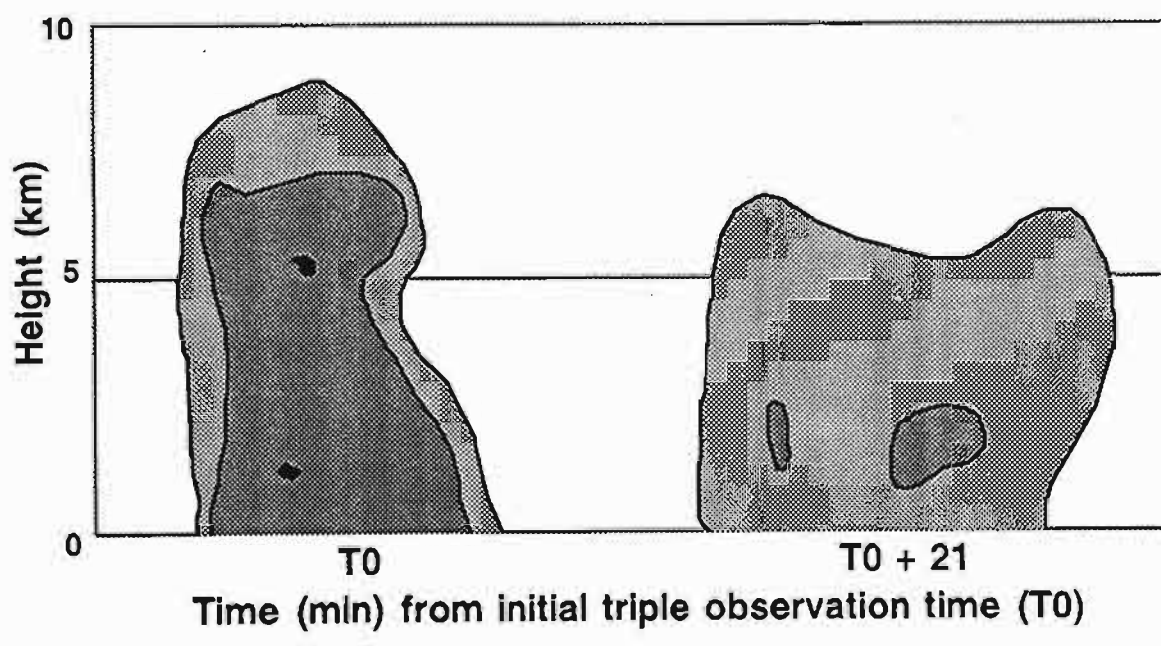
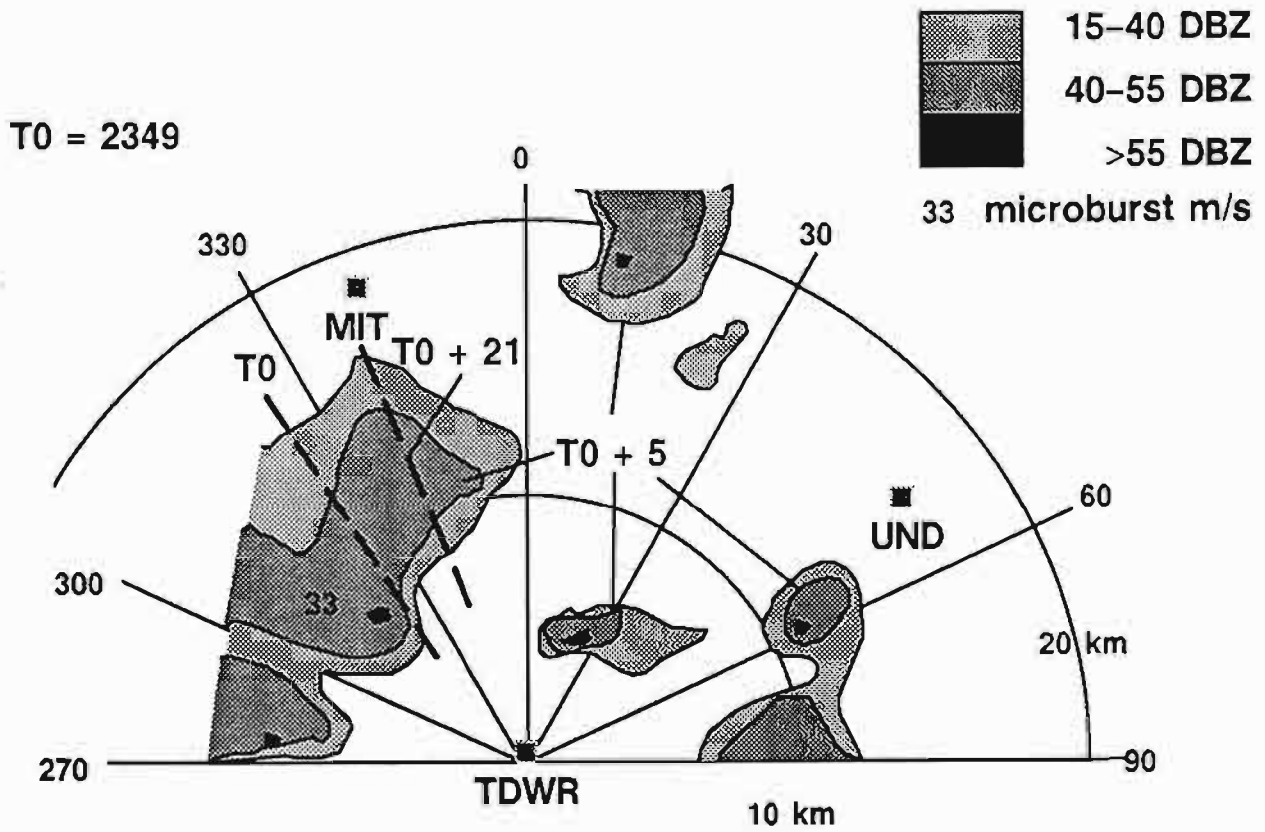

31 JULY 91

**Description:** Two thunderstorms moved into the triple Doppler region from the S. One moved out of the region and dissipated; the other produced a weak microburst on the edge of the region and then dissipated. One new cell developed on the MIT-UND baseline, but quickly moved out of the triple region. The sounding taken at 1659 GMT showed moderate south-southwesterly winds from the surface to 6 km, where the winds became light and variable to 13 km. The surface temperature was 28.7°C, the dew point was 22.9°C, the freezing level was 5.1 km, and the lifted condensation level was 0.5 km.

The accompanying sketch shows the two cells that moved into the triple Doppler region from the S. The cells are shown at  $T_0 + 5$  min, shortly before they began to dissipate.

**Triple Doppler Times:** 1746 - 1809 MIT/UND/TDWR

**Total Coverage Times:** 1604 - 2009, TDWR  
1619 - 1854, UND  
1537 - 2205, MIT

**Site Observations:** MB (11 m/s) 1740 (05/357), MCO ✓† (shown in the sketch at 1951)  
GF (10 m/s) 1753 (12/100), MCO

**Dual Doppler Times:** 1648 - 1746 UND/TDWR

**RHI Scans:** MIT  
1537 - 1725, SE/S/SW  
1815 - 1852, S/SW/W/NW  
1852 - 1923, SE/E/NE  
1923 - 1932, W/NW  
1932 - 1936, NE/E  
1945 - 2054, NE/E/SE/S  
2054 - 2205, W/NW  
TDWR  
1609 - 1610, 1615, 1620 - 1621, SE

**ASR-WSP data:** 1721 - 1728  
1735 - 1805  
1830 - 1832

**Sounding Times:** 1120, 1355, 1659

**Aircraft data:** None

ACARS data: Yes

Mesonet and LLWAS data: 1746 – 1809

Station	1	92%	16	99%
	2	0%	17	99%
	3	91%	18	88%
	4	93%	19	100%
	5	0%	20	0%
	6	0%	21	100%
	7	0%	22	100%
	8	0%	23	100%
	9	0%	24	0%
	10	78%	25	91%
	11	0%	26	100%
	12	0%	27	100%
	13	94%	28	100%
	14	0%	29	100%
	15	0%	30	100%

AWOS data: Yes

Interferometer data: None

Corona point data: 1746 – 1809  
Stations C33, C32, C25, C14, C3, C6, C1

31 JULY 91

T0 = 1746

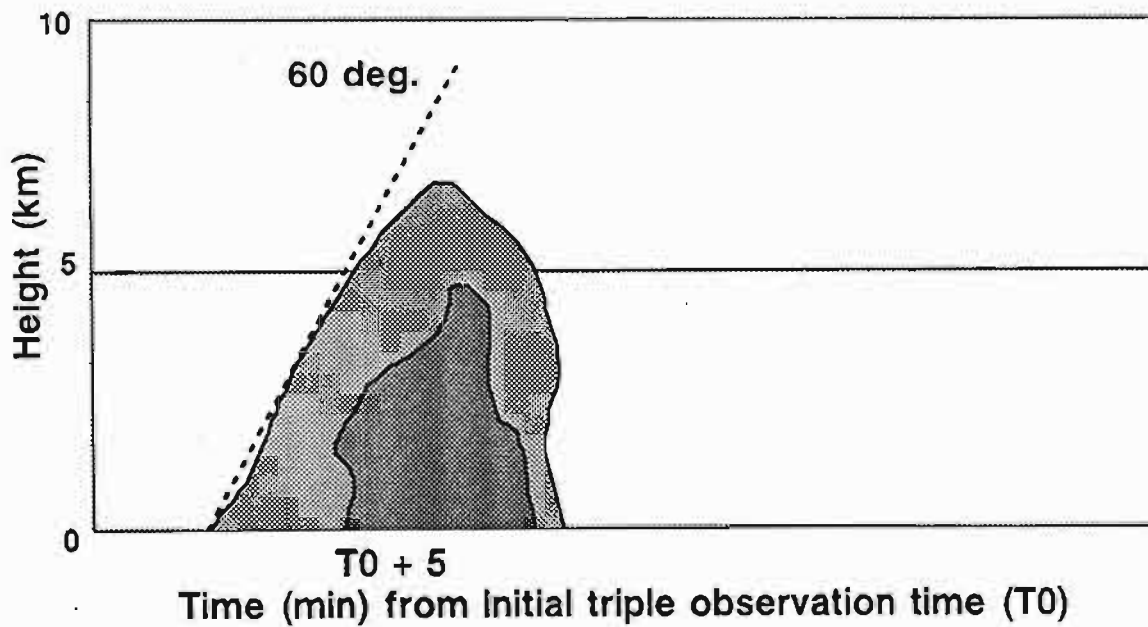
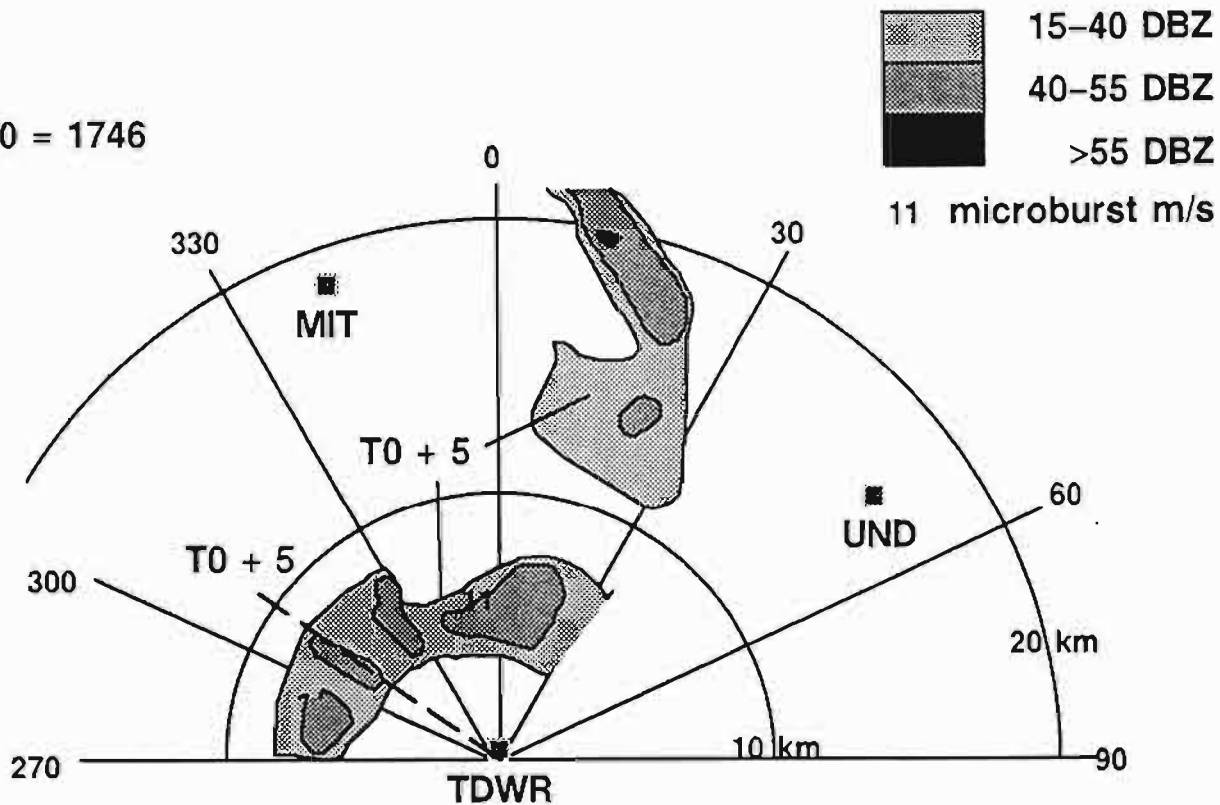

## 2 AUGUST 91

**Description:** A cluster of thunderstorms moved from the SW into the triple Doppler region, initiating new development ahead of the complex. The new cells merged with the complex, and continued the rapid movement to the NE. The system produced two moderate microbursts within the triple region. The sounding taken at 1953 GMT showed moderate southwesterly winds below the freezing level (4.9 km), with winds becoming increasingly stronger out of the ESE above. The surface temperature was 31.1°C, the dew point was 18.9°C, and the lifted condensation level was 1.1 km.

The accompanying sketch shows the complex as it moves into the triple Doppler region at  $T_0 + 34$  min, merges with new cells and begins to exit the region at  $T_0 + 63$  min.

**Triple Doppler Times:** 2027 - 2149 MIT/UND/TDWR

**Total Coverage Times:** 1841 - 2236, TDWR  
2001 - 2331, UND  
1742 - 0059, MIT

**Site Observations:** GF (8 m/s) 2056 (06/357), MCO  
MB (14 m/s) 2107 (06/009), MCO  
MB (14 m/s) 2116 (10/019), MCO ✓  
MB (13 m/s) 2126 (15/020)  
MB (17 m/s) 2130 (20/026), MCO ✓†  
GF (8 m/s) 2253 (04/001), MCO

**Dual Doppler Times:** 1845 - 1903 MIT/TDWR  
2001 - 2027 UND/TDWR

**RHI Scans:** MIT  
1836 - 1843, SW  
1912 - 2022, W  
2152 - 2359, NE  
UND  
2151 - 2200, 2200 - 2202, 2244 - 2247, 2252 - 2255  
2259 - 2302, 2307 - 2309, 2314 - 2317, 2321 - 2324  
2328 - 2331, E/SE  
TDWR  
2044, 2220 - 2221, W/SW

**ASR-WSP data:** 2039 - 2051  
2053 - 2131

**Sounding Times:** 1124, 1352, 1647, 1953

**Aircraft data:** None

**ACARS data:** Yes

**Mesonet and LLWAS data:** 2027 – 2149

Station	1	93%	16	98%
	2	0%	17	97%
	3	92%	18	97%
	4	94%	19	98%
	5	0%	20	96%
	6	0%	21	98%
	7	0%	22	98%
	8	0%	23	93%
	9	0%	24	0%
	10	84%	25	0%
	11	0%	26	100%
	12	92%	27	100%
	13	92%	28	100%
	14	0%	29	100%
	15	0%	30	100%

**AWOS data:** Yes

**Interferometer data:** None

**Corona point data:** 2027 – 2149

Stations C32, C25, C14, C3, C22, C6, C1



# 2 AUGUST 91

T0 = 2027

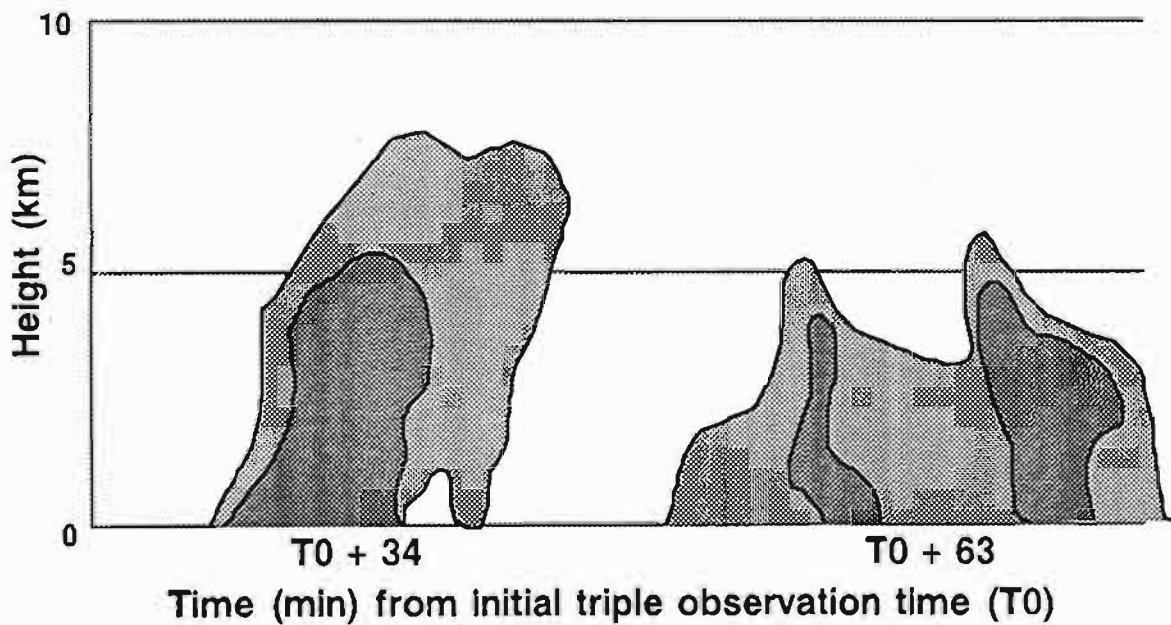
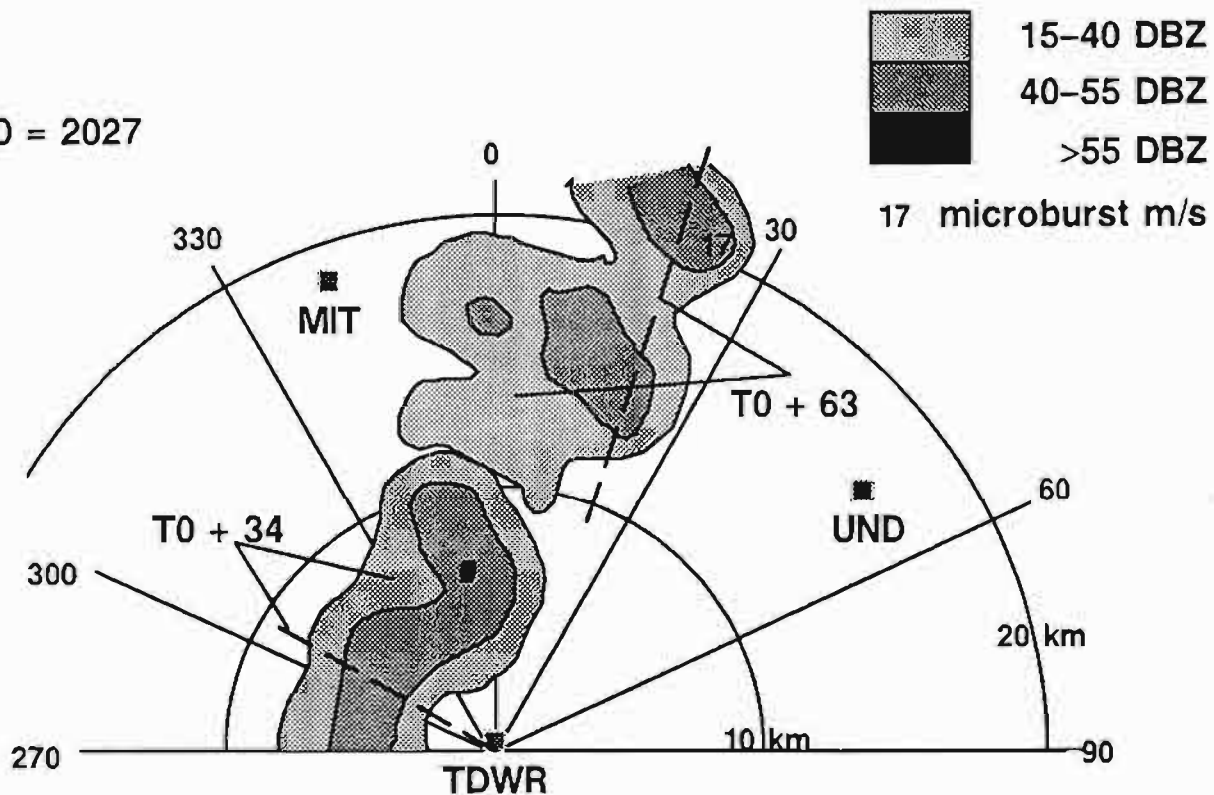

## 5 AUGUST 91

**Description:** A small airmass cell developed within the triple Doppler region and moved eastward. A second cell formed just to the north of the first, and the two cells merged. The multicell storm produced a microburst with a maximum differential velocity of 15 m/s. The sounding taken at 1657 GMT showed light and variable winds below the freezing level (4.7 km), and light to moderate northeasterly winds above. The surface temperature was 29.0°C, the dew point was 21.3°C, and the lifted condensation level was 0.7 km.

The accompanying sketch shows the initial cell at  $T_0 + 9$  min, which merged with a second cell at  $T_0 + 19$  min (not shown), and the complex at  $T_0 + 26$  min.

**Triple Doppler Times:** 1605 – 1704, 1729 – 1829 MIT/UND/TDWR

**Total Coverage Times:** 1450 – 1957, TDWR  
1459 – 1850, UND  
1535 – 2141, MIT

**Site Observations:** MB (12 m/s) 1528 (06/346), MCO  
GF (6 m/s) 1750 (13/005), MCO  
MB (14 m/s) 1755 (14/037) ✓†  
MB (11 m/s) 1803 (14/041)

**Dual Doppler Times:** 1459 – 1605, UND/TDWR  
1704 – 1729 UND/TDWR

**RHI Scans:** MIT  
1545 – 1604, SW  
1831 – 2135, NE/E/SE/SW  
TDWR  
1559 – 1835, intermittent between volume scans

**ASR-WSP data:** 1715 – 1737  
1739 – 1805

**Sounding Times:** 1118, 1358, 1657, 1946

**Aircraft data:** None

**ACARS data:** Yes

**Mesonet and LLWAS data: 1605 – 1704**

Station	1	94%	16	100%
	2	0%	17	97%
	3	92%	18	95%
	4	0%	19	100%
	5	0%	20	99%
	6	0%	21	100%
	7	0%	22	100%
	8	0%	23	100%
	9	0%	24	0%
	10	87%	25	100%
	11	0%	26	100%
	12	92%	27	100%
	13	85%	28	100%
	14	0%	29	100%
	15	0%	30	100%

**1729 – 1829**

Station	1	93%	16	92%
	2	0%	17	89%
	3	92%	18	89%
	4	0%	19	91%
	5	0%	20	90%
	6	0%	21	91%
	7	0%	22	90%
	8	0%	23	91%
	9	0%	24	0%
	10	88%	25	100%
	11	0%	26	100%
	12	93%	27	100%
	13	94%	28	100%
	14	0%	29	100%
	15	0%	30	100%

**AWOS data: Yes**

**Interferometer data: None**

**Corona point data: 1605 – 1704**

None

1729 - 1829

Stations C32, C25, C24, C33, C3, C22, C6

# 5 AUGUST 91

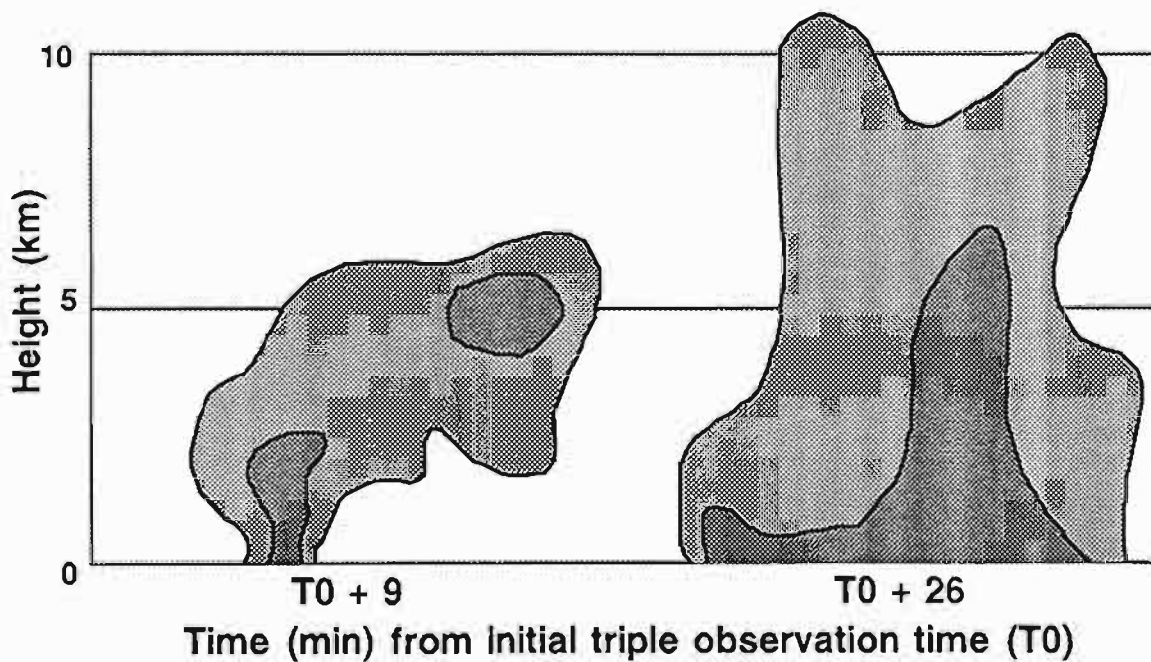
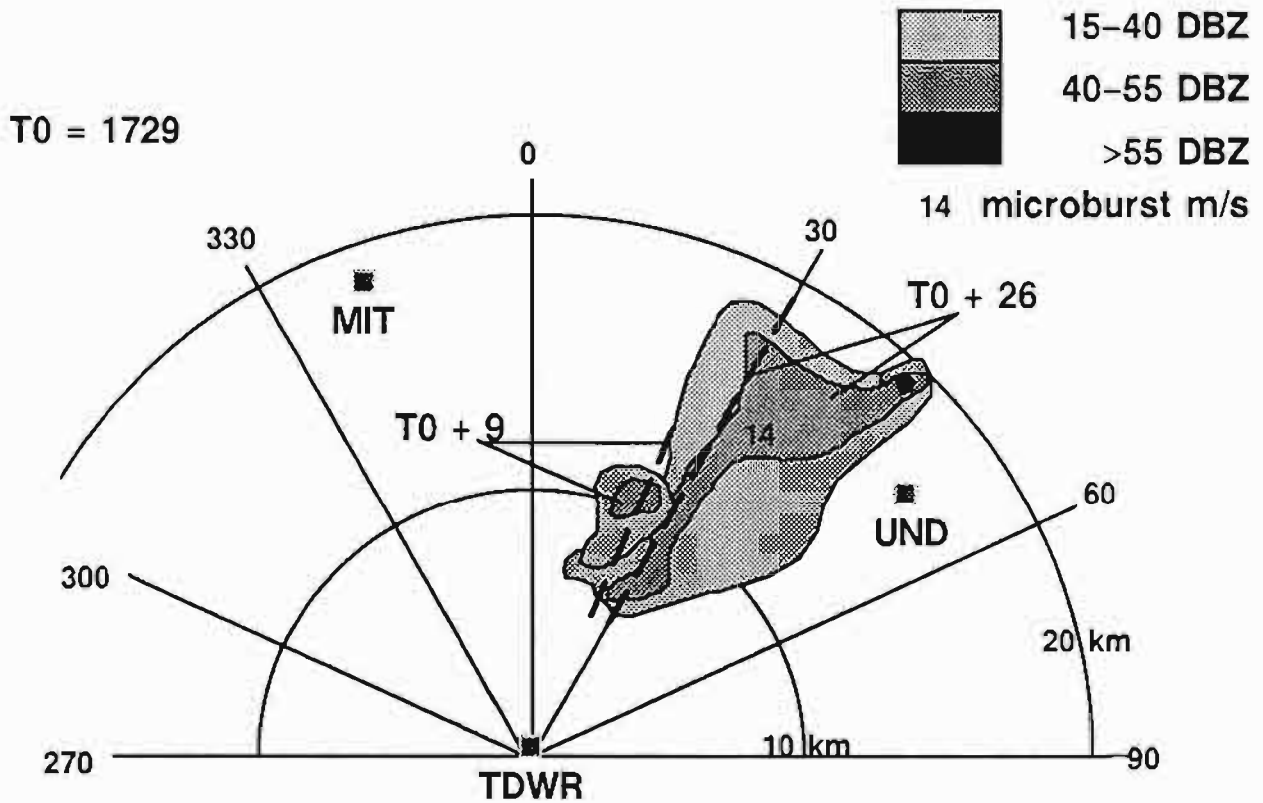

## 9 AUGUST 91

**Description:** A southeastward moving gust front at the leading edge of an old thunderstorm outflow triggered a new, rapidly growing cell in the triple Doppler region. The storm merged with other newly developed, rapidly growing cells over the airport to form a large multicell storm. The entire storm complex drifted slowly from NW to SE. The strongest surface outflow of the entire data collection period was observed (45 m/s). The sounding taken at 1935 GMT showed northwesterly winds below the freezing level (4.9 km), and light and variable winds above. The surface temperature was 32°C, the dew point was 20.1°C, and the lifted condensation level was 1.0 km.

The accompanying sketch shows the initial surface cell at  $T_0 - 9$  min developing into the main multicell storm at  $T_0 + 22$  min. The RHI at  $T_0 + 15$  min reveals multiple cells. This storm produced the 45 m/s outflow at  $T_0 + 31$  min (not shown). The storm is shown in the dissipating stage at  $T_0 + 51$  min.

**Triple Doppler Times:** 1912 - 1918 MIT/UND/TDWR  
1923 - 2038

**Total Coverage Times:** 1701 - 2313, TDWR  
1815 - 2311, UND  
1850 - 2250, MIT

**Site Observations:** GF (10 m/s) 1909 (08/357), MCO  
MB (40 m/s) 1931 (12/353), MCO ✓  
MB (21 m/s) 1931 (11/338)  
MB (45 m/s) 1943 (08/017), MCO ✓† (shown in the sketch at 1934)  
MB (21 m/s) 1944 (05/020), MCO ✓  
MB (16 m/s) 1945 (09/019), MCO ✓  
MB (31 m/s) 1947 (06/011), MCO ✓  
MB (18 m/s) 1947 (29/060), MCO  
MB (27 m/s) 1951 (05/059) ✓  
MB (30 m/s) 1958 (07/049) ✓  
MB (20 m/s) 1959 (09/068) ✓  
GF (9 m/s) 2214 (07/351), MCO

**Dual Doppler Times:** 1818 - 1912, UND/TDWR  
1918 - 1923, UND/TDWR, over the airport

**RHI Scans:** MIT  
1850 - 1912 W  
1920 - 1923 SE,  
2043 - 2250 E,NE

UND  
 2308 – 2311 N  
 TDWR  
 1848 – 2244, intermittent between volume scans

**ASR-WSP data:** 1908 – 1950  
 1951 – 2011

**Sounding Times:** 1138, 1408, 1645, 1935

**Aircraft data:** None

**ACARS data:** Yes

**Mesonet and LLWAS data:** 1912 – 1918

Station	1	95%	16	100%
	2	0%	17	0%
	3	0%	18	100%
	4	0%	19	100%
	5	0%	20	100%
	6	0%	21	100%
	7	0%	22	100%
	8	0%	23	100%
	9	0%	24	0%
	10	92%	25	100%
	11	0%	26	100%
	12	89%	27	100%
	13	92%	28	100%
	14	0%	29	100%
	15	0%	30	100%

1923 – 2038

Station	1	93%	16	84%
	2	0%	17	0%
	3	0%	18	48%
	4	0%	19	93%
	5	0%	20	93%
	6	0%	21	93%
	7	0%	22	92%
	8	0%	23	93%
	9	0%	24	0%

9	0%	24	0%
10	88%	25	100%
11	0%	26	100%
12	92%	27	100%
13	88%	28	100%
14	0%	29	100%
15	0%	30	100%

**AWOS data:** Yes

**Interferometer data:** None

**Corona point data:** 1912 – 1918

Stations C3, C35, C6 (bad), C1

1923 – 2038

Stations C3, C22 (some bad), C35, C6 (some bad), C1



# 9 AUGUST 91

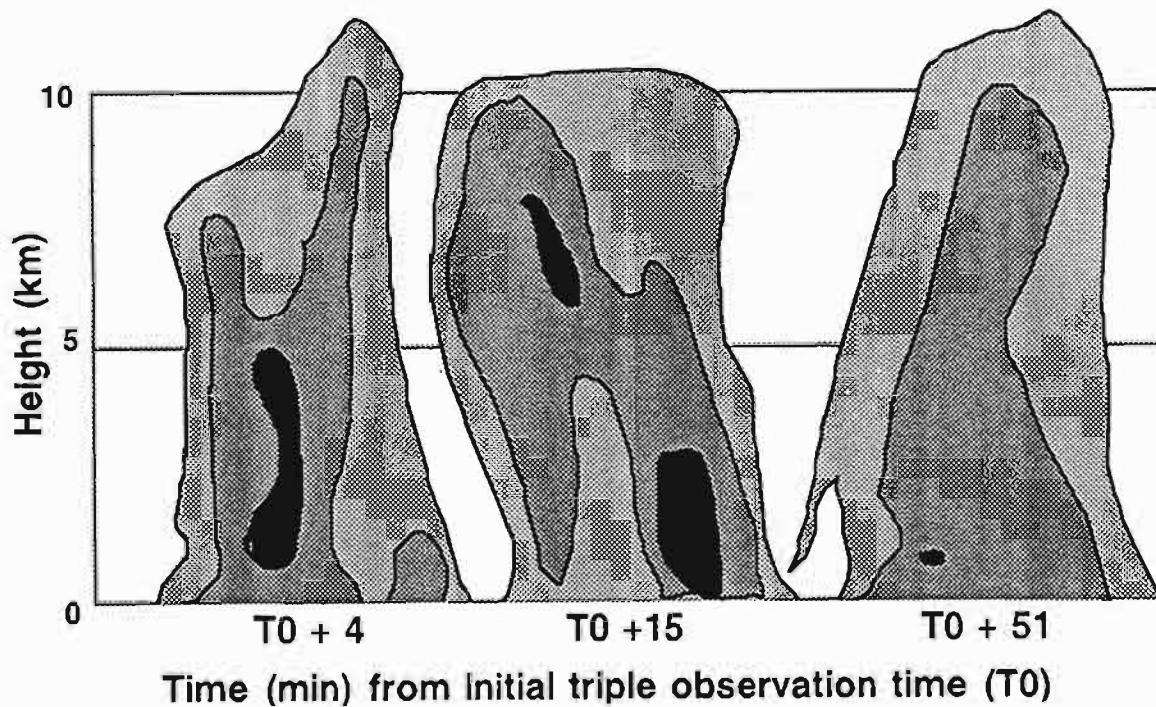
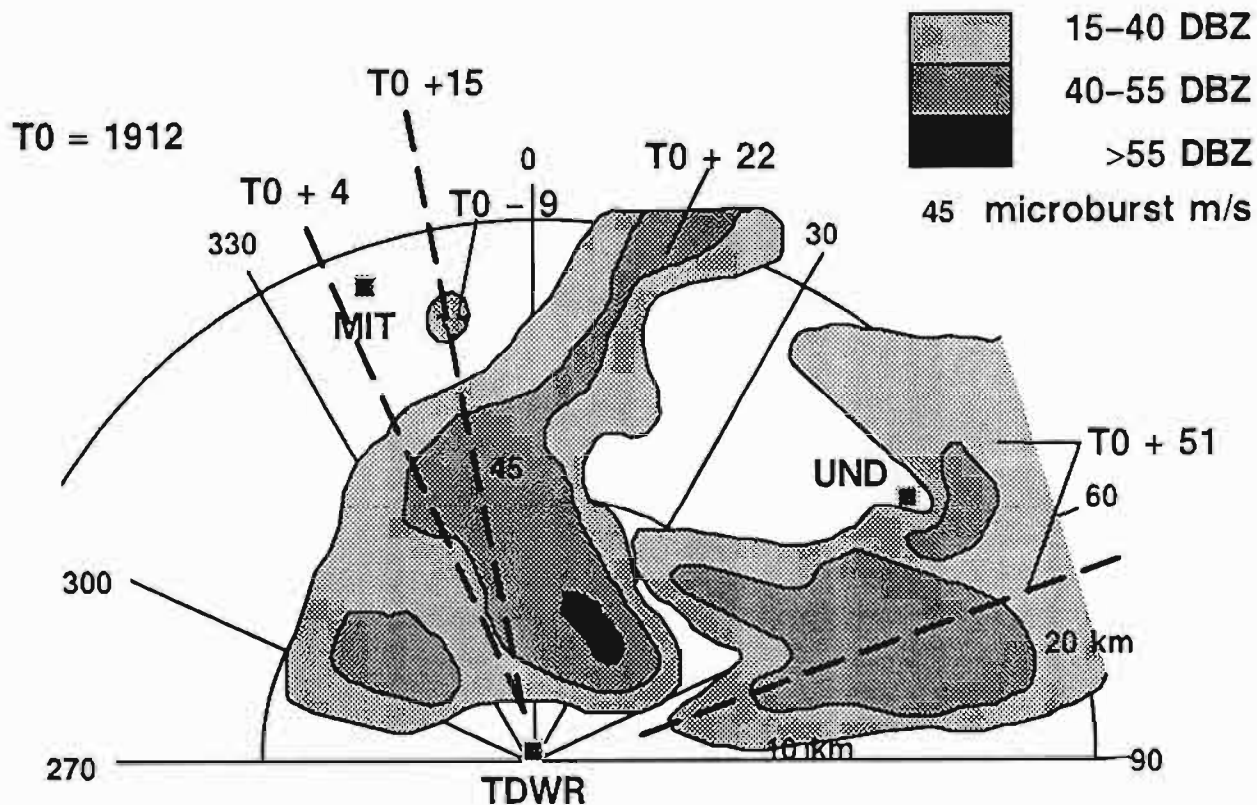

## 10 AUGUST 91

**Description:** A gust front passed through the triple Doppler region from W to E in advance of a large thunderstorm. Behind the gust front new cells developed; a few merged with the older thunderstorm moving E, another formed a second large thunderstorm to the S of the first. They began to dissipate after exiting the triple Doppler region, while new cells continued to develop behind the gust front in advance of the dissipating cells. The sounding taken at 1943 GMT showed light to moderate west-southwesterly winds below the freezing level (5.2 km), and light southeasterly winds above. The surface temperature was 31.9°C, the dew point was 20.7°C, and the lifted condensation level was 1.0 km.

The accompanying sketch shows the initial thunderstorm moving into the triple region, and a new cell forming in advance of the larger cell at  $T_0$ . As the pair moved to the E, they merged, and a second cell developed to the S at  $T_0 + 28$  min.

**Triple Doppler Times:** 2033 - 2129 MIT/UND/TDWR  
2211 - 2317

**Total Coverage Times:** 1512 - 2333, TDWR  
1953 - 2322, UND  
1709 - 0111, MIT

**Site Observations:** MB (22 m/s) 2050 (21/350), MCO  
GF (7 m/s) 2053 (12/054), MCO  
MB (16 m/s) 2059 (11/024), MCO ✓  
MB (32 m/s) 2101 (14/015) ✓†  
MB (20 m/s) 2105 (13/028) ✓  
MB (17 m/s) 2111 (16/029) ✓  
MB (14 m/s) 2114 (14/051) ✓  
GF (7 m/s) 2221 (07/026), MCO  
MB (24 m/s) 2223 (10/058)  
MB (20 m/s) 2231 (04/016), MCO  
MB (23 m/s) 2238 (07/040), MCO ✓  
MB (23 m/s) 2244 (09/035)

**Dual Doppler Times:** 1953 - 2033 UND/TDWR

**RHI Scans:** MIT  
1746 - 2023 W  
2141 - 2211 SW,NE  
2321 - 0111 E,NE  
TDWR  
1908 - 2302, intermittent between volume scans

ASR-WSP data: 2024 – 2049  
 2050 – 2120  
 2156 – 2210  
 2212 – 2252

Sounding Times: 1120, 1344, 1654, 1943

Aircraft data: None

ACARS data: Yes

Mesonet and LLWAS data: 2033 – 2129

Station	1	92%	16	88%
	2	0%	17	0%
	3	0%	18	68%
	4	0%	19	88%
	5	0%	20	86%
	6	0%	21	88%
	7	0%	22	88%
	8	0%	23	88%
	9	0%	24	0%
	10	86%	25	100%
	11	0%	26	100%
	12	92%	27	100%
	13	93%	28	100%
	14	0%	29	100%
	15	0%	30	100%

2111 – 2317

Station	1	92%	16	88%
	2	0%	17	0%
	3	0%	18	68%
	4	0%	19	88%
	5	0%	20	86%
	6	0%	21	88%
	7	0%	22	88%
	8	0%	23	88%
	9	0%	24	0%
	10	86%	25	100%
	11	0%	26	100%
	12	92%	27	100%

13	93%	28	100%
14	0%	29	100%
15	0%	30	100%

**AWOS data:** None

**Interferometer data:** None

**Corona point data:** 2033 - 2129

Stations C32, C24, C33, C3, C22 (some bad), C35, C6, C1

# 10 AUGUST 91

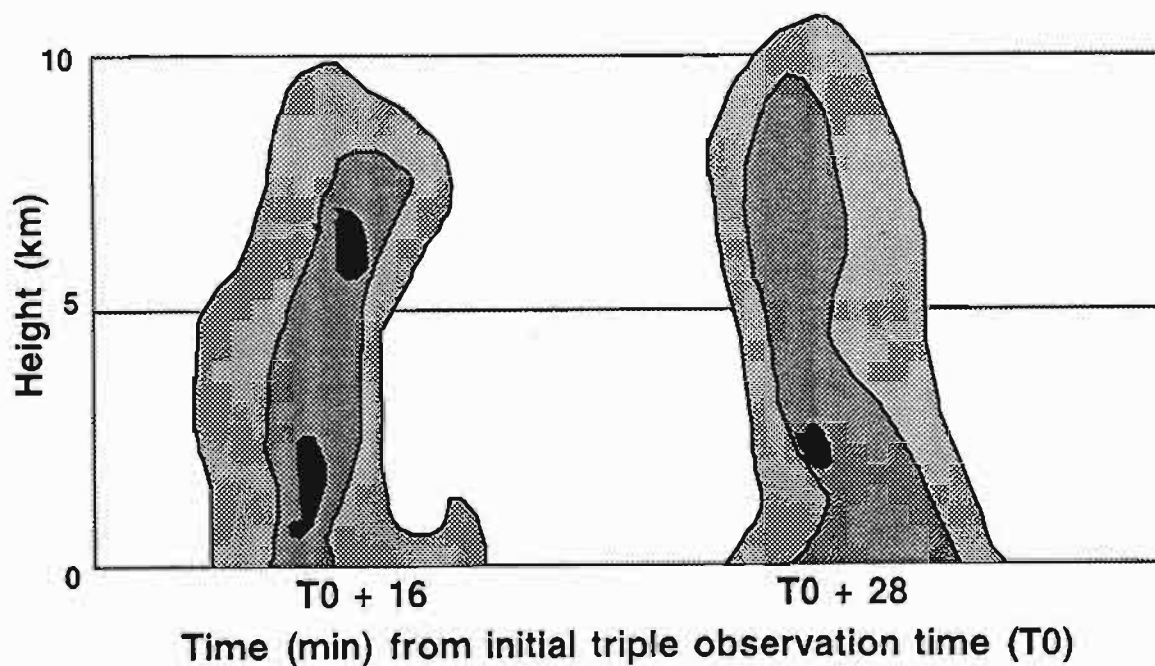
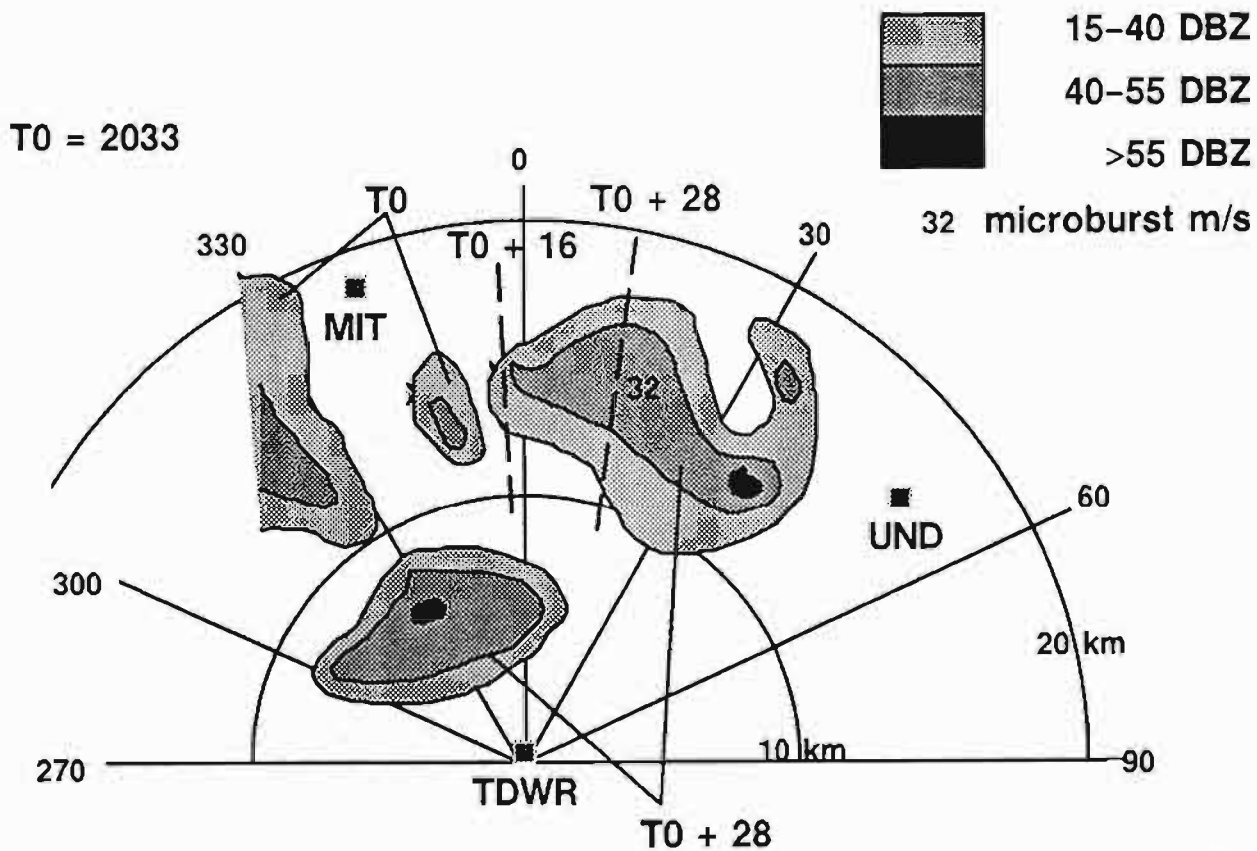

## 12 AUGUST 91

**Description:** A few isolated thunderstorms developed on this day, but only one formed within the triple Doppler region. The cell formed to the NE of the TDWR testbed, and moved to the NE while continuing to grow. It merged with the remains of another small cell, and the resultant cell produced an 18 m/s microburst. A second small thunderstorm formed to the W of this cell, but did not merge with it. The sounding taken at 1950 GMT showed light southwesterly winds below the freezing level (4.9 km), and light and variable winds above. The surface temperature was 31.2°C, the dew point was 19.8°C, and the lifted condensation level was 1.0 km.

The accompanying sketch shows the original position of the cell at  $T_0 + 8$  min, and its position at  $T_0 + 46$  min, after it merges with the remains of another cell. A second small cell present at the time is also shown.

**Triple Doppler Times:** 2207 - 2324 MIT/UND/TDWR

**Total Coverage Times:** 2106 - 2337, TDWR  
2021 - 2340, UND  
2012 - 0118, MIT

**Site Observations:** GF (5 m/s) 2143 (16/003), MCO  
MB (17 m/s) 2253 (17/006), MCO ✓†  
MB (12 m/s) 2301 (14/001), MCO

**Dual Doppler Times:** 2324 - 2337 UND/TDWR

**RHI Scans:** MIT  
2017 - 2153, NW  
0022 - 0118, SE/S/SW  
TDWR  
2140 - 2337, intermittent between volume scans

**ASR-WSP data:** 2251 - 2311

**Sounding Times:** 1117, 1428, 1648, 1950

**Aircraft data:** None

**ACARS data:** Yes

**Mesonet and LLWAS data:** 2207 - 2324

Station	1	92%	16	100%
	2	0%	17	0%
	3	0%	18	0%
	4	0%	19	100%
	5	0%	20	100%
	6	0%	21	100%
	7	0%	22	100%
	8	95%	23	100%
	9	0%	24	0%
	10	0%	25	99%
	11	0%	26	99%
	12	93%	27	99%
	13	0%	28	99%
	14	0%	29	99%
	15	0%	30	99%

**AWOS data:** Yes

**Interferometer data:** None

**Corona point data:** 2207 - 2324  
Stations C33, C3, C22 (bad), C1

# 12 AUGUST 91

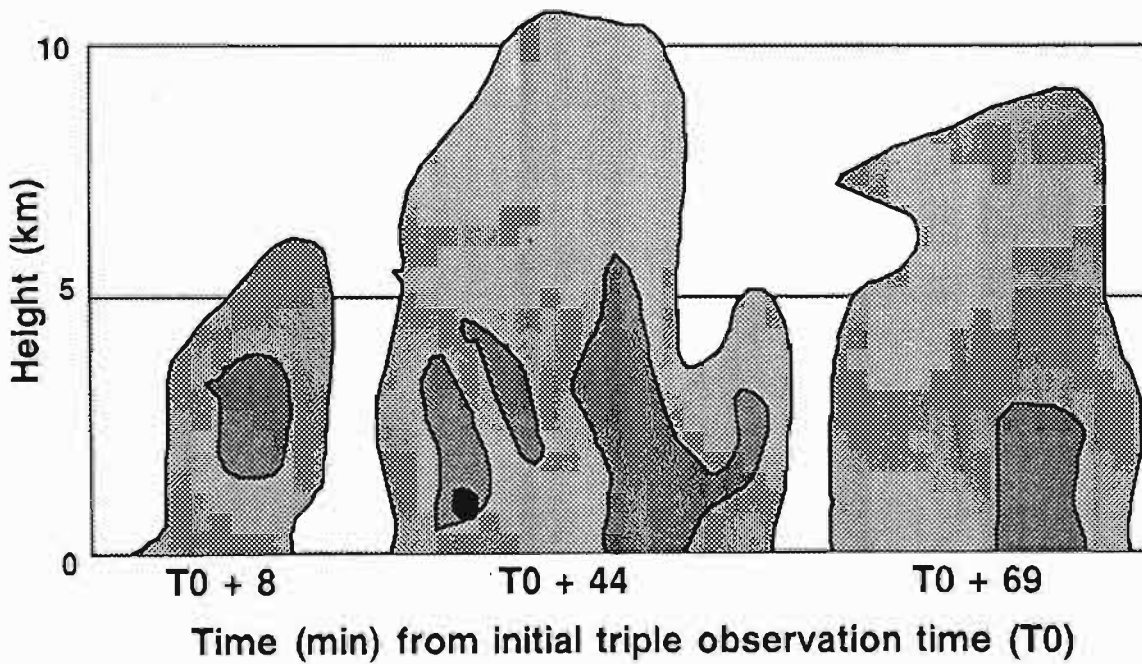
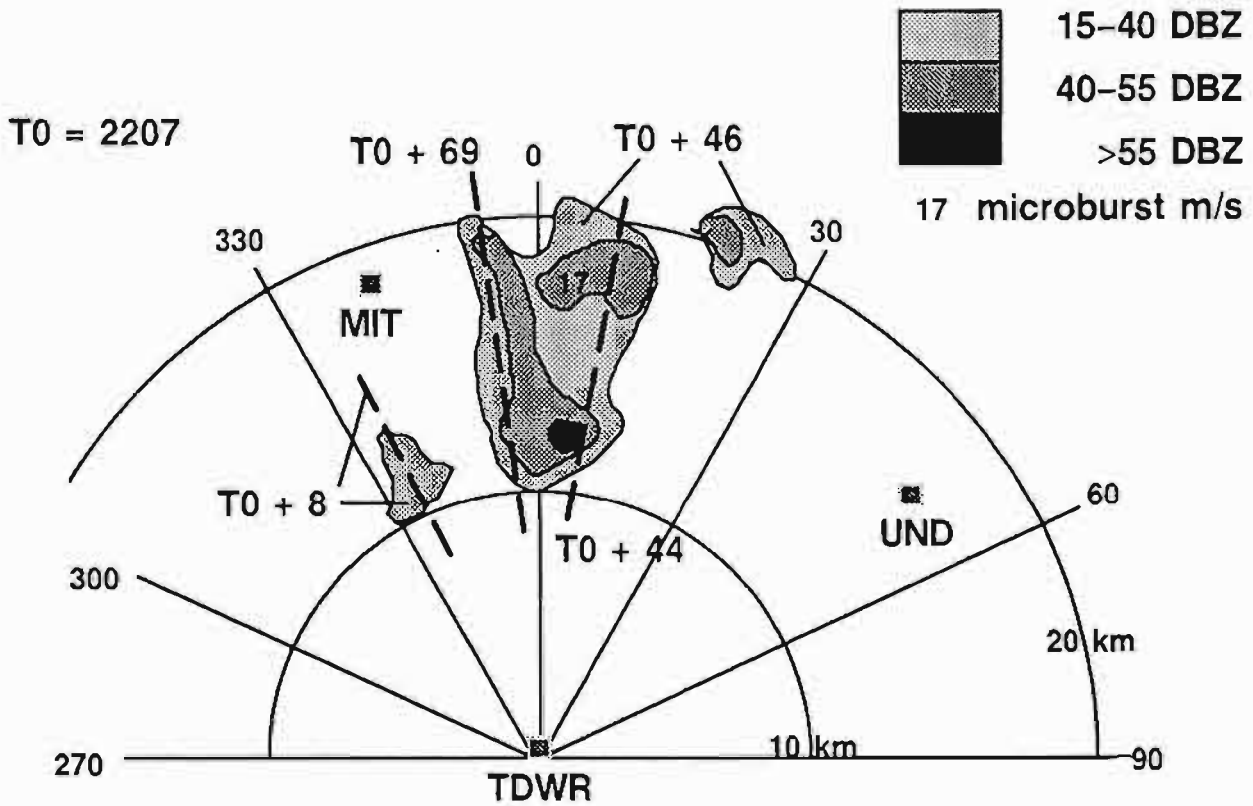



## 15 AUGUST 91

**Description:** A gust front moved into the triple Doppler region from the NW followed by a small cluster of thunderstorms. After passing into the triple sector, a burst of new development took place around the initial cells, forming a broad multicell line. Ahead of the line and over the airport, another cell developed which eventually merged with the line. The line then began to broaden; some parts grew and other parts dissipated. This process continued for 45 minutes, until most of the cells dissipated into stratiform rain. Two strong outflows were produced by this system, one 22 m/s and the other 28 m/s. Eventually this system produced an interesting feature: a long surface divergence line that remained for at least an hour. The sounding taken at 1939 GMT showed strong northwesterly winds at the surface, with light southeasterly winds above. The surface temperature was 26.5°C, the dew point was 17.8°C, the freezing level was 4.7 km, and the lifted condensation level was 0.8 km.

The accompanying sketch shows the multicell complex as it enters the triple Doppler region and the burst of development that is taking place. The system is shown at  $T_0 + 63$  min, the time of maximum outflow. The system continues to expand after this time, and a part of it is shown at  $T_0 + 98$  min.

**Triple Doppler Times:** 1849 - 2028 MIT/UND/TDWR

**Total Coverage Times:** 1728 - 2306, TDWR  
1814 - 2042, UND  
1704 - 2218, MIT

**Site Observations:** GF (6 m/s) 1830 (14/350), MCO  
MB (24 m/s) 1851 (12/346), MCO  
MB (12 m/s) 1904 (15/346)  
MB (12 m/s) 1908 (13/351)  
MB (19 m/s) 1920 (16/010)  
MB (17 m/s) 1944 (07/349), MCO ✓  
MB (12 m/s) 1948 (13/034) ✓  
MB (22 m/s) 1952 (09/356), MCO ✓†  
MB (21 m/s) 1952 (08/020), MCO ✓  
MB (22 m/s) 2003 (09/030) ✓

**Dual Doppler Times:** 1816 - 1849 UND/TDWR

**RHI Scans:** MIT  
1717 - 1843, W/NW/N  
2030 - 2217, NE/E/SE

UND  
1816, NW  
TDWR  
1825 - 2026, intermittent between volume scans  
2206, 2212 - 2213, 2218 - 2219, 2225, E/NE

**ASR-WSP data:** 1846 - 1919  
1920 - 2005

**Sounding Times:** 1111, 1401, 1656, 1939

**Aircraft data:** None

**ACARS data:** Yes

**Mesonet and LLWAS data:** None

**AWOS data:** Yes

**Interferometer data:** None

**Corona point data:** None

# 15 AUGUST 91

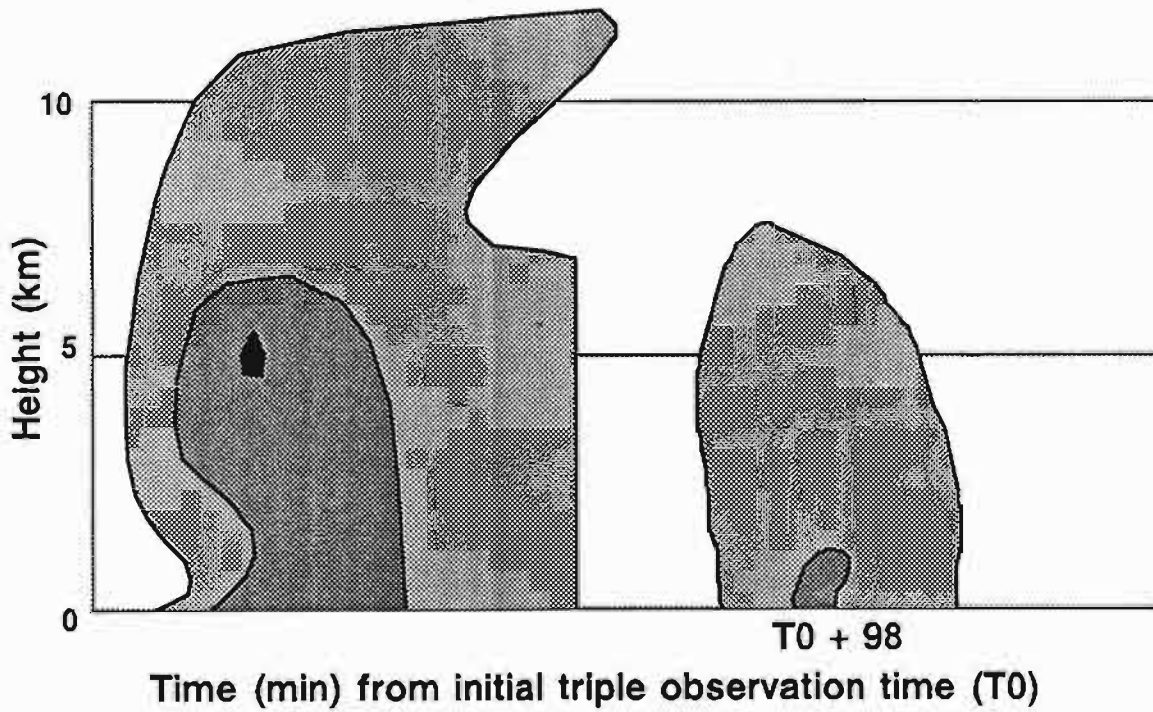
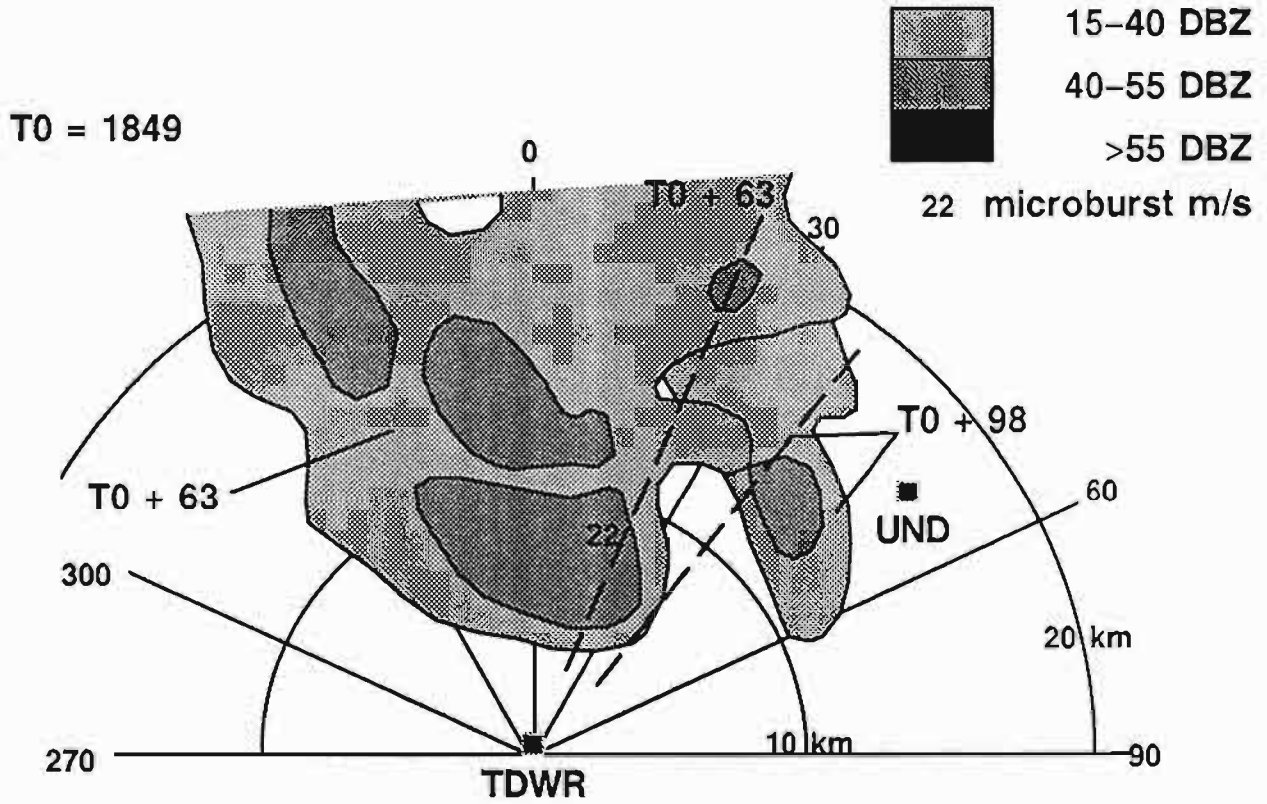

## 19 AUGUST 91

**Description:** A few small airmass thunderstorms formed on this day. The two that formed earliest in the triple period did not grow to any great extent, but they did produce weak microbursts as they exited the triple Doppler region. Later in the triple period, a pair of westward moving cells merged, and passed just to the north of the TDWR testbed. As the thunderstorm passed the radar, it began to dissipate after producing a 16 m/s outflow. The sounding taken at 1656 GMT showed light to moderate southerly winds at the surface, and moderate westerly winds above the surface layer to 7 km. Above that, the winds were light to moderate from the north. The freezing level was 4.9 km, the surface temperature was 29.8°C, the dew point was 21.2°C, and the lifted condensation level was 0.8 km.

The accompanying sketch shows the three thunderstorms that passed through the triple Doppler region on this day. The two cells that formed earliest in the triple period are shown as they appeared before moving outside the triple region, at  $T_0 + 1$  min and  $T_0 + 13$  min respectively. Two cells that formed later in the triple period merged and are shown at  $T_0 + 64$  min, and the resultant thunderstorm is shown at  $T_0 + 87$  min.

**Triple Doppler Times:** 1712 - 1903, MIT/UND/TDWR

**Total Coverage Times:** 1651 - 2151, TDWR  
1702 - 1929, UND  
1501 - 0151, MIT

**Site Observations:** MB (12 m/s) 1720 (16/024)  
GF (5 m/s) 1821 (13/016), MCO  
MB (14 m/s) 1839 (06/355), MCO ✓†

**Dual Doppler Times:** 1903 - 1919 MIT/TDWR

**RHI Scans:** MIT  
1505 - 1705, NE/SE  
1937 - 1942, NE/E/SE  
UND  
1904 - 1914, E/SE  
1919 - 1948, intermittent between volume scans  
TDWR  
1711 - 1751, 1830 - 1910, 1925 - 1938, 2052 - 2151, intermittent between volume scans

**ASR-WSP data:** 1714 - 1718  
1831 - 1855

**Sounding Times:** 1130, 1351, 1656, 1955

**Aircraft data:** None

**ACARS data:** Yes

**Mesonet and LLWAS data:** None

**AWOS data:** Yes

**Interferometer data:** None

**Corona point data:** 1712 - 1903  
Stations C14, C3, C6

# 19 AUGUST 91

T0 = 1712

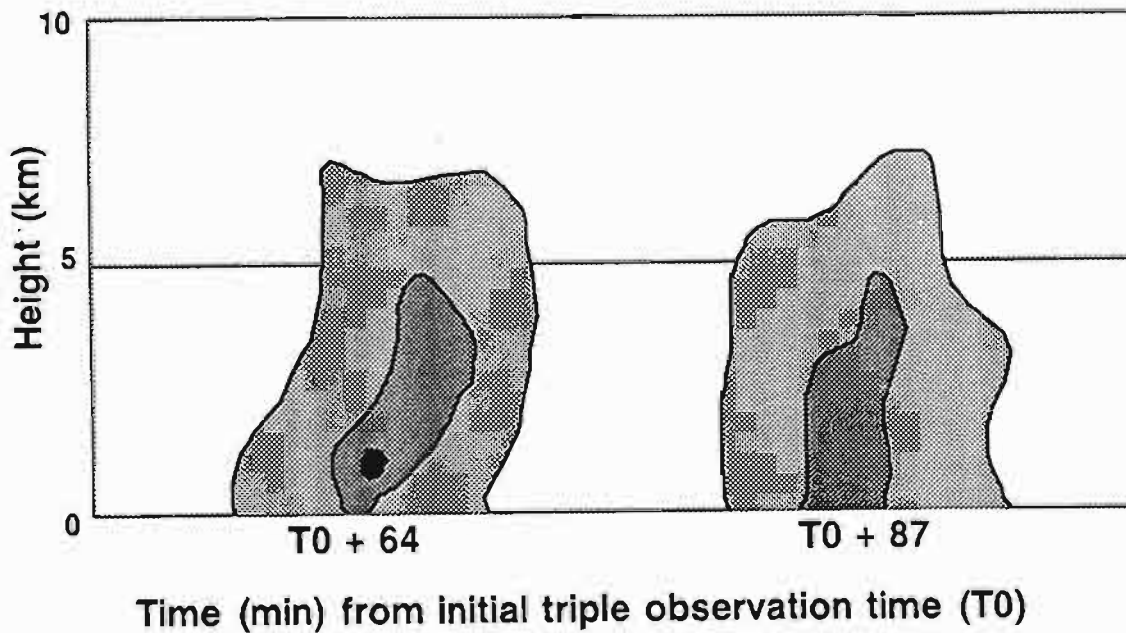
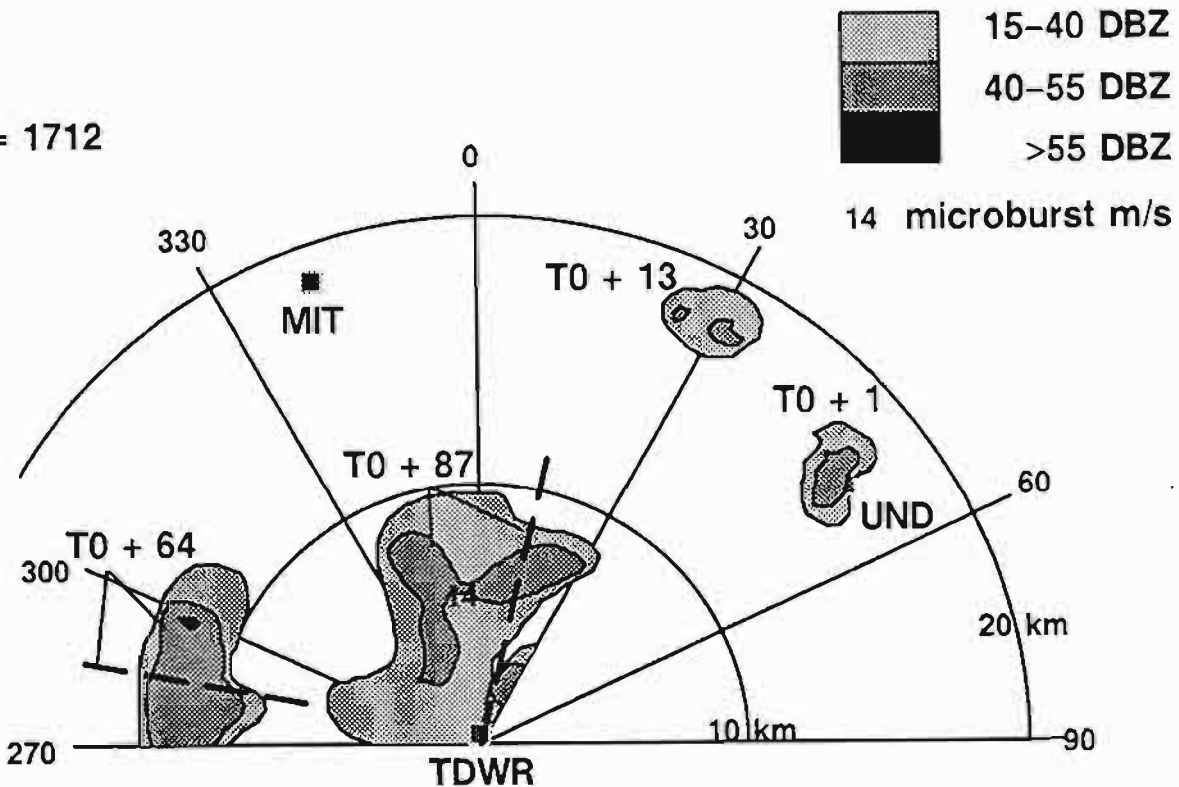

## 24 AUGUST 91

**Description:** Numerous showers and thunderstorms moved rapidly from the S through the triple Doppler region. A few thunderstorms developed in the triple region, but quickly moved out of the region. One large multicell complex moved rapidly into the region from the S, developing further as it passed through. The complex produced two weak microbursts within the triple sector. A large band of thunderstorms passed to the E of the UND radar, just outside of the triple region. The sounding taken at 1658 GMT showed moderate southerly flow from the surface to 13 km. The surface temperature was 28.1°C, the dew point was 20.6°C, the freezing level was 4.9 km, and the lifted condensation level was 0.7 km.

The accompanying sketch shows the multicell complex as it develops and moves through the triple Doppler region. At  $T_0 + 130$  min the complex is just entering the triple region, and by  $T_0 + 142$  min the complex has expanded and reached the northern edge of the region. (The southern portion of the storm is not shown so as not to obscure the data at  $T_0 + 130$  min.) The RHIs show the vertical extent of the complex at these two times.

**Triple Doppler Times:** 1644 – 1929, MIT/UND/TDWR

**Total Coverage Times:** 1623 – 2042, TDWR  
1641 – 1937, UND  
1624 – 2051, MIT

**Site Observations:** GF (6 m/s) 1857 (10/348), MCO  
MB (14 m/s) 1859 (06/315), MCO ✓† (shown in the sketch at 1906)  
MB (10 m/s) 1909 (07/003), MCO

**Dual Doppler Times:** 1929 – 1944 MIT/TDWR

**RHI Scans:** MIT  
1628 – 1642, SW  
1956, SE  
2011 – 2051, SE/NE  
UND  
1929 – 1930, 1933 – 1936, SW  
TDWR  
1723 – 1747, 1814 – 1938, intermittent between volume scans  
1944, NE

**ASR–WSP data:** None

**Sounding Times:** 1147, 1401, 1658

**Aircraft data:** Westinghouse BAC1-11 on site for flight tests of forward looking radar with MB detection capability.

**ACARS data:** Yes

**Mesonet and LLWAS data:** None

**AWOS data:** Yes

**Interferometer data:** None

**Corona point data:** 1644 - 1929

Stations C14, C25, C24, C33, C28, C3, C22, C6, C1



# 24 AUGUST 91

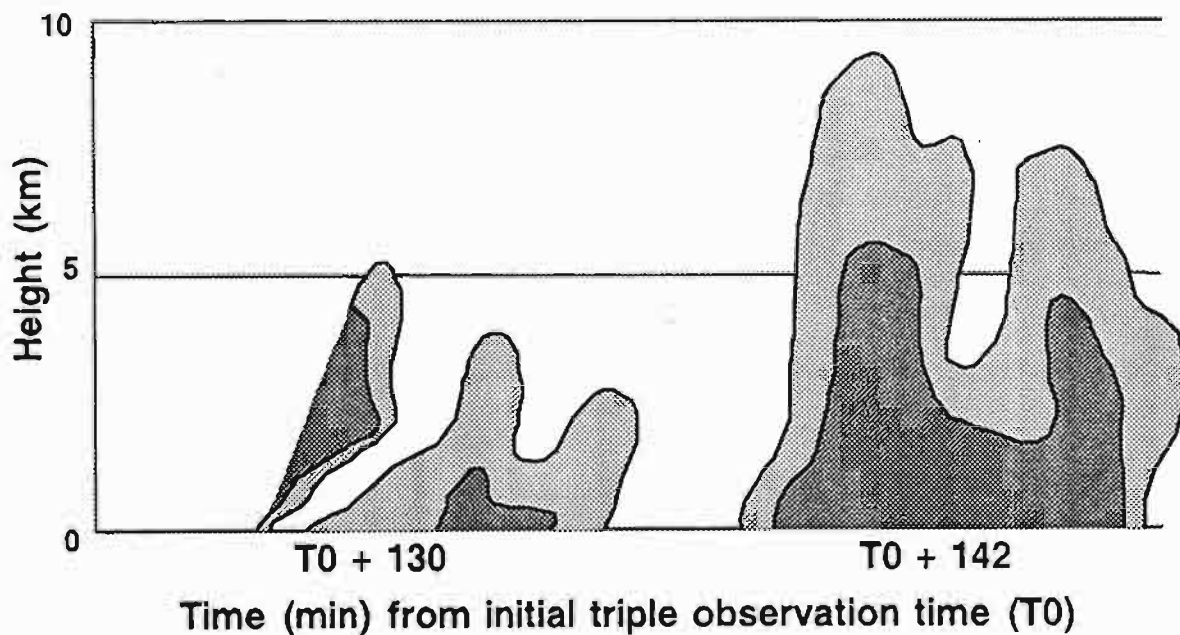
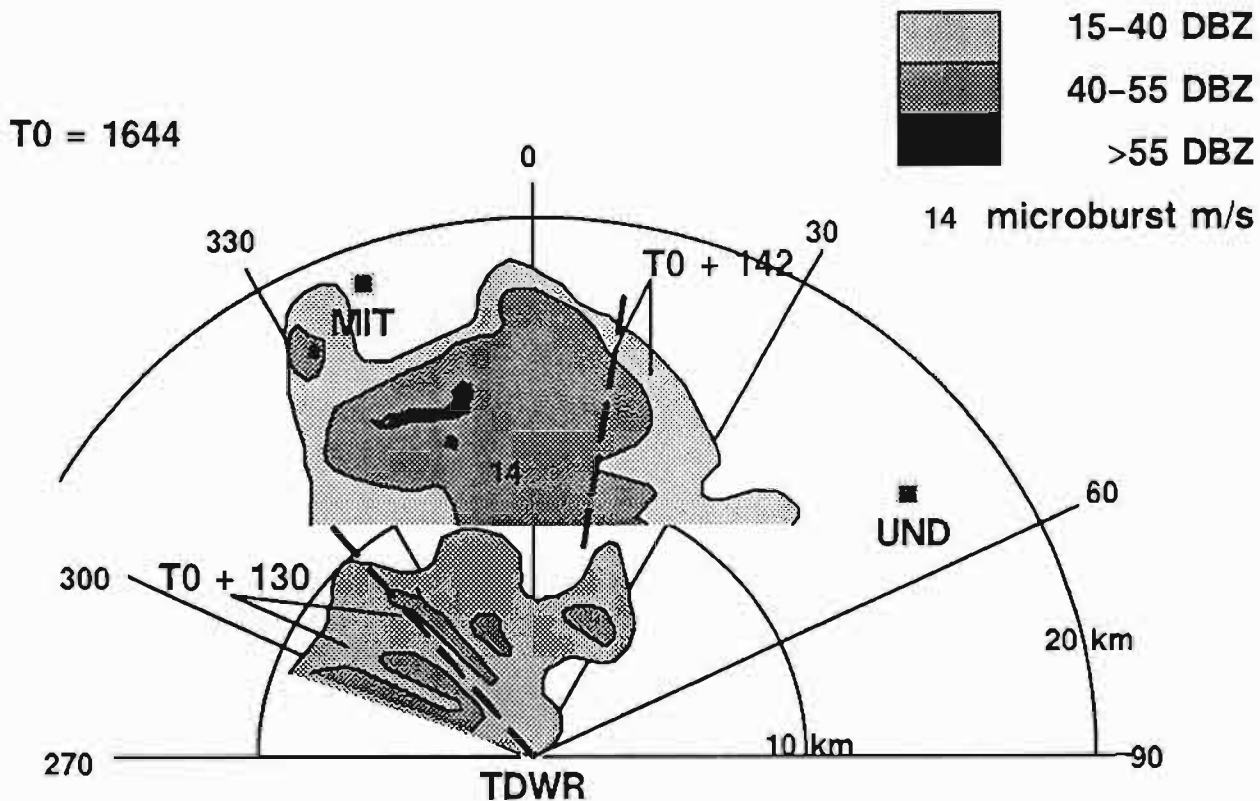

## 25 AUGUST 91

**Description:** A gust front moved through the triple Doppler region from W to E, triggering rapid development behind it. A long line of thunderstorms formed in the triple region with the same orientation as the front, and developed even further as it moved to the E. The line produced several outflows within the triple region, but only one was strong enough to be classified as a microburst. The sounding taken at 1944 GMT showed light easterly flow at the surface, which shifted to moderate southwesterly flow above the surface layer to the freezing layer (5.8 km). The winds were strongest from the SE, just above the freezing layer, and became lighter above. The surface temperature was 25.8°C, the dew point was 22.4°C, and the lifted condensation level was 0.3 km.

The accompanying sketch shows the initial cells that formed behind the gust front at  $T_0 + 7$  min. These cells expanded and grew into a long, strong line of thunderstorms at  $T_0 + 67$  min.

**Triple Doppler Times:** 2121 - 2233, MIT/UND/TDWR

**Total Coverage Times:** 1614 - 2312, TDWR  
1746 - 2317, UND  
1514 - 2314, MIT

**Site Observations:** GF (6 m/s) 1839 (11/015), MCO  
GF (7 m/s) 2115 (05/030), MCO  
MB (11 m/s) 2215 (13/049) ↗† (shown in the sketch at 2228)  
MB (10 m/s) 2242 (11/346), MCO

**Dual Doppler Times:** 2102 - 2121 UND/TDWR  
2233 - 2314 MIT/TDWR

**RHI Scans:** MIT  
1516 - 1650, NE/E/N  
1655 - 1656, 1702, 1705 - 1706, SE  
1711 - 1811, NE/SE  
1811 - 1937, NW  
1938 - 2022, SW  
2030 - 2117, SW/S  
UND  
2233 - 2239, E/SE  
2240 - 2258, E/SE  
TDWR  
2008 - 2009, 2014 - 2015, 2020 - 2021, 2130 - 2300  
intermittent between volume scans

**ASR-WSP data:** None

**Sounding Times:** 1203, 1350, 1646, 1944

**Aircraft data:** Westinghouse BAC1-11 on site for flight tests of forward looking radar with MB detection capability.

**ACARS data:** Yes

**Mesonet and LLWAS data:** 2121 - 2233

Station	1	93%	16	100%
	2	0%	17	99%
	3	88%	18	99%
	4	0%	19	100%
	5	0%	20	62%
	6	93%	21	100%
	7	92%	22	100%
	8	93%	23	100%
	9	0%	24	0%
	10	86%	25	100%
	11	0%	26	100%
	12	92%	27	100%
	13	0%	28	100%
	14	0%	29	100%
	15	0%	30	100%

**AWOS data:** Yes

**Interferometer data:** None

**Corona point data:** 2121 - 2233  
Stations C7, C3, C6, C1

# 25 AUGUST 91

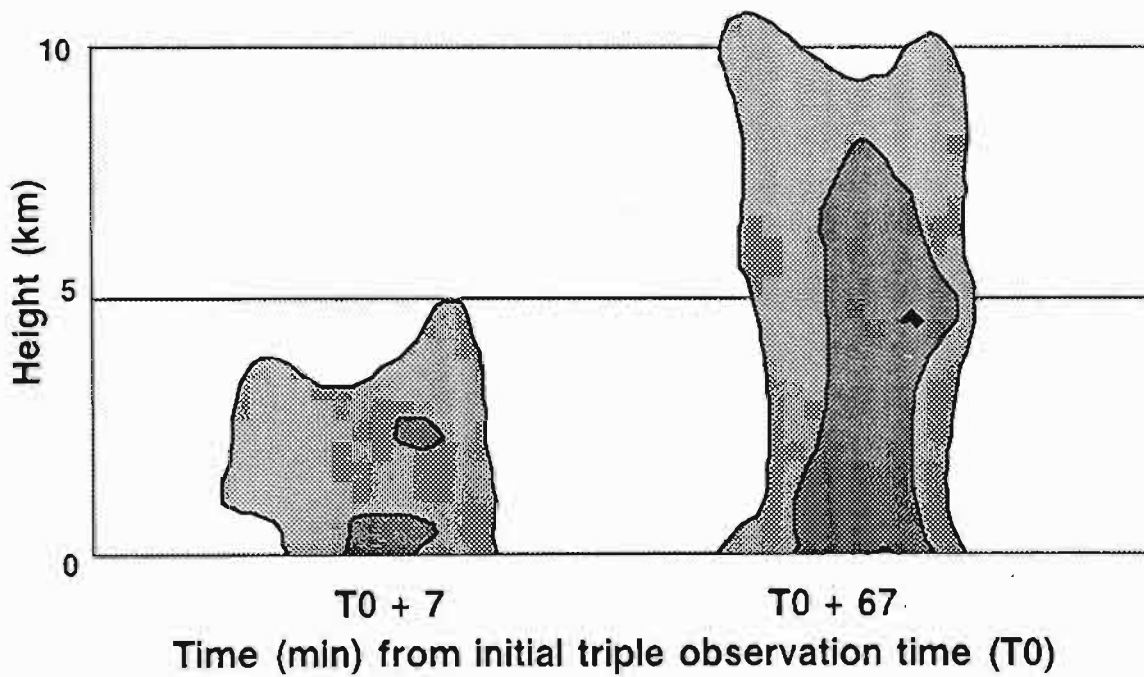
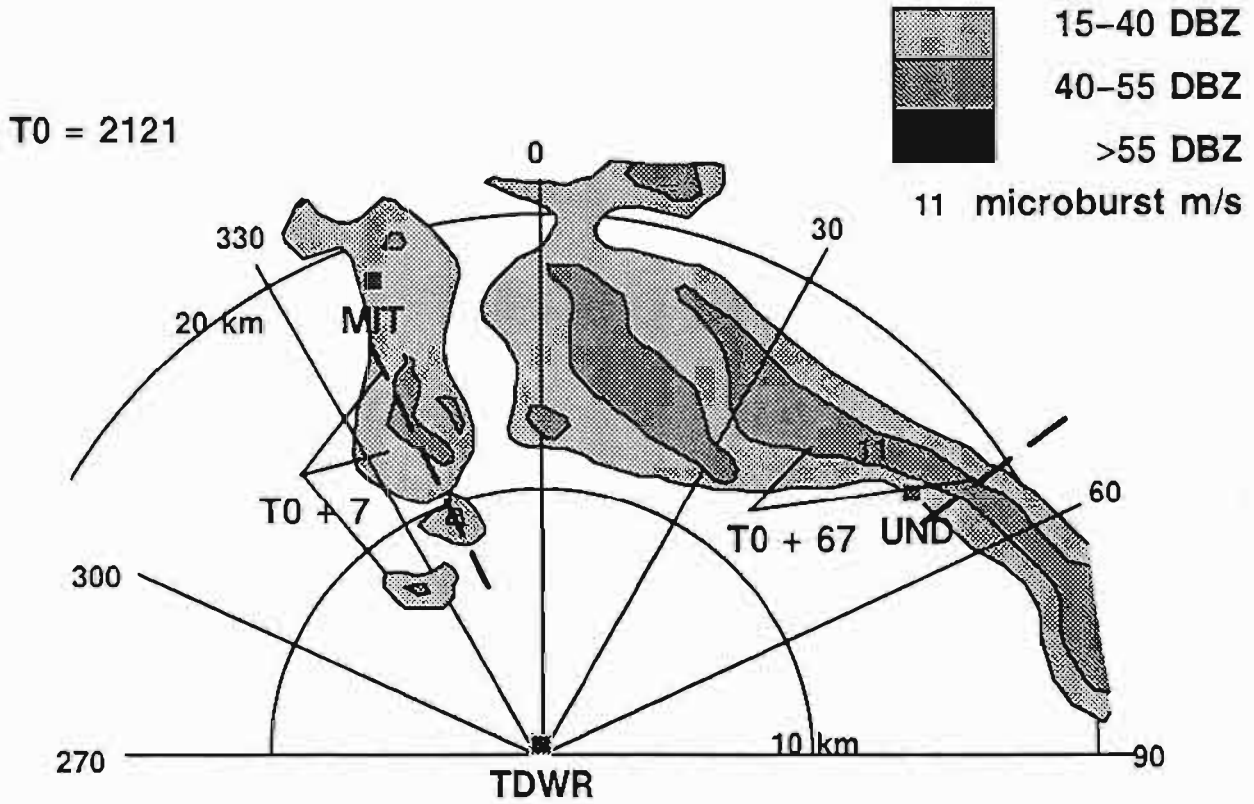

## 30 AUGUST 91

**Description:** Several air mass thunderstorms formed on this day, growing and dissipating quickly. Many small cells developed within the triple Doppler region, and moved westward as they dissipated. Four produced microbursts, with strengths ranging from 12 m/s to 16 m/s. The sounding taken at 1754 GMT showed light to moderate easterly winds from the surface to 8 km, where the winds increased and shifted from easterly to northerly. The freezing level was 4.8 km, the surface temperature was 29.3°C, the dew point was 19.4°C, and the lifted condensation level was 0.9 km.

The accompanying sketch shows the cells that formed at various times within the triple Doppler region. RHIs were taken through two of the cells, one at  $T_0 + 12$  min, and one at  $T_0 + 22$  min, which produced a 12 m/s outflow.

**Triple Doppler Times:** 1719 - 1820, MIT/UND/TDWR

**Total Coverage Times:** 1639 - 2221, TDWR  
1708 - 2139, UND  
1717 - 2221, MIT

**Site Observations:** MB (12 m/s) 1741 (07/020), MCO ✓†  
GF (7 m/s) 1803 (09/040), MCO  
MB (14 m/s) 1838 (12/050)  
MB (10 m/s) 1844 (08/345), MCO  
MB (10 m/s) 1857 (11/352), MCO  
MB (10 m/s) 1924 (14/359), MCO  
MB (10 m/s) 1936 (13/346)  
GF (4 m/s) 2101 (10/012), MCO

**Dual Doppler Times:** 1820 - 2139 UND/TDWR

**RHI Scans:** MIT  
1717 - 1718, 1822 - 1940, W  
TDWR  
1715 - 2200, intermittent between volume scans

**ASR-WSP data:** 1633 - 1639  
1711 - 1717  
1736 - 1748  
1750 - 1807  
1820 - 1826  
1922 - 1944

**Sounding Times:** 1217, 1454, 1754, 2027

**Aircraft data:** Westinghouse BAC1-11 on site for flight tests of forward looking radar with MB detection capability.

**ACARS data:** Yes

**Mesonet and LLWAS data:** 1719 - 1820

Station	1	93%	16	99%
	2	0%	17	99%
	3	93%	18	57%
	4	0%	19	99%
	5	0%	20	99%
	6	92%	21	99%
	7	93%	22	99%
	8	90%	23	99%
	9	0%	24	0%
	10	85%	25	100%
	11	0%	26	100%
	12	0%	27	100%
	13	0%	28	100%
	14	0%	29	100%
	15	0%	30	100%

**AWOS data:** Yes

**Interferometer data:** None

**Corona point data:** 1719 - 1820  
None

# 30 AUGUST 91

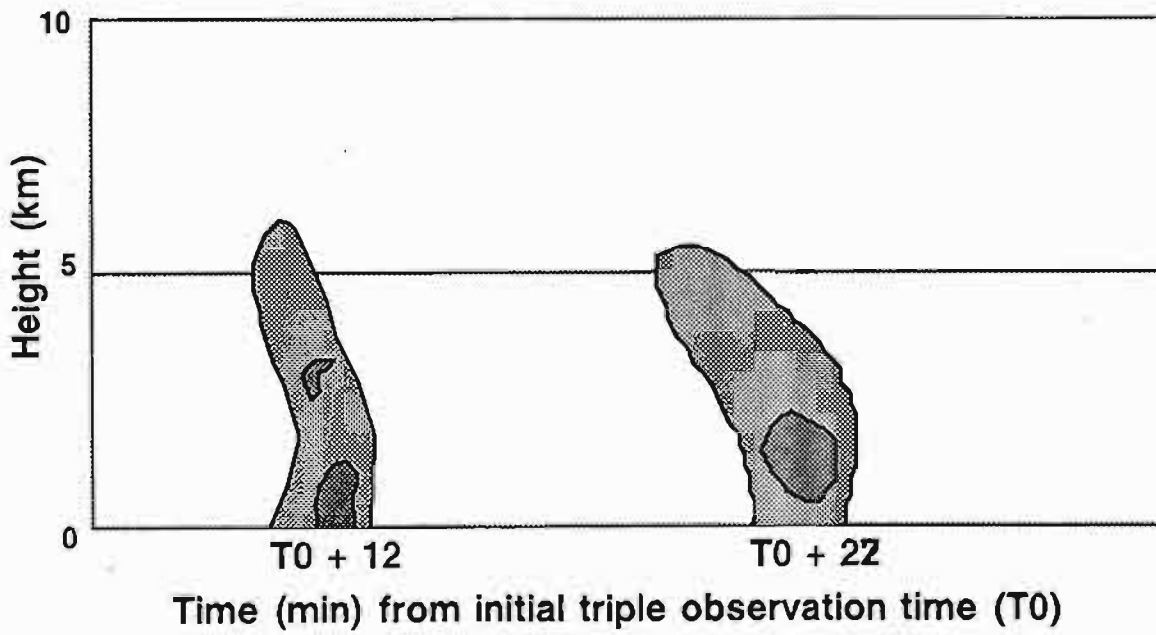
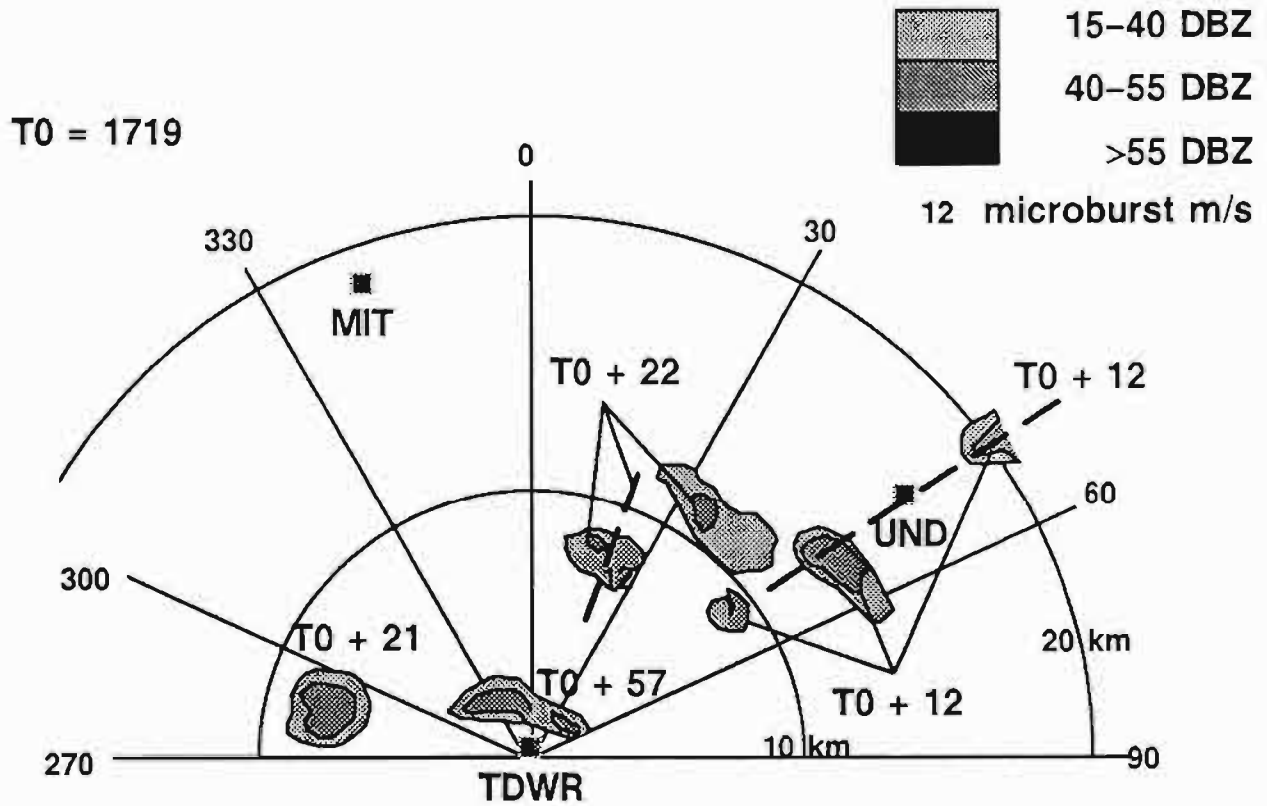

## 31 AUGUST 91

**Description:** A narrow line of thunderstorms moved southwestward across the triple Doppler region. As it moved, new development took place along the northwestern end of the line, while the cells at the southeastern end dissipated. Two microbursts were observed at the surface embedded in a long divergence line. By the time the line passed out of the triple sector, it had mostly dissipated. The sounding taken at 2053 GMT showed light easterly winds at the surface, light and variable winds up to the freezing level (5.6 km), and moderate to strong northwesterly winds above. The surface temperature was 26.7°C, the dew point was 19.8°C, and the lifted condensation level was 0.6 km.

The accompanying sketch shows the line as it moves toward the triple Doppler region at  $T_0 + 7$  min and the new development at the western end of the line at  $T_0 + 41$  min, the time of the maximum outflow strength of the 33 m/s microburst.

**Triple Doppler Times:** 2017 - 2134, MIT/UND/TDWR

**Total Coverage Times:** 1635 - 2203, TDWR  
1628 - 2138, UND  
1729 - 2205, MIT

**Site Observations:** GF (6 m/s) 1806 (07/356), MCO  
MB (24 m/s) 2032 (11/019), MCO ✓  
MB (12 m/s) 2032 (14/036)  
MB (25 m/s) 2049 (09/359), MCO ✓  
MB (14 m/s) 2055 (08/341) ✓  
MB (33 m/s) 2058 (10/327) ✓†

**Dual Doppler Times:** 1659 - 2017 UND/TDWR

**RHI Scans:** MIT  
1848 - 2016, NE/E/SE  
2141 - 2149, NW  
UND  
1726 - 1729, SE  
2008, N  
TDWR  
1934 - 2132, intermittent between volume scans

**ASR-WSP data:** 1930 - 2002  
2026 - 2046  
2047 - 2121



**Sounding Times:** 1215, 1450, 1745, 2053

**Aircraft data:** None

**ACARS data:** Yes

**Mesonet and LLWAS data:** 2017 - 2134

Station	1	0%	16	31%
	2	0%	17	39%
	3	0%	18	93%
	4	0%	19	94%
	5	0%	20	70%
	6	0%	21	93%
	7	0%	22	94%
	8	0%	23	94%
	9	0%	24	0%
	10	0%	25	100%
	11	0%	26	100%
	12	0%	27	100%
	13	0%	28	100%
	14	0%	29	100%
	15	0%	30	100%

**AWOS data:** Yes

**Interferometer data:** None

**Corona point data:** 2017 - 2134  
Stations C14, C25, C33

# 31 AUGUST 91

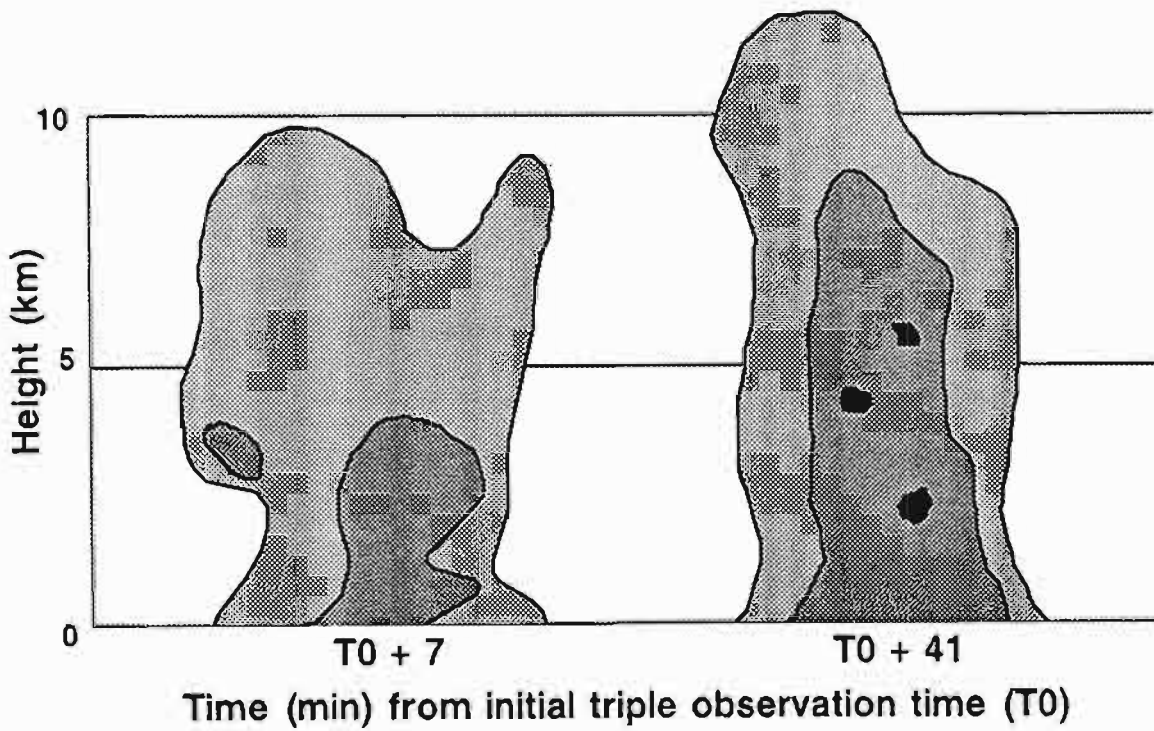
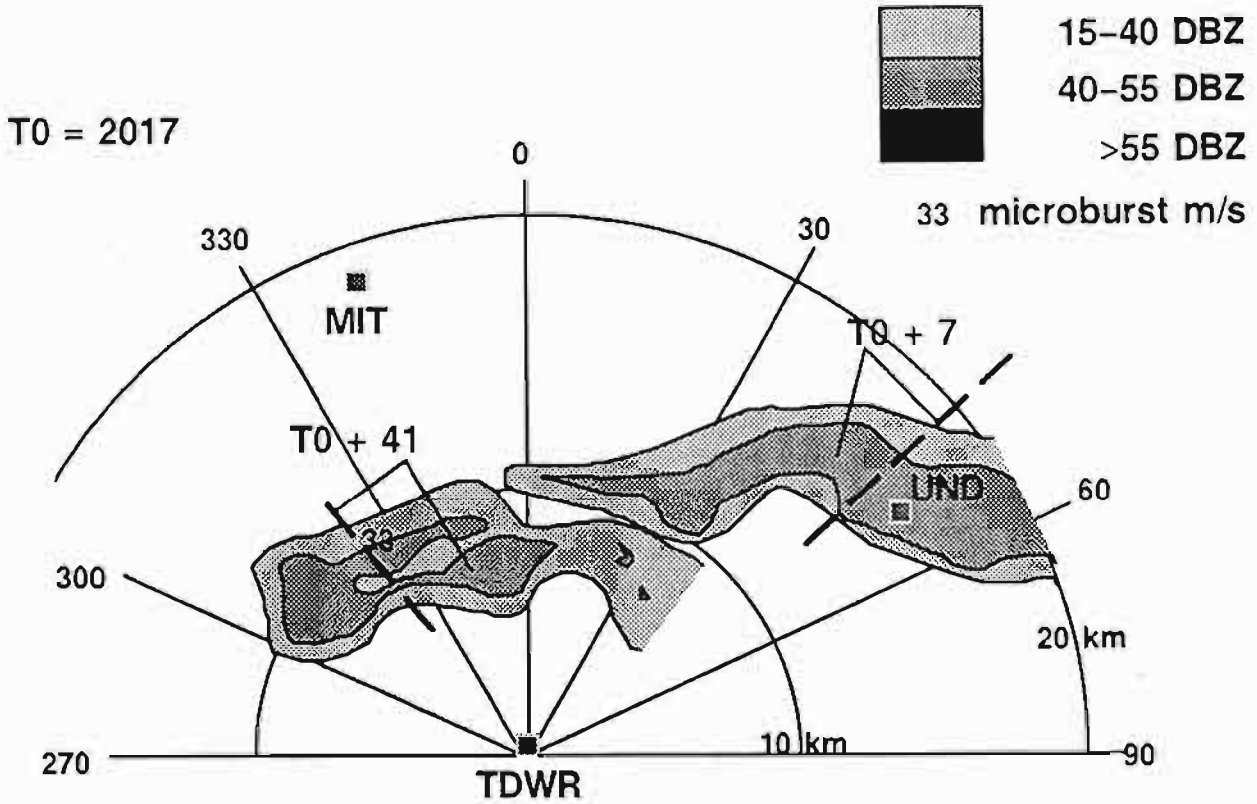

## 7 SEPTEMBER 91

**Description:** Many cells drifted into the triple Doppler region from the NE on this day. Most developed and dissipated quickly, without producing a microburst–strength outflow. Only two developed within the triple region, both forming in the same area and following the same path. Both produced microbursts, as did a cell that drifted into the northern part of the triple region. The sounding taken at 2050 GMT showed light northeasterly winds below the freezing level (4.9 km), and light north–northeasterly winds above. The surface temperature was 28.8°C, the dew point was 21.5°C and the lifted condensation level was 0.6 km.

The accompanying sketch shows the microburst–producing cells that passed through the triple Doppler region. The cell that drifted into the triple region and produced a microburst is shown at  $T_0 + 62$  min. The first cell to develop in the triple region is not shown, but its location at the time of maximum outflow strength,  $T_0 + 38$  min, is similar to that of the cell shown at  $T_0 + 77$  min. The second cell that developed in the triple region is shown at  $T_0 + 77$ , the time of maximum outflow.

**Triple Doppler Times:** 1930 – 1951, 2016 – 2112, MIT/UND/TDWR  
\*data gap (1951 – 2016) is due to faulty UND tape, SEP07B.

**Total Coverage Times:** 1929 – 2155 TDWR  
1925 – 1951, 2016 – 2112 UND  
1545 – 2306 MIT

**Site Observations:** MB (16 m/s) 1931 (10/230), MCO  
MB (11 m/s) 1940 (03/025), MCO  
MB (16 m/s) 2005 (09/353), MCO  
MB (12 m/s) 2017 (08/321), MCO  
MB (16 m/s) 2047 (09/337), MCO ✓†  
MB (14 m/s) 2047 (10/006), MCO ✓

**Dual Doppler Times:** 1951 – 2016, MIT/TDWR

**RHI Scans:** MIT  
1723 – 1807, NE/SW  
1918, SE  
2115, 2119 – 2130, S/SE  
2138 – 2142, NW  
2156 – 2202, 2251 – 2253, SE  
2301, S

**ASR–WSP data:** None

ASR-WSP data: None

Sounding Times: 1227, 1453, 1752, 2050

Aircraft data: None

ACARS data: Yes

Mesonet and LLWAS data: 1930 - 1951

Station	1	91%	16	99%
	2	90%	17	80%
	3	94%	18	99%
	4	0%	19	99%
	5	94%	20	97%
	6	0%	21	99%
	7	94%	22	99%
	8	94%	23	99%
	9	0%	24	0%
	10	93%	25	100%
	11	0%	26	100%
	12	93%	27	100%
	13	95%	28	100%
	14	0%	29	100%
	15	0%	30	100%

2016 - 2112

Station	1	93%	16	92%
	2	93%	17	47%
	3	93%	18	92%
	4	0%	19	92%
	5	92%	20	66%
	6	0%	21	91%
	7	94%	22	92%
	8	94%	23	92%
	9	0%	24	0%
	10	94%	25	100%
	11	0%	26	100%
	12	93%	27	100%
	13	93%	28	100%

14	0%	29	100%
15	0%	30	100%

**AWOS data:** Yes

**Interferometer data:** None

**Corona point data:** None

# 7 SEPTEMBER 91

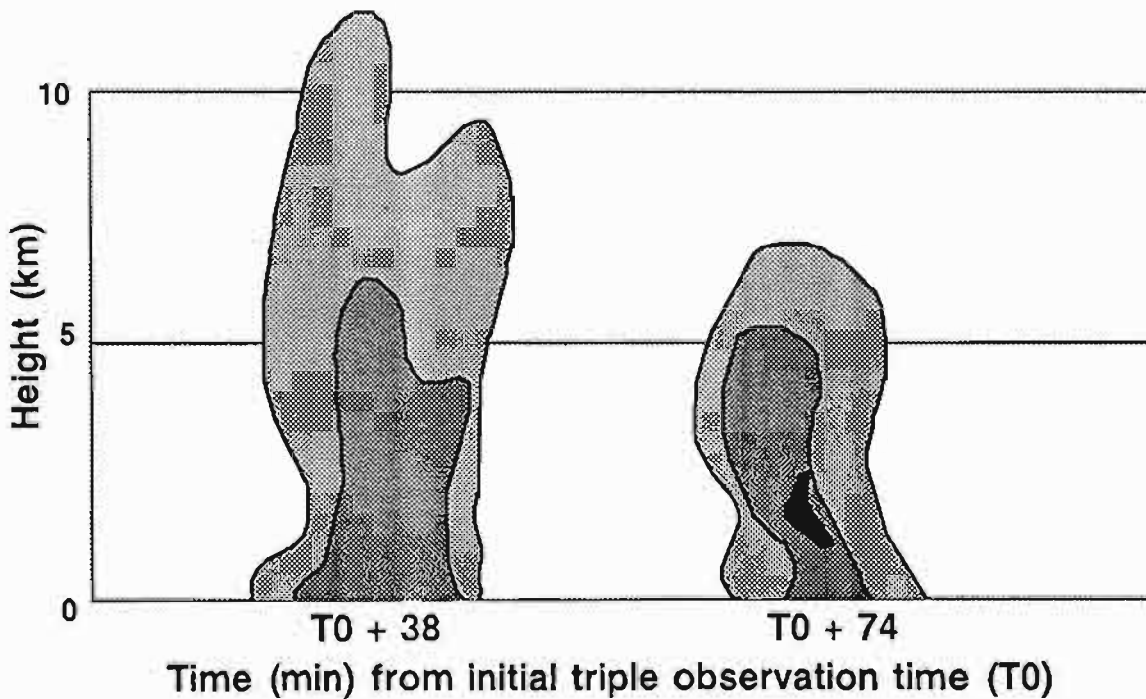
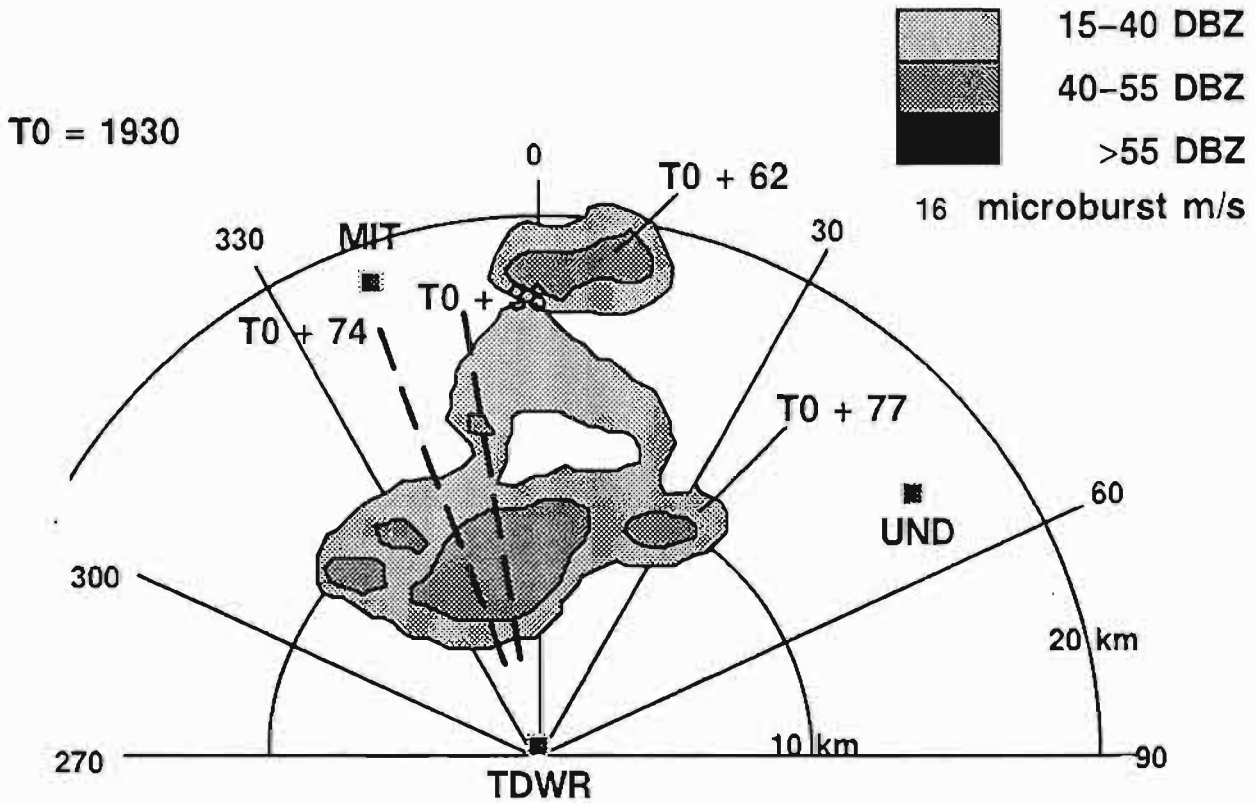

## 10 SEPTEMBER 91

**Decsription:** Some small cells formed quickly in the triple Doppler section, but also dissipated quickly while moving to the SW. One small cell formed early in the triple period, produced a weak microburst, and dissipated within 10 minutes. A second dissipating storm early in the triple period also produced a weak microburst near the TDWR testbed. The only other cell to produce a microburst in the triple region drifted in from the NE. It continued to developed after entering the triple region, and produced the microburst shortly before passing over the TDWR testbed. The sounding taken at 1747 GMT showed light to moderate northeasterly winds at the surface, light and variable winds to the freezing level (5.0 km), and light to moderate winds above. The surface temperature was 26.8°C, the dew point was 20.7°C, and the lifted condensation level was 0.5 km. The sounding taken at 1850 GMT showed similar conditions.

The accompanying sketch shows a cell that developed early in the triple period to the NW of the TDWR testbed at the time of its maximum outflow strength,  $T_0 + 15$  min. Another early cell is not shown, but an RHI of the cell is shown, at  $T_0 + 3$  min. The other cell to produce a microburst in the triple region is shown at  $T_0 + 69$  min, the time of maximum surface outflow strength.

**Triple Doppler Times:** 1710 - 1858, 1900 - 1912, MIT/UND/TDWR

**Total Coverage Times:** 1705 - 2016, TDWR  
1710 - 1952, UND  
1512 - 2152, MIT

**Site Observations:** MB (12 m/s) 1706 (03/020), MCO  
MB (10 m/s) 1806 (03/032), MCO  
MB (16 m/s) 1817 (02/351), MCO ✓†  
GF (7 m/s) 1824 (11/338), MCO  
MB (12 m/s) 1836 (13/344)

**Dual Doppler Times:** 1912 - 1952 UND/TDWR

**RHI Scans:** MIT  
1520 - 1708, E/SE  
1858 - 1900, S/SW  
1914 - 2142, 2152, SW  
UND  
1839, SW  
1842, W

**ASR-WSP data:** None

**Sounding Times:** 1220, 1502, 1747, 1850

**Aircraft data:** None

**ACARS data:** Yes

**Mesonet and LLWAS data:** 1710 – 1858

Station	1	92%	16	100%
	2	92%	17	91%
	3	92%	18	100%
	4	94%	19	100%
	5	0%	20	64%
	6	0%	21	99%
	7	92%	22	100%
	8	92%	23	100%
	9	0%	24	0%
	10	93%	25	100%
	11	0%	26	100%
	12	94%	27	100%
	13	0%	28	100%
	14	0%	29	100%
	15	0%	30	100%

1900 – 1912

Station	1	89%	16	100%
	2	95%	17	63%
	3	90%	18	96%
	4	89%	19	100%
	5	0%	20	14%
	6	0%	21	100%
	7	93%	22	100%
	8	90%	23	100%
	9	0%	24	0%
	10	92%	25	100%
	11	0%	26	100%
	12	90%	27	100%
	13	0%	28	100%
	14	0%	29	100%
	15	0%	30	100%

**AWOS data:** Yes



**Interferometer data:** None

**Corona point data:** None

# 10 SEPTEMBER 91

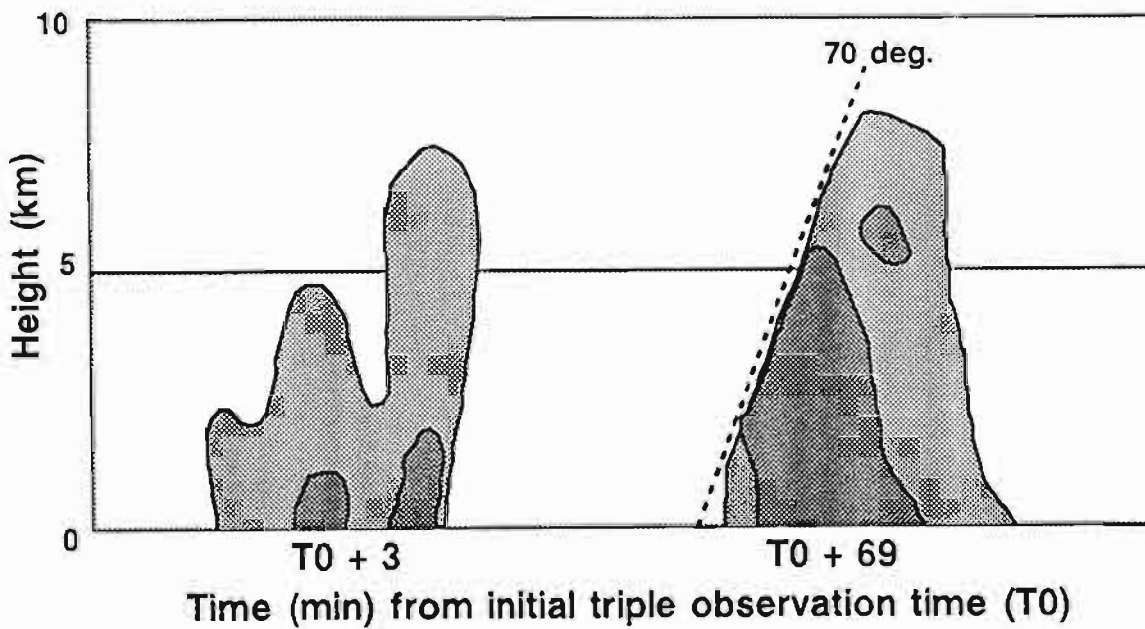
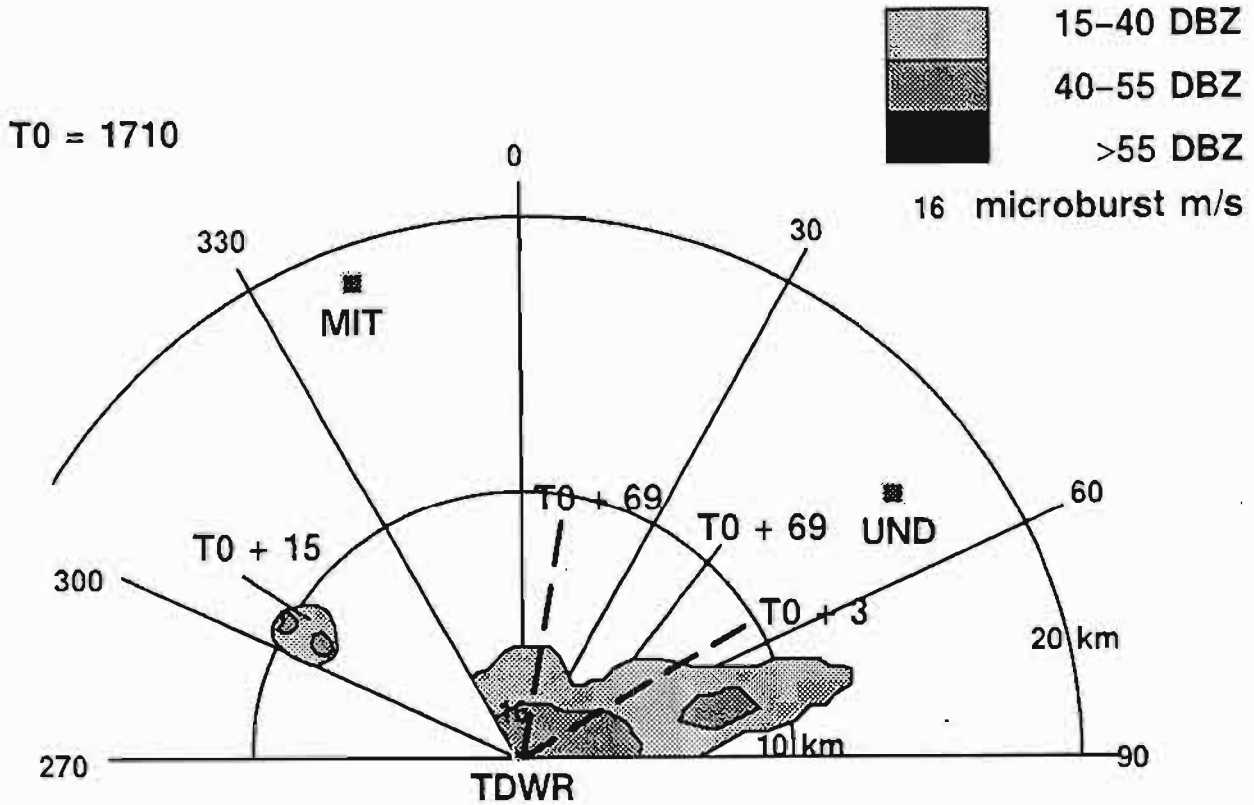

## 16 SEPTEMBER 91

**Description:** A cell rapidly developed in the triple Doppler region and proceeded to move to the SW over the TDWR testbed. A 14 m/s microburst was produced near the TDWR testbed as the cell passed by. As the cell moved outside the triple region, new development took place along the leading edge. The sounding taken at 1810 GMT showed light to moderate northeasterly surface winds and strong easterly winds throughout the rest of the layer. The surface temperature was 29.2°C, the dew point was 20.9°C, the freezing level was 5.4 km, and the lifted condensation level was 0.7 km.

The accompanying sketch shows the cell as it passed the TDWR testbed at  $T_0 + 26$  min, the time of maximum surface outflow.

**Triple Doppler Times:** 1730 – 1845, 1858 – 1927, MIT/UND/TDWR

**Total Coverage Times:** 1714 – 1944, TDWR  
1730 – 1927, UND  
1642 – 2136, MIT

**Site Observations:** MB (14 m/s) 1756 (03/029), MCO ✓†

**Dual Doppler Times:** no 1 – min dual outside of triple times

**RHI Scans:** MIT  
1701 – 1724, SE/ESE  
2013 – 2014, S

**ASR-WSP data:** 1800 – 1805

**Sounding Times:** 1213, 1508, 1810, 2044

**Aircraft data:** None

**ACARS data:** Yes

**Mesonet and LLWAS data:** Yes, but it has not been processed

**AWOS data:** Yes

**Interferometer data:** None

**Corona point data:** None

# 16 SEPTEMBER 91

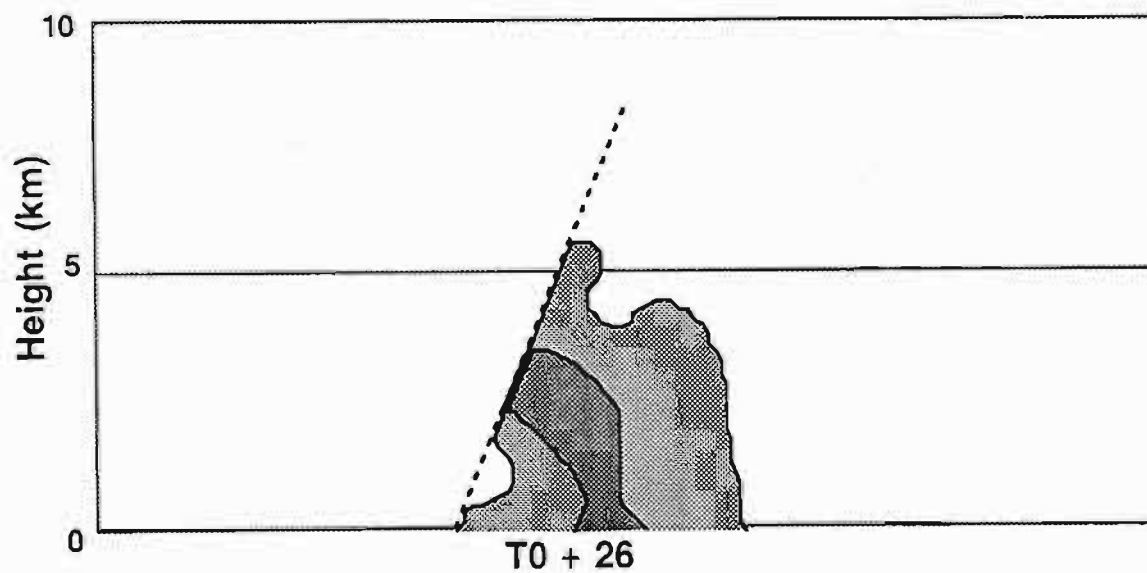
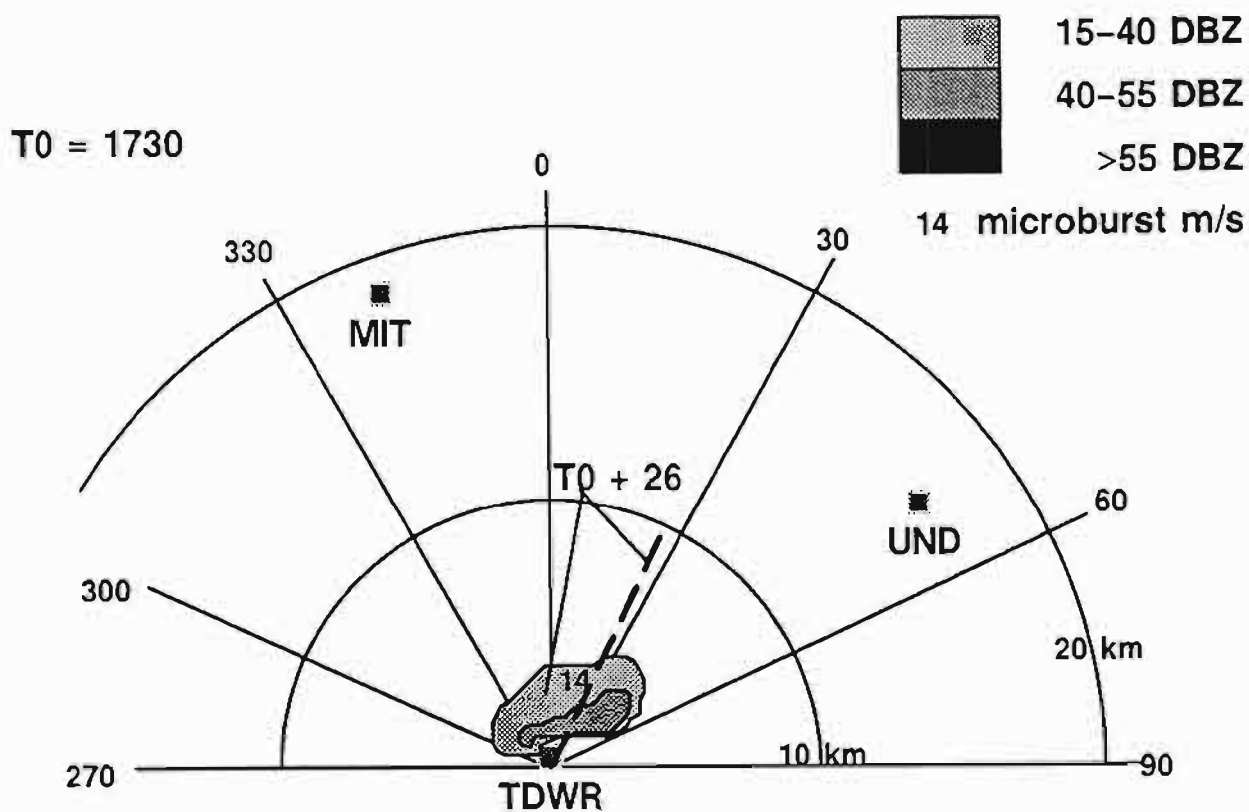

Time (min) from initial triple observation time (T0)

## 20 SEPTEMBER 91

**Description:** During the first triple period, a gust front passed through the triple Doppler region from N to S. A cell formed on the northern corner of the triple region behind the front, and moved southward and produced an 16 m/s microburst. A larger group of cells formed along the northeastern edge of the triple region, and stayed for the most part along that edge. One of the cells in this group produced a 14 m/s microburst along the edge of the triple region. The sounding taken at 1805 GMT taken during this triple period showed light and variable winds from the surface to 12 km. The surface temperature was 30.0°C, the dew point was 19.0°C, the freezing level was 4.7 km, and the lifted condensation level was 1.0 km.

The first accompanying sketch shows the cells that formed behind the gust front during the first triple period. The cell shown at  $T_0 + 24$  min produced an 18 m/s microburst, but the outflow was outside of the triple region. An RHI at the time of maximum outflow is shown. The second cell, shown at  $T_0 + 37$  min produced the 16 m/s outflow and an RHI of this cell is shown at the time of maximum outflow.

**Description:** During the second triple period a gust front passed through the triple region followed by a line of thunderstorms. The line moved into the triple region slowly, cells dissipating and growing along its length. The line eventually weakened as it approached the airport, and dissipated as it passed beyond. There was no sounding taken near this triple time.

There are two sketches for the second time period. The first shows the gust front that preceded the cells across the triple region. Both show the line of thunderstorms moving into the triple region, each at different stages. The RHIs show the vertical extent of this line at varying stages of its life cycle.

**Triple Doppler Times:** 1832 – 2000, 2301 – 0022 MIT/UND/TDWR

**Total Coverage Times:** 1717 – 0101, TDWR  
1800 – 0022, UND  
1555 – 1621, 1719 – 0106, MIT

**Site Observations:** GF (5 m/s) 1827 (11/353), MCO  
MB (14 m/s) 1906 (14/025) ✓  
MB (16 m/s) 1909 (13/028) ✓† (sketch 1)  
MB (23 m/s) 1916 (14/045)  
GF (5 m/s) 2056 (14/043)  
GF (8 m/s) 2253 (09/355), MCO † (sketch 2, shown in sketch at 2304)  
MB (12 m/s) 2336 (16/359)  
MB (16 m/s) 2340 (15/354), MCO ✓† (sketch 3)

MB (10 m/s) 2343 (13/010)  
MB (12 m/s) 2349 (12/357), MCO

**Dual Doppler Times:** 1800 – 1832, UND/TDWR  
2000 – 2301 UND/TDWR

**RHI Scans:** MIT  
1721 – 1812, NNW/NW  
1820 – 1831 SW/W  
2008 – 2014, S  
2017 – 2138, W/SW  
2150 – 2245, NNE/N/NNW/NW/W  
0034 – 0106, ENE/E/SE/S  
UND  
2023 – 2024, 2029 – 2045, NNE/NE  
2050 – 2108, E/ESE  
2112 – 2127, SE  
TDWR  
2053 E, 2107, E

**ASR-WSP data:** None

**Sounding Times:** 1215, 1516, 1805

**Aircraft data:** None

**ACARS data:** Yes

**Mesonet and LLWAS data:** Yes, but it has not been processed

**AWOS data:** Yes

**Interferometer data:** Yes; 1814 (9/20) – 2237 (9/21)

**Corona point data:** 1832 – 2000  
Stations C14, C25, C24, C32, C33, C28  
2301 – 0022  
Stations C14, C25, C24, C32, C33, C28, C39

# 20 SEPTEMBER 91

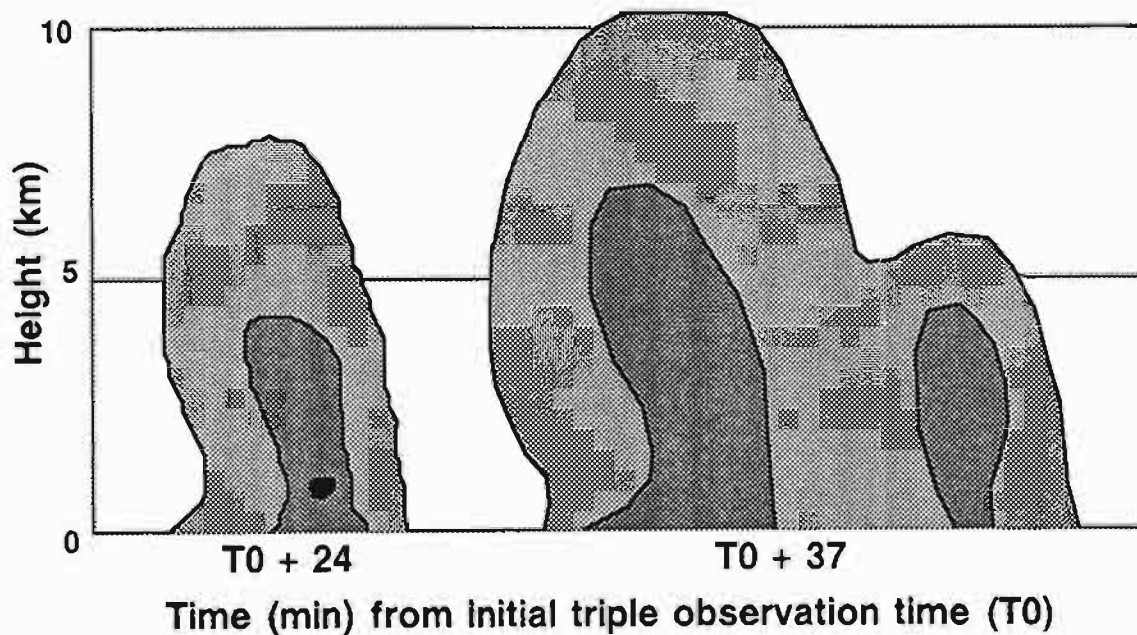
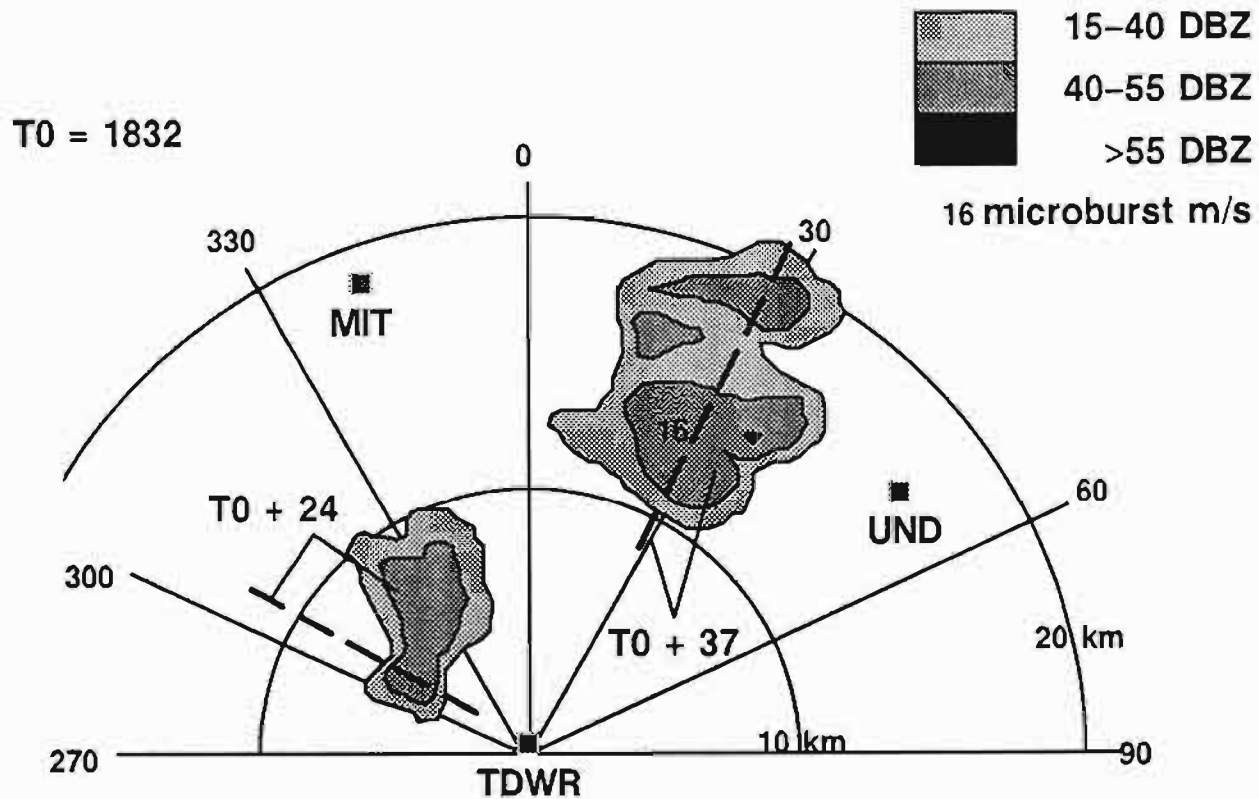

# 20 SEPTEMBER 91

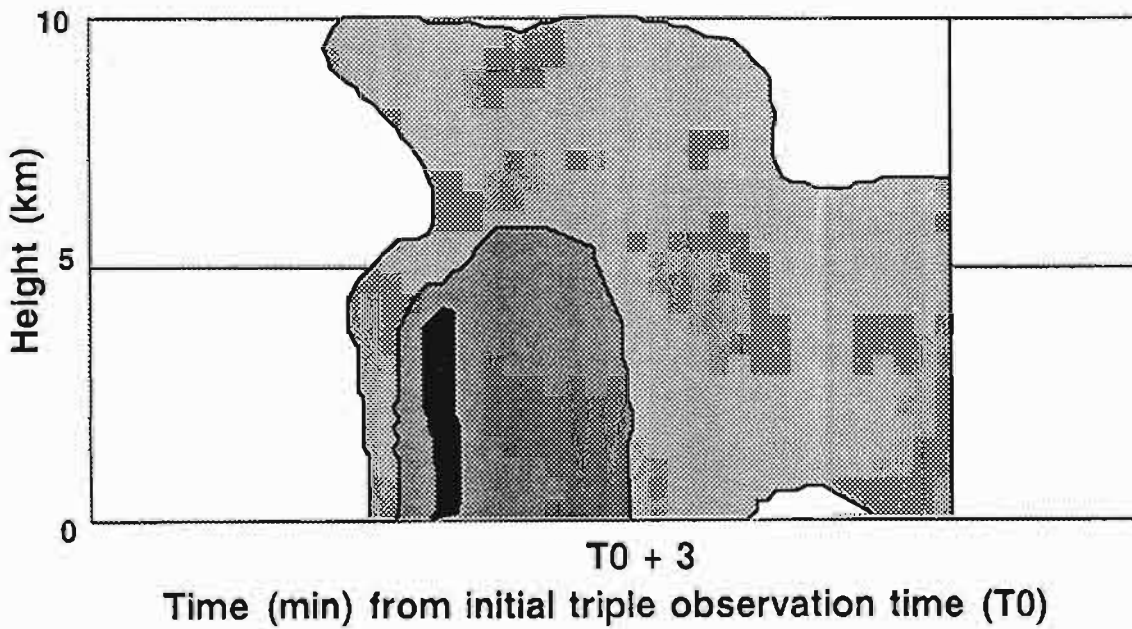
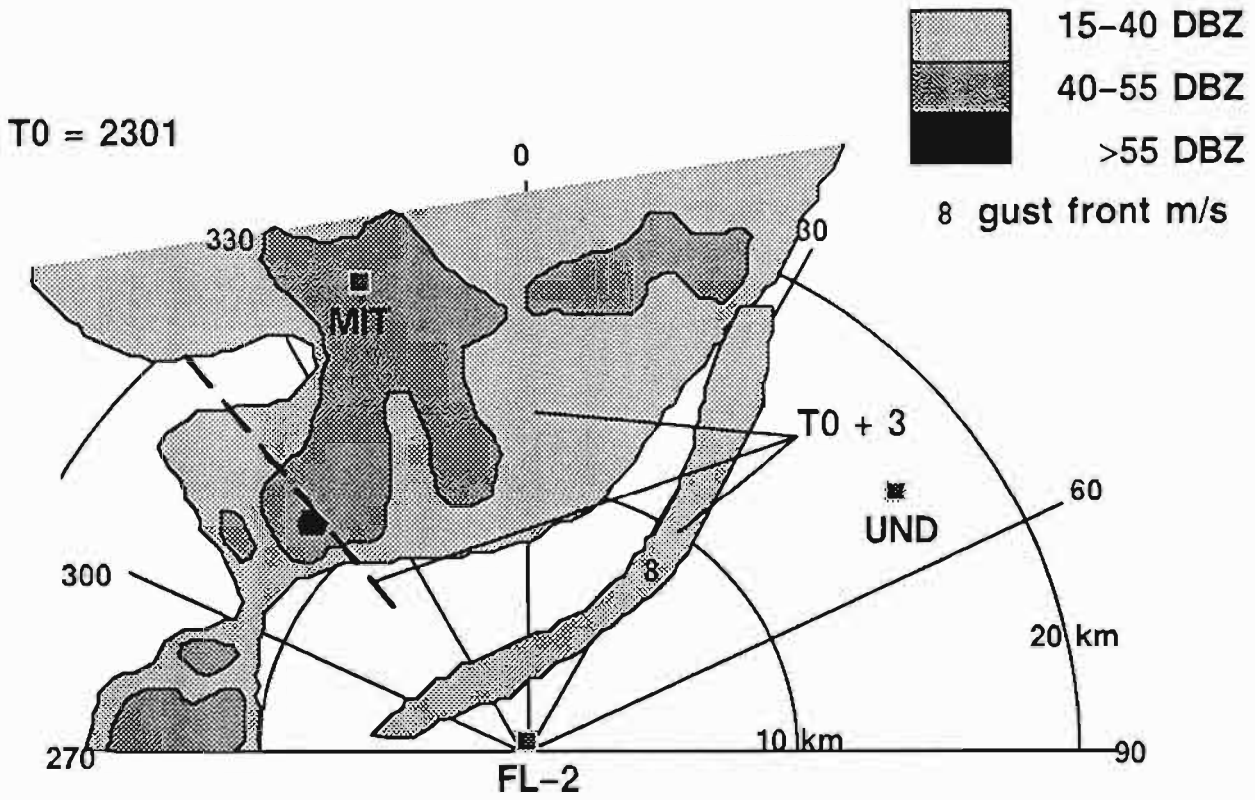



# 20 SEPTEMBER 91

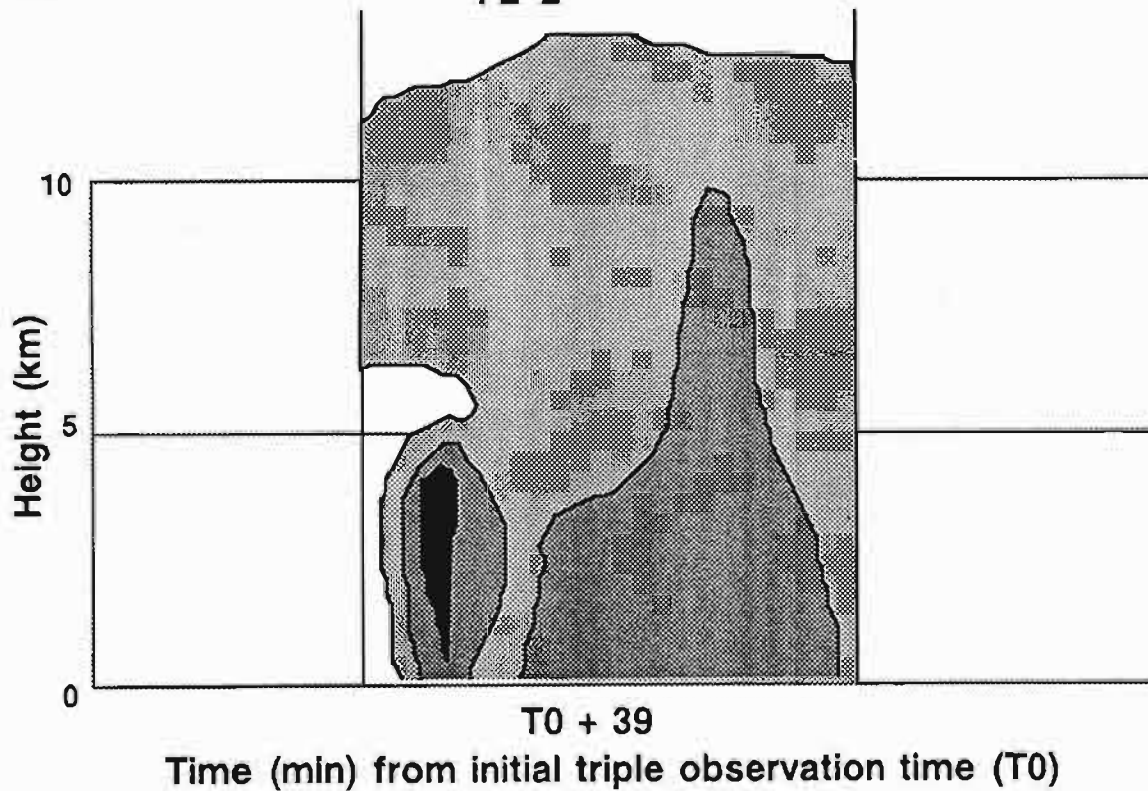
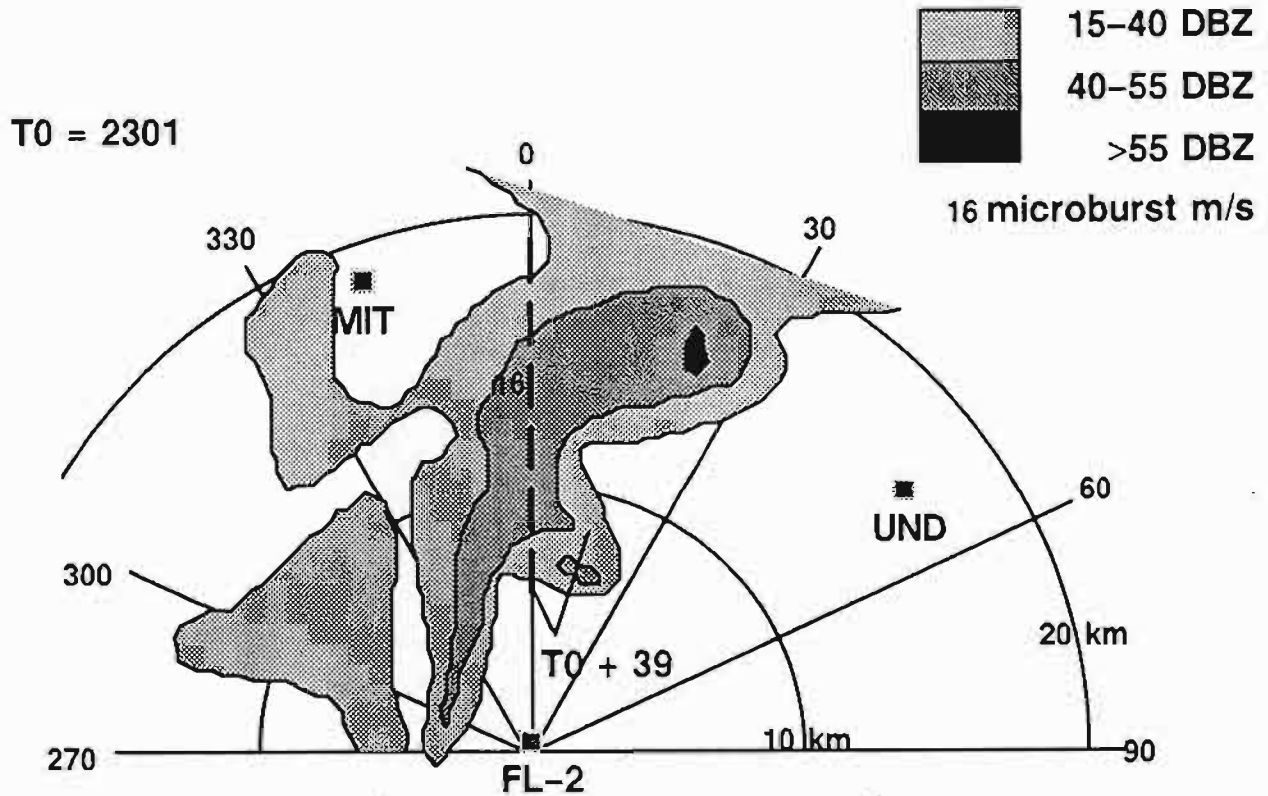

## 21 SEPTEMBER 91

**Description:** There was little activity within the triple Doppler region on this day. One small cell developed on the edge of the region, and moved southward past the UND radar. This cell produced a very weak microburst within the triple Doppler region before dissipating. The sounding taken at 1757 GMT showed light north-northeasterly winds below the freezing level (4.8 km), and light northwesterly winds above. The surface temperature was 29.0°C, the dew point was 20.7°C, and the lifted condensation level was 0.7 km.

The accompanying sketch shows the cell at the time of maximum outflow strength at  $T_0 + 4$  min. The RHI shows the structure of the cell just prior to the maximum outflow strength.

**Triple Doppler Times:** 1736 - 1823, 1833 - 1844 MIT/UND/TDWR

**Total Coverage Times:** 1659 - 2135, TDWR  
1725 - 2012, UND  
1736 - 1844, MIT

**Site Observations:** MB (10 m/s) 1740 (12/057) ✓†

**Dual Doppler Times:** 1725 - 1736, UND/TDWR  
1823 - 1833, UND/TDWR  
1844 - 2012 UND/TDWR

**RHI Scans:** MIT  
1824 - 1831, N  
2011 - 2025, SSW  
2106 - 2135, SSE/S/SSW/SW  
UND  
1928 - 1930, SSW

**ASR-WSP data:** None

**Sounding Times:** 1203, 1459, 1757, 2045

**Aircraft data:** None

**ACARS data:** Yes

**Mesonet and LLWAS data:** Yes, but it has not been processed

**AWOS data:** Yes

**Interferometer data:** Yes; 1814 (9/20) – 2237 (9/21)

**Corona point data:** None

# 21 SEPTEMBER 91

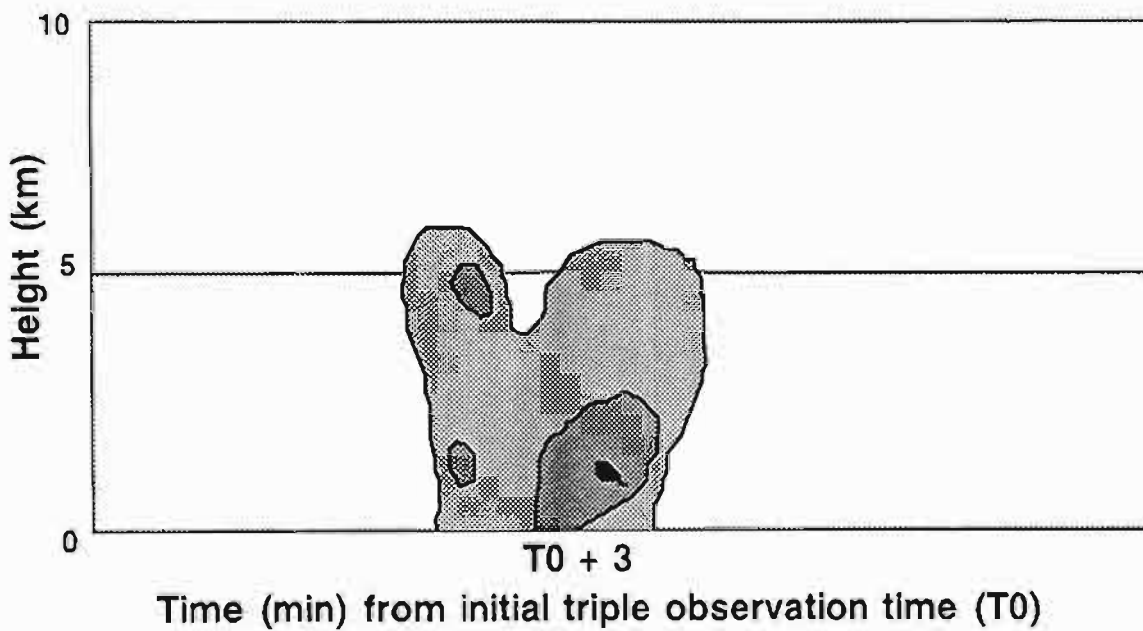
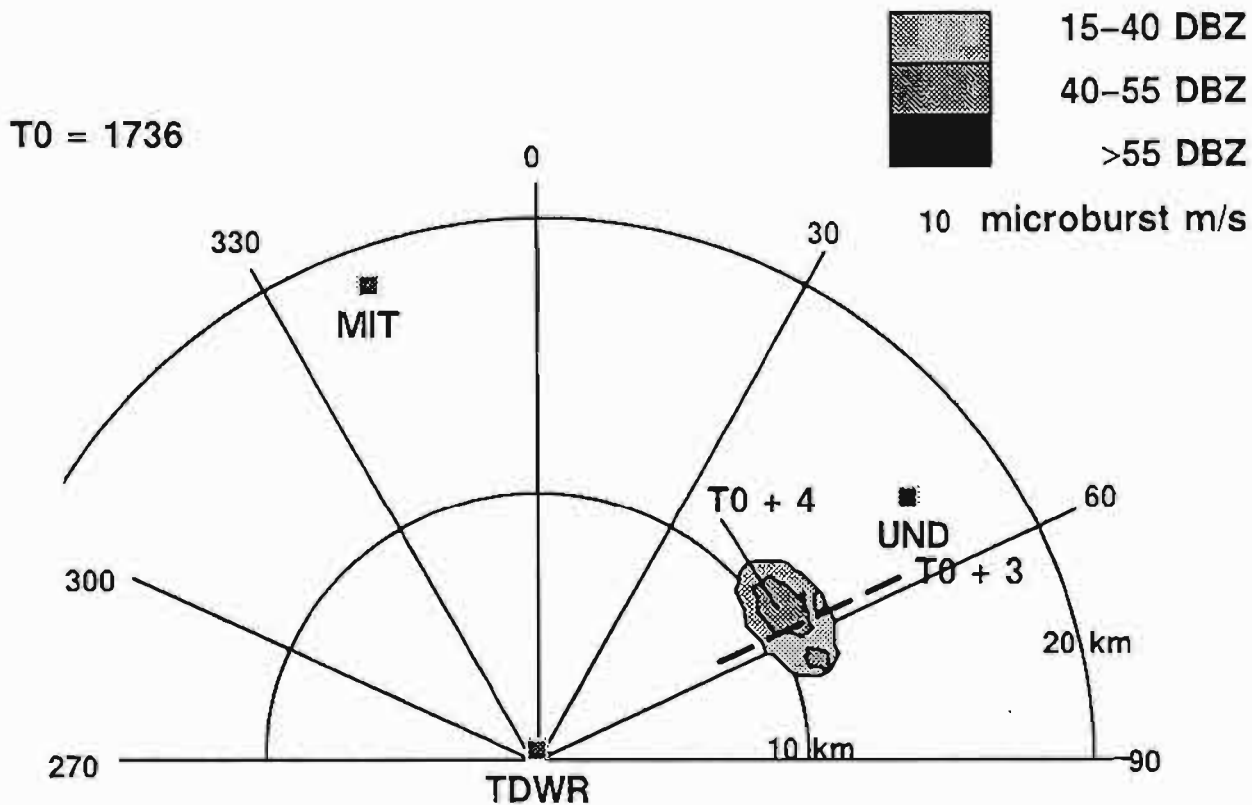

## 22 SEPTEMBER 91

**Description:** Numerous showers and thunderstorms moved rapidly from the NE to the SW across the triple Doppler region. One group of showers and thunderstorms produced a 12 m/s outflow while traversing the triple region. The sounding taken at 1451 GMT showed light to moderate east-northeasterly winds below the freezing level (4.9 km), and moderate northerly winds above. The surface temperature was 25.9°C, the dew point was 22.3°C, and the lifted condensation level was 0.3 km.

The accompanying sketch shows the group of showers and thunderstorms as it passes through the triple Doppler region and produces a microburst at  $T_0 + 11$  min. The RHI shows the vertical extent of the system.

**Triple Doppler Times:** 1705 – 1750 MIT/UND/TDWR

**Total Coverage Times:** 1440 – 2101, TDWR  
1647 – 1750, UND  
1525 – 2214, MIT

**Site Observations:** MB (12 m/s) 1716 (08/347) ✓†  
GF (6 m/s) 1719 (12/356)

**Dual Doppler Times:** None outside of triple times

**RHI Scans:** MIT  
1525 – 1530, E/SE  
1531 – 1533, NE  
1533 – 1540, SE  
1541 – 1616, NE  
1616 – 1617, NW  
1626 – 1628, S/W,  
1630 – 1703, NE/E/ESE  
1831 – 1918, N/NE  
1927 – 2018, NW/W  
2220 – 2227, N/E  
2027 – 2039, W  
2041 – 2214 N/NE

**ASR-WSP data:** None

**Sounding Times:** 1210, 1451

**Aircraft data:** None

**ACARS data:** Yes

**Mesonet data:** Yes, but it has not been processed

**AWOS data:** Yes

**Interferometer data:** Yes; 0400 - 2127

**Corona point data:** 1705 - 1750  
Stations C25, C32, C33

# 22 SEPTEMBER 91

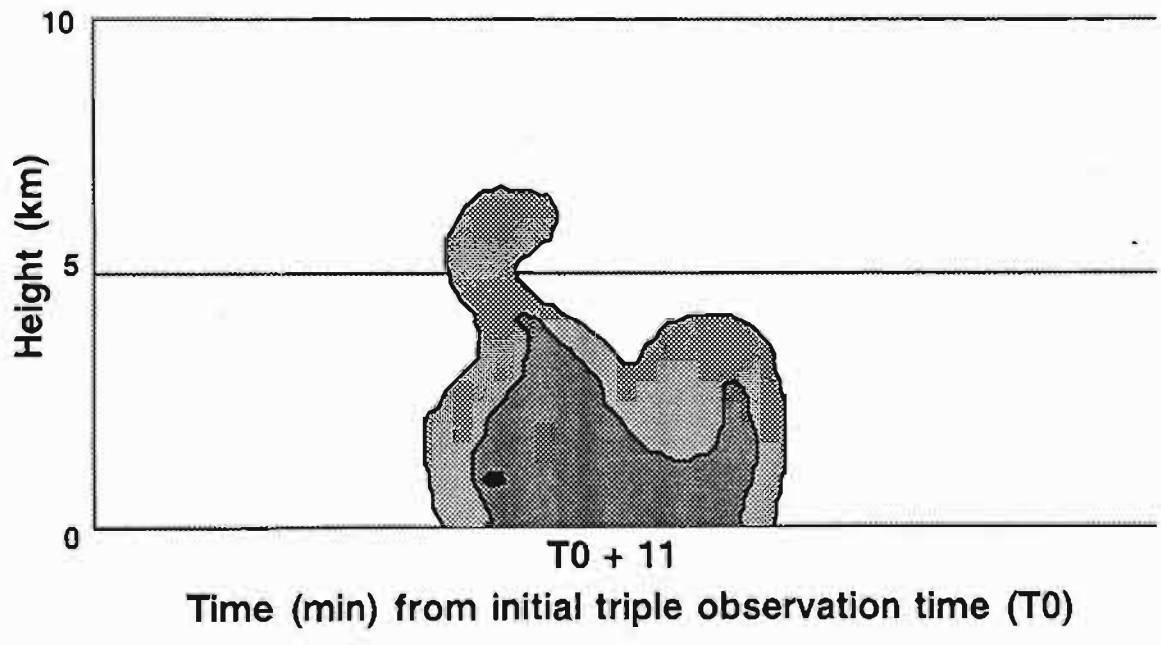
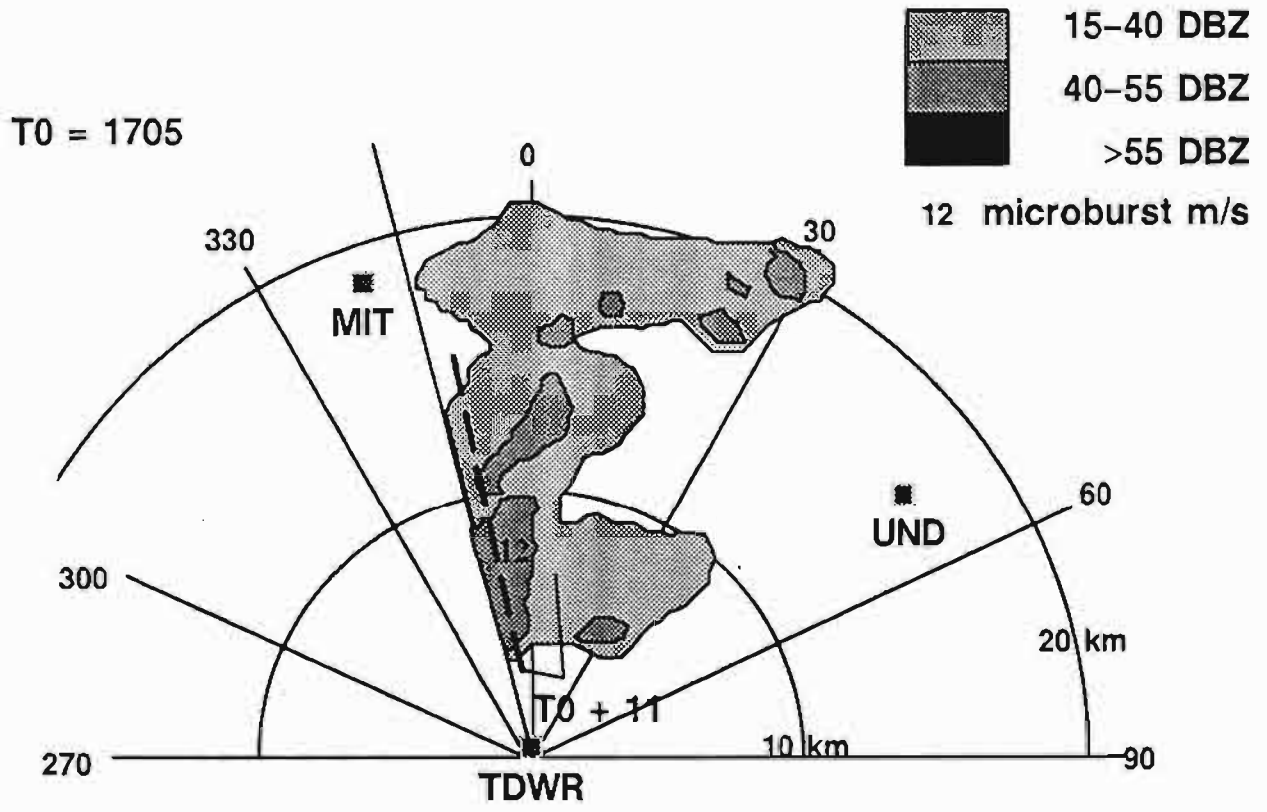

## 25 SEPTEMBER 91

**Description:** Many showers and thunderstorms moved in rapidly from the W, forming a loosely connected, disorganized line as it moved into the triple Doppler region. The line extended far to the N and to the S of the triple region. More development took place within the triple region, but it eventually dissipated, forming an extended region of stratiform precipitation. Thunderstorms embedded within the line produced three moderate microbursts, two beginning outside the triple Doppler region. The sounding taken at 1748 GMT showed moderate to strong southwesterly winds from the surface to 12 km. The surface temperature was 30.3°C, the dew point was 19.7°C, the freezing level was 4.8 km, and the lifted condensation level was 0.9 km. The sounding taken at 2020 GMT showed moderate to strong southwesterly winds from the surface to 12 km. The surface temperature was 25.8°C, the dew point was 19.6°C, the freezing level was 4.6 km, and the lifted condensation level was 0.5 km.

The accompanying sketch shows the line moving into the triple Doppler region from the west. The higher reflectivity regions drawn are part of the same line. Only the 40 dBZ contours are drawn, since the 15 dBZ contours would make the sketch confusing. The RHIs also have only the 40 dBZ contour for the same reason.

**Triple Doppler Times:** 1638 - 1844 MIT/UND/TDWR

**Total Coverage Times:** 1554 - 0041, TDWR  
1632 - 1844, UND  
1540 - 0111, MIT

**Site Observations:** GF (6 m/s) 1735, MCO  
MB (18 m/s) 1735 (6/315)  
MB (16 m/s) 1742 (13/344)  
MB (18 m/s) 1755 (6/326) ✓†

**Dual Doppler Times:** 1632 - 1638 UND/TDWR

**RHI Scans:** MIT  
1540 - 1636, W  
1848 - 1939, NE/S  
1941 - 2002, W/NW  
2006 - 2015, NE/E/ESE  
2206 - 2332, W/NW  
2337 - 2344, W  
2347, NNE  
2348 - 0111, W/NW/N



**ASR-WSP data:** 1229 - 1809

**Sounding Times:** 1210, 1504, 1748, 2020

**Aircraft data:** None

**ACARS data:** Yes

**Mesonet data:** Yes, but it has not been processed

**AWOS data:** Yes

**Interferometer data:** Yes; 0014 - 0000

**Corona point data:** None

# 25 SEPTEMBER 91

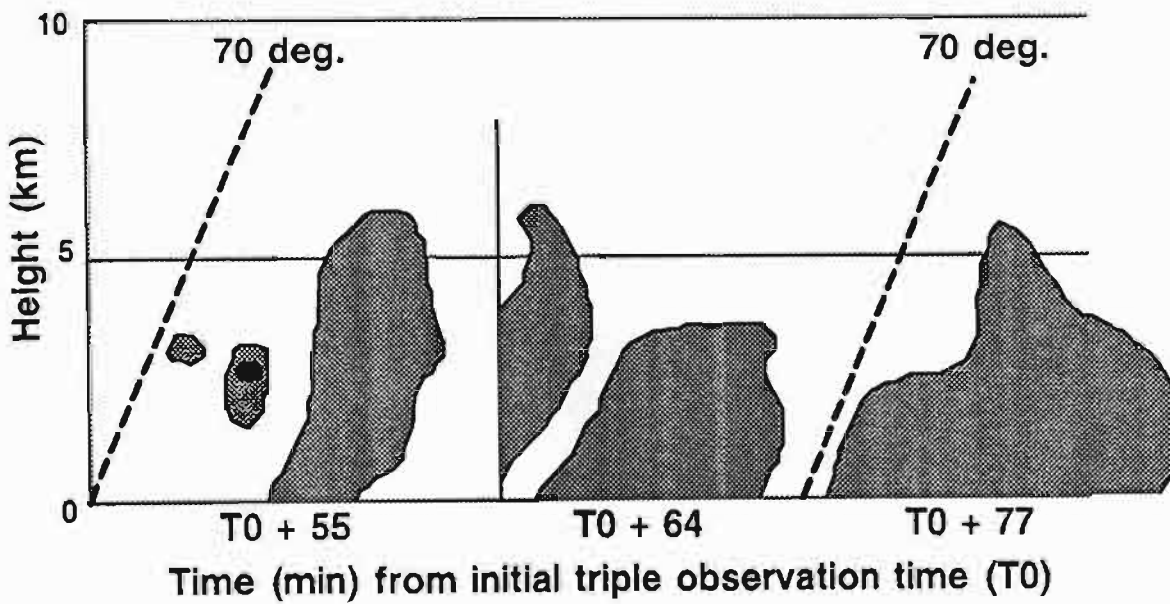
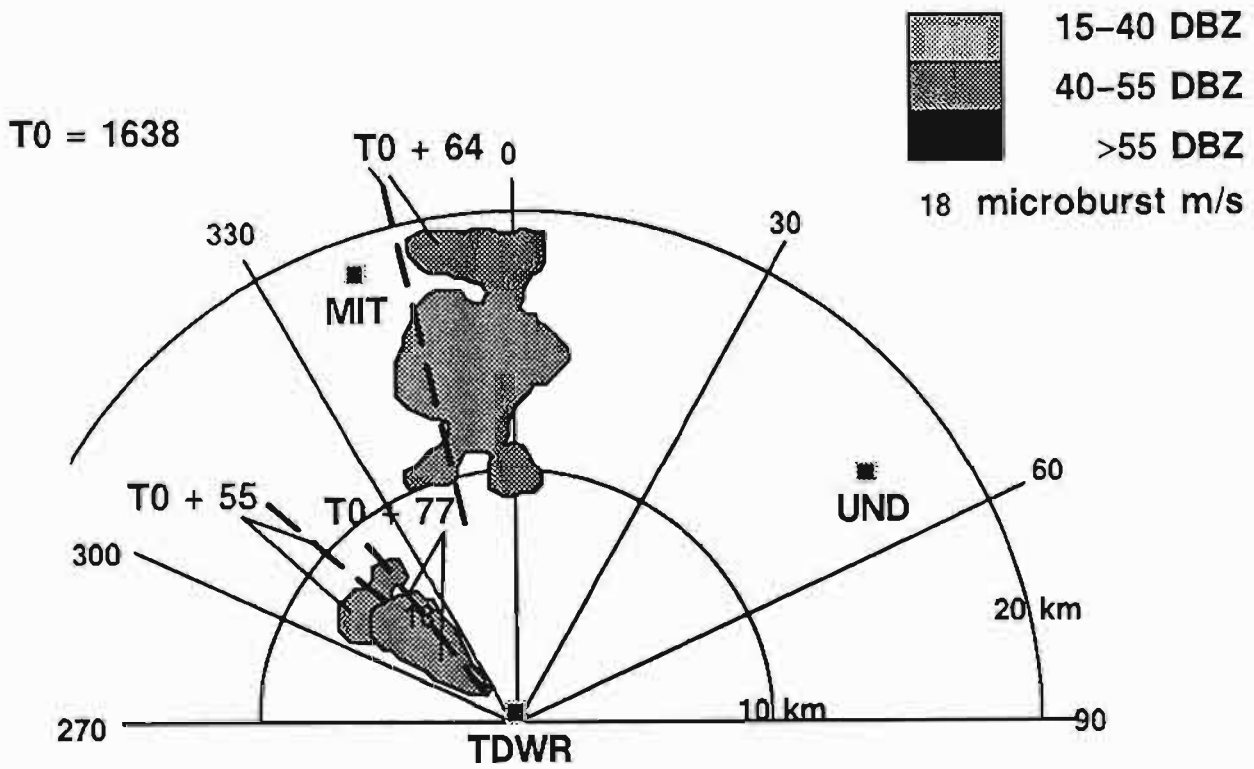

## 29 SEPTEMBER 91

**Description:** A large area of showers and thunderstorms oriented in a broad N-S line moved from E to W across the triple Doppler region. Most of the activity dissipated as it crossed the triple region, and new development took place on the northern edge of the area of precipitation. The entire line moved rapidly to the W, leaving the triple region clear. There was no sounding for this day.

The accompanying sketch shows the large area of showers and thunderstorms moving westward across the triple Doppler region. The area is shown at the time of maximum outflow of the only recorded microburst of the day in the triple region, at  $T_0 + 43$  min. An RHI through the cell that produced the outflow is shown at the same time. The area of precipitation is shown exiting the region at  $T_0 + 72$  min.

**Triple Doppler Times:** 1532 - 1651 MIT/UND/TDWR

**Total Coverage Times:** 1845 - 2112, TDWR  
1525 - 1730, UND  
1524 - 2038, MIT

**Site Observations:** GF (6 m/s) 1559 (06/074), MCO  
MB (12 m/s) 1615 (09/038), MCO ✓†

**Dual Doppler Times:** 1525 - 1532, UND/TDWR  
1651 - 1717 UND/TDWR

**RHI Scans:** MIT  
1524 - 1530, NE  
1703 - 1730 SW/W/NW  
1738 NE  
1738 - 1828 W/WNW  
1852 - 2038 SE/E  
TDWR  
2105 S  
2112 S

**ASR-WSP data:** None

**Sounding Times:** None

**Aircraft data:** None

**ACARS data:** Yes

**Mesonet and LLWAS data:** Yes, but it has not been processed

**AWOS data:** Yes

**Interferometer data:** Yes; 1038 (9/29) - 1024 (9/30)

**Corona point data:** 1532 - 1651  
Stations C25, C32, C33, C28

# 29 SEPTEMBER 91

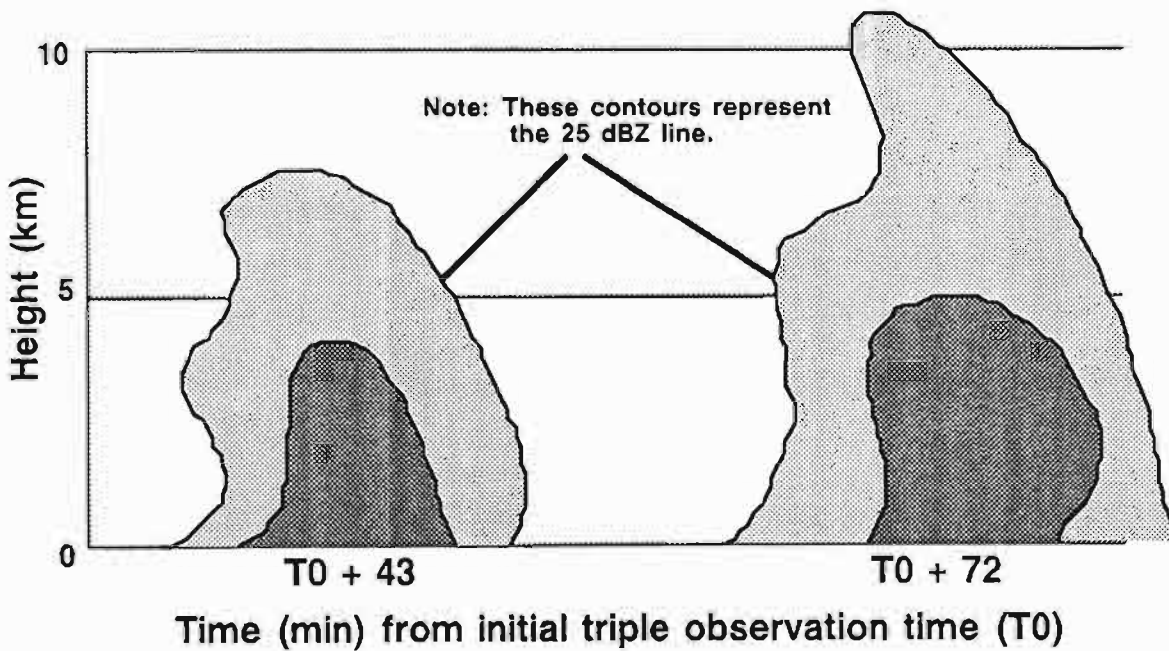
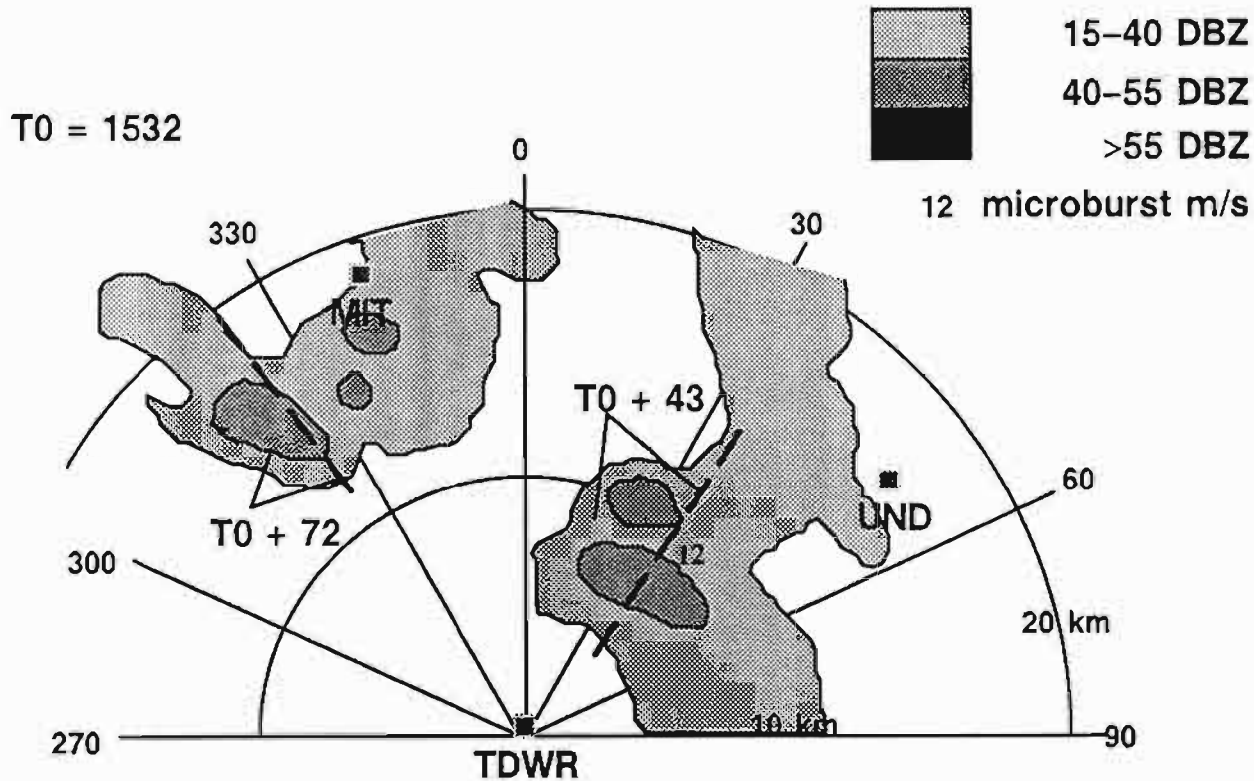

#### 4. SUMMARY

Statistics and detailed information on thunderstorms scanned with coordinated triple Doppler radars have been summarized in this report. The availability of radar and supporting sensor data has been detailed for each triple Doppler case. All of the data described herein are available through Lincoln Laboratory, under sponsorship of the Federal Aviation Administration. Written requests for specific data may be directed to:

Dr. Marilyn M. Wolfson  
MIT Lincoln Laboratory  
P.O. Box 73  
Lexington, MA 02173.

**APPENDIX A**  
**CORONA POINT STATION – SENSOR ASSOCIATION**

Since different corona point sensors could be physically located on the same corona point station (*e.g.*, when a malfunctioning sensor had to be replaced), Table A-1 lists each corona point station, its associated sensors, and the dates of the associations. One corona point sensor may be associated with several corona point stations over the course of the summer.

## LIST OF ABBREVIATIONS

ACARS	Aircraft Communications Addressing and Reporting Service
AGL	Above Ground Level
ARINC	Aeronautical Radio, Incorporated
ASR	Airport Surveillance Radar
ATC	Air Traffic Control
AWOS	Automated Weather Observing System
CaPE	Convective and Precipitation/Electrification Experiment
FAA	Federal Aviation Administration
FSL	Forecast Systems Laboratory
GF	Gust Front
GMT	Greenwich Mean Time
INS	Inertial Navigation System
ITWS	Integrated Terminal Weather System
LLWAS	Low Level Wind Shear Alert System
LORAN	Long Range Navigation system
MB	Microburst
MCO	Orlando International Airport
MIT	Massachusetts Institute of Technology
NASA	National Aeronautics and Space Administration
NCAR	National Center for Atmospheric Science
NOAA	National Oceanic and Atmospheric Administration
ONERA	Office National d'Etudes et de Recherches Aeronautiques
RHI	Range-Height Indicator
SAFIR	Systeme d'Alerte Foudre par Interferometrie Radioelectrique
TASS	Terminal Area Surveillance System
TDWR	Terminal Doppler Weather Radar
UND	University of North Dakota
VHF	Very High Frequency
WSP	Wind Shear Processor



## REFERENCES

1. Bernella, D.M., 1991: Terminal Doppler Weather Radar operational test and evaluation Orlando 1990. *Project Report ATC-179*, MIT/Lincoln Laboratory, FAA Report No. DOT/FAA/NR-91/2, 114 pp.
2. Noyes, T.A., S.W. Troxel, M.E. Weber, O.J. Newell, and J.A. Cullen, 1991: The 1990 Airport Surveillance Radar Wind Shear Processor (ASR-WSP) operational test at Orlando International Airport. *Project Report ATC-178*, MIT/Lincoln Laboratory, FAA Report No. DOT/FAA/NR-91/1, 63 pp.
3. Ray, P.S., C.L. Ziegler, W. C. Bumgarner, and R. J. Serafin, 1980: Single- and multiple-Doppler radar observations of tornadic storms. *Mon. Wea. Rev.*, **108**, 1607-1625.
4. Ray, P.S. and K. L. Sangren, 1983: Multiple-Doppler radar network design. *J. Climate Appl. Meteor.*, **22**, 1444-1454.
5. DeLaura, R., M.M. Wolfson, and P.S. Ray, 1991: A hybrid Cartesian windfield synthesis technique using a triple Doppler radar network. *Preprints, 25th International Conference on Radar Meteorology*, Paris, Amer. Meteor. Soc., 630-633.
6. Weber, M. and T.A. Noyes, 1988: Low-altitude wind shear detection with Airport Surveillance Radars: Evaluation of 1987 field measurements. *Project Report ATC-159*, MIT/Lincoln Laboratory, FAA Report No. DOT/FAA/PS-88/10, 120 pp.
7. Weber, M.E., 1989: Dual-beam autocorrelation based wind estimates from Airport Surveillance Radar signals. *Project Report ATC-167*, MIT/Lincoln Laboratory, FAA Report No. DOT/FAA/PS-89/5, 60 pp.
8. Laroche, P., C. Malherbe, A. Bondiou, M. Weber, C. Engholm, and V. Coel, 1991: Lightning activity in microburst producing storm cells. *Preprints, 25th International Conference on Radar Meteorology*, Paris, Amer. Meteor. Soc., J85-J88.