

**Project Report
ATC-234**

**Integrated Terminal Weather System (ITWS)
Demonstration and Validation
Operational Test and Evaluation**

**D. L. Klinge-Wilson
Editor**

13 April 1995

Lincoln Laboratory
MASSACHUSETTS INSTITUTE OF TECHNOLOGY
LExINGTON, MASSACHUSETTS

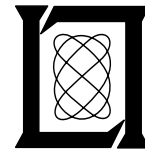

Prepared for the Federal Aviation Administration,
Washington, D.C. 20591

This document is available to the public through
the National Technical Information Service,
Springfield, VA 22161

This document is disseminated under the sponsorship of the Department of Transportation in the interest of information exchange. The United States Government assumes no liability for its contents or use thereof.

1. Report No. ATC-234	2. Government Accession No.	3. Recipient's Catalog No.	
4. Title and Subtitle Integrated Terminal Weather System (ITWS) Demonstration and Validation Operational Test and Evaluation		5. Report Date 13 April 1995	
		6. Performing Organization Code	
7. Author(s) Diana L. Klingle-Wilson		8. Performing Organization Report No. ATC-234	
9. Performing Organization Name and Address Lincoln Laboratory, MIT P.O. Box 9108 Lexington, MA 02173-9108		10. Work Unit No. (TRAIS)	
		11. Contract or Grant No. DTFA01-91-Z-02036	
12. Sponsoring Agency Name and Address Department of Transportation Federal Aviation Administration Systems Research and Development Service Washington, DC 20591		13. Type of Report and Period Covered	
		14. Sponsoring Agency Code	
15. Supplementary Notes This report is based on studies performed at Lincoln Laboratory, a center for research operated by Massachusetts Institute of Technology under Air Force Contract F19628-95-C-0002.			
16. Abstract During summer 1994, MIT Lincoln Laboratory conducted the Operational Test and Evaluation Demonstration and Validation (Dem Val) of the Federal Aviation Administration's Integrated Terminal Weather System (ITWS). The purpose of the demonstration was to obtain user feedback on products and to prove that the ITWS products and concept were sufficiently mature to proceed with procurement. Dem Val was conducted at the Memphis International Airport from 23 May through 22 July and at the Orlando International Airport from 11 July through 19 August. Products were delivered to users at the Memphis Airport Traffic Control Tower (ATCT) and TRACON (Terminal Radar Approach Control), at the Memphis Air Route Traffic Control Center (ARTCC), at the Orlando International ATCT and TRACON, and at the Jacksonville ARTCC. In addition, ITWS displays were available to the National Weather Service forecast offices at Memphis, TN, and Melbourne, FL; to Northwest Airlines in Minneapolis, MN; and to Delta Airlines in Orlando, FL. This report documents the technical performance of the product generation algorithms. Each algorithm is described briefly, including the product operational and display concepts. The techniques by which the technical performance is assessed and the results of the assessment are presented. The performance of the algorithms is measured against the Minimum Operational Performance Requirements (MOPR), which products must meet to be considered operationally useful by the ATC user community. Not all products have an MOPR. Those products that are assigned MOPR are microburst prediction, gust front forecast, storm motion, storm extrapolated position, storm cell information, ITWS precipitation, and terminal winds. Of those products, all met or exceeded the requirements.			
17. Key Words ITWS evaluation demonstration Memphis validation Orlando operational test algorithm		18. Distribution Statement This document is available to the public through the National Technical Information Service, Springfield, VA 22161.	
19. Security Classif. (of this report) Unclassified	20. Security Classif. (of this page) Unclassified	21. No. of Pages 112	22. Price

TABLE OF CONTENTS

Abstract	i
List of Illustrations	v
List of Tables	vii
1. INTRODUCTION	1
1.1 1994 Demonstration and Validation	1
1.2 DemVal at Memphis International Airport	6
1.3 DemVal at Orlando International Airport	6
1.4 Organization of the Report	6
2. ITWS PRECIPITATION AND ASR-9 PRECIPITATION PRODUCTS	9
2.1 Removing AP Clutter for ASR-9 Data	9
2.2 Technical Performance Assessment and Results	19
3. ITWS STORM CELL INFORMATION PRODUCT	23
3.1 Storm Cell Information Algorithm	23
3.2 Technical Performance Assessment and Results	23
4. ITWS STORM MOTION AND STORM EXTRAPOLATED POSITION PRODUCTS	31
4.1 Storm Motion/Storm Extrapolated Position Algorithms	31
4.2 Technical Performance Assessment and Results	39
5. ITWS MICROBURST PRODUCTS	45
5.1 Microburst Detection Algorithm	45
5.2 Technical Performance Assessment and Results	49
5.3 Microburst Prediction Algorithm	51
5.4 Technical Performance Assessment and Results	51
6. ITWS GUST FRONT AND WIND SHIFT PRODUCTS	55
6.1 Gust Front Algorithm	55
6.2 Technical Performance Assessment and Results	55
7. ITWS TERMINAL WINDS PRODUCT	69
7.1 Terminal Winds Estimation Algorithm	69
7.2 Technical Performance Assessment and Results	75
8. ITWS AIRPORT LIGHTNING PRODUCT	77
8.1 Lightning Warning Panel Algorithm	77
8.2 Technical Performance Assessment and Results	77

TABLE OF CONTENTS (Continued)

9.	TERMINAL WEATHER TEXT MESSAGE PRODUCT	83
9.1	Product Generation	83
9.2	Technical Performance Assessment and Results	87
10.	CONCLUSIONS	91
	BIBLIOGRAPHY	93
	APPENDIX A. LIST OF ACRONYMS AND ABBREVIATIONS	95
	APPENDIX B. DAY-BY-DAY MICROBURST PREDICTION STATISTICS	99
	APPENDIX C. MEMPHIS GUST FRONT WIND SHIFT AND WIND SHEAR DATA USED FOR PERFORMANCE EVALUATION	103

LIST OF ILLUSTRATIONS

Figure No.		Page
1.	The ITWS Situation Display and Ribbon Display Terminal.	3
2.	Example of the ITWS Precipitation Product.	11
3.	Example of the ASR-9 Precipitation product.	13
4.	Examples of Anomalous Propagation (AP) in ASR-9 weather channel data.	17
5.	Time series of PEAP for level 2 and greater (*) and level 3 and greater (+) AP.	22
6.	Example of the SCI product.	25
7.	Example of how the SCI product is generated.	27
8.	Example of the ITWS Storm Motion product.	33
9.	Example of the ITWS Storm Extrapolated Position product.	35
10.	Example of the generation of the Storm Motion product.	37
11.	Example of the ITWS microburst detections on the Situation Display.	47
12.	Strategy for the generation of a microburst alert.	49
13.	Example of the ITWS Gust Front Detection product.	57
14.	Example of the Terminal Winds product.	71
15.	1992 Orlando Terminal Winds domains and sensor locations.	73
16.	Data flow for Terminal Winds.	74
17.	Example of the Lightning Detection product.	79
18.	Example of the Text Message product.	85

LIST OF TABLES

Table No.		Page
1.	Minimum Operational Performance Requirements for Initial Operational Capability ITWS Products	7
2.	PEAP and PEW for all-AP, All-weather, and Mixed AP-Weather Cases.	21
3.	Performance Statistics for the Storm Cell Information Algorithm.	30
4.	SEP Scoring Statistics by Location	41
5.	SEP Scoring Statistics by Average Storm Speed Excluding Storms Which Exhibit Growth and/or Decay	42
6.	SEP Scoring Statistics by Average Storm Speed Including Storms Which Exhibit Growth and/or Decay.	43
7.	Contingency Tables for Microburst Algorithm Performance.	50
8.	Performance Statistics for the Microburst Detection Algorithm.	51
9.	Performance Statistics for the Microburst Prediction Algorithm.	53
10.	Requirements for Wind Shift Estimate as a Function of Wind Shift Strength.	60
11.	Gust Front Detection Performance for the ITWS Gust Front Detection Algorithm	61
12.	PFId Results for the ITWS Gust Front Detection Algorithm.	62
13.	PFId Results for the ITWS Gust Front Detection Algorithm. (Wind Shift Strength \geq 15 knots)	63

**LIST OF TABLES
(Continued)**

Table No.		Page
14.	PFlE Results for 10-minute and 20-minute Estimates.	64
15.	CFP Results for 10-minute and 20-minute Estimates.	64
16.	Gust Front Wind Shift Accuracy (Direction Error Tolerance Equals 30 Degrees).	65
17.	Summary of MIGFA Wind Shift Estimate Problems	66
18.	Performance Statistics for the Terminal Winds Algorithm.	76
19.	Performance of the Terminal Weather Text Message Precipitation Predictions.	88
B-1.	Day-by-day performance statistics for the microburst prediction algorithm for Memphis, TN.	99
B-2.	Day-by-day performance statistics for the microburst prediction algorithm for Orlando, FL.	102

1. INTRODUCTION

The Federal Aviation Administration (FAA) Aviation Weather Development Program, with support from Massachusetts Institute of Technology Lincoln Laboratory, is developing the Integrated Terminal Weather System (ITWS) to support safety and traffic management at terminal facilities. The ITWS will produce a fully automated, integrated terminal weather information system to improve the safety, efficiency and capacity of terminal area aviation operations. The ITWS utilizes data from FAA terminal-area weather systems (*e.g.*, Terminal Doppler Weather Radar, Airport Surveillance Radar-9, Low Level Windshear Alert System), National Weather Service (NWS) systems (*e.g.*, Next Generation Weather Radar or NEXRAD) and other systems (*e.g.*, National Meteorological Center, National Lightning Data Network) and commercial aircraft to create its products. Safety products include the identification of hazardous storms, wind shear (microbursts, gust fronts, vertical shears). Traffic management products include three-dimensional gridded winds for use by terminal automation systems, approach and departure corridor winds, and storm movement. The ITWS will be deployed at approximately 45 airports starting in 2000. A functional prototype began operating in 1992 to obtain data for algorithm development and to demonstrate ITWS in an operational environment.

The ITWS will provide for more efficient planning of aircraft movements in the terminal/TRACON area by significantly improving the quality and timeliness of near-term predictions of weather impacting the local area. Identification of weather impacts specific to approach and departure corridors, cornerposts, runways, and the airport surface will enable more efficient coordination of routing strategies. Aviators, dispatchers, traffic managers, controllers and airport operations managers will be able to anticipate rather than just react to these weather impacts. Coordination of the movement of traffic through alternate arrival/departure routes will result in overall increases in capacity. The ability to anticipate impacts (such as the cessation of significant weather in the area) and select optimal routes or holding strategies prior to the arrival of traffic in the area will result in savings of time and fuel.

1.1 1994 DEMONSTRATION AND VALIDATION

During the summer of 1994, ITWS functional prototype displays (Figure 1) were deployed at the Memphis Airport Traffic Control Tower (ATCT) and TRACON (Terminal Radar Approach Control), at the Memphis Air Route Traffic Control Center (ARTCC), at the Orlando International ATCT and TRACON, and at the Jacksonville ARTCC. (The Sun workstation or Situation Display is used to present graphical weather data to traffic managers. The Ribbon Display Terminal is used to display wind shear and microburst alert messages that are read by the controller directly to the pilot.) In addition, ITWS displays were available to the NWS forecast offices at Memphis, TN and Melbourne, FL, to Northwest Airlines in Minneapolis, MN, and to Delta Airlines in Orlando, FL. A principal objective of the ITWS testing was to obtain feedback from operational users on the utility of ITWS products for enhancing safety and reducing delays and controller workload. Weather products were provided in real time in order to assess the utility of ITWS products. ITWS operations at these facilities provided:



Figure 1. The ITWS Situation Display and Ribbon Display Terminal.

1. operational demonstration of the Initial Operational Capability ITWS products as part of the FAA Technical Center's formal Demonstration and Validation (DemVal) as part of the ITWS Operational Test and Evaluation program;
2. data on meteorological phenomena necessary for continued refinement of the ITWS product generation algorithms prior to national deployment; and
3. operational data on the benefits of the ITWS products in meeting the terminal weather information needs of supervisors, traffic managers, controllers, pilots and Central Weather Service Unit meteorologists.

The products provided to the users included:

1. ITWS Precipitation with anomalous propagation clutter removed (maximum range is 50 nm)
2. ASR-9 Precipitation with anomalous propagation flagged
3. Storm Motion
4. Storm Extrapolated Position
5. Storm Cell Information
6. Microburst Detection and Prediction
7. Gust Front Detection, Forecast, and Windshift Estimate
8. Terminal Winds
9. Terminal Weather Text Message
10. Microburst and Wind Shear Countdown Timers
11. Lightning Detection
12. Tornado Detection (pass through from NEXRAD)

13. Long Range Precipitation (pass through from NEXRAD; maximum range is 200 nm)

14. Long Range Storm Motion

1.2 DEMVAL AT MEMPHIS INTERNATIONAL AIRPORT

The ITWS DemVal in Memphis began on 23 May and ended 22 July 1994. Regularly scheduled operations were conducted from 12:00 noon to 7:00 PM local time Monday through Friday, for a total of about 310 hours. In addition, special operations were conducted to support air traffic operations when significant weather occurred outside regularly scheduled operations. For example, ITWS products were provided to users before noon and/or after 7 PM, during the Federal Express pushes (around midnight and 2 AM), and on weekends. These accounted for about 225 hours of additional operations.

The microburst and wind shear products were based on Terminal Doppler Weather Radar (TDWR) data. The TDWR radar was not operational during the first two days of DemVal and from 13 July 1994 until the end of DemVal. The ITWS continued to generate and deliver the remaining products during these time.

1.3 DEMVAL AT ORLANDO INTERNATIONAL AIRPORT

The ITWS DemVal in Orlando began on 11 July and ended 19 August 1994. Regularly scheduled operations were conducted from 12:00 noon to 7:00 PM local time seven days per week, for a total of 280 hours. As in Memphis, special operations were conducted when significant weather occurred outside regularly scheduled operations to support air traffic operations. These accounted for about 10 hours of additional operations.

1.4 ORGANIZATION OF THE REPORT

This report presents technical performance assessments of the ITWS products. Each chapter contains a brief description of the product, a description of the performance assessment, and performance results. The performance of the algorithms is measured against the Minimum Operational Performance Requirements (MOPR) shown in TABLE 1. The MOPR describes the product performance necessary for Air Traffic Control to accept the products as operationally useful. The goals specified in TABLE 1 indicate the desired performance for the products.

TABLE 1.
Minimum and Desired Operational Performance Requirements for
Initial Operational Capability ITWS Products

Parameter	Threshold	Goal
Microburst Prediction		
Probability of false alert	≤ 0.10	≤ 0.05
Prediction lead time	≤ 2 minutes prior to onset of microburst for 60% of predicted valid wet microburst events	≤ 2 minutes prior to onset of the divergent wind shear for 90% of the predicted valid wet microburst events
Gust Front Prediction		
Predicted position times	Position predicted 10 minutes and 20 minutes in advance	Position predicted 10 minutes and 20 minutes in advance
Predicted position accuracy	Predict 70% of gust fronts impacting airport with wind change of ≥ 15 knots 10 minutes in advance	Predict 90% of gust fronts impacting airport with wind change of ≥ 15 knots 10 minutes in advance
Probability of false prediction	Probability of false 10–minute prediction ≤ 0.10 for gust fronts with wind change of ≥ 15 knots	Probability of false 10–minute prediction ≤ 0.10 for gust fronts with wind change of ≥ 15 knots
Wind shift speed accuracy		maximum of ± 5 knots or 10% of speed estimate for 80% of predictions impacting airport
Wind shift direction accuracy		± 30 degrees for 80% of predictions impacting airport
Storm Motion		
Storm speed accuracy	± 5 knots for 90% of storms moving at ≥ 10 knots	± 5 knots for 90% of storms moving at ≥ 5 knots
Storm direction	± 20 degrees for 90% of storms moving at ≥ 10 knots	± 20 degrees for 90% of storms moving at ≥ 5 knots and ± 10 degrees for 50% of storms moving at ≥ 5 knots
Storm Extrapolated Position		
Extrapolated position times	Position projected 10 minutes and 20 minutes into the future	Position projected 10 minutes and 20 minutes into the future
Extrapolated position accuracy	10–minute extrapolation within 2 nm for 80% of storms moving at speeds > 10 knots, excluding those storms exhibiting significant (≥ 2 levels) growth or decay	20–minute extrapolation within 2 nm for 70% of storms moving at speeds > 10 knots, including those storms exhibiting significant growth or decay

TABLE 1. continued.

Storm Cell Information		
Storm Cell Association	≥ 90% of features associated to correct cell	≥ 95% of features associated to correct cell
Storm Cell Information		identify 80% of cells which will grow or decay by over 20% in area in next 20 minutes
ASR-9 AP Edit		
Inadvertent edit	≤ maximum of 10 km ² of or 10% of 90% of contiguous areas with weather reflectivity ≥ level 3	≤ maximum of 10 km ² of or 10% of 90% of contiguous areas with weather reflectivity ≥ level 2
AP editing performance	edit 70% of AP when ASR-9 AP is ≥ level 3 and is at least 2 levels above actual weather reflectivity and spatial extent of AP ≥ 25 km ²	Edit 85% of AP when ASR-9 AP is ≥ level 3 and is at least 2 levels above actual weather reflectivity and spatial extent of AP ≥ 25 km ²
Terminal Winds		
Horizontal Resolution	5 nm out to 30 nm beyond TRACON boundary and below 23,000 ft	1 nm within the TRACON boundaries and below 18,000 ft; 5 nm elsewhere
Vertical Resolution (between levels)	50 millibars	25 mb below 5000 ft AGL and within 15 nm of the TDWR radar; 50 mb elsewhere
Accuracy	± 10 knots 80% of time in regions and at times when both TDWR and NEXRAD have valid velocity data	± 5 knots 90% of time in regions and at times when both TDWR and NEXRAD have valid velocity data

2. ITWS PRECIPITATION AND ASR-9 PRECIPITATION PRODUCTS

The Airport Surveillance Radar (ASR)–9 radar is used in the terminal area to control aircraft. This radar has a weather channel that provides the location and intensity of precipitation on the air traffic controllers' radar screen (Weber, 1986). TRACON controllers use the weather information to aid aircraft in avoiding weather. The ASR–9 radar data are often contaminated by ground clutter due to anomalous propagation (AP). Due to the smoothing process used in the ASR–9, controllers are unable to distinguish between AP and valid weather returns. As a result controllers may attempt to vector aircraft around AP, resulting in increased controller workload and decreased terminal airspace capacity.

The ITWS product suite includes two precipitation products: ITWS Precipitation (AP removed) and the ASR–9 Precipitation (AP flagged in black). The basis for these products is the ASR–9 weather channel output. Both of these products are created by an algorithm called AP–edit, which is described in Klinge–Wilson *et al.*, 1995.

The ITWS Precipitation product is a representation of the location and intensity of weather in the TRACON area. This product may be used for situational awareness and as a planning aid for air traffic managers by showing where weather is located relative to traffic flow patterns. An example of the product is provided in Figure 2.

The ASR–9 Precipitation product explicitly shows where AP is located relative to any ASR–9 radar. Since the ITWS Precipitation product does not replace the ASR–9 weather display on any controllers' displays, the Air Traffic Control (ATC) supervisor or traffic manager may use the AP flagged product to determine the location of AP which may be appearing on the TRACON controllers' displays. An example of this product is provided in Figure 3.

2.1 REMOVING AP CLUTTER FOR ASR-9 DATA

The ASR–9 weather channel provides information on the location and reflectivity of precipitation in the TRACON area. The energy emitted by the radar reflects off of raindrops in the atmosphere. The amount of energy reflected indicates the size and number of the raindrops present; heavy rain is associated with higher intensity levels. The returned signal is passed through a filter that removes ground clutter. The data are smoothed in time over six antenna rotations which results in a 30–second update rate of the precipitation data. The data are also smoothed in space to a resolution of 0.5 nm. During this smoothing process, the spatial extent of the highest intensity levels becomes exaggerated. The output is delivered in the standard NWS VIP (Video Integrator and Processor) 6–level intensity scale.

The data from the ASR–9 weather channel may be contaminated by ground clutter due to AP. In the standard atmosphere, a radar beam typically travels in a slightly curved path whose radius of curvature is

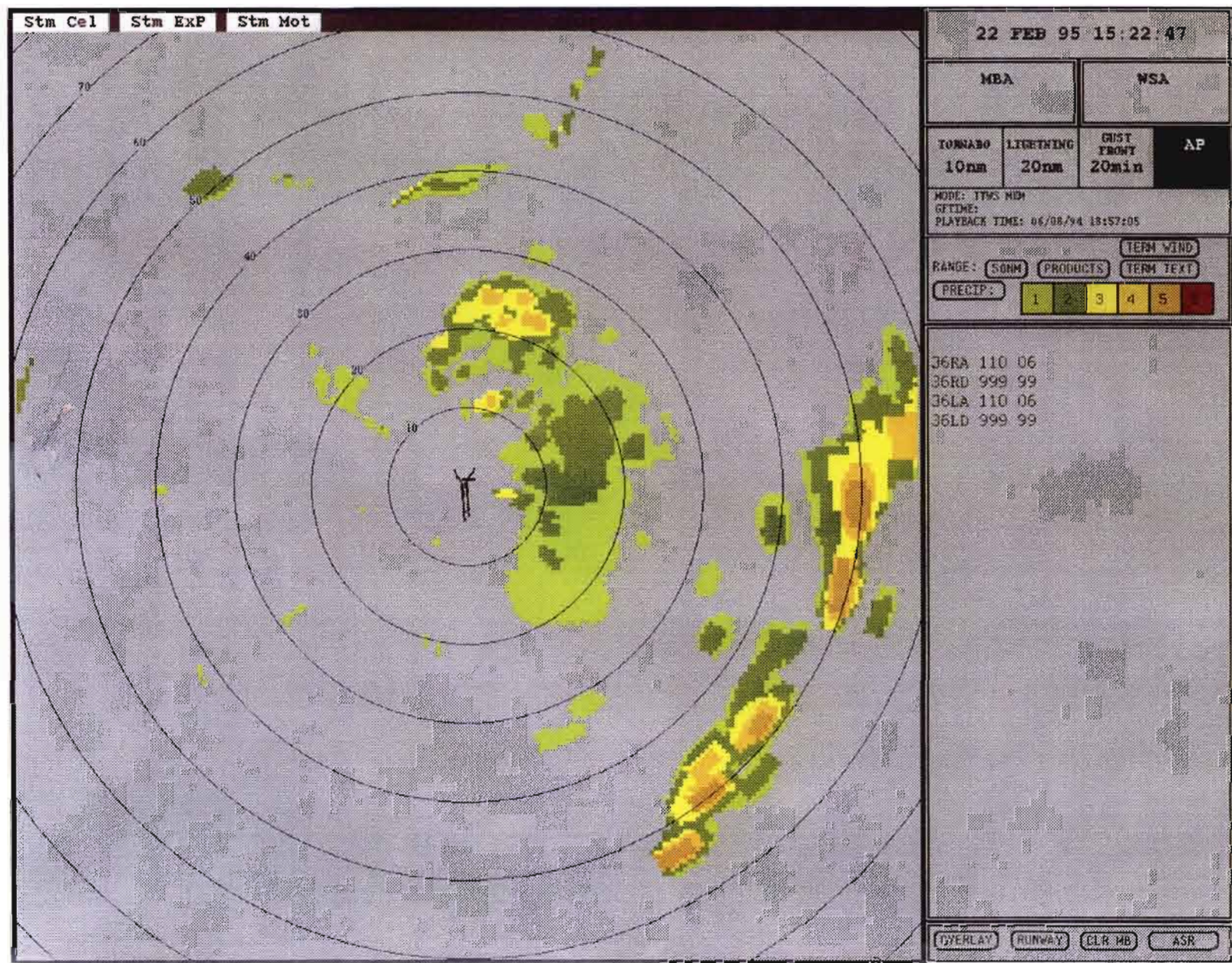
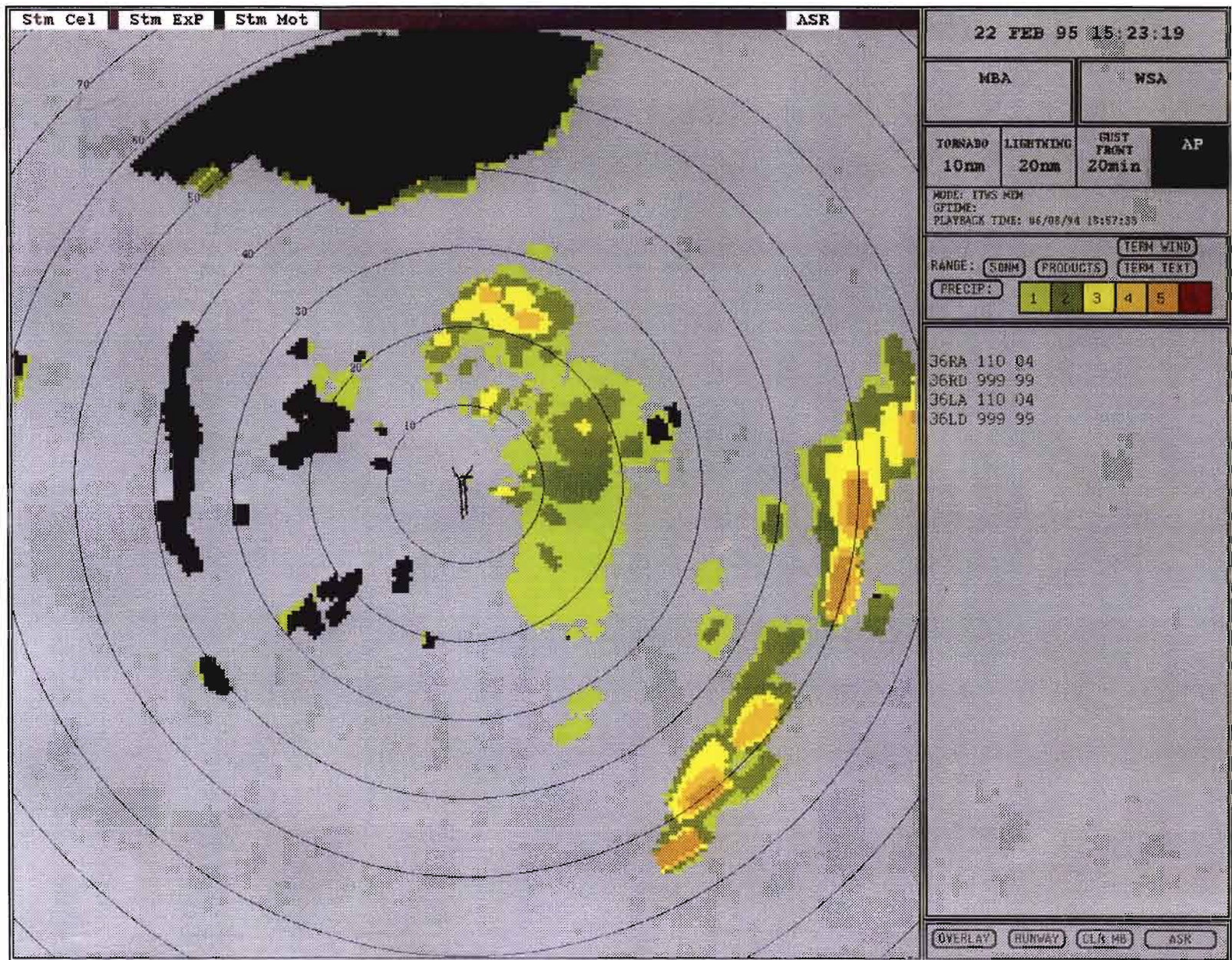

Figure 2. Example of the ITWS Precipitation Product. The six levels are color-coded according to the key at the upper right of the figure. Greens represent lighter precipitation; reds represent heavier precipitation. The AP alert panel in the upper right corner of the Situation Display illuminates (black with white text) when a region of AP is detected that exceeds five square miles.



13

Figure 3. Example of the ASR-9 Precipitation product. The six levels are color-coded according to the key at the upper right of the figure. Greens represent lighter precipitation; reds represent heavier precipitation; black represents anomalous propagation (AP).

greater than the earth's radius. Under superrefraction and ducting conditions, the path of the beam is more highly curved toward the ground. Energy is diverted toward the ground and targets that would normally be below the radar horizon are illuminated. These ground clutter returns are often referred to as anomalous propagation clutter or AP clutter. Because of the spatial and temporal smoothing performed by the ASR-9 weather channel processing, it is difficult for a user to look at a display and distinguish AP clutter from real weather signals.

The atmospheric conditions that cause AP are temperature inversions and moisture gradients. In a standard atmosphere, temperature decreases with height. Sometimes on a clear night, surface cooling reverses the temperature profile such that temperature increases with height near the ground. In this situation, the ASR-9 radar beam is bent downward and strikes the ground. The ground returns look like real weather on the ASR-9 display. Although the skies may be cloud-free, this "nocturnal inversion" causes what seems to be weather returns to appear on the ASR-9 displays. As the inversion strengthens throughout the night, the AP increases in areal extent and intensity. This condition often causes the AP that users see in the late night to early morning hours (Figure 4a).

In addition to the nocturnal inversion situation, the passage of a cold thunderstorm outflow over or near the ASR-9 site sets up an inversion condition (cold air near the ground, warm air aloft), causing AP. In this case, valid weather returns co-exist with, and may even be contaminated by, AP returns. In the latter case, the intensity of real weather appears to be greater than it actually is (Figure 4b).

Weber, *et. al* (1993) described a method for filtering AP from an the ASR-Wind Shear Processor, which is an ASR-9 radar that is specially configured to detect wind shear. This technique makes use of the fact that the Doppler velocity of AP clutter is nearly zero and that the spectrum width is very narrow. Unfortunately, the signal processing techniques developed for that system require access to the Doppler data. For **operational** ASR-9 systems at the ITWS sites, the ITWS will not have access to the Doppler data, only to the 6-level smoothed data. Therefore, the approach described by Weber cannot be applied to operational ASR-9 radars as they are currently configured so a new AP-editing technique using data from the NEXRAD pencil-beam weather radar was developed.

An AP mask is created that contains information on the location of AP and the maximum allowable intensity (VIP level 1 through 6). The creation of the AP mask is initiated by the receipt of the NEXRAD Composite Maximum Reflectivity (comprefl) product. When the complefl is received, it is first searched to determine if any storms are present (*i.e.*, an attempt is made to identify the clear sky, nocturnal inversion case). If the search cannot identify significant weather in the complefl, a mask is created which, when applied to the ASR-9 data, causes all returns to be removed. All returns are removed from subsequent ASR-9 updates until a new complefl is received and a new mask is created (Klingle-Wilson, *et al.*, 1995)

If the search of the complefl indicates that weather reflectivity is present, a pixel-by-pixel (a pixel is 0.5 nm x 0.5 nm) comparison is performed to determine if the ASR-9 data are consistent with the NEXRAD data. ASR-9 data collected at the middle of the NEXRAD volume scan are compared to the complefl to create the AP mask.

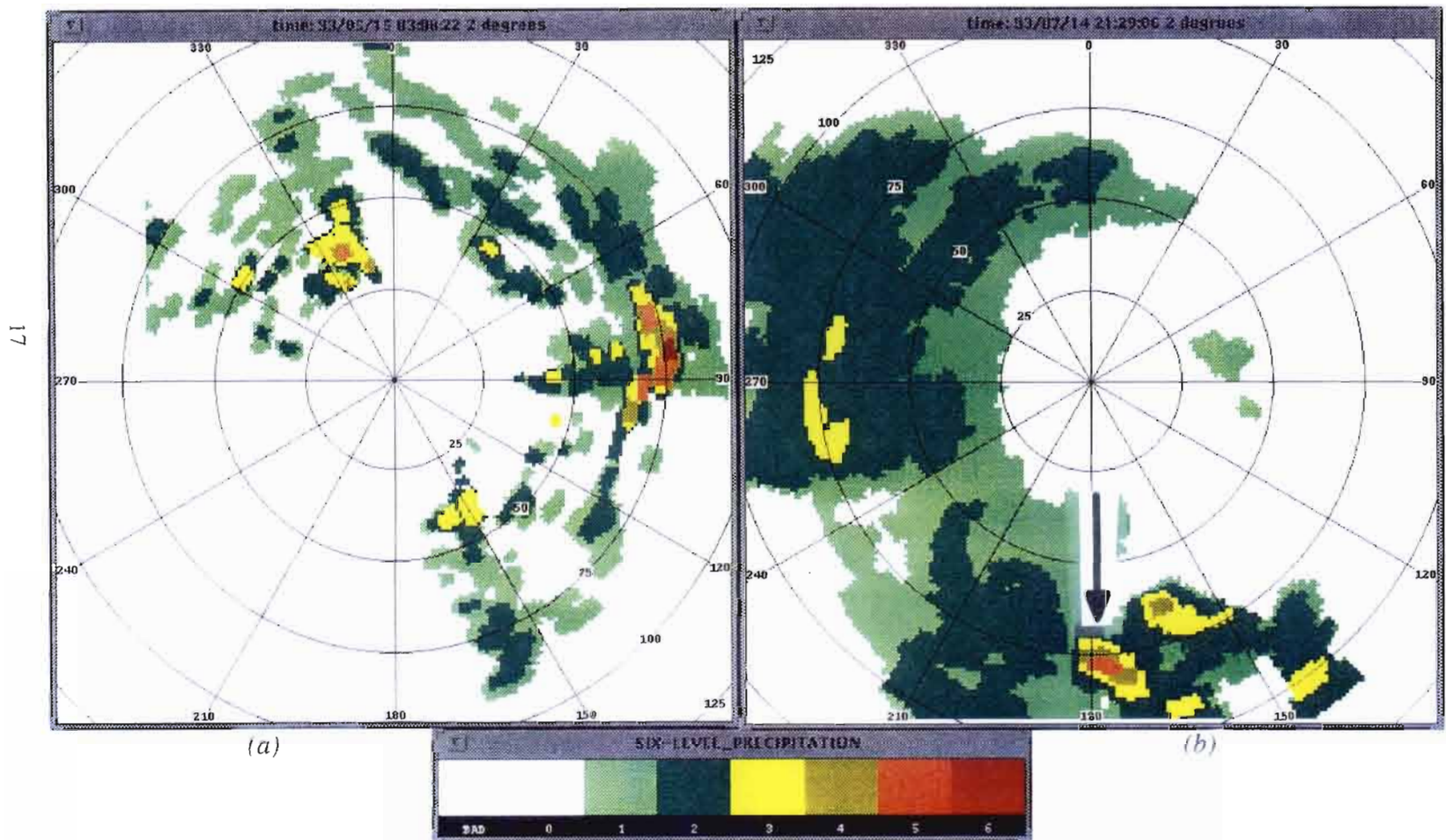

Figure 4. Examples of Anomalous Propagation (AP) in ASR-9 weather channel data. (a) AP created by a nocturnal inversion at Dallas-Ft. Worth International Airport. At the time of this image, the skies were cloud-free. (b) AP created by a cold thunderstorm outflow passing over the ASR-9 radar at Orlando International Airport. The level 5 weather indicated by the arrow is in reality level 3. Contamination of weather returns by AP causes weather levels to appear higher than they really are.

The AP mask is used to edit the ASR-9 scan received immediately after the comprefl product and all subsequent ASR-9 scans until the receipt of a new comprefl. Only those grid points that are identified as containing AP in the original comparison are edited. Depending on the NEXRAD volume scan being used, the AP mask could be as much as nine minutes older than the ASR-9 data being edited.

Since weather moves (especially relative to the AP mask) the possibility exists that real weather will propagate into an area that was previously occupied by AP. Unless corrective action is taken, the valid weather returns would be edited in accordance with the AP mask. To account for motion, each edited ASR-9 scan is passed to a routine that finds cells of at least VIP level 3. Motion is estimated by a correlation tracking technique (Chornoboy, 1992; Chornoboy and Matlin, 1994) and assigned to each cell. From this, the time at which real weather is expected to overlap AP regions is computed. When the overlap time has expired, the pixel in the AP mask is "turned off" such that the ASR-9 return is passed through without change.

2.2 TECHNICAL PERFORMANCE ASSESSMENT AND RESULTS

There are basically three cases that must be considered when assessing the technical performance of the AP-edit algorithm: all AP, all weather, and mixed AP and weather. In the first case, all returns in the ASR-9 data are AP (*i.e.*, the clear sky, nocturnal inversion case). In the second case, all of the returns in the ASR-9 data are from real weather. In the third (and most stressful for the algorithm), AP and weather returns co-exist; AP can be unassociated with any valid weather returns (referred to as "clear air AP") and weather returns may be anomalously high due to contamination by AP. Although the performance metrics for each of the cases are the same, the performance of the algorithm with respect to these cases is generally considered independently in order to highlight the conditions under which the algorithm might fail.

Truth is generated by a human expert who compares raw ASR-9 data to NEXRAD data. An ASR-9 datum must be at least VIP level 2 to be scored. (According to the ITWS Users' Working Group conducted in November 1993, level 1 precipitation is not considered operationally significant. In addition, the NEXRAD radar is so sensitive that level 1 AP is often "confirmed" by NEXRAD clear air returns.) If the NEXRAD data contain no areas greater than 5 nm² of valid weather returns greater than 17 dBZ, a flag is set such that the automatic scoring software recognizes that all ASR-9 returns should be removed.

If weather is present in the NEXRAD data, visual comparisons of the ASR-9 and NEXRAD data (before and after the ASR-9 data) are performed. Any returns in the ASR-9 data that do not correspond to valid weather returns in the NEXRAD data, either in location or intensity, are assumed to be AP. Polygons are drawn around those areas. These polygons are entered into a file, along with flags indicating:

- a. that the truther is unsure if the polygon contains AP,
- b. that the polygon contains AP but the truther is unsure of the correct value of the weather, or

- c. that the polygon contains AP and what the correct weather level should be.

Truth is generated for ASR-9 scans that are separated in time by about 90 seconds (about every third ASR-9 update).

The performance metrics for the AP-edit algorithm are PEAP (probability of editing AP) and PEW (probability of editing weather). PEAP is given by the number of AP pixels correctly edited divided by the total number of AP pixels. PEW is given by the number of weather weather regions incorrectly edited divided by the total number of weather regions, so the goal is a high PEAP and a low PEW. The MOPR for the AP-edit algorithm are:

1. \leq maximum of 10 km² or 10 percent of 90 percent of contiguous areas with weather reflectivity \geq level 3. That is, no more than the greater of 2.9 nm² (10 km²) or 10 percent of the contiguous areas of \geq VIP level 3 weather will be edited (*i.e.*, PEW \leq 0.10).
2. edit 70 percent (*i.e.*, PEAP \geq 0.70) of AP when ASR-9 AP is at least level 3 and is two levels above actual weather reflectivity, and the spatial extent of AP exceeds 13.5 nm² (25 km²).

Table 2 provides the results of the performance analysis for nine days in Memphis (six hours from three all-AP days, eight hours from three all-weather days, and four hours from three mixed days) and seven days in Orlando (seven hours from three all-weather days, two and a half hours from three mixed days, and 40 minutes from one all-AP day.). The overall performance for these cases significantly exceeds the MOPR.

One would expect that the all-AP days would have a PEAP of 1.0. When the all-AP condition is identified, the ASR-9 scan is "wiped clean". The ability to identify the all-AP condition is directly tied to the quality of the NEXRAD data. It is assumed that comprefl is free of ground clutter and AP contamination. Experience in Memphis has shown that this is seldom the case. The comprefl on a clear-air day then does not pass the no-weather test and the AP-edit algorithm is forced into the more conservative pixel-by-pixel edit. ASR-9 AP can be confirmed as real weather based on NEXRAD ground clutter and AP, with a resulting decrease in PEAP.

The AP mask is created at the NEXRAD update rate. If the ASR-9 scan used to create the AP mask is from the middle of the NEXRAD six-minute volume scan, the AP mask is three minutes old relative to the first ASR-9 scan to which it is applied and nine minutes older than the last application. Evolution of AP (and weather) for that time is not represented in the AP mask. As the AP mask ages, the editing performance AP decreases. This is exemplified in Figure 5.

Table 2.
PEAP and PEW for all-AP, All-weather, and Mixed AP-Weather Cases.

	All AP	All Weather	Mixed
Memphis			
PEAP (\geq level 2)	0.97	–	0.80
PEAP (\geq level 3)	0.98	–	0.96
PEW	–	0.00	0.01
Orlando			
PEAP (\geq level 2)	0.94	–	0.85
PEAP (\geq level 3)	0.97	–	0.76
PEW	–	0.01	0.02
Both Locations			
PEAP (\geq level 2)	0.97	–	0.81
PEAP (\geq level 3)	0.98	–	0.95
PEW	–	0.01	0.02

The data in Figure 5 are from 2300 to 2330 UT 17 July 1994 in Memphis (a mixed case). The vertical lines indicate the times of new AP masks. Generally, the highest PEAP values are found when the AP mask is first applied to the ASR-9 data, when the AP mask is newest. As the AP mask ages relative to the ASR-9 data, performance drops because AP continues to evolve, making the AP mask less representative of the situation. This trend is more pronounced when the level 2 AP is included in the analysis. It is interesting to note that over the time period, overall performance improves because the AP intensified but did not develop beyond the original AP area.

There was less AP in Orlando than in Memphis. The three Orlando mixed cases had smaller AP areas than the Memphis mixed cases. In the Memphis mixed cases, the total number of AP pixels of at least level 3 was on the order of 2×10^5 ; for at least level 2, the total number was around 5×10^5 . In the Orlando mixed cases, the total number of AP pixels of at least level 3 was on the order of 1×10^4 ; for at least level 2, the total number was around 5×10^4 . The PEAP and PEW values vary from case to case. In general, the algorithm performs much better if the weather or AP is wide-spread.

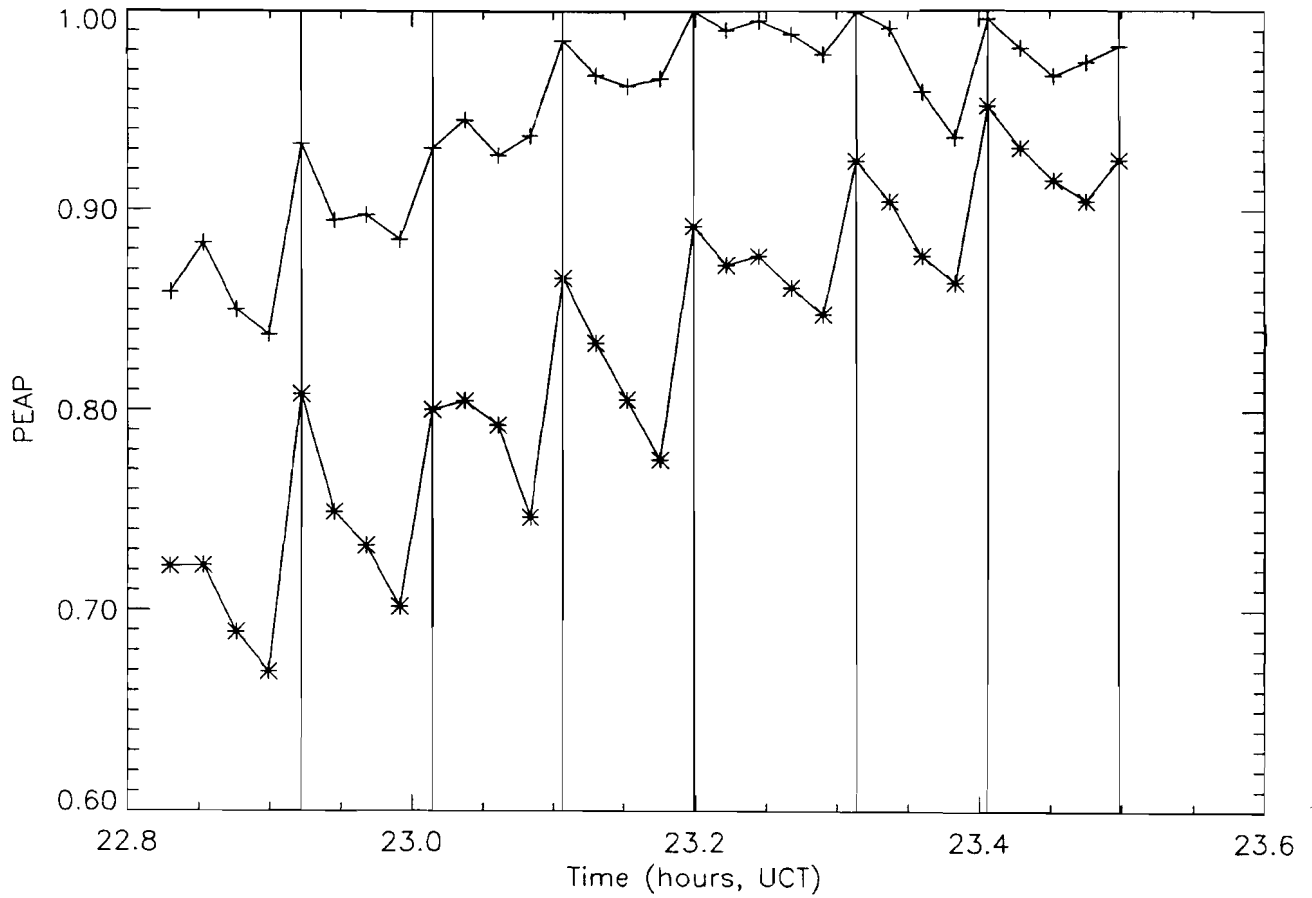

Figure 5. Time series of PEAP for level 2 and greater () and level 3 and greater (+) AP.*

The approach used to remove AP from ASR-9 data is very conservative to insure that real weather returns are not inadvertently identified as AP and removed. Nonetheless, preliminary scoring results indicate that over 80 percent of AP is correctly edited from the ASR-9 data. In addition, less than one percent of contiguous weather regions are edited.

3. ITWS STORM CELL INFORMATION PRODUCT

The ITWS Storm Cell Information (SCI) product provides a textual description of storm attributes which cannot be deduced from the ITWS Precipitation product alone. This text describes the height of the storm (echo top), whether the storm cell contains hail and/or lightning, and whether the storm contains a mesocyclone (that is, a strong rotation with strong updrafts). The term “severe storm circulation” is used for a mesocyclone detection. This product uses the ITWS precipitation product to identify storm cells, the NWS NEXRAD radar for identification of echo tops, hail, and mesocyclones, and the National Lightning Detection Network for cloud-to-ground lightning detection. SCI is used for situational awareness and as an aid to planning traffic flow in the TRACON area. An example of the product is provided in Figure 6.

3.1 STORM CELL INFORMATION ALGORITHM

The generation of SCI text is performed in three basic steps: gridding of storm information, storm cell detection, and text generation (Dasey, *et al.*, 1995). Mesocyclones and severe hail (greater than 3/4-inch diameter at the ground) detections from the NWS NEXRAD radar are provided as point locations. Hail detections are converted into areas (or grids) based on their association with high reflectivity regions identified from the comprefl. Mesocyclone detections are converted to grids based on their physical size. The echo tops from NEXRAD are already provided in grid format. Cloud-to-ground lightning stroke detections are accumulated into a gridded image which depicts a two-minute average lightning flashrate. Each of these grids is reoriented so it is centered on the airport reference point. Furthermore, these grids may be the result of data which, in the case of hail, echo tops and mesocyclones, are as much as six minutes old. Storm motion estimates from the ITWS Storm Motion product are used to compensate these gridded data for motion which occurred over the age of the detections.

Running in parallel to this gridding process is an algorithm which uses the ITWS Precipitation map to create outlines of precipitation at VIP levels 3 through 6. A final association process searches the area within an outline, which defines each storm cell detection, for sufficiently high levels of the other hazards. If the probability of severe hail, or if lightning flashrate is sufficient, a hail or lightning text message is added to the SCI text box. If a mesocyclone is present, this is indicated as a “SEVERE STORM CIRCULATION” in the SCI text box. Finally, the maximum echo top within the cell outline is reported. SCI information is determined within the highest precipitation level of a storm. If that precipitation area is considered too small, the cell is dilated on all sides repeatedly until a minimum area threshold is met.

Figure 7 shows a four panel display illustrating the generation of the product. The upper left panel illustrates the VIP level 4 and 5 storm cell outlines overlaid on the ITWS precipitation grid for an Orlando storm. The upper right panel shows how these outlines correspond to the grid of the probability of severe hail, with the lightning flashrate and echo top grids shown in the lower left and right, respectively. The extreme lower right corner displays the SCI text that is generated for the VIP level 5 outlines, based on the overlap of that outline with the grids.

3.2 TECHNICAL PERFORMANCE ASSESSMENT AND RESULTS

The measures of performance for the SCI product are simply whether or not the reported hazards for a given storm cell match those in the local area surrounding the cell as they were reported by the various sen-

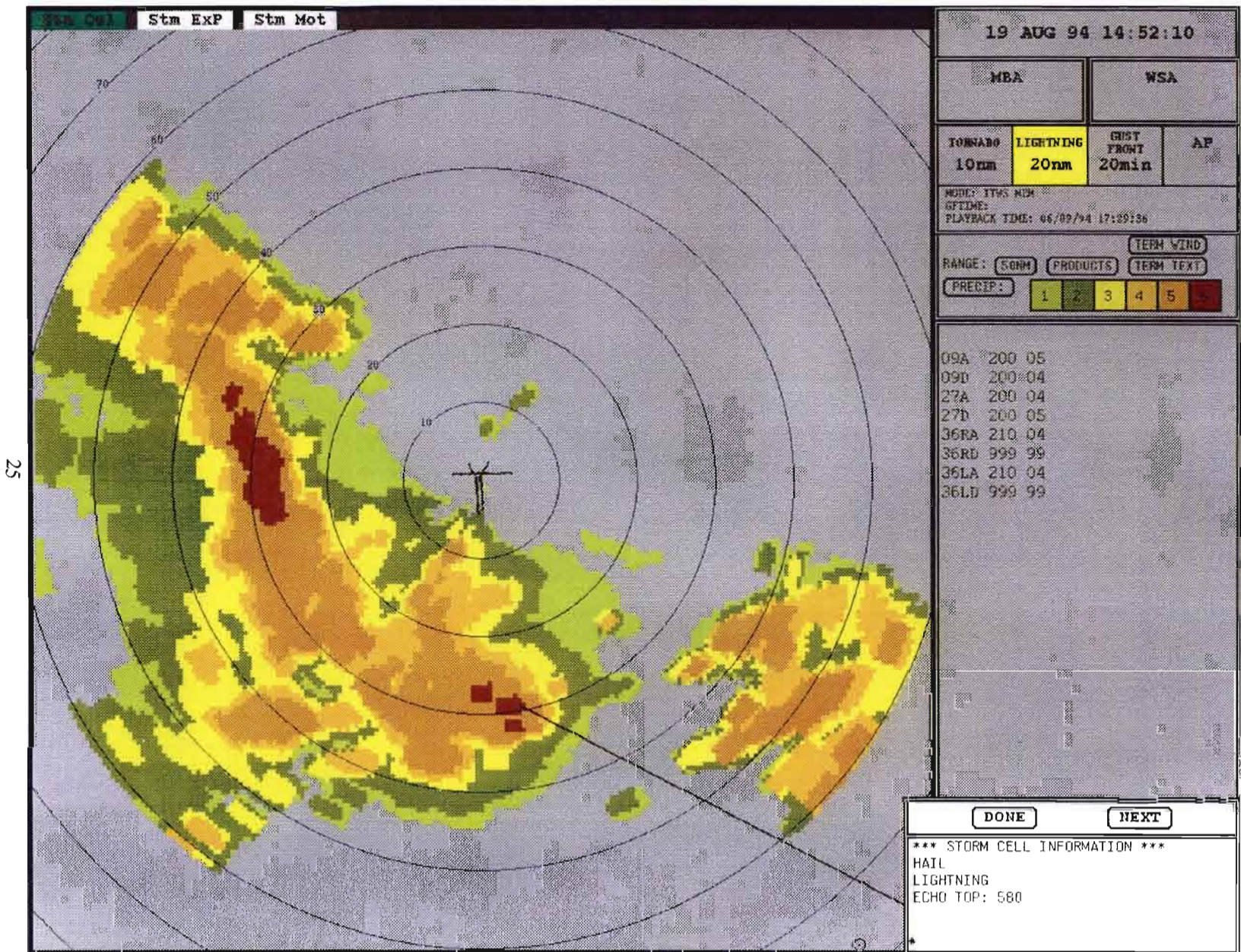

Figure 6. Example of the SCI product. The text box at the lower right corner of the figure provides information about the storm cell to which the black line is drawn. HAIL indicates a greater than 50 percent probability of the presence of severe hail at the ground; LIGHTNING indicates a cloud-to-ground lightning flashrate of three flashes per minute in the storm; ECHO TOP provides an estimate of the echo top of the storm above ground level in units of (x 100) feet; SEVERE STORM indicates the presence of strongly rotating horizontal winds and strong updrafts in the storm.

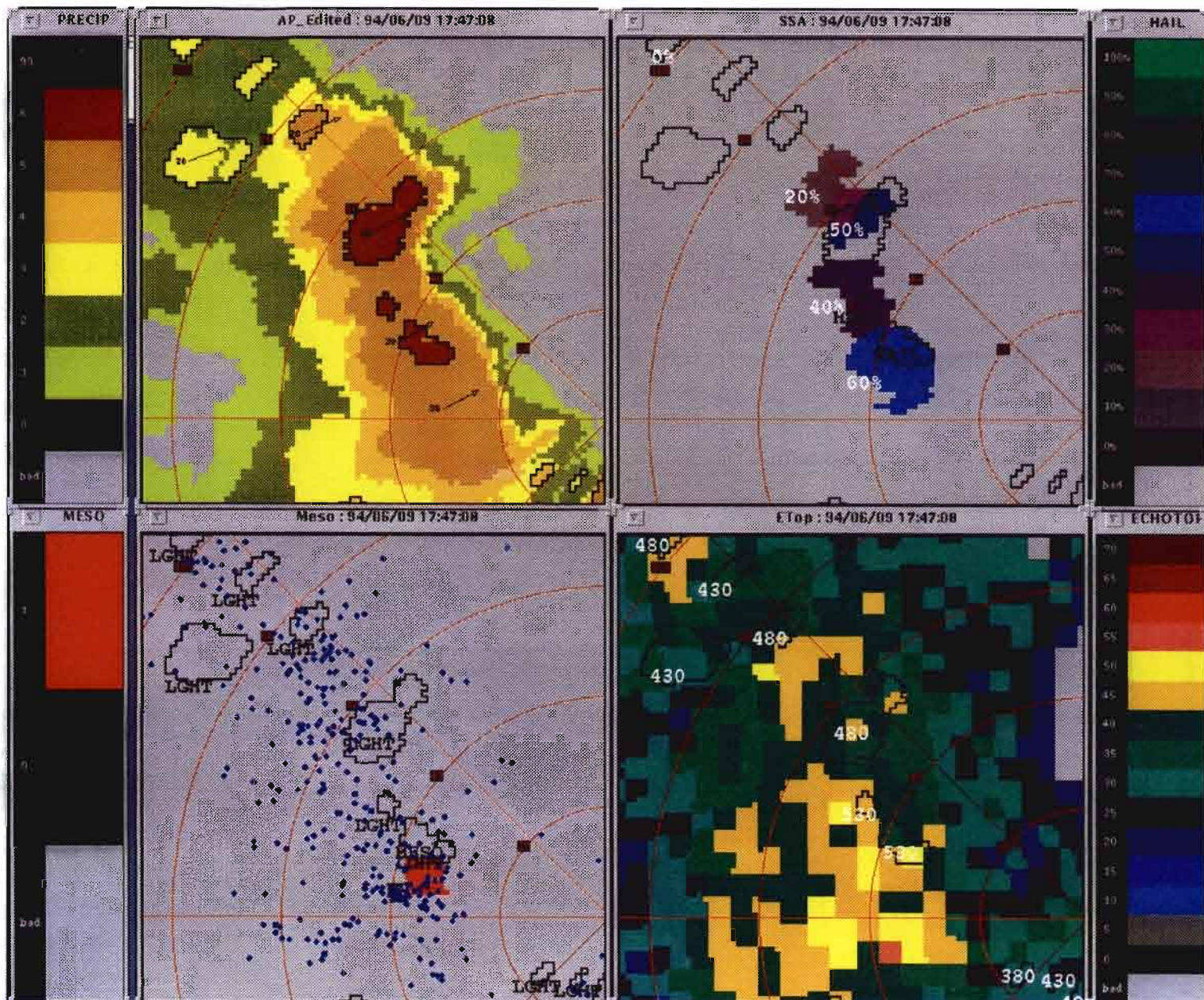

Figure 7. Example of how the SCI product is generated. Storm cell outlines are overlaid on (a) the ITWS 6-level precipitation, (b) probability of severe hail (percent), (c) lightning flashrate (flashes per minute; blue dots) and mesocyclone detections (red squares), and (d) echo tops (x1000 feet). The data for each grid are searched within the outlines to determine the appropriate information to issue in the text box.

sors. Correct identification of the hazards associated with a given storm cell is a hit. The presence of a particular hazard in the vicinity of the storm cell not reported by the SCI is a miss. The association of a hazard to a storm cell that does not contain that hazard is a false alarm.

Truth for the SCI product consists of the output from the Storm Structures Algorithm (SSA; Eilts *et al.*, 1995) package (hail and mesocyclone detections), the NEXRAD Echo Tops product used in the association of echo tops to cells, and lightning detections. Since the SSA products are (or will be) NEXRAD products, it is assumed that these inputs will be validated by the NEXRAD Program Support Facility. Lightning detections are validated in a separate analysis in Chapter VIII.

The SCI product is generated by overlaying reflectivity contours (storm cells) on the various data fields and searching within the contour to determine the value to be assigned to the storm cell. These values are reported in the SCI text box. The minimum area to be searched is 42 nm². If a contour does not encompass the minimum search area, it is dilated by the grid resolution (0.5 nm) on all sides repeatedly until the minimum search area is met.

For hail, a hit is declared if the search area of a storm cell contains a Probability of Severe Hail (POSH) value equaling or exceeding a threshold (currently 60 percent) and "HAIL" is reported in the SCI text box. A miss is declared if the search area of a storm cell contains a POSH value of at least 60 percent and "HAIL" is not reported in the SCI text box. In addition, a miss is declared if a POSH value of at least 60 percent is not associated with a storm cell. A false alarm is declared for a storm cell whose SCI text box contains "HAIL" but whose search area does not contain a POSH value of at least 60 percent.

Mesocyclone detections are represented by a bounding boxes whose x,y dimensions are equal to the radius of the largest two-dimensional shear feature. A hit is declared if the search area of a storm cell overlaps any part of a mesocyclone detection and the SCI text box contains the message "SEVERE STORM CIRCULATION". A miss is declared if an overlap occurs but the SCI text box does not contain "SEVERE STORM CIRCULATION" or a mesocyclone bounding box is not associated to a storm cell. A false alarm is declared for a storm cell whose SCI text box contains "SEVERE STORM CIRCULATION" but whose search area does not overlap a mesocyclone detection.

For lightning, storm cell contours are overlaid on a map of cloud-to-ground lightning flashes that occurred within the two minutes prior to the storm cells. A hit is declared if the storm cell search area contains at least one lightning flash and the SCI text box contains the message "LIGHTNING". A miss is declared if a search area contains at least one lightning flash but the SCI text box does not contain "LIGHTNING". A false alarm is declared for a storm cell whose SCI text box contains "LIGHTNING" but whose search area does not contain at least one lightning flash.

For echo tops, a hit is declared if the maximum value of echo top that is found within the search area is reported in the SCI text box. A miss is declared if the echo top value reported in the SCI text box is not the maximum found within the search area or if there is no echo top report in the SCI text box when echo top value fall within the search area. A false alarm is declared when the reported echo top exceeds the maximum value falling within the search area or when echo top is not reported.

The MOPR for this product is at least 90 percent correct cell association unless constrained by sensor input. That is, 90 percent of storm phenomena (hail, lightning, mesocyclones, and echo tops) will be associated to the correct storm cell (*i.e.*, regions of high reflectivity). The results of the analysis for six days in Memphis and two days in Orlando are presented in TABLE 3. Blank entries in the table indicate that the hazard was not present. Over all days, the algorithm exceeded the MOPR for all hazards. The performance in Memphis and Orlando did not differ greatly.

TABLE 3.
Performance Statistics for the Storm Cell Information Algorithm.

Date	HAIL	MESOCYCLONE	LIGHTNING	ECHO TOP
Memphis				
04/15/94	–	1.0 (10/10)	0.86 (398/461)	1.0 (1015/1015)
06/08/94	–	–	0.90 (388/429)	1.0 (920/920)
06/09/94	0.90 (85/94)	0.50 (5/10)	0.97 (912/945)	1.0 (1072/1075)
06/16/94	–	–	0.92 (499/540)	1.0 (920/920)
06/21/94	0.97 (33/34)	–	0.92 (524/568)	1.0 (983/983)
06/26/94	0.98 (109/111)	1.0 (57/57)	0.98 (208/212)	1.0 (221/221)
Total	0.95 (227/239)	0.94 (72/77)	0.93 (2929/3155)	1.0 (5131/5134)
Orlando				
07/12/94	1.0 (5/5)	–	0.89 (614/692)	1.0 (1020/1020)
07/16/94	0.93 (28/30)	–	0.93 (1251/1333)	1.0 (1723/1723)
Total	0.94 (33/35)	–	0.92 (1865/2025)	1.0 (2743/2743)
Both				
Total	0.95 (259/274)	0.94 (72/77)	0.93 (4794/5180)	1.0 (7874/7877)

4. ITWS STORM MOTION AND STORM EXTRAPOLATED POSITION PRODUCTS

The ITWS Storm Motion product provides an estimate of the motion (speed and direction) of storms in the terminal area. Motion is indicated using arrows (for direction) and alphanumerics (for speed). When overlaid on the ITWS Precipitation product, Storm Motion may be used as a planning aid to better anticipate the need for runway and airspace configuration changes. An example of the Storm Motion product overlaid on the ITWS Precipitation product is provided in Figure 8.

The Storm Extrapolated Position (SEP) product should be viewed as a supplement to the Storm Motion product. It provides leading-edge contours of cells and/or cell groups and extrapolates these contours to indicate the likely positions of these cells projected 10 and 20 minutes into the future, assisting the users in estimating the time at which a given cell will impact a terminal route or runway. The extrapolations may be used to estimate the impact times of fast-moving storms. An example of the product is shown in Figure 9.

4.1 STORM MOTION/STORM EXTRAPOLATED POSITION ALGORITHMS

4.1.1 Using ITWS Precipitation

The Storm Motion product uses the ASR-9 weather channel data for its knowledge of current precipitation levels. An image processing technique is used that compares two precipitation images which are separated in time. It is assumed that differences between the two images result solely from the motion of the weather; storm growth and decay are not considered. Briefly, the method segments a radar image into overlapping 15 nm x 15 nm regions. For the DemVal, the two images were thresholded at NWS level 3. Spatial correlation is performed between the weather in a given 15 nm x 15 nm region over the two scans. Figure 10 illustrates this spatial partitioning and full-grid analysis.

The ability of the technique to compute motion is a function of the resolution of the input data and the speed of the weather. The update rate of the ASR-9 precipitation map is 30 seconds, but storms do not move far enough in 30 seconds for the technique to compute an accurate motion. Hence, Storm Motion estimates are computed by comparing images that are nominally separated in time by four minutes. This sampling, coupled with the map's spatial resolution, limits the accuracy of motion vectors to ± 3.8 knots (90 percent confidence interval; Chornoboy and Matlin, 1994). However, this can be mitigated somewhat by taking advantage of the ASR-9 high update rate.

In convective situations, storm motion can represent a composite of actual storm movement and apparent motion due to growth and decay. For example, Midwest squall lines are usually observed to move from

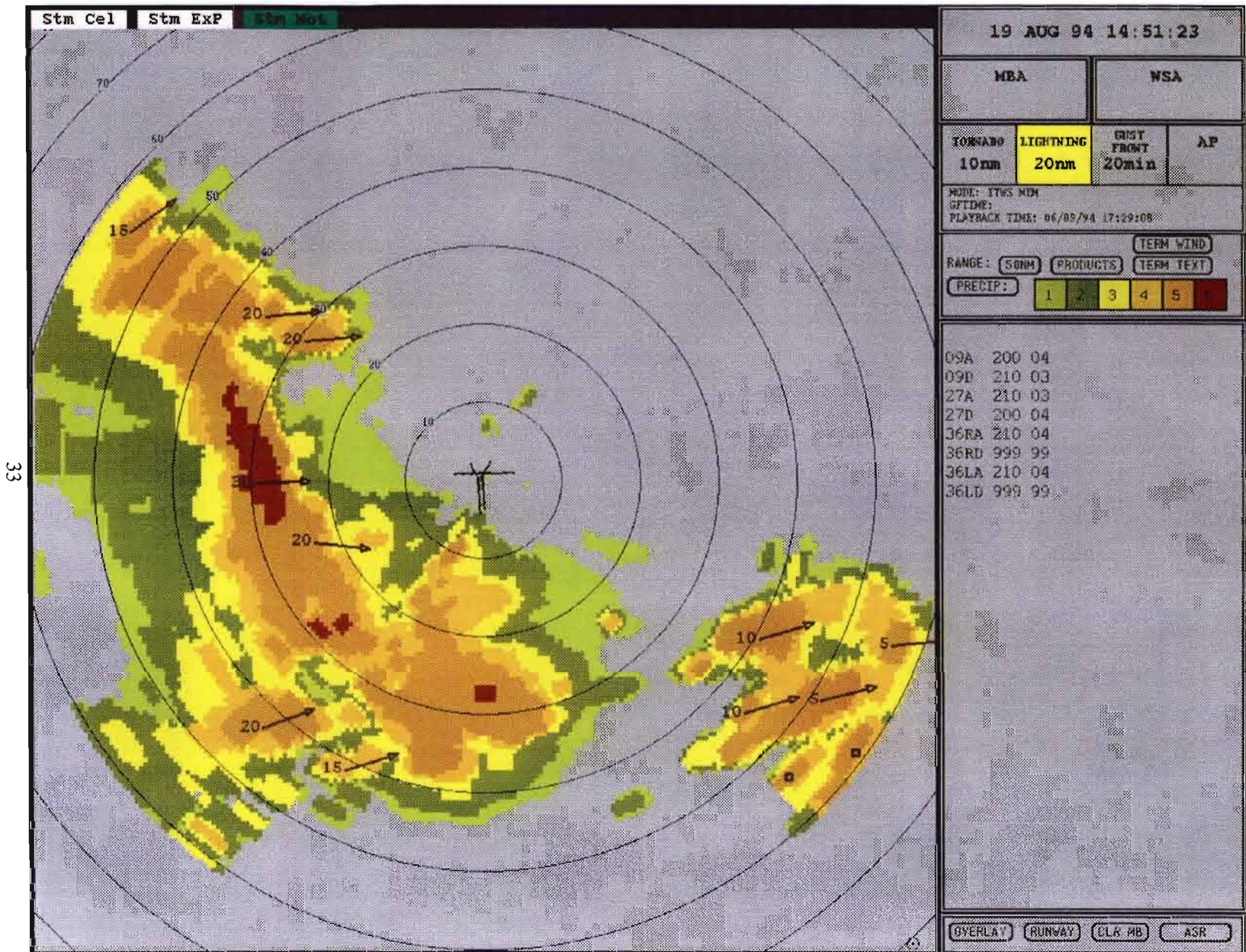

Figure 8. Example of the ITWS Storm Motion product. The arrows overlaying the precipitation product indicate the direction of motion of the storm and the number positioned at the base of the arrow indicates speed of motion in knots

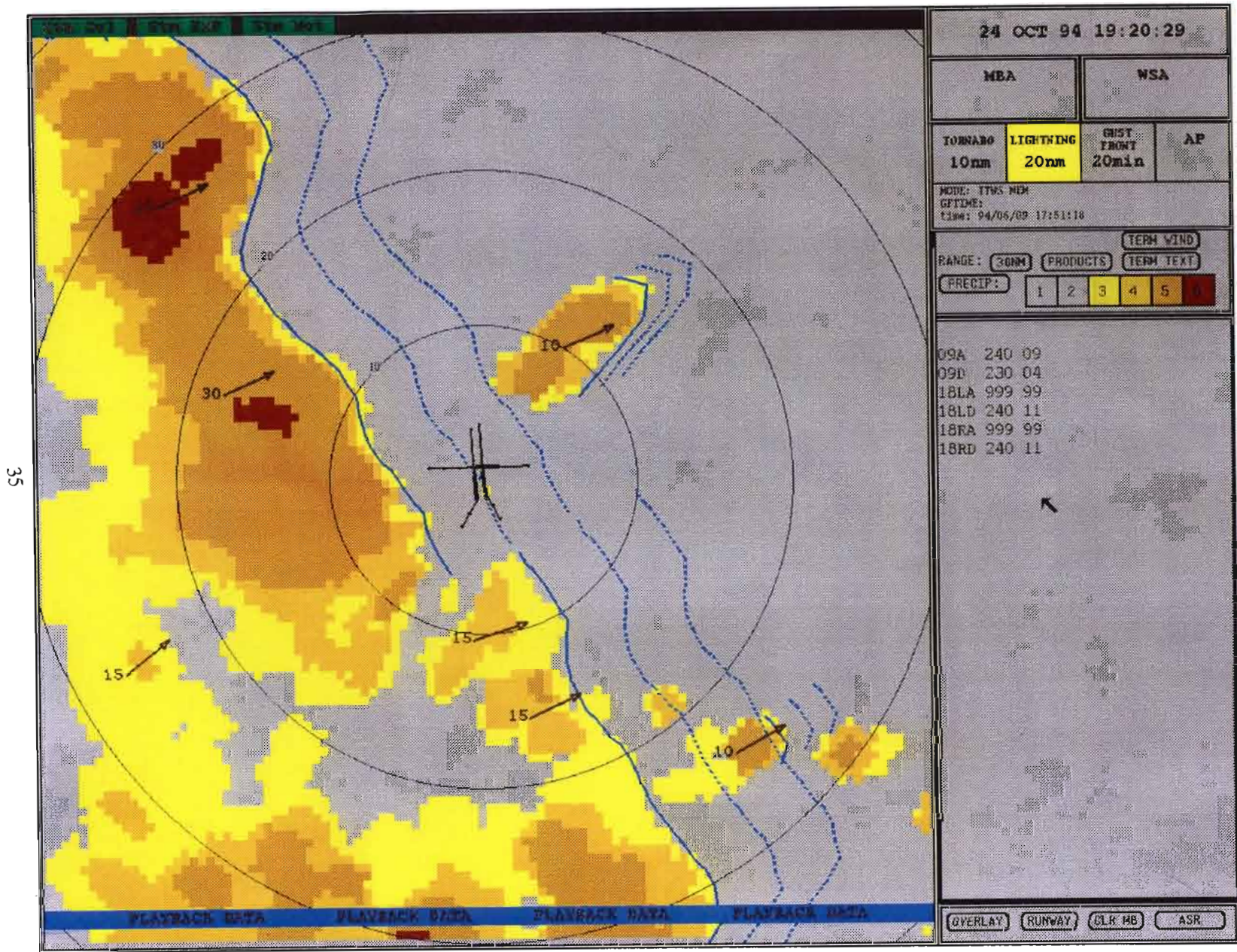

Figure 9. Example of the ITWS Storm Extrapolated Position product. The solid blue line indicates the current location of the leading edge of the level 3 or greater precipitation; the dashed lines are the 10- and 20-minute extrapolated positions of the leading edge.

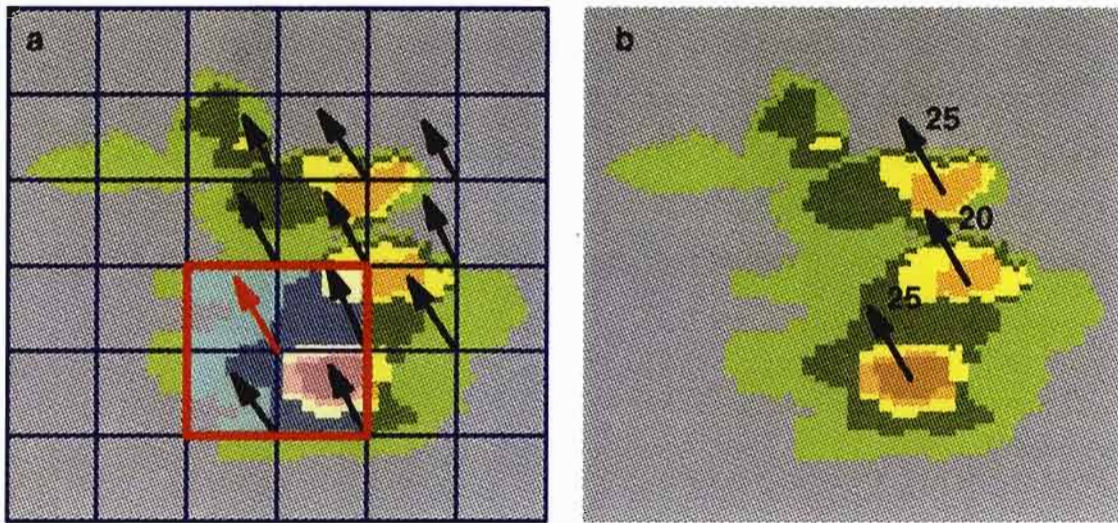

Figure 10. Example of the generation of the Storm Motion product. The Storm Motion algorithm takes a 15 nm x 15 nm area (highlighted region in a) and finds the best match for it in a scan from four to five minutes earlier. This procedure is repeated using overlapping regions to construct a grid with 7.5 nm spacing. For external display, Storm Motion interpolates the grid to cells as illustrated in b.

west to east. Individual storm cells move to the northeast within the squall line, with new cells developing at the southern end of the squall line and old cells dissipating at the northern end. In situations of extended "steady-state" growth and decay, the Storm Motion vector could indicate movement to the east-northeast. In general, however, Storm Motion is dominated by the movement of the individual cells.

Storm Extrapolated Position interprets the internal motion grid computed by the Storm Motion algorithm and, like Storm Motion, uses the ASR-9 weather channel data for its knowledge of current precipitation levels. The SEP algorithm (Chornoboy and Matlin, 1994) computes storm contours using NWS level 3 as its contouring level. Before contouring, however, closely associated cells are grouped, filling in and smoothing level 3 gaps of 1 to 2 nm. The internal Storm Motion grid is used to determine leading and trailing edges and only the leading edge of each contour is displayed. These contours are extrapolated 10 and 20 minutes into the future. The algorithm designates a certain subset of SEP contours and vectors as "default" for display.

4.1.2 Using NEXRAD Data

Beyond the range of the ASR-9 coverage, NEXRAD data is used to infer motion. Processing is analogous to ASR-9 usage except that images are separated in time by the NEXRAD volume scan time (six to 10 minutes) and may have a decreased spatial resolution. Hence, long-range motion requires a few changes in algorithm parameters to accommodate NEXRAD's data resolution and update rate. For DemVal, a 2.2 nm

x 2.2 nm NEXRAD composite product (nominal update rate of six minutes) was used. The resolution limitations for motion detection requires looking across NEXRAD maps separated in time by 12 minutes. Consequently, there is a reduction in the expected accuracy for motion estimates using the NEXRAD data.

4.2 TECHNICAL PERFORMANCE ASSESSMENT AND RESULTS

The MOPR for Storm Motion are:

1. Storm Speed Accuracy: ± 5 knots for 90 percent of storms moving at 10 knots or greater.
2. Storm Direction Accuracy: ± 20 degrees for 90 percent of storms moving at 10 knots or greater.

The Storm Motion algorithm implemented in DemVal was changed little from earlier implementations and as such can be expected to meet the performance characteristics documented by Chornoboy (1991). Although that report focused on performance using TDWR data, it can be taken as a lower bound on expected DemVal performance, as discussed by Chornoboy and Matlin (1994).

The validation of requirements for speed accuracy and direction accuracy using recorded DemVal data is a planned exercise which is currently underway, and these results will be provided in a future report. Briefly, human scorers will work a set of DemVal data days (selected from the days considered below) and create a truth data base that represents the human's capacity to detect and measure storm motion. This truth data base will be characterized for its variation and used to score Storm Motion performance accordingly.

There are no formal performance requirements that apply to the long-range motion product, which utilizes the same algorithm albeit with a NEXRAD derived data source. The expected degradation in performance owing to decreased sampling resolution and update rate have been noted above.

The MOPR for Storm Extrapolated Position are:

1. Extrapolated Position Times: Position projected 10 minutes and 20 minutes into the future
2. Extrapolated Position Accuracy: 10-minute extrapolation within 2 nm for 80 percent of storms moving at speeds of greater than 10 knots, without growth or decay of 2 levels or greater

During DemVal, the 10- and 20-minute extrapolated positions were computed and displayed as required in the MOPR.

Appropriateness of the smoothed contour representation is based on a point-by-point tally of contour coordinates exported for external display. Truth consists of unsmoothed contours, drawn at the actual storm level boundary, and the scoring measures the distance between each point of the smoothed contour and the truth contour. The distance between a point and a given contour curve is the smallest distance obtained from point-to-point comparison of the reference point with each point (coordinate) in the contour curve.

Accuracy of extrapolated position contours is assessed as a binary statistic applied to each 10-minute contour exported for display. That is, a contour segment is subjectively scored as being either consistent or not consistent with its accuracy criterion. A tally of accurate 10-minute contours is made. Accuracy at the level of 20-minute extrapolation is the same as that of 10-minute extrapolation except to the extent growth and decay degrade performance. The displacement error due to ITWS computational inaccuracies for the leading-edge displacement shall be less than 1 nm 95 percent of the time for a 10-minute extrapolation.

A subjective scoring method for SEP contours has been described by Chornoboy and Matlin (1994), and that report also includes preliminary results from 1993 operations in Orlando, FL and Dallas, TX. As detailed below, this analysis was extended to form a preliminary evaluation of DemVal data.

Storm growth and decay are significant factors for which the current SEP algorithm does not account. Adherence to the MOPR is conditioned on non-obscuration by observed significant growth and/or decay. Specifically, SEP contours were identified as belonging to one of three categories: Hit, Miss and Miss due to Evolution (significant growth and/or decay). A hit is an SEP that was a human expert has determined is within 1 nm of the true edge. The category of Miss/Evolution represents SEPs that could not be scored for accuracy owing to ambiguity introduced by growth and decay (a few instances arose where neither growth nor decay could be cited explicitly, yet the scorer felt storm evolution invalidated scoring). To their best ability, the human scorers treated 10- and 20-minute evaluations as independent (cross referencing was not used to aid interpretation). All Miss/Evolution SEPs are excluded when considering SEP motion accuracy. The Miss category contains all those situations not covered by the first two and are considered SEP motion failures.

Eleven operational days were selected for analysis, with every attempt made to obtain a uniform selection across site (Memphis vs Orlando) and with respect to average storm speed. Most storms with estimated speeds greater than 25 knots are from the Memphis data base.

First, two issues not represented in the above data set or summary analysis deserve comment.

1. During the very first days of Memphis operation, long extended line storms (not experienced in Orlando in 1993) revealed a deficiency in the sub-algorithm that generates leading-edge contours. One day quite representative of this problem was 9 June 1994 (Memphis). The algorithm was corrected for the remaining (major) portion of the DemVal, and no further gross violations were identified during the demonstration period. This technical issue can be addressed more comprehensively with future upgrades, and these initial deficiencies are not included in the statistics below.

2. The SEP algorithm implemented for DemVal did not take account of the ASR data horizon. Consequently, SEP contours were created along the data boundary, and extrapolations were shown beyond the range of the ASR. This condition was not considered serious enough to warrant correction during the DemVal. For the purpose of scoring, however, these cases were not included either because the required correction is simple and straight forward.

The validation of SEP performance consists of comparing the number of SEP contours marked as hits versus those marked as misses. The Miss/Evolution category is not considered in regard to the fulfillment of MOPR because it represents instances where the human scorer could not discern the correctness of the motion information. The statistics for growth/decay are significant in documenting the severity of growth/decay effects in the two DemVal environments.

TABLE 4 contains the sum tallies for SEP scoring. Adding the results for Memphis and Orlando, there is a 0.96 Hit rate for 10-minute extrapolation and a 0.88 rate for 20-minute extrapolation.

TABLE 4.
SEP Scoring Statistics by Location

		Hits	Miss	Miss/Evolution
10 Minutes	Memphis	0.96 (2997/3110)	0.04 (113/3110)	740
	Orlando	0.96 (2659/2759)	0.04 (100/2759)	571
	Both	0.96 (5656/5869)	0.04 (213/5869)	1311
20 Minutes	Memphis	0.85 (2474/2909)	0.15 (435/2909)	950
	Orlando	0.92 (2323/2529)	0.08 (206/2529)	801
	Both	0.88 (4797/5438)	0.12 (641/5438)	1751

TABLE 5 re-examines the same data with the counts stratified to illustrate the effects of average storm speed (average of all Storm Motion velocities for the day's operation). Clearly, the 10-minute results meet

the MOPR. For this preliminary analysis, no effort was made to further understand the nature of algorithm misses in the Miss category. Because the computed average speeds represent an average speed for the day/storm, TABLE 5 also represents a stratification by day, and it is not yet clear what effect individual storms had in biasing the summed results. A more detailed examination therefore appears warranted.

TABLE 5.
SEP Scoring Statistics by Average Storm Speed Excluding Storms Which Exhibit Growth and/or Decay

		Hits	Miss	Miss/Evolution
10 Minutes	5–10 knots	0.92 (2342/2540)	0.08 (198/2540)	414
	10–25 knots	0.97 (2420/2505)	0.03 (85/2505)	762
	>25 knots	0.96 (1001/1040)	0.04 (39/1040)	218
	All speeds	0.95 (5163/6085)	0.05 (322/6085)	1394
20 Minutes	5–10 knots	0.81 (2001/2471)	0.19 (470/2471)	483
	10–25 knots	0.97 (1958/2029)	0.03 (71/2029)	1023
	>25 knots	0.85 (838/986)	0.15 (148/986)	272
	All speeds	0.87 (4797/5486)	0.13 (689/5486)	1778

TABLE 6 presents the performance for all storms. When storms exhibiting significant growth and/or decay are included, only 77 percent of the SEP contours provide a good match to the actual precipitation leading edges. Only 66 percent of the 20-minute extrapolations are a good approximation to the actual precipitation leading edge 20 minutes in the future. Since ITWS Air Traffic need an accurate depiction of the weather situation in the future to make timely planning decisions, the performance of the 20-minute SEP clearly needs improvement if it is to be used operationally as an accurate precipitation future position prediction. This is a principle goal of the ITWS preplanned product improvement work. In addition, the limitations of the IOC SEP product need to be addressed explicitly in training for Air Traffic planners.

TABLE 6.
SEP Scoring Statistics by Average Storm Speed Including Storms Which Exhibit Growth and/or Decay.

		Hits	Miss
10 Minutes	5–10 knots	0.79 (2342/2954)	0.21 (612/2954)
	10–25 knots	0.74 (2420/3267)	0.26 (847/3267)
	>25 knots	0.80 (1001/1258)	0.20 (257/1258)
	All speeds	0.77 (5763/7479)	0.23 (1716/7479)
20 Minutes	5–10 knots	0.68 (2001/2954)	0.32 (953/2954)
	10–25 knots	0.64 (1958/3052)	0.37 (1144/3052)
	>25 knots	0.67 (838/1258)	0.33 (420/1258)
	All speeds	0.66 (4797/7264)	0.34 (2467/7264)

5. ITWS MICROBURST PRODUCTS

The ITWS Microburst algorithms are responsible for the detection and prediction of strong divergent outflows of wind near the ground surface generated from storm downdrafts. The detection and prediction portions of the product are actually separate algorithms whose outputs are combined into one set of display shapes and text messages. The purpose of this product is to enhance safety of landing and departing aircraft. The graphical alerts (shapes) are displayed on the Situation Display in the tower and TRACON. The text messages are displayed on the Ribbon Display at each tower controller position. These messages are read directly to pilots on final approach or departure. An example of the product is provided in Figure 11.

5.1 MICROBURST DETECTION ALGORITHM

The diverging outflow of cold air resulting from a strong storm downdraft can result in a rapid transition from a headwind to a tailwind for an aircraft encountering the event on takeoff or landing. The increased lift from the headwind can cause an unaware pilot to reduce speed and angle the aircraft nose downward, which accentuates the decreased lift on the tailwind side. When the microburst is strong and the aircraft is low, even an aware pilot may not be able to maintain safe flight. Most existing wind shear detection systems, such as LLWAS (Low Level Windshear Alert System) and TDWR, warn about microbursts by specifying the anticipated change in wind speed (headwind to tailwind) along the flight path. The ITWS microburst detection algorithm has been improved to take advantage of recent studies by National Aeronautics and Space Administration Langley and several manufacturers of airborne wind shear detection systems. Microburst and wind shear severity are more closely related to the **rate** of the wind speed change (shear), rather than the magnitude of the change itself. This means that a 50-knot wind speed loss over distance of 2 nm is inherently more severe than a 50-knot wind speed loss over a distance of 4 nm. The use of shear, rather than wind speed difference, results in warnings which more closely reflect the danger to the aircraft.

Each surface scan by the TDWR provides a picture of the component of the winds flowing toward or away from the radar. The ITWS microburst detection algorithm converts these Doppler velocities to a two-dimensional map of the shear along the path of the radar beams. The shear map is searched for regions of strong diverging shear (indicating winds at the surface are spreading – a key clue to microburst presence). The search is performed at several shear levels, and the areas of strong shear are analyzed for peaks to attempt to create one output shape per microburst event. The shapes are created as circles, unless the algorithm has strong evidence that the microburst event is not completely circular, in which case the TDWR-like banded shapes are output. Finally, the alerts are checked for precipitation on the ground or above the event to verify that enough moisture is present to cause a microburst. This helps remove false alarms created by other phenomena which may look like microbursts (such as a flock of birds taking off from the ground in all directions).

In previous experiments with the TDWR testing, microburst alerts equaling the maximum strength of each shape impacting the runway were output. Users testing the system remarked about overwarning of mi-

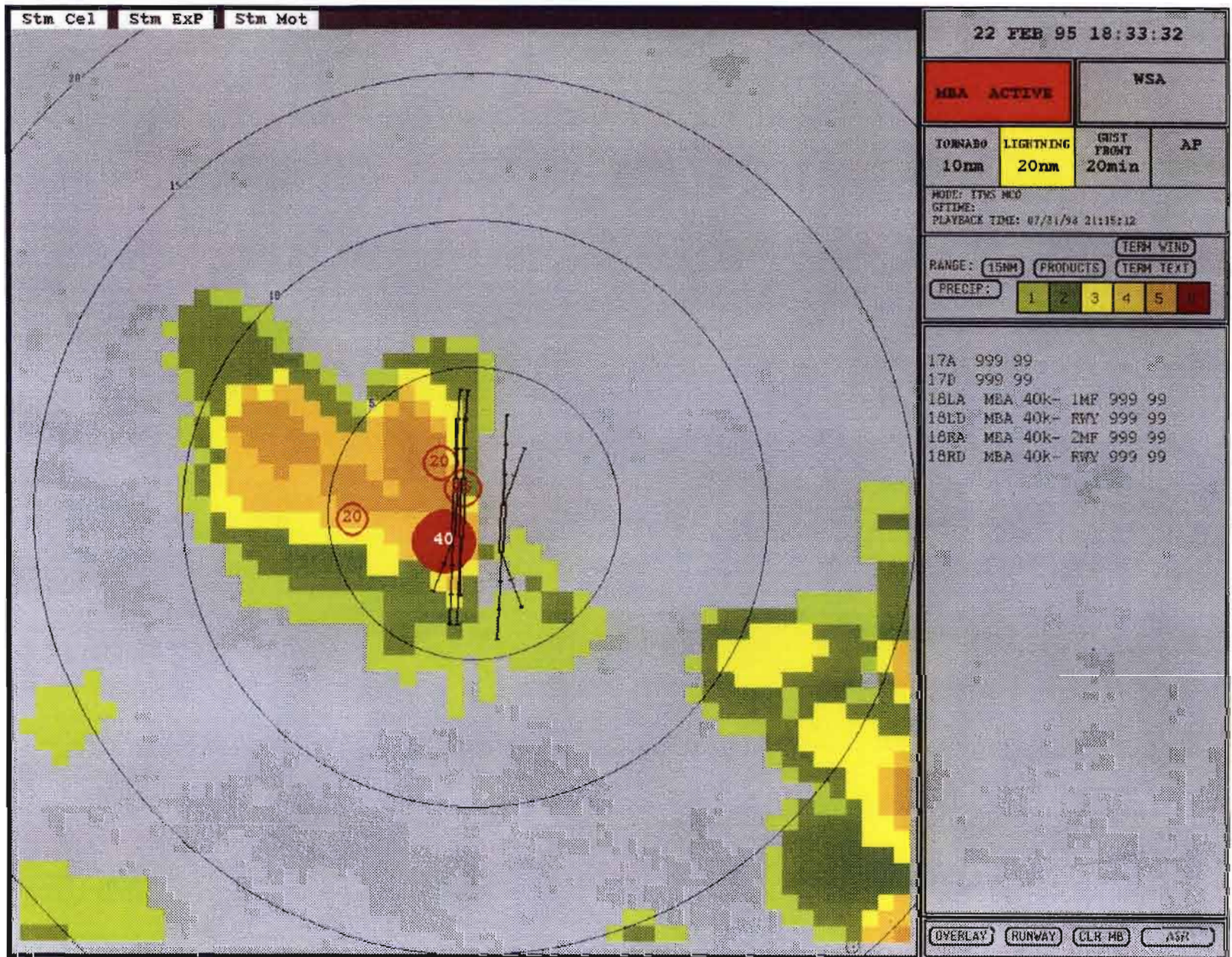

Figure 11. Example of the ITWS microburst detections on the Situation Display. The red circular regions overlaying the precipitation map indicate the presence of microbursts and wind shear events; filled shapes correspond to microbursts, hollow shapes correspond to wind shears events. The messages that would appear on the Ribbon Display are shown in the gray panel at the center right of the display.

icroburst and wind shear severities. Since that time, the microburst strength is downgraded based on the extent to which it overlaps the runway corridor. When an alert shape intersects a runway flight path, or is very close to it, the runway alert level is calculated by assuming that the strongest hazard is through the center of the event. The runway velocity change is then calculated by dividing the maximum length of the overlap of the alert with the runway corridor by diameter of the alert shape and multiplying by the maximum alert strength. This is depicted in Figure 12.

$$\text{Fractional length overlap} = \frac{1.0 \text{ nm}}{1.5 \text{ nm}}$$

$$\text{Flight path strength} = (1.0/1.5) * 40 \text{ kts} = 26.7 \text{ kts}$$

$$\text{Flight path strength} = 25 \text{ kts (rounded)}$$

Text Message:

18A WSA 25K- 1MF

(18 Approach, Wind Shear Alert, 25 knot loss at 1-mile final)

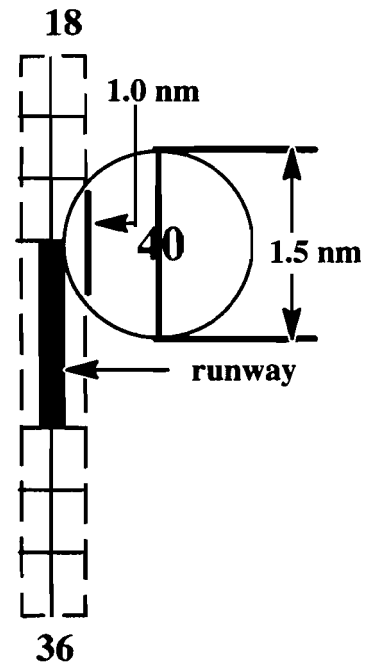

Figure 12. Strategy for the generation of a microburst alert. The diameter of the 40-knot microburst is 1.5 nm. The length of the microburst shape that lies along the approach corridor is 1 nm.

5.2 TECHNICAL PERFORMANCE ASSESSMENT AND RESULTS

Flight path truth data were generated by reviewing the TDWR data with the appropriate runway ARE-NA (area noted for attention) overlay. Doppler radar products needed to generate the truth include radial shear, radial velocity, and VIL (vertically integrated liquid water). An event is considered a wind shear or microburst

if the following criteria are met. The event must contain a continuous region of at least 4.2 km/nm (4 m/s/km) of radial shear extending several radials in azimuth and at least 0.27 nm (0.5 km) along the flight path. The maximum velocity difference (ΔV) along a radial within the event must be at least 15 knots over a distance of 1.85 nm (1 km) or less. In addition, a VIL value of at least 5 kilograms per square meter must be in close proximity (within 1 nm) of the event. Once the above criteria are met, the maximum ΔV observed within an ARENA is recorded as the strength of the truth event.

The performance of the Microburst Detection algorithm is assessed using the metrics of probability of detection (POD) and probability of false alarm (PFA). Probability of detection is defined as the number of correct detections divided by the number of true events. Probability of false alarm is defined as the number of detections not supported by truth divided by the number of algorithm alarms. These numbers are generated for both the wind shear (greater than 15 knots) and microburst (greater than 30 knots) alert levels. Performance is based on runway alerts where TDWR can substantiate the loss. Overwarning and underwarning probabilities also are computed. Overwarning occurs when microburst alerts are incorrectly issued for wind shear events. Underwarning occurs when wind shear alerts are incorrectly issued for microburst events. The scoring is performed using the contingency table approach and the tolerances discussed by Cole and Todd, 1993.

The results from the 1994 DemVal are provided in TABLE 7. These statistics are for five days in Memphis and eight days in Orlando. From these tables, the POD, PFA, and probabilities of overwarning and underwarning are computed. These performance statistics are presented in TABLE 8.

TABLE 7. Contingency Tables for Microburst Algorithm Performance.

Memphis					
	EVENT				
		Null	Wind Shear	Microburst	Total
ALERT	Null	0	8	0	8
	Wind Shear	2	163	1	166
	Microburst	0	1	11	12
	Total	2	172	12	186
Orlando					
	EVENT				
		Null	Wind Shear	Microburst	Total
ALERT	Null	0	10	0	10
	Wind Shear	20	550	6	576
	Microburst	0	23	126	149
	Total	20	583	132	735

TABLE 8.
Performance Statistics for the Microburst Detection Algorithm.

	Memphis	Orlando	Both
POD (wind shear)	0.95 (163/172)	0.94 (550/583)	0.94 (713/755)
POD (microburst)	0.92 (11/12)	0.95 (126/132)	0.95 (137/144)
PFA (wind shear)	0.01 (2/178)	0.03 (20/725)	0.02 (22/903)
PFA (microburst)	0.00 (0/178)	0.00 (0/725)	0.00 (0/903)
P(overwarn)	0.08 (1/12)	0.15 (23/149)	0.15 (24/161)
P(underwarn)	0.01 (1/166)	0.01 (6/576)	0.01 (7/742)
Wind Loss Estimates*	0.90 (158/176)	0.79 (555/703)	0.81 (713/879)

* Wind loss estimates within 5 knots or 20 percent of the actual loss.

5.3 MICROBURST PREDICTION ALGORITHM

Microburst outflows form as a thunderstorm downdraft reaches the ground and spreads out. Signs of this downdraft can be identified by the Microburst Prediction algorithm using TDWR precipitation data and temperature and humidity data from surface observations, NWS models, and commercial aircraft (temperature only). Microburst predictions provide an average lead time of two minutes for developing microburst events. This provides a “heads up” to pilots lining up for final approach or takeoff and compensates for any latency in the Microburst Detection algorithm (Wolfson, *et al.*, 1994)

For each microburst prediction, a computer process checks to see if the prediction overlaps either a wind shear alert (WSA) or a microburst alert (MBA). If no overlap occurs, a 15-knot WSA is issued. If the prediction does overlap a WSA, the WSA is upgraded to a 30-knot MBA. Finally, if a detected MBA is already present, no change is made to the display. With this concept, no new symbols are introduced on the Situation Display and, if the predictions impact the runway corridors, both the controllers and pilots will be made aware of them through the Ribbon Display. They will appear as actual WSA or MBA messages.

5.4 TECHNICAL PERFORMANCE ASSESSMENT AND RESULTS

The algorithm attempts to predict microbursts which are (a) between 2.7 and 16.2 nm from the radar, and (b) at least three degrees from the edge of the TDWR scanning sector. Within this region features aloft

can be identified and followed for developing microburst parent storms. A microburst is defined as a divergent wind loss event which attains a loss of over 30 knots. A wind shear is defined as a wind loss event which attains a loss of 15 knots. Truth consists of human-identified microburst events.

The performance metrics for microburst prediction are probability of predicting an event (POP) and probability of false prediction (PFP). POP is the likelihood that a true event will be predicted. PFP is the likelihood that an individual prediction does not match (within nine minutes) an event whose strength is greater than or equal to 15 knots.

The POP is determined by trying to match each predicted shape with the truth event most closely associated with the prediction. The association is accomplished by comparing the location of the prediction relative to the prospective matching event. The truther searches up to nine minutes forward to find matching events. A prediction can only match one microburst event. Generally a criteria of 25 percent overlap of the two regions is required, however very small alerts or predictions (less than 0.5 nm in radius) that are within 0.5 nm of the prediction are considered hits. POP is computed as the number of correctly predicted events divided by the total number of predictable events.

The PFP is calculated using the minute-by-minute predictions. All predictions that do not match an event are considered false. The PFP is computed as the number of false predictions issued by the algorithm divided by the total number of predictions issued.

The MOPR for microburst prediction are:

1. PFP (*i.e.*, actual loss less than 15 knots) of ≤ 0.10 .
2. Prediction lead time ≤ 2 minutes ± 2 minutes prior to onset of microburst for 60 percent of predicted events.

A test suite of data from the past summer consisting of 20 days from Memphis and eight days from Orlando was used to score the algorithm. The prediction algorithm has the ability to run in two modes, unrestricted and restricted. In unrestricted mode, the algorithm will issue every prediction that is made. In restricted mode, a prediction is issued only if it overlaps an existing wind shear alert made by the Microburst Detection algorithm. During DemVal the algorithm was run in restricted mode in Memphis and unrestricted mode in Orlando.

TABLE 9 shows the total statistics for each site in both unrestricted and restricted modes. The POP comfortably exceeds the MOPR at both sites in restricted and unrestricted modes. The MOPR for PFP (0.10 at 15 knots) is met in the restricted mode (0.0), but not in the unrestricted mode (0.27). The MOPR for lead time is also met. The detailed analyses are presented in APPENDIX B.

The majority of false predictions were alarms that were issued too late and actually matched microbursts that had peaked and were decreasing. Work is continuing to fix the problem of late predictions. Other

false alarms were found on days when the algorithm ran for an extended period of time (*i.e.*, overnight). Apparently, the algorithm's feedback threshold was set too low. When new weather developed the following day, false alarms resulted.

TABLE 9.
Performance Statistics for the Microburst Prediction Algorithm.

SITE	POP		PFP		AVERAGE LEAD TIME (SECS)	
	RES	UNRES	RES*	UNRES	RES	UNRES
MEMPHIS	0.80 (20/25)	0.80 (20/25)	0.00 (0/155)	0.33 (132/404)	126	246
ORLANDO	0.56 (14/25)	0.64 (16/25)	0.00 (0/118)	0.19 (63/329)	58	205
TOTAL	0.68 (34/50)	0.72 (36/50)	0.00 (0/273)	0.27 (195/733)	92	226

* RES is restricted mode; UNRES is unrestricted mode. The PFP for the restricted case at the wind shear level is 0.0 because a prediction must overlap a wind shear event to be issued.

6. ITWS GUST FRONT AND WIND SHIFT PRODUCTS

Like the current operational TDWR gust front product, the ITWS gust front and wind shift products provide air traffic controllers and supervisors with timely reports of gust front location and strength, and provides planning guidance through estimates of future gust front positions and expected wind shifts. In addition, gust fronts may contain wind shears that are potentially hazardous to landing and departing aircraft. Thus, the product also enhances safety of these aircraft. Unlike the TDWR product, the ITWS product uses state-of-the-art, knowledge-based image processing techniques to detect and track gust fronts in Doppler radar data. This technology provides more gust front detections (fewer misses), better quality detections (more of the gust front length is detected), and more consistent detections (better estimate capability) than the operational TDWRs. An example of the product is provided in Figure 13.

6.1 GUST FRONT ALGORITHM

A detailed description of the gust front detection algorithm can be found in Troxel and Delanoy (1994). Briefly, the ITWS approach to gust front detection searches radar reflectivity and Doppler velocity data for several characteristic signatures in the data that may indicate the presence of a gust front. A number of feature detectors are used; one detects thin lines in a reflectivity image, another “subtracts” the previous reflectivity image from the current one and looks for motion, and another feature detector looks for lines of convergence in the Doppler velocity map. In contrast, the TDWR gust front detection approach uses only one feature detector (convergence) to find gust fronts.

No single feature detector is a perfect discriminator in all situations; not all signatures are always present and other phenomena may mimic some gust front features (such as migrating birds and thin bands of light precipitation). However, the combined opinion of a number of feature detectors provides a much more reliable confirmation of the presence of a gust front. The ITWS approach combines the evidence from all of the feature detectors. After the evidence has been combined, a threshold is applied to extract the gust fronts.

Once the gust fronts have been detected, an attempt is made to associate each gust front with gust fronts detected in earlier images. A detection history is maintained to allow point-by-point correspondence and tracking of gust fronts. Propagation speed and direction are calculated for each associated point and are used to extrapolate the position of that point into the future to produce point-by-point flexible estimates of future gust front position. For each gust front detection, a series of estimates are generated for 1-minute intervals out to 20 minutes. For each detected front, the Doppler measurements in front of, within, and behind the front are examined to estimate the wind shear hazard and the wind shift associated with the front. LLWAS sensor data are also used where appropriate to improve gust front wind estimates in regions where Doppler measurements are ambiguous or absent (due to insufficient return signal).

6.2 TECHNICAL PERFORMANCE ASSESSMENT AND RESULTS

The Gust Front/Wind Shift products must meet or exceed a variety of operational requirements. Hence, there are a number of performance measures that are needed to quantify algorithm performance.

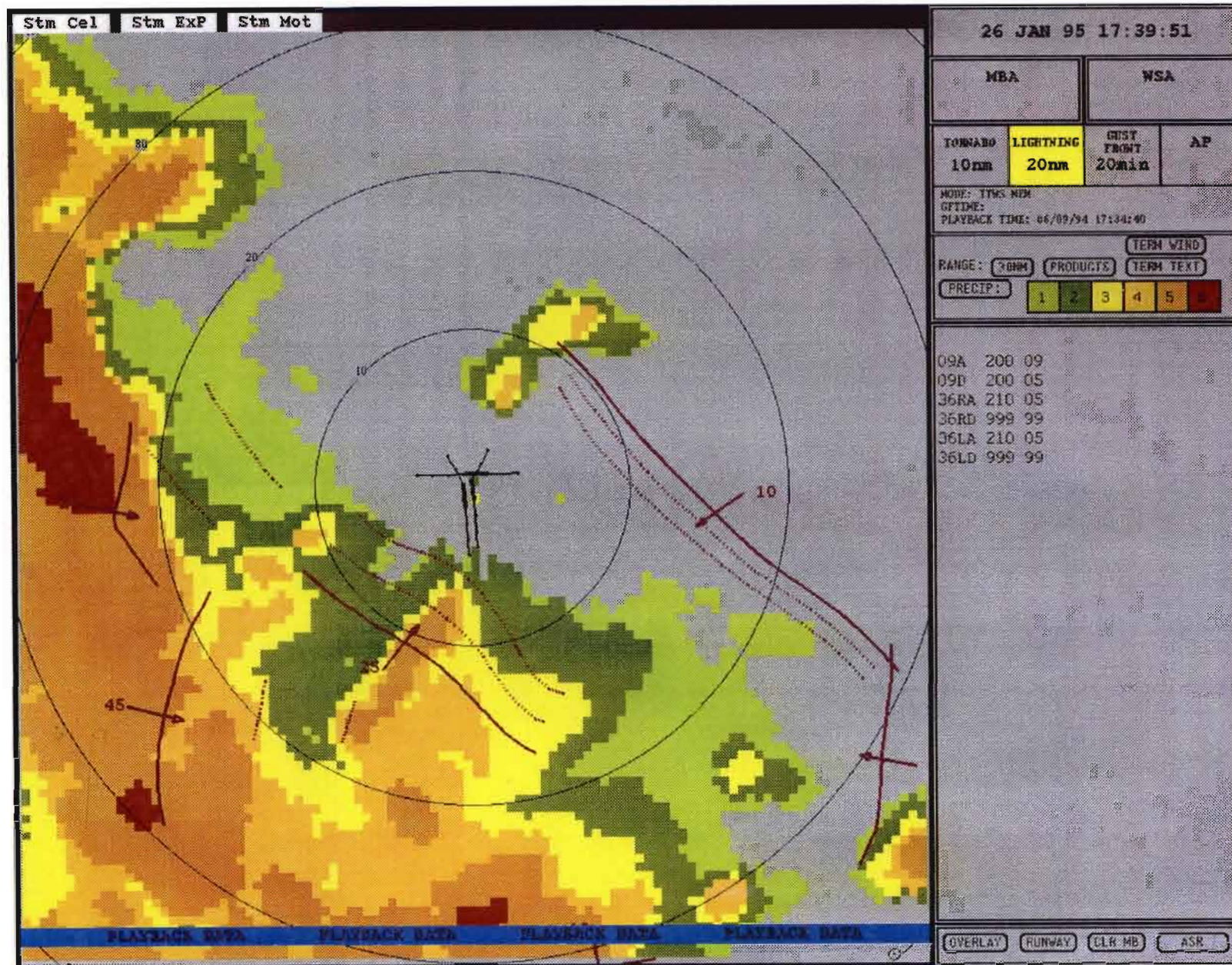

Figure 13. Example of the ITWS Gust Front Detection product. Solid purple curves indicate current gust front locations. Dashed purple curves indicate 10- and 20-minute forecast gust front positions. Numbered arrows indicate expected wind shift after frontal passage.

Gust Front Location: Two different metrics are used to assess how well the locations of gust fronts are reported by the algorithm. The first measure is a crude “hit/miss” statistic that counts a detection successful if any part of the detection overlaps a 2.7-nm wide gust front truth region identified by a human analyst. A detection is counted as false if it falls completely outside of any truth regions. An overall POD is computed by dividing the number of successfully detected fronts by the number of fronts identified by the human analyst. The PFA is the number of false detections divided by the total number of detections (both valid and false).

The second metric better quantifies detection quality by comparing the length of the front estimated by the algorithm against the total length of the region identified by the human analyst. The percent of length detected (PLD) is the length detected expressed as a percent of the length delimited by the human analyst. The percent of false length detected (PFD) reflects the fraction of total detection length that was not verified by truth.

Gust Front Location Estimates: Gust front location estimates are scored using similar metrics as for the gust front location described above. The corresponding hit/miss metrics are PFI_d (probability of generating a correct estimate, given a detection) and PFI_e (probability of generating a correct estimate, given an event), while the corresponding length-based metrics are CFP (Correct Estimate Probability) and FFP (False Estimate Probability). The scores are generated by comparing 10- and 20-minute estimate positions against the 2.7-nm wide gust front truth regions corresponding to the valid time of the given estimate.

Scoring procedures for gust front position and position estimates are described in more detail in Klinge-Wilson *et al.*, 1992.

Wind Shift: The wind shift product is currently configured to estimate the wind speed and direction that will occur 10 minutes after the gust front crosses the airport reference point (ARP). To score how well this is accomplished, an average of the wind shift speed and direction estimates (generated by the algorithm while the gust front was between 10 and 20 minutes away from the airport) is compared against centerfield LLWAS readings taken between seven and 13 minutes after gust front passage over the ARP. If the averaged wind shift speed falls within the error bounds described in TABLE 10, the wind shift estimate is considered a hit contributing to the PAWS (probability of accurate wind shift); otherwise it is a miss, contributing to the wind shift PEWS (probability of erroneous wind shift). For example, if the wind shift estimate for a strong (greater than 25 knots) gust front is within ± 10.0 knots and ± 30 degrees and if the wind shift occurs within 7 to 13 minutes after the gust front passes the ARP, then the wind shift estimate is considered a hit.

Wind Shear Estimate: The probability of generating a correct wind shear alert (PWSA) and the probability of generating a wind shear alert that is false (PWSFA) is computed by comparing algorithm wind shear hazard estimates against analyst-generated estimates of wind shear hazard obtained by examination of TDWR Doppler velocity data, from pilot reports (if available), and/or LLWAS data for gust fronts that impacted airport runways. A valid alert will be declared if the reported wind shear hazard is within five knots or 20 percent of the actual wind shear hazard, whichever is greater. A false alert is counted if the actual wind shear hazard is less than 15 knots, and the reported wind shear hazard is less than or equal to 20 knots. If the actual wind shear hazard is less than or equal to 15 knots, and the reported wind shear hazard exceeds the

five knot–20 percent rule, then a miss is declared. Such misses will reduce the PWSA, but will not be counted in the PWSFA.

TABLE 10.
Requirements for Wind Shift Estimate as a Function of Wind Shift Strength.

WIND SHIFT STRENGTH	PAWS	PEWS	WIND SHIFT ERROR	ESTIMATED TIME OF ARRIVAL ERROR
> 25 knots	70	10	± 10.0 knots, ± 30 degrees	± 3 minutes
> 15 to 25 knots	60	10	± 7.5 knots, ± 30 degrees	± 3 minutes
5 to 15 knots	50	10	± 5.0 knots, ± 30 degrees	–

Given the algorithm alert classifications described above, PWSA is computed as the number of valid algorithm wind shear alerts divided by the number of true alerts. The PWSFA is defined as the number of false wind shear alerts divided by the sum of valid and false wind shear alerts. The gust front wind shear hazard, or headwind gain along a runway corridor, must be within five knots or 20 percent (whichever is greater) of the actual gain.

The MOPR for the gust front product are:

1. Predict 70 percent of gust fronts impacting airport with wind change of greater than or equal to 15 knots 10 minutes in advance
2. Probability of false 10–minute prediction less than or equal to 0.10 for gust fronts with wind change of greater than or equal to 15 knots

Gust front truth data were generated from examination of TDWR reflectivity and velocity base data plots along with LLWAS anemometer time series plots for 18 different gust front events which occurred during a 10–hour period on 19 August 1994 at Orlando. For Memphis, truth data were generated in similar fashion for 30 gust fronts which occurred during a 14–hour period on 8 July 1994. The truth data served as inputs to an automated gust front scoring utility which provided performance statistics on detection accuracy as well as 10–minute and 20–minute estimate accuracy. Given the limited number of different days analyzed so far, detection performance results presented here should be considered preliminary.

TABLE 11 summarizes gust front detection performance for the ITWS gust front detection algorithm for the Memphis and Orlando cases. As is typical for Orlando, there were no strong or severe gust fronts on this particular day. Detection performance was excellent, both in terms of the event-based metrics and in terms of total length detected. Although several gust fronts with strong and severe strengths were observed during the summer, the gust fronts analyzed for the July 08 case were all weak or moderate strength. Detection probabilities fell slightly for the Memphis case, which had an overall POD of 0.89. In Memphis, there were more gust fronts embedded within storm cells. With embedded fronts, the only evidence is the velocity convergence signature (no distinct reflectivity thin line), and as a result, detections of some of the weaker events were sometimes delayed as the algorithm required additional “looks” at the event to build sufficient confidence before reporting the gust front.

TABLE 11.
Gust Front Detection Performance for the ITWS Gust Front Detection Algorithm

Strength	POD	PFA	PLD	PFD
Memphis				
Weak	0.88	–	0.81	–
Moderate	1.00	–	0.98	–
Strong	–	–	–	–
Severe	–	–	–	–
All Memphis	0.89	0.06	0.82	0.24
Orlando				
Weak	0.94	–	0.85	–
Moderate	1.00	–	0.85	–
Strong	–	–	–	–
Severe	–	–	–	–
All Orlando	0.95	0.05	0.85	0.12

False alarms at both locations tended to be sporadic and short-lived. Most were dropped after a single algorithm processing interval (five minutes). Primary causes of false detections were noisy data, alerting on

radar features that were weak (*e.g.* weak convergence, limited motion, length less than 0.5 nm), and inappropriate “coasting” of detections after the event had dissipated.

TABLE 12 lists PFId results for Memphis and Orlando. The results show that in general, position estimates were reliably generated once a detection had been issued. More than 80 percent of the 10-minute position estimates for all gust front detected in Memphis and Orlando were validated. As expected, performance for 20-minute estimates decreased, especially at Memphis, due to the increased likelihood of changes in gust front propagation or strength over the longer estimation period (the Memphis gust fronts exhibited stronger variability over time due to more vigorous storm dynamics, making estimates more challenging for that site).

TABLE 12.
PFId Results for the ITWS Gust Front Detection Algorithm.

	Weak	Moderate	Strong	Severe	All	False
Memphis (10-min)	0.80	1.00	–	–	0.81	0.15
Memphis (20-min)	0.68	0.91	–	–	0.69	0.28
Orlando (10-min)	0.88	1.00	–	–	0.89	0.07
Orlando (20-min)	0.81	0.57	–	–	0.80	0.22

Overall false estimate probabilities were respectable, but are slightly higher than desired for the Memphis 10-minute estimates. Additional investigation into the causes of false estimates (at both sites) revealed that a substantial fraction of the false estimates were associated with weaker fronts that are often short-lived and may dissipate even before the 10-minute estimation period has elapsed. Moreover, the MOPR for gust front position estimates calls for correct 10-minute advance predictions of 70 percent or more of gust fronts impacting the airport with a wind change equaling or exceeding 15 knots, with a probability of false prediction for the same fronts not to exceed 0.1.

To better determine how well the MOPR was met for the position estimates, a second evaluation was conducted with weaker gust front detections (wind shift strength less than 15 knots) excluded from the data set. However, since most Orlando gust fronts tend to be weaker than the 15 knot threshold, this resulted in only 16 individual detections remaining from the 1994 data set for evaluation. Because of the limited number of non-weak Orlando gust fronts evaluated, results for the Orlando 1994 tests are inconclusive. Since data were available from similar real-time tests conducted in 1993 in Orlando, combined results for the 1993 and

1994 operations are shown in TABLE 13. This combined data set provided over 300 individual detections with which to perform the evaluation. The 10-minute estimates of gust fronts with significant shear at Memphis and/or Orlando met the MOPR.

TABLE 13.
PFId Results for the ITWS Gust Front Detection Algorithm.
(Wind Shift Strength \geq 15 knots)

Location	Correct	False
10-minute Estimates		
Memphis	0.95	0.05
Orlando (93 and 94)	0.83	0.09
20-minute Estimates		
Memphis	0.90	0.12
Orlando (93 and 94)	0.72	0.22

Position estimate performance for all gust front strengths was also assessed independent of detection performance. PFle are shown for Memphis and Orlando gust fronts in TABLE 14. In Memphis, accurate 10-minute estimates were generated for 73 percent of the gust fronts that occurred, while 83 percent of the Orlando gust fronts were accompanied by accurate 10-minute estimates. Compared to 10-minute estimates, PFle values for the 20-minute estimates fell by less than 10 percent at each of the two sites. As expected, the number of false 20-minute estimates was higher in Memphis than in Orlando due, once again, to the more vigorous storm dynamics at Memphis.

TABLE 15 presents corresponding length-based statistics (CFP, FFP) for 10-minute and 20-minute estimates. The length-based statistics echo the trends seen and discussed for the event-based statistics in TABLE 14.

TABLE 14.
PFle Results for 10-minute and 20-minute Estimates.

	Weak	Moderate	Strong	Severe	All	False
Memphis (10-min)	0.70	0.92	–	–	0.73	0.17
Memphis (20-min)	0.62	0.76	–	–	0.64	0.30
Orlando (10-min)	0.82	1.00	–	–	0.83	0.11
Orlando (20-min)	0.76	0.44	–	–	0.74	0.17

TABLE 15.
CFP Results for 10-minute and 20-minute Estimates.

	Weak	Moderate	Strong	Severe	All	FFP
Memphis (10-min)	0.53	0.93	–	–	0.56	0.43
Memphis (20-min)	0.37	0.76	–	–	0.40	0.58
Orlando (10-min)	0.73	0.72	–	–	0.73	0.21
Orlando (20-min)	0.62	0.42	–	–	0.61	0.32

Wind shift estimates and wind shear hazard reports were compared against LLWAS centerfield anemometer data for 18 gust fronts that were tracked across the Memphis airport during June and July of 1994. Performance statistics were computed using the performance measures described previously. Truth and algorithm data values were rounded to the nearest five knots for wind shift speed and wind shear reports, and to the nearest 10 degrees for the wind shift direction. Results presented here should be considered preliminary given the limited number of events examined to date. APPENDIX C lists the wind shift and wind shear estimates used in this analysis.

Wind shear hazard estimates produced by MIGFA met requirements for all 18 of the gust fronts examined, resulting in a PWSA of 1.0 (18/18) and PWSFA of 0.0 (0/18). Performance results for the wind shift estimate as a function of observed wind shift strength are presented in TABLE 16. Note that for the wind shift

PEWS, a “false alarm” does not mean that a wind shift estimate should not have been made, only that its reported value was declared to be inaccurate.

TABLE 16.
Gust Front Wind Shift Accuracy (Direction Error Tolerance Equals 30 Degrees).

STRENGTH CATEGORY	PAWS	PEWS
< 5 knots	1.00 (1/1)	0.00 (0/1)
> 5 to 15 knots	0.60 (9/15)	0.40 (6/15)
> 15 to 25 knots	1.00 (1/1)	0.00 (0/1)
> 25 knots	1.00 (1/1)	0.00 (0/1)
ALL	0.67 (12/18)	0.33 (6/18)

With the exception of the five to 15 knot category, MIGFA appears to meet the desired operational requirements, albeit with only one gust front comparison in each of the other categories. MIGFA appears to fall short of the requirements for PEWS in the five to 15 knot category, which also contained the largest number of fronts (15). Circumstances surrounding the six inaccurate wind shift estimates are summarized in TABLE 17.

Our limited data set included a number of complex scenarios including gust fronts accompanied by high frequency wind oscillations from gravity wave phenomena, and gust fronts exhibiting rapid development and decay. In addition, there are at least two cases where the TDWR and LLWAS reported large differences in observed (truth) wind directions, so there is disagreement even between sensors observing the same phenomenon (MIGFA relies mostly on TDWR data for wind shift estimates).

Another complicating factor in the wind shift analysis is the effect of timing (ETA) errors on the accuracy of the wind shift estimate. Most gust front wind shifts occur over a transitional period of up to several minutes, with winds gradually veering and strengthening. In addition, some gust fronts do not generate persistent wind shifts. Over the time period of interest, the winds behind the front may not settle on a particular wind speed or direction, making estimates difficult to verify as it is not clear exactly when the “shift” has been completed. As a result, comparisons of “truth” against algorithm estimates can be significantly altered by relatively small changes in location and times over which the truth and algorithm report samples are selected.

In the future, a more thorough examination of the issue of timing errors and their effects on wind shift estimate is planned.

TABLE 17.
Summary of MIGFA Wind Shift Estimate Problems

Date	Time (GMT)	Comment
06/07/94	0523	Poor radar viewing angle led to poor direction estimate.
06/16/94	2123	Bad direction estimate (good speed estimate).
06/28/94	1420	Gust front weakened rapidly after estimate.
07/01/94	0244	Variable winds due to gravity wave phenomenon.
07/05/94	1959	LLWAS direction differed by 130 degrees (LLWAS disagrees with TDWR observation by 140 degrees). Also, wind speed = 5 knots, so winds were light and variable even after gust front passage.
07/08/94	2148	LLWAS direction differed by 40 degrees. However, good agreement with TDWR (only 10 degrees difference).

Overall performance of the gust front/wind shift algorithm appears to be very good. MOPR were met or exceeded. The higher-than-acceptable false alarm rate for the wind shift estimates in the five to 15 knot strength category does not meet the stated goal. The wind direction component of the wind shift vector was found to be the most significant contributor to the errors and these errors were often associated with events that were complex in nature. The present data set for this part of the evaluation is quite limited (Memphis only) and contains a number of complex cases. Additional cases, including some from Orlando, should be examined to more thoroughly assess wind shift estimate performance.

Based on the results presented here, as well as anecdotal evidence gathered during the course of operations last summer, Memphis proved to be a more challenging environment for gust front detection than Orlando. This was expected since the majority of Orlando gust fronts originate from isolated air mass thunderstorms, and they usually propagate into clear air away from the generating storm soon after formation. As a result, the Orlando fronts are often accompanied by reflectivity thin lines as well as velocity convergence, making detection, tracking, and prediction easier. By contrast, several of the Memphis gust front events were associated with more vigorous weather, including squall lines and synoptic-scale frontal

passages. Many of the Memphis gust fronts were embedded in precipitation and the associated gust front characteristics (strength, propagation velocity, longevity) were less stable. MIGFA's gust front position estimation capability was found to be impacted by these phenomenological instabilities, especially the 20-minute estimate capability.

7. ITWS TERMINAL WINDS PRODUCT

The ITWS Terminal Winds product provides frequently updated (every five minutes) estimates of the horizontal wind at various altitudes for points of interest to ATC users (for example, at the arrival and departure gates and at turn-on to final approach). During the 1994 demonstration, the terminal winds product may be used by ATC users for traffic management and situational awareness. For the initial ITWS deployment, the Terminal Winds information will be used also by the Terminal Air Traffic Control Automation system and the ITWS gust front detection. Future applications for this information include the ITWS Ceiling & Visibility prediction, Runway Winds prediction, Thunderstorm Growth and Decay, and Wake Vortex Advisory systems. An example of the Terminal Winds product is provided in Figure 14.

7.1 TERMINAL WINDS ESTIMATION ALGORITHM

Currently, wind estimates are produced for two grids. The first grid has a horizontal resolution of about 5 nm and a vertical resolution of about 1500 feet near the surface, increasing with altitude to about 3,700 feet at 30,000 feet. This product is generated for a 135 nm x 135 nm region centered on the ARP, extending vertically to about 53,000 feet and is updated every 30 minutes. Figure 15 shows the analysis regions and sensor locations for the Orlando International Airport in 1992, when a slightly smaller 5 nm grid was used. The primary sources of data for the first grid are the Meteorological Data Collection and Recording System (MDCRS) reports from commercial aircraft arriving and departing the airport and the Aviation Gridded Forecast System (AGFS), a weather forecast model. (The AGFS is produced operationally by the NWS National Meteorological Center as the Rapid Update Cycle product. For the DemVal, the prototype AGFS produced by the National Oceanic and Aeronautic Administration Forecast Systems Laboratory was used.

The second grid is nested in the first. It has a horizontal resolution of 1 nm and the same vertical resolution. The second grid covers a 65 nm x 65 nm region centered on the ARP, extends vertically to about 18,000 ft and is updated every five minutes. The primary sources of data for the 1 nm product are the Doppler data provided by the TDWR and NEXRAD weather radars and the 5 nm resolution analysis.

The full set of data sources used to compute wind estimates for the Terminal Winds product are:

1. AGFS – a national scale weather forecast model with a 32 nm horizontal resolution and 3 hr update rate.
2. TDWR Doppler radar – single (radial) velocity component measurements with a 480 ft horizontal resolution and a five minute update rate.
3. NEXRAD Doppler radar – single (radial) velocity component measurements with a 800 ft horizontal resolution and a six minute update rate.

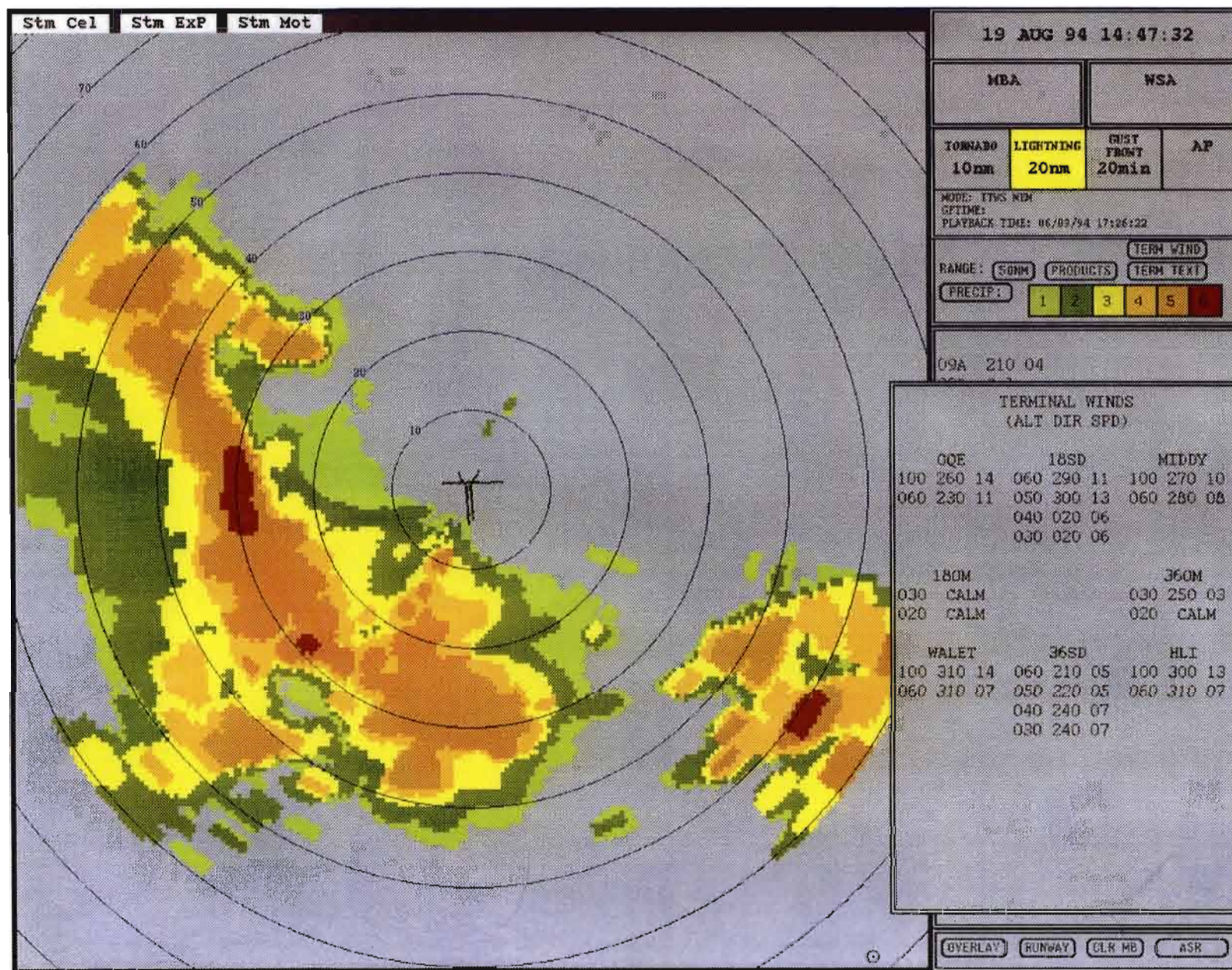

Figure 14. Example of the Terminal Winds product. The table in the lower left corner of the Situation Display provides winds at various user-selected locations and user-selected altitudes. Altitudes are in (x 100) feet above mean sea level, wind direction is in degrees rounded to the nearest 10 degrees and wind speed is in knots.

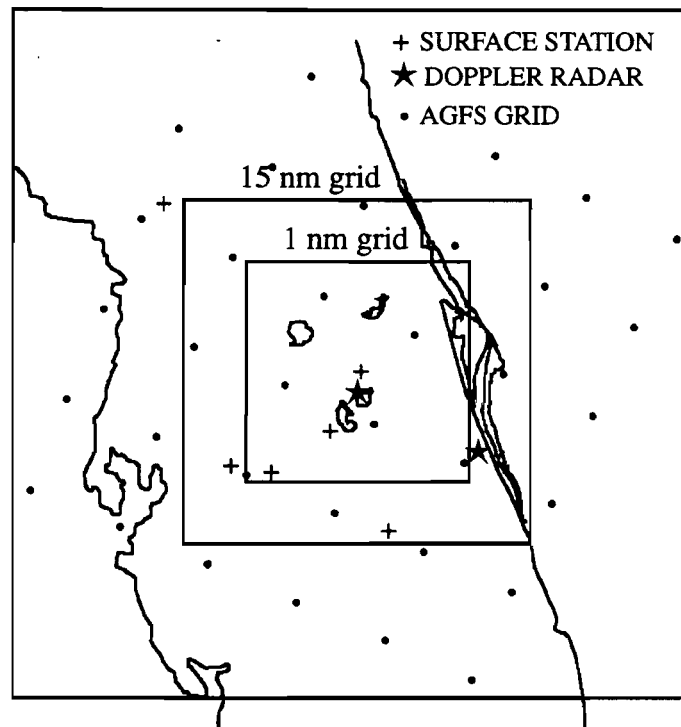

Figure 15. 1992 Orlando Terminal Winds domains and sensor locations.

4. MDCRS Aircraft measurements – vector measurements of the horizontal wind taken at random points and times along flight paths, with a data latency of at least 15 minutes.
5. LLWAS – six to 20 vector measurements at the airport surface with a 1 to 1.5 nm horizontal resolution and a 10 second update rate.
6. Automated Surface Observing Stations – widely spaced vector measurements at the surface with rapid update rate.

The Doppler radars provide accurate and dense measurements in regions with enough reflectors (for example, bugs and dust) for the radars to gather returns. This limits the vertical extent of dense Doppler data on most days to 7,000 ft or less in the summer. In the dry clear air of the winter, the vertical extent of good Doppler return will be even lower. Doppler radars are also limited to measuring only the component of the wind either towards or away from the radar. That is, if the radar is looking due north and the wind is from the west, the radar will measure the north component of the wind, which is zero. The radar correctly measures

the north component but does not provide information, at that point, on the west component. The west component must be derived from other data sources, including other Doppler radars, anemometers, and/or MDCRS.

The ITWS Terminal Winds receives data from a numbers of sources which provide information of differing content, update rate, and quality. The analysis must properly assemble this data to provide accurate estimates of the wind at each point of the analysis grid. This is done in a two step cascade-of-scales process. At each step, finer resolution wind estimates are computed using a least squares statistical technique to minimize the errors in the final wind estimates. Figure 16 shows the data flow for this process.

The first step in the cascade-of-scales is to compute the 5 nm resolution product. The AGFS wind forecasts are interpolated to the 5 nm grid and then refined using all of the available data. This is done every 30 minutes.

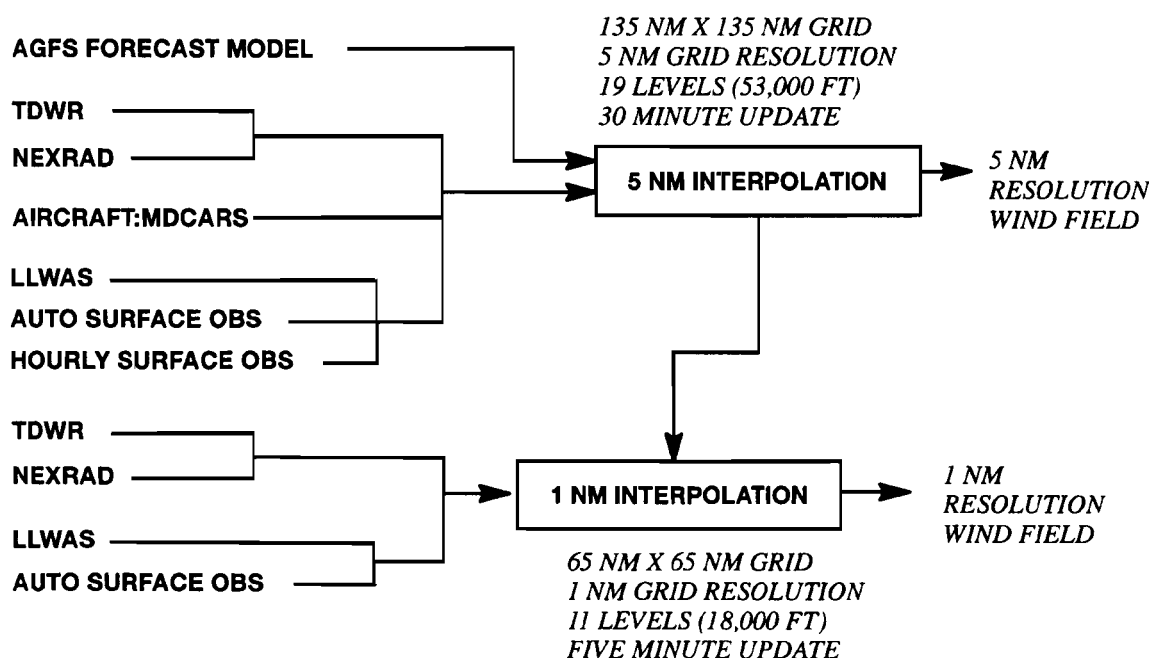

Figure 16. Data flow for Terminal Winds.

The second step is to compute the 1 nm resolution product. In this step, the current 5 nm product is interpolated to the 1 nm grid and then refined using only the rapid update data (that is, Doppler data and automated surface observations) every five minutes.

7.2 TECHNICAL PERFORMANCE ASSESSMENT AND RESULTS

The Terminal Winds analysis produces a three dimensional grid of horizontal wind vectors for a region covering the terminal area. The accuracy of these wind vectors is evaluated by comparing them with observations of the wind in the terminal area. These observations are obtained from two sources. One source is a dual-Doppler analysis of TDWR and NEXRAD data, and other is MDCRS. Each observation is matched with the analysis vector having the same time and grid coordinates. These matched pairs of vectors are compiled into two data bases; one for dual-Doppler truth and one for MDCRS truth. These databases are analyzed using the SAS data analysis system. The products of this analysis are a set of statistics and histograms characterizing the differences between the observations and analysis vectors. The standard evaluation consists of statistics on the norm of the vector difference between the observations and analysis, and histograms showing the the distributions of norm or the vector difference, U component difference, V component difference, speed difference, and direction difference.

The MOPR for the Terminal Winds product are:

1. horizontal resolution: 5 nm within 30 nm beyond the TRACON boundary and below 23,000 ft
2. vertical resolution: 50 millibars
3. ± 10 knots 80% of time in regions and at times when both TDWR and NEXRAD have valid velocity data

During DemVal, the 1-nm resolution product was created. This product exceeds the MOPR for horizontal and meets the MOPR for vertical resolution.

The results of the evaluation of the terminal winds algorithm are provided in TABLE 18. The table contains the statistics on the norm of the vector difference between dual-Doppler and each algorithm. The columns Q75 and Q25 represent the 75th and 25th quartiles, respectively. There were so few MDCRS data in Memphis that they can not support a meaningful estimate of algorithm performance.

The results of the comparison to dual-Doppler over 10 days show that the Terminal Winds product 1) has vector errors less than 2 knots 75 percent of the time in regions that have data from both TDWR and NEXRAD, and 2) does not degrade the forecasts from AGFS. The number of available MDCRS reports over the 10 days was only 64. The comparison of wind fields to MDCRS shows a greater agreement to Terminal Winds than AGFS forecasts, but the aircraft reports were too few in number to accurately quantify performance.

TABLE 18.
Performance Statistics for the Terminal Winds Algorithm.

Analysis Grid	Mean	Variance	Q80	Median	Q25	RMS-Error
AGFS	3.4	4.2	4.7	3.1	2.0	3.9
5 NM	1.4	1.9	2.0	1.0	0.6	2.0
1 NM	0.6	0.4	1.0	0.5	0.3	0.9

8. ITWS AIRPORT LIGHTNING PRODUCT

The ITWS Airport Lightning product provides an indication that lightning has been detected near a user-specified location. An example of the product is provided in Figure 17. The presence of lightning is indicated by the alert panel in the upper right corner of the display. This product may be used by ATC users to determine when to switch to back-up generator power and by airline users to help in making decisions with respect to refueling and other ground operations.

8.1 LIGHTNING WARNING PANEL ALGORITHM

The National Lightning Detection Network (NLDN) provides the raw data that are used by the lightning processor. These raw data reports give the time, location and strength of lightning strikes (primarily cloud-to-ground lightning). These data are quality-edited by comparing the reported location of the lightning strike with an ASR-9 weather channel image collected at the same time. Reported locations are accepted or rejected depending on their proximity to any weather observed on the radar image.

The lightning warning panel in the upper right corner of the Situation Display is illuminated whenever lightning is detected within a user-specified distance of a user-specified reference location. Generally, the reference location is taken to be the ARP and the distance is either 5 nm for ATC users or 20 nm for airline companies. The specification of a reference location and distance defines a circular region called the Critical Region. The warning panel is illuminated when any edited lightning strike report is detected within this Critical Region and it will remain illuminated for five minutes after the last detection in the Critical Region.

8.2 TECHNICAL PERFORMANCE ASSESSMENT AND RESULTS

The measures of performance are product availability (the fraction of the time that the lightning data is available), latency of the lightning warning panel (amount of time between the receipt of a lightning event and its transmission to the warning panel), and meteorological consistency (the degree of association of lightning and precipitation).

Product Availability: The number of status messages received per hour and the status messages themselves indicate the amount of data loss. System logs reveal that the lightning data were available to the end-user 99.2 percent of the time.

Latency of the Lightning Warning Panel: More than 99 percent of all lightning reports arrived at the input to the ITWS lightning processor within 15 seconds of occurrence. These data were then collected into 25 second intervals and sent to the display. Therefore, the maximum latency of the warning panel was about 40 seconds.

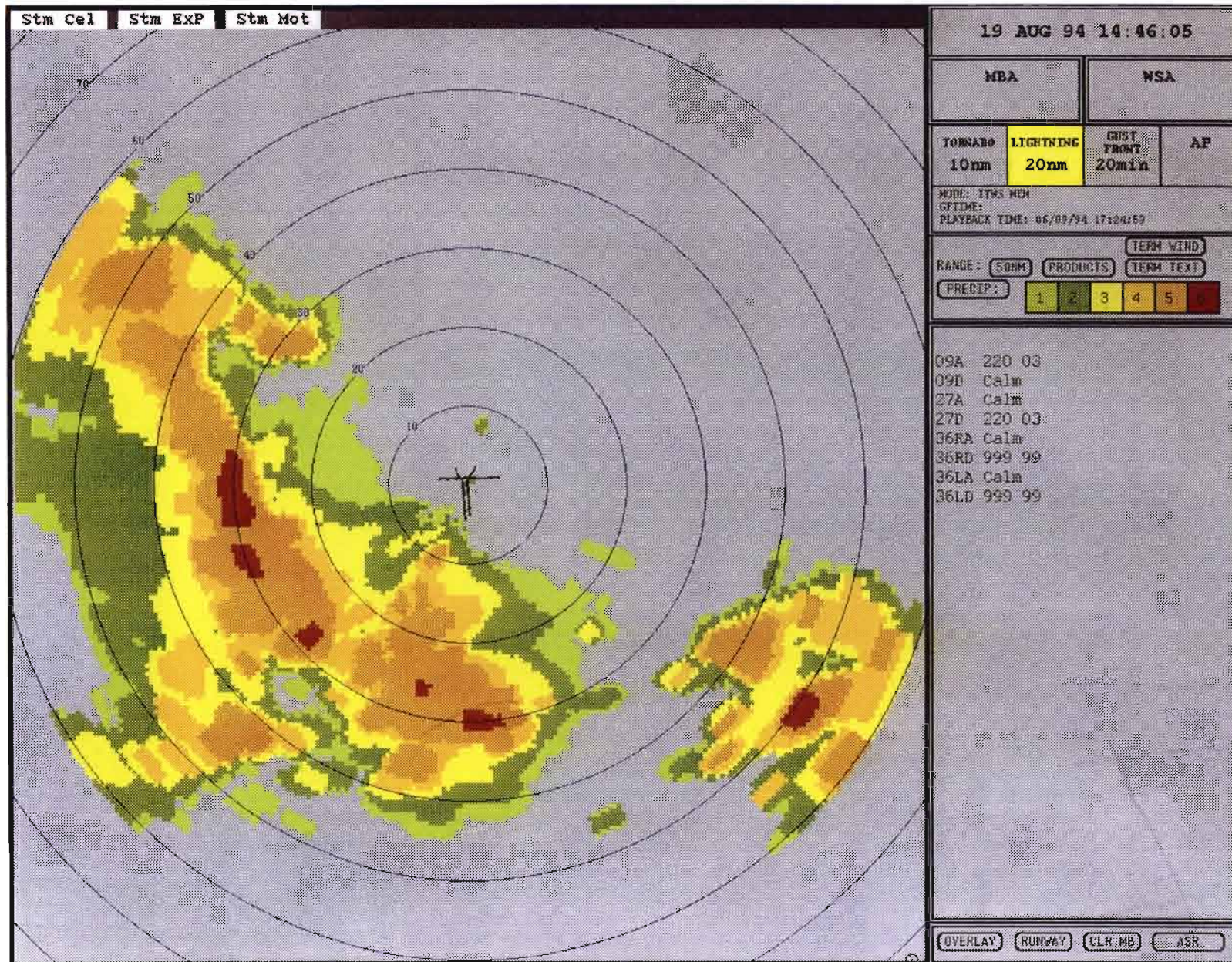

Figure 17. Example of the Lightning Detection product. The yellow box in the upper right corner is illuminated when cloud-to-ground lightning is detected within a user-specified distance (20 nm for ATC users; 5 nm for other users) of the airport reference point.

Accuracy of NLDN: Two studies of the performance of the NLDN were performed; one in 1992 in Orlando and another in 1994 in Albuquerque, NM. The locational accuracy of the NLDN was ascertained by comparing the reported locations of lightning strikes with the locations provided by the three-dimensional, total lightning mapping system operated by the French Office Nationale D'Etudes et de Recherches Aero-spatiales (ONERA). These comparisons indicate that the root-mean-square separation between the locations was 4 nm in Orlando and 4.6 nm in Albuquerque.

The overlays of lightning and ASR-9 weather reveal the percentage of lightning reports that can be considered erroneously decoded. A false alarm was declared if the reported position of the lightning was more than 11 nm from any ASR-9 observed weather level 1 or greater. Less than 0.1 percent of the lightning reports were rejected as false alarms during the Memphis DemVal.

NLDN saw 70 percent of all cloud-to-ground strokes detected by the ONERA-3D total lightning mapper. The detection efficient rose to 80 percent when considering just the strongest 50 percent of the cloud-to-ground strokes detected.

9. TERMINAL WEATHER TEXT MESSAGE PRODUCT

The Terminal Weather Text Message product shows ATC users the messages that are being delivered directly to aircraft via ACARS data link. An important goal of the ITWS program is to improve pilot situational awareness while decreasing the controller workload involved in providing weather information to pilots. As part of this effort, text-based Terminal Weather messages will be provided directly to aircraft via the ACARS data link. These Terminal Weather messages provide a summary of the weather conditions around the airport based on the ITWS products displayed on the Situation Display. This product allows ATC users to monitor the ITWS Terminal Weather messages being delivered to aircraft for shared situational awareness. An example of the product is provided in Figure 18.

9.1 PRODUCT GENERATION

The Terminal Weather Text Message Product is generated from ITWS products used for display on the Situation Display. The Storm Cell Information product is used to locate storms within the terminal area. The Storm Motion product is used to report the general motion of all storms within the terminal area. The runway impact product is used to generate the microburst and gust front information. Finally, the ITWS Precipitation product is used to generate the precipitation impacts at the airport.

The text of the Text Message product is divided into three sections; Airport Impacts, Terminal Weather, and Expected Airport Weather. The Airport Impacts section is indicated by an asterisk (*) and lists the worst weather affecting any of the operational runways. For example:

```
*MODERATE PRECIP  
BEGAN 2054
```

If a microburst is impacting one runway while heavy precipitation is impacting another runway, the text message product will issue information about the microburst (the most hazardous weather impacting the airport). The message would look like:

```
*MICROBURST ALERTS  
30 KT LOSS  
BEGAN 2105
```

The Terminal Weather section is indicated by a dash (–) and identifies the three closest storms to the airport. For each storm, the text message lists the minimum distance in nautical miles from the ARP to the weather, the direction of the storm from ARP, the storm intensity based on the highest weather level in the storm (MOD for level 2, HVY for level 3 and greater), and HAIL (if present). The last line in this section states the average motion of all storms in the TRACON. An example of the Terminal Weather message is:

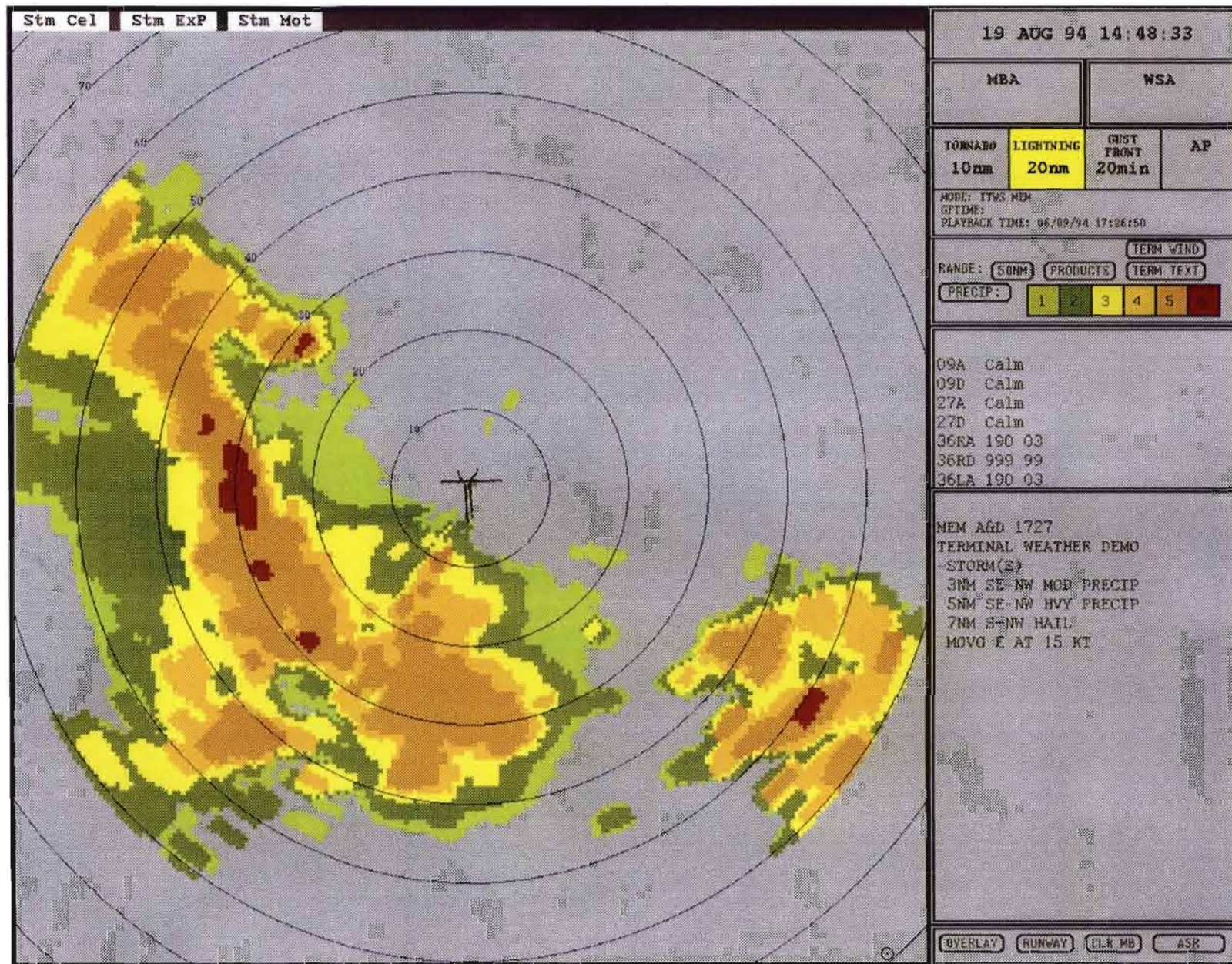

Figure 18. Example of the Text Message product. The text shown at the middle right of the Situation Display provides ATC users with the same messages that are being delivered directly to pilots via ACARS data link.

-STORM(S)	
APRT MOD PRECIP	(moderate precipitation at airport)
1NM W HVY PRECIP	(heavy precipitation 1 nm west of ARP)
17NM N MOD PRECIP	(moderate precipitation 17 nm north of ARP)
MOVG E AT 9 KT	(moving east at nine knots)

The Expected Airport Weather section is indicated by a dot (.) and reports any expected precipitation that will impact the operational runways. This section uses the ITWS Precipitation product and the average motion of all storms to estimate the time at which the precipitation will begin on a runway. The message will list the worst weather expected on the runways. For example, if moderate precipitation is expected on one runway and heavy precipitation is expected on another runway, the message will provide the information relative to the heavy precipitation. This section does not currently attempt to predict wind shear or microburst activity. An example of a message in the Expected Airport Weather section is:

```
.EXPECTED MOD PRECIP
BEGIN 2055
```

If no weather is found within 20 nm of the ARP, the text message is:

```
.NO STORMS WITHIN 20NM
```

9.2 TECHNICAL PERFORMANCE ASSESSMENT AND RESULTS

The precipitation impact messages are used as truth. An event is defined as level 2 or greater precipitation impacting at least one arena for at least five minutes. An event is correctly predicted if the event is preceded by at least one prediction in the 15 minutes prior to the onset of the event. The POP is defined as the number of correct predictions divided by the number of events. A false alarm is a prediction of an event that does not verify (*i.e.*, precipitation does not impact an arena). The PFP is the number of false alarms divided by the total number of predictions.

For each event, it is verified automatically that an expected precipitation message (*i.e.*, a prediction) occurred at least 15 minutes prior to the onset of the event. For each event, the predicted onset time is scored by comparing the actual onset time to the forecast five minutes prior to the event.

To score predictions, the 15-minute period following the prediction is searched. If no event occurs within the 15 minutes after the prediction, the prediction is false. If an event occurs within the 15 minutes after the prediction, the prediction is correct.

The performance of the Terminal Weather Text Message was assessed for the Memphis environment for the DemVal (TABLE 19). The POP was 0.96 and the PFP was 0.33 for moderate precipitation. For heavy precipitation the POP was 0.71 and the PFP was 0.32

TABLE 19.
Performance of the Terminal Weather Text Message Precipitation Predictions.

	POP	PFP
Memphis		
Moderate Precip	0.96 (24/25)	0.33 (96/289)
Heavy Precip	0.71 (12/17)	0.32 (46/142)
All Memphis	0.86(36/42)	0.33 (142/431)
Orlando		
Moderate Precip	0.92 (22/24)	0.41 (100/245)
Heavy Precip	0.83 (10/12)	0.30 (27/91)
All Orlando	0.89 (32/36)	0.38 (127/336)
Both Locations		
Moderate Precip	0.94 (46/49)	0.37 (196/534)
Heavy Precip	0.76 (22/29)	0.31 (73/233)
All	0.87 (68/78)	0.35 (269/767)

The performance of the Terminal Weather Text Message was assessed for the Orlando environment for the DemVal. For moderate precipitation events, the POP was 0.92 and the PFP was 0.41. For heavy precipitation, the POP and PFP were 0.83 and 0.30, respectively. The combined Memphis–Orlando performance for both precipitation intensities was a POP of 0.87 and a PFP of 0.37.

The results of the Memphis demonstration show that the expected precipitation algorithm works well in an environment with fast moving storms that do not grow or decay rapidly. The 10–knot storm motion threshold eliminated many potential false alarms without severely impacting the POP performance.

In Orlando, the causes of the Expected Moderate Precipitation false alarms are two–fold: storm motion and storm decay. The Storm Motion algorithm ran only on heavy precipitation (VIP level 3 or greater) and consequently did not always represent the motion of moderate (VIP level 2) precipitation. It is recommended that the Storm Motion algorithm be run on level 2 precipitation. The Expected Moderate Precipitation message could then be generated based on the level 2 storm motion.

In addition, because storm decay information was not available, the storms sometimes dissipated before reaching the airport. In an environment such as Orlando, attempting to predict slow moving storms that grow and dissipate rapidly is difficult. Without the ability to predict storm growth and decay, the performance of the expected precipitation algorithm will be degraded. Training materials need to emphasize that "expected precipitation" is a simple extrapolation of the current weather and does not account for storm evolution.

10. CONCLUSIONS

This report provided an algorithm-by-algorithm performance assessment. For each product, objective performance criteria were defined. The minimum performance requirements that a product must meet to be accepted by the ATC user community are the MOPR, given in TABLE 1. These are the requirements by which the products are judged acceptable for inclusion into IOC ITWS.

Truth data sets were created for each product. In general, these data are generated by human experts and stored in machine-readable format to support automated scoring. Thus, as future refinements and enhancements are made to the algorithms, their performance can rapidly be assessed.

The performance assessment provided herein has shown that:

1. All of the products for which MOPR are stated met or exceeded those requirements, including ITWS Precipitation (AP-edit), Storm Cell Information, Storm Motion and Storm Extrapolated Position, Microburst Prediction, Gust Front Forecast, and Terminal Winds.
2. There are no MOPR listed for the Lightning product. However, the lightning data were available to the end-user 99.2 percent of the time, the maximum latency of the warning panel was about 40 seconds, and less than 0.1 percent of the lightning reports were more than 11 nm from any ASR-9 observed weather level 1 or greater.
3. There are no MOPR listed for the Terminal Text Message product. The performance for both moderate and heavy precipitation was a POP of 0.87 and a PFP of 0.37. Analysis indicates that the expected precipitation algorithm works well in an environment with fast moving storms that do not grow or decay rapidly. The 10-knot storm motion threshold eliminated many potential false alarms without severely impacting the POP performance.
4. Training for operational users (*e.g.*, Air Traffic, pilots, airline dispatchers) will need to address performance strengths and weaknesses of each product. This was identified particularly with respect to the SEP and Terminal Text as “predictors” of future precipitation location.
5. The results provided herein indicate areas where the performance of the products can be improved relative to the performance goals shown in TABLE 1:

ITWS Precipitation (AP-edit) has exceeded the PEAP goal. The performance of the products relative to the PEW goal has yet to be determined.

Storm Cell Information is within a few percent of meeting its goal for feature association.

Microburst Prediction needs work on the “unrestricted” mode to meet its operational goals.

Gust Front location estimates meet the goals for Memphis, but not for MCO. Analysis of data from different climate regimes is needed. Although the number of cases in the analysis is limited, the wind shift estimate does not meet the accuracy goals.

The Terminal Winds product meets its goals.

SCI, SEP, and Terminal Weather Text Messages products need to account for storm growth and/or decay to meet their operational goals.

BIBLIOGRAPHY

Dasey, T. J., A. P. Denneno, and R. Boldi, 1995: The Integrated Terminal Weather System (ITWS) Storm Cell Information Algorithm, Preprints of the 6th International Conference on Aviation Weather Systems, (#10.3) January 1995, Dallas, TX, Amer. Meteor. Soc., 45 Beacon St., Boston, MA.

Chornoboy, E. S., 1991: Storm Tracking for TDWR: A Correlation Algorithm Design and Evaluation, FAA Report DOT/FAA/NR-91/8 (ATC-182), MIT Lincoln Laboratory, 244 Wood St., Lexington, MA 02173, 83 pp.

Chornoboy, E. S., 1994: The Effect of ITWS Precipitation Data Rate on Storm Motion Accuracy, FAA Report DOT/FAA/NR-9 (ATC-182), MIT Lincoln Laboratory, 244 Wood St., Lexington, MA 02173, 83 pp.

Chornoboy, E. S. and A. M. Matlin, 1994: Extrapolating Storm Location using the Integrated Terminal Weather System (ITWS) Storm Motion Algorithm, FAA Report DOT/FAA/RD-94/2 (ATC-208), MIT Lincoln Laboratory, 244 Wood St., Lexington, MA 02173, 71pp.

Cole, R. and R. Todd, 1993: "A Comparison of Windshear Detection Algorithms", Proc. Fifth Intl. Conf. on Aviation Weather Systems, Vienna, VA., pp. 103-107.

Eilts, M., J. T. Johnson, E. D. Mitchell, S. Sanger, G. Stumpf and A. Witt, 1995: Warning Decision Support System. Preprints, 11th Conference on Interactive Information and Processing Systems, January 1995, Dallas, TX, Amer. Meteor. Soc., 45 Beacon St., Boston, MA..

Klinge-Wilson, D., M. Donovan, S. Olson, and F. W. Wilson, 1992: A comparison of the performance of two gust front detection algorithms using a length-based scoring technique, Project Report ATC-185, DOT/FAA/NR-92/1, MIT Lincoln Laboratory, Lexington, MA.

Klinge-Wilson, D., E. Mann, and R. Boldi, 1995: An Algorithm to Remove Anomalous Propagation Clutter Returns from ASR-9 Weather Channel Data using Pencil Beam Radar Data, Preprints of the 6th International Conference on Aviation Weather Systems, (#10.3) January 1995, Dallas, TX, Amer. Meteor. Soc., 45 Beacon St., Boston, MA.

Troxel, S., and R. L. Delanoy, 1994: Machine intelligent Approach to Automated Gust Front Detection for Doppler Weather Radars, SPIE Proceedings - Sensing, Imaging, and Vision for Control and Guidance of Aerospace Vehicles, V. 2220, Orlando, FL, pp. 182-192.

Weber, M. E., 1986: Assessment of ASR-9 Weather Channel Performance: Analysis and Simulation, Project Report ATC-138, FAA-RD-PS-88-11, MIT Lincoln Laboratory, Lexington, MA.

Weber, M. E., M. L. Stone, and J. A. Cullen, 1993: Anomalous propagations associated with thunderstorm outflows, Preprints of the 26th International Conference on Radar Meteorology, May 1993, Norman, OK, Amer. Meteor. Soc., 45 Beacon St., Boston, MA.

Wolfson, M. M., R.L. Delanoy, B.E. Forman, R.G. Hallowell, M.L. Pawlak, P.D. Smith, "Automated Microburst Windshear Prediction," The Lincoln Laboratory Journal, v. 7, no. 2, 1995

**APPENDIX A.
LIST OF ACRONYMS AND ABBREVIATIONS**

AGFS	Aviation Gridded Forecast System
AP	anomalous propagation
ARENA	area noted for attention
ARP	Airport Reference Point
ARTCC	Air Route Traffic Control Center
ASR	Airport Surveillance Radar
ATC	Air Traffic Control
ATCT	Airport Traffic Control Tower
CFP	correct forecast probability
comprefl	composite reflectivity
DemVal	Demonstration and Evaluation
FAA	Federal Aviation Administration
FFP	false forecast probability
ITWS	Integrated Terminal Weather System
LLWAS	Low Level Windshear Alert System
MBA	microburst alert

MDCRS	Meteorological Data Collection and Reporting System
MOPR	minimum operational performance requirements
NEXRAD	Next Generation Weather Radar
NLDL	National Lightning Data Network
NWS	National Weather Service
ONERA	Office Nationale D–Etudes et de Recherches Aerospatiales
PAWS	probability of accurate wind shift
PEAP	probability of editing AP
PEW	probability of editing weather
PEWS	probability of erroneous wind shift
PFA	probability of false alarm
PFd	percent of false length detected
PFld	probability of generating a correct forecast, given a detection
PFle	probability of generating a correct forecast, given an event
PFP	probability of false prediction
PLD	percent of length detected
POD	probability of detection

POP	probability of correct prediction
POSH	probability of severe hail
PWSA	probability of generating a correct wind shear alert
PWSFA	probability that wind shear alert is false
SCI	Storm Cell Information
SEP	Storm Extrapolated Position
SSA	Storm Structures Algorithm
TDWR	Terminal Doppler Weather Radar
TRACON	Terminal Radar Approach Control
UT	Coordinated Universal Time
VIL	vertically integrated liquid water
VIP	Video Integrator and Processor
WSA	wind shear alert

APPENDIX B.
DAY-BY-DAY MICROBURST PREDICTION STATISTICS

Table B-1.
**Day-by-day performance statistics for the microburst prediction algorithm
for Memphis, TN.**

DATE & TIME (UT)	POP		PFP		LEAD TIME (SECS)	
	RES	UNRES	RES*	UNRES	RES**	UNRES
6-3-94 1744-1840 2100-2245	1.00 (2/2)	1.00 (2/2)	0.00 (0/2)	0.20 (12/61)	282,96	378,378
6-4-94 1910-2000	-	-	-	0.00 (0/19)	-	-
6-6-94 2220-2259 2315-0050	0.50 (1/2)	0.50 (1/2)	0.00 (0/2)	0.00 (0/5)	117,-	282,-
6-7-94 0710-0810 1015-1045	0.00 (0/1)	0.00 (0/1)	0.00 (0/1)	1.00 (49/49)	-	-
6-9-94 1722-1828	-	-	-	1.00 (7/7)	-	-
6-16-94 2230-2315	0.00 (0/1)	0.00 (0/1)	0.00 (0/1)	0.09 (3/33)	-	-
6-17-94 2007-2051	-	-	-	-	-	-
6-21-94 2155-2320	-	-	-	-	-	-

* The PFP for the restricted case at the wind shear level is 0.0 because a prediction must overlap a wind shear event to be issued.

** The lead time for each microburst is reported separately in this column. A lead time of 0 indicates no lead time and a dash (-) indicates a microburst for which no prediction was issued.

Table B-1 continued.

DATE & TIME (UT)	POP		PFP		LEAD TIME (SECS)	
	RES	UNRES	RES*	UNRES	RES**	UNRES
6-22-94 2000-2107	1.00 (2/2)	1.00 (2/2)	0.00 (0/2)	0.00 (0/19)	128, 0	128,172
6-24-94 0725-0924	-	-	-	1.00 (14/14)	-	-
6-26-94 1145-1424	0.00 (0/1)	0.00 (0/1)	0.00 (0/1)	1.00 (20/20)	-	-
6-28-94 1405-1440	1.00 (3/3)	1.00 (3/3)	0.00 (0/3)	0.13 (3/23)	60,240 467	128,522 467
6-29-94 1111-1208	1.00 (1/1)	1.00 (1/1)	0.00 (0/1)	0.00 (0/4)	96	96
6-30-94 1652-1738	1.00 (1/1)	1.00 (1/1)	0.00 (0/1)	0.00 (0/12)	58	467
7-4-94 0000-0100	-	-	-	1.0 (6/6)	-	-
7-4-94 1840-1940 2205-2330	0.86 (6/7)	0.86 (6/7)	0.00 (0/7)	0.86 (6/7)	-,282 118,0,117 282,186	-,282,468 0,467 446,186
7-6-94 2127-2242	1.00 (4/4)	1.00 (4/4)	0.00 (0/4)	0.16 (8/51)	68,282 55,223	350,350 241,350
7-8-94 1332-1358	-	-	-	1.00 (4/4)	-	-
7-9-94 1811-1838	-	-	-	0.00 (0/1)	-	-

* The PFP for the restricted case at the wind shear level is 0.0 because a prediction must overlap a wind shear event to be issued.

** The lead time for each microburst is reported separately in this column. A lead time of 0 indicates no lead time and a dash (-) indicates a microburst for which no prediction was issued.

Table B-1 continued.

DATE & TIME (UT)	POP		PFP		LEAD TIME (SECS)	
	RES	UNRES	RES*	UNRES	RES**	UNRES
7-11-94 2227-2254	-	-	-	0.00 (0/6)	-	-
TOTALS	0.80 (20/25)	0.80 (20/25)	0.00 (0/25)	0.39 (132/341)	126	246

* The PFP for the restricted case at the wind shear level is 0.0 because a prediction must overlap a wind shear event to be issued.

** The lead time for each microburst is reported separately in this column. A lead time of 0 indicates no lead time and a dash (-) indicates a microburst for which no prediction was issued.

Table B-2.
Day-by-day performance statistics for the microburst prediction algorithm
for Orlando, FL.

DATE & TIME (UT)	POP		PFP		LEAD TIME (SECS)	
	RES	UNRES	RES*	UNRES	RES**	UNRES
7-14-94 2000-2200	0.80 (4/5)	0.80 (4/5)	0.00 (0/5)	0.13 (14/105)	290,114 114,0 -	643,177 467,527 -
7-16-94 2012-2120	0.50 (1/2)	0.50 (1/2)	0.00 (0/2)	0.03 (1/30)	73,-	73,-
7-21-94 1504-1739	0.83 (5/6)	1.00 (6/6)	0.00 (0/6)	0.03 (1/40)	0,0 41,114 237,-	578,0 104,177 237,289
7-27-94 1936-2049	1.00 (1/1)	1.00 (1/1)	0.00 (0/1)	0.20 (3/15)	115	353
7-28-94 1819-1936	0.00 (0/3)	0.33 (1/3)	0.00 (0/3)	0.42 (31/74)	-,,-	-,248,-
7-30-94 2032-2200	0.50 (1/2)	0.50 (1/2)	0.00 (0/2)	0.55 (12/22)	0,-	0,-
8-9-94 1929-2139	0.00 (0/1)	1.00 (1/1)	0.00 (0/1)	0.00 (0/4)	-	538
8-15-94 1952-2114	0.40 (2/5)	0.40 (2/5)	0.00 (0/5)	0.03 (1/39)	185,174 -,,-	185,527 -,,-
TOTALS	0.56 (14/25)	0.68 (17/25)	0.00 (0/25)	0.19 (63/329)	58	205

* The PFP for the restricted case at the wind shear level is 0.0 because a prediction must overlap a wind shear event to be issued.

** The lead time for each microburst is reported separately in this column. A lead time of 0 indicates no lead time and a dash (-) indicates a microburst for which no prediction was issued.

APPENDIX C
MEMPHIS GUST FRONT WIND SHIFT AND WIND SHEAR DATA
USED FOR PERFORMANCE EVALUATION

		WIND SHIFT						WIND SHEAR	
		MIGFA		LLWAS TRUTH		TDWR TRUTH		MIGFA	TRUTH
Date	Time (GMT)	Dir	Speed (m/s)	Dir	Speed (m/s)	Dir	Speed (m/s)	DV (m/s)	DV (m/s)
06/05/94	2005	183.5	4.2	198.3	3.7	200	4.0	4.2	2.0
06/07/94	0339	330.6	6.4	0.2	4.7	355	6.0	9.4	11.4
06/07/94	0523	332.3	6.7	294.4	6.5	310	9.0	6.9	7.4
06/07/94	0805	278.5	4.9	313.8	6.2	350	6.0	8.0	9.0
06/09/94	1758	283.1	21.0	280.0	18.4	300	24.0	9.5	13.8
06/16/94	2123	85.1	6.1	140.0	6.2	160	6.5	4.3	5.0
06/22/94	2034	140.7	7.7	163.3	10.6	180	10.0	6.9	9.0
06/28/94	1420	343.7	14.6	47.1	4.2	20	5.0	10.7	12.0
07/01/94	0244	283.7	8.0	248.8	2.5	300	1.0	12.3	12.0
07/03/94	2346	134.9	6.0	160.0	5.8	160	6.0	3.3	4.2
07/04/94	2310	52.4	3.5	320.0	1.0	330	2.0	5.3	4.5
07/05/94	1959	54.0	2.9	176.7	2.0	40	1.0	5.2	4.5
07/06/94	2226	48.8	5.3	67.6	6.6	40	8.0	6.4	6.5
07/08/94	1337	311.1	5.3	291.0	4.7	290	6.0	7.0	6.5
07/08/94	1850	289.1	6.1	257.9	5.3	300	4.5	10.5	11.0
07/08/94	1835	287.2	3.9	253.1	3.4	300	4.0	5.1	2.0
07/08/94	2148	136.3	9.4	160.0	7.5	160	8.0	4.6	2.8