

DOT-FAA-PM-83/9

**Project Report
ATC-118**

**Traffic Alert and Collision Avoidance
System (TCAS): A Functional Overview
of Active TCAS I**

**V. A. Orlando
J. D. Welch**

8 April 1983

Lincoln Laboratory
MASSACHUSETTS INSTITUTE OF TECHNOLOGY
LEXINGTON, MASSACHUSETTS

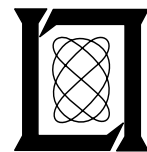

Prepared for the Federal Aviation Administration,
Washington, D.C. 20591

This document is available to the public through
the National Technical Information Service,
Springfield, VA 22161

This document is disseminated under the sponsorship of the Department of Transportation in the interest of information exchange. The United States Government assumes no liability for its contents or use thereof.

1. Report No. DOT-FAA-PM-83/9	2. Government Accession No.	3. Recipient's Catalog No.	
4. Title and Subtitle Traffic Alert and Collision Avoidance System (TCAS): A Functional Overview of Active TCAS I		5. Report Date 8 April 1983	6. Performing Organization Code
7. Author(s) V.A. Orlando and J.D. Welch		8. Performing Organization Report No. ATC-118	
9. Performing Organization Name and Address Massachusetts Institute of Technology Lincoln Laboratory P.O. Box 73 Lexington, MA 02173		10. Work Unit No. Project No. 054-241-04	11. Contract or Grant No. DOT-FA72-WAI-817
12. Sponsoring Agency Name and Address Department of Transportation Federal Aviation Administration Systems Research and Development Service Washington, D.C. 20591		13. Type of Report and Period Covered	
15. Supplementary Notes The work reported in this document was performed at Lincoln Laboratory, a center for research operated by Massachusetts Institute of Technology under Air Force Contract F19628-80-C-0002.		14. Sponsoring Agency Code	
16. Abstract The Traffic Alert and Collision Avoidance System (TCAS) is a beacon-based airborne collision avoidance system that is able to operate in all airspace without reliance on ground equipment. The TCAS concept encompasses a range of capabilities that include TCAS I, a low-cost, limited-performance version, and TCAS II, which is intended to provide a comprehensive level of separation assurance in all current and predicted airspace environments through the end of this century. This document provides a functional overview of a TCAS I equipped with a low power active transponder detector. It includes a definition of TCAS I functions, calculated and measured surveillance performance for a low power interrogator and an implementation approach that incorporates the TCAS I functions in a Mode S transponder.			
17. Key Words Collision Avoidance Mode S Data Link		18. Distribution Statement Document is available to the public through the National Technical Information Service, Springfield, Virginia 22151	
19. Security Classif. (of this report) Unclassified	20. Security Classif. (of this page) Unclassified	21. No. of Pages 36	22. Price

TABLE OF CONTENTS

Introduction	1
TCAS II	3
Active TCAS I Overview	4
Air Traffic Control Radar Beacon System	6
Mode Select Beacon System	8
TCAS I Functions and Components	10
TCAS I Block Diagram: Active Detector	12
Active TCAS I Interference Considerations	14
Active TCAS I Tracking Probability	16
Validation of Calculated Active TCAS I Performance	18
Active Detector Characteristics	20
Active TCAS I Performance Measurements	22
Implementation Requirements	24
TCAS I Active Transponder Detector	26
Summary	28
References	31

INTRODUCTION

TCAS Concept

In recent years the development of airborne collision avoidance systems has focused on concepts that make use of the transponders carried for ground ATC purposes and hence do not impose the need for special avionics on board the intruding aircraft. Such systems have the advantage that they can provide immediate protection against collisions involving a significant and growing fraction of the aircraft population.

One system based on this technique is the Traffic Alert and Collision Avoidance System (TCAS). TCAS, like its predecessor BCAS (Beacon Collision Avoidance System), is designed to provide protection against aircraft equipped with both the current (ATCRBS) and future (Mode S) air traffic control transponders.

TCAS encompasses a range of capabilities that includes (a) TCAS I, a low-cost, limited-performance version, and (b) TCAS II, which is intended to provide a comprehensive level of separation assurance in all current and predicted airspace environments through the end of this century.

TCAS I

TCAS I [1] has the ability to receive and display the traffic advisories crosslinked by TCAS II. It also has the ability to sense the presence of and display traffic advisories on nearby aircraft by detecting their transponder's transmissions (replies) at 1090 MHz. The replies detected may have been elicited by ground station interrogations or by spontaneous transmissions of Mode S transponders (passive TCAS I) or may have resulted from low power interrogations from TCAS I (active TCAS I). Enhancements of TCAS I can take many forms. In particular, on-board direction-finding antennas could be used to augment the range and altitude information obtained from transponder replies.

(Intentionally left blank)

TCAS II

Without reliance on ground equipment, TCAS II [2] is capable of providing resolution advisories in the vertical dimension (climb, descend) in airspace densities up to 0.3 aircraft per square nautical mile (or approximately 24 aircraft within 5 nautical miles of the TCAS II aircraft). Traffic advisories on nearby aircraft may also be provided. These include the clock position, or bearing, of the intruding aircraft. The TCAS II uses the Mode S data link to transmit advisories to nearby TCAS I aircraft. These crosslinked advisories provide the position of the TCAS II aircraft as seen from the TCAS I aircraft. The Mode S air-to-air data link is also used to coordinate escape maneuvers among TCAS II aircraft that are in conflict.

It is important to ensure that the secondary surveillance radar signals transmitted by TCAS II avionics do not degrade the ability of ground-based ATC radars to sense traffic. TCAS II includes interference limiting algorithms that are designed to ensure that the ability of ground secondary surveillance radars to receive replies in response to interrogations is not reduced by more than 2 percent as a result of TCAS II operation.

A more capable system, called enhanced TCAS II, uses more accurate intruder bearing data to allow it to reduce unnecessary alarms (by estimating the horizontal miss distance) and to generate horizontal resolution advisories (turn right, turn left).

ACTIVE TCAS I OVERVIEW

This report presents a functional overview of the active TCAS I system.

The report begins with a description of the active transponder detector technique investigated, along with examples of measured flight test performance. Next, the complexity of the TCAS I is analyzed and an approach for incorporating TCAS I functions in a Mode S transponder is described.

The paper concludes with a summary of the key points.

ACTIVE TCAS I OVERVIEW

- BEACON SYSTEM DEFINITION
- TCAS I CONCEPT
- ACTIVE TCAS I TECHNIQUES AND PERFORMANCE
- ACTIVE TCAS I IMPLEMENTATION APPROACH
- SUMMARY

AIR TRAFFIC CONTROL RADAR BEACON SYSTEM

The operation of the current Air Traffic Control Radar Beacon System (ATCRBS) is illustrated schematically in the figure. ATCRBS uses simple two-pulse interrogations transmitted from a rotating antenna. Two types of interrogations are used for civil transponders: Mode A which elicits one of 4096 identity codes; and Mode C which elicits a similar 12-bit code containing the aircraft's barometric altitude, referenced to standard atmospheric conditions.

Since all equipped aircraft in the antenna mainbeam respond to each ATCRBS interrogation, it is common for replies from aircraft at nearly the same ranges to overlap each other at the interrogator receiver. This phenomenon is called synchronous garble. It is controlled in the ground system by using a narrow antenna beamwidth and by restricting each sensor to the absolute minimum range required for air traffic control purposes.

At short ranges, the signal strength may be sufficient to interrogate transponders via leakage through the antenna sidelobes. To control this phenomenon, aircraft in the antenna sidelobes are prevented from replying by a technique known as transmit sidelobe suppression. The P2 pulse of the interrogation is transmitted on an omni-directional antenna at a slightly higher power level than the interrogator power produced by the antenna sidelobes. Transponders are designed to reply only if the received P1 pulse is greater than the received P2 pulse. This condition is not satisfied in the sidelobes of the antenna.

AIR TRAFFIC CONTROL RADAR BEACON SYSTEM (ATCRBS)

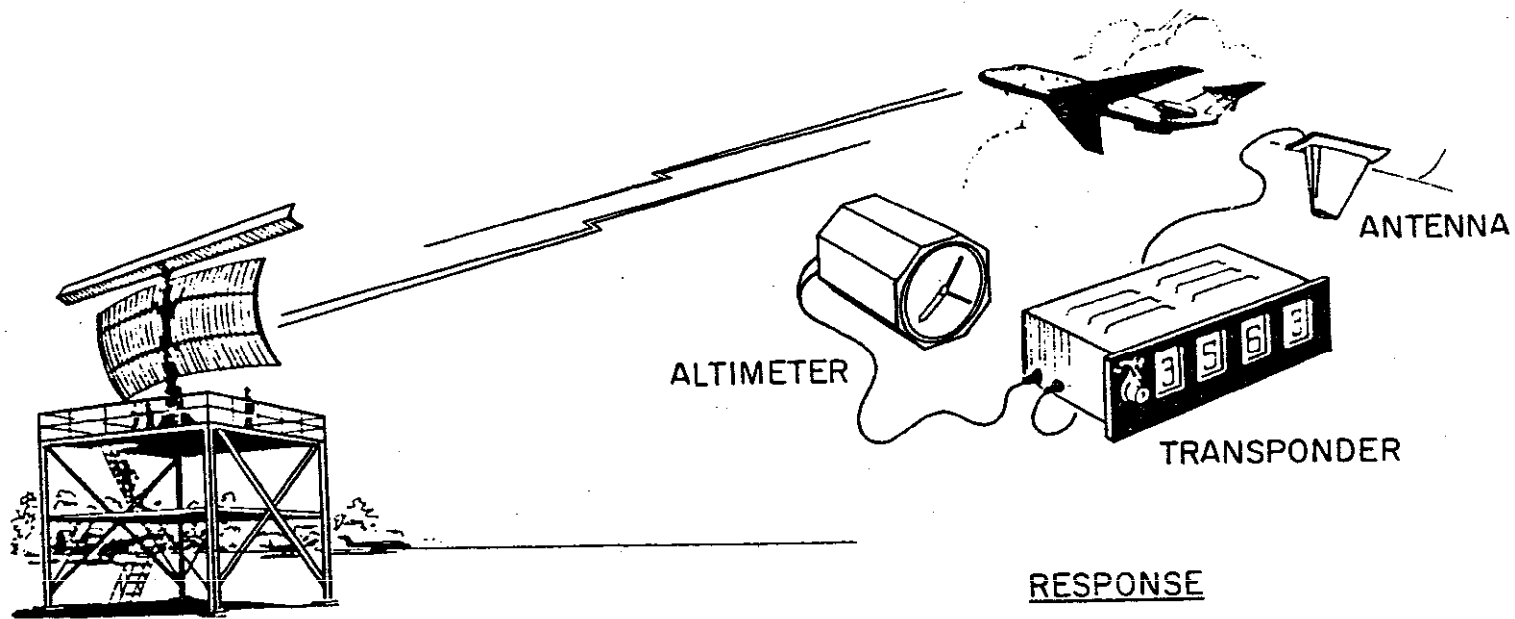

INTERROGATION

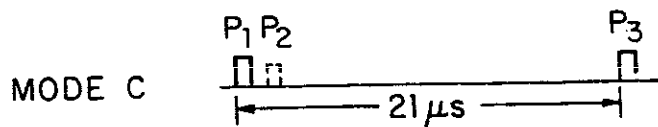
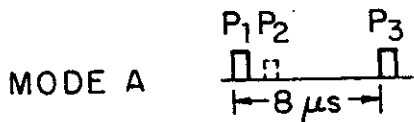

RESPONSE

IDENTIFICATION CODE

3563

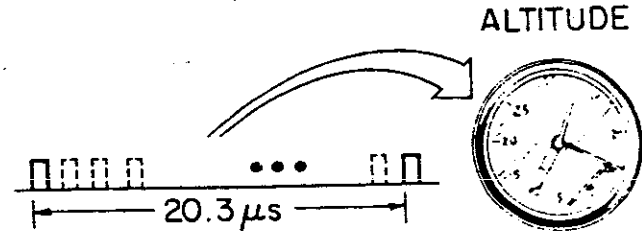
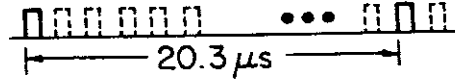

ALTITUDE

ATC-118-2

MODE SELECT BEACON SYSTEM

The Mode Select (Mode S) beacon system [3] was developed as an evolutionary improvement to the ATCRBS system to enhance air traffic control surveillance reliability and to provide a ground-air-ground digital data communication capability. Each aircraft is assigned a unique address code which permits data link messages to be transferred along with surveillance interrogations and replies.

Like ATCRBS, Mode S will locate an aircraft in range and azimuth, report its altitude and identity, and provide the general surveillance service currently available. However, because of its ability to selectively interrogate only those aircraft within its area of responsibility, Mode S can avoid the interference which results when replies are generated by all the transponders within the beam. If Mode S schedules its interrogations appropriately, responses from aircraft will not overlap each other at the receiver.

The Mode S signal formats are illustrated in the figure. Mode S uses the same frequencies as ATCRBS for interrogations and replies (1030 and 1090 MHz, respectively). The Mode S interrogation consists of a two-pulse preamble plus a string of 56 or 112 data bits (including the 24-bit address) transmitted using binary differential phase shift keying (DPSK) at a 4 Mbps rate. The preamble pulses are 0.8 μ sec wide and are spaced 2.0 μ sec apart. An ATCRBS transponder that receives the interrogation interprets this pulse pair as an ATCRBS sidelobe suppression, causing it to be suppressed for the remainder of the Mode S interrogation. Without such suppression, the following Mode S data block would, with high probability, trigger ATCRBS transponders causing spurious replies.

The reply also comprises 56 or 112 bits including address, and is transmitted at 1 Mbps using binary pulse-position modulation (PPM). The four-pulse reply preamble is designed to be easily distinguished from an ATCRBS reply sequence. It can be reliably recognized and used as a source of reply timing even in the presence of an overlapping ATCRBS reply, while at the same time achieving a low rate of false alarms arising from multiple ATCRBS replies.

The Mode S parity coding scheme is designed so that an error occurring anywhere in an interrogation or a reply will modify the decoded address. If there is an error on the uplink, the transponder will not accept the message and will not reply, since the interrogation does not appear to be addressed to it. If there is an error on the downlink, the interrogator will recognize that an error has occurred, since the reply does not contain the expected address. This error detection feature along with the ability to reinterrogate a particular aircraft if a reply is not correctly received gives Mode S the required high surveillance and communications reliability.

MODE S INTERROGATION AND REPLY WAVEFORMS

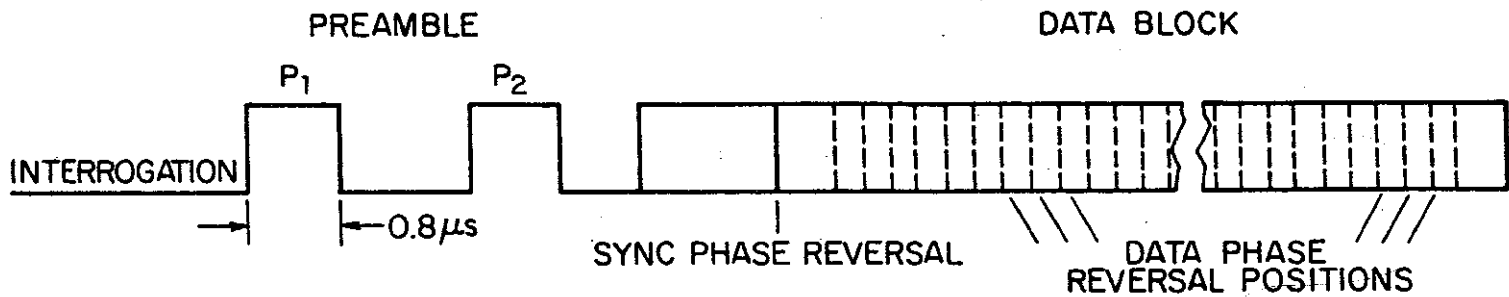

INTERROGATION

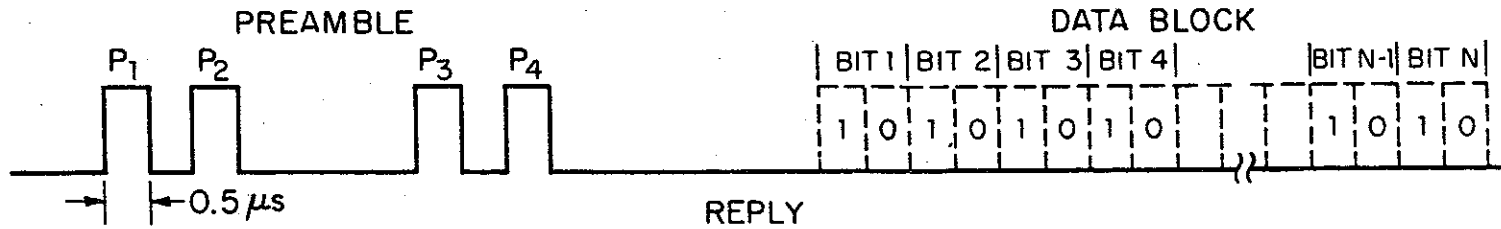

REPLY

ATC-118-3

TCAS I FUNCTIONS AND COMPONENTS

There are three main characteristics of TCAS I:

1. TCAS I is able to respond with encoded altitude to interrogations from the air traffic control system on the ground and from airborne TCAS II units. Thus it includes a transponder and an encoding altimeter.
2. TCAS I has a means for displaying the traffic advisory received from TCAS II. This information is crosslinked from TCAS II to the transponder in the TCAS I aircraft. The crosslink message is discretely addressed to the TCAS I aircraft using Mode S signaling. Thus, the TCAS I transponder must be a Mode S transponder with an associated pilot display.
3. TCAS I has the capability of detecting transmissions from nearby transponders and alerting the pilot when the characteristics of any transmission indicate that it might be a threat. Thus it has some form of transponder detector.

TCAS I FUNCTIONS AND COMPONENTS

- **PROVIDES SURVEILLANCE ELEMENT FOR GROUND AND TCAS II**
 - **TRANSPONDER**
 - **ENCODING ALTIMETER**

- **DISPLAYS TRAFFIC ADVISORY CROSSLINKED FROM TCAS II**
 - **TRANSPONDER MUST BE MODE S**
 - **TCAS II TRAFFIC ADVISORY DISPLAY**

- **DETECTS TRANSMISSIONS FROM NEARBY TRANSPONDERS**
 - **PASSIVE OR ACTIVE TRANSPONDER DETECTOR**

ATC-118-4

TCAS I BLOCK DIAGRAM: ACTIVE DETECTOR

The figure shows the block diagram of TCAS I with a low power active detector. Note that:

1. The active detector transmits a standard ATCRBS Mode C interrogation and thus receives ATCRBS replies from ATCRBS and Mode S transponders.
2. Detection is provided for both ATCRBS and Mode S aircraft in regions where there is no ground interrogator.
3. Mutual suppression is required since both transponder and detector operate on both beacon frequencies.

TCAS I BLOCK DIAGRAM ACTIVE DETECTOR

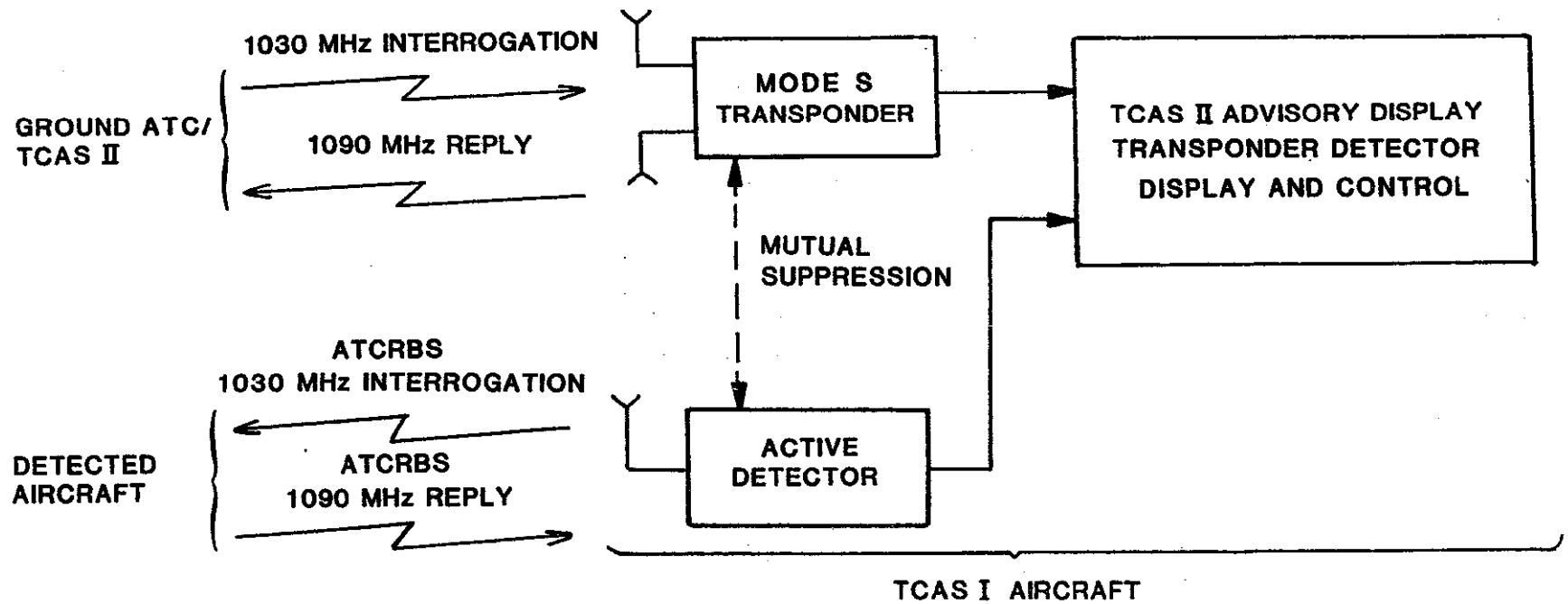

ATC-118-5

ACTIVE TCAS I INTERFERENCE CONSIDERATIONS

An active detector approach is feasible only if a transmitted power that causes a negligible increase in signal interference also gives a useful detection range.

An analysis was conducted to determine the power level that could be employed by 50% of the aircraft in the high traffic densities (0.3 aircraft per square nmi) and that would cause no more than 10% of the signal interference generated by TCAS II operation. The result was a transmitted power equivalent to one 5.0-watt Mode C interrogation every second (i.e., one 5.0-watt interrogation per second, or one 10.0-watt interrogation every 2 seconds, etc.).

ACTIVE TCAS I INTERFERENCE CONSIDERATIONS

CONSTRAINTS

- 50% IMPLEMENTATION IN ANY AIRSPACE
- NEGLIGIBLE INTERFERENCE TO GROUND AND TCAS II ENVIRONMENT

RESULTS

- TRANSMIT POWER EQUAL TO ONE, 5.0 WATT MODE C INTERROGATION/SEC

ATC-118-6

ACTIVE TCAS I TRACKING PROBABILITY

Calculated values of tracking probability for several peak powers are shown in the figure. The performance at 4 watts is also shown since flight test data were available at that power level. Note that the calculated performance for a 20-watt Mode C interrogation (every 4 seconds) yields good detector performance out to 2 nautical miles.

This performance prediction assumes no loss in detection due to synchronous garble and is therefore only applicable to densities where no more than one aircraft (on average) is within garble range. This "single-aircraft" density is shown for each of the ranges calculated. For active TCAS I units with a degarbling capability, reliable TA's would be possible in somewhat higher traffic densities.

The density of 0.024 aircraft/nmi² for a 2-mile range is equivalent to the current density outside of the TCA in the Boston and Washington areas.

**CALCULATED VALUES OF TRACKING PROBABILITY
FOR A LOW POWER TCAS I DETECTOR**

RANGE (NMI)	INTERROGATOR POWER (AT ANTENNA)				OPERATIONAL DENSITY
	4 WATTS	5 WATTS	10 WATTS	20 WATTS	AC/NMI ²
1	0.90	0.93	0.97	0.99	0.047
2	0.67	0.72	0.84	0.93	0.024
3	0.47	0.53	0.69	0.83	0.015
4	0.33	0.38	0.56	0.72	0.010

ATC-118-7

VALIDATION OF CALCULATED ACTIVE TCAS I PERFORMANCE

A comparison of calculated and measured performance for the 4-watt case is shown in the figure. The airborne measurements are seen to be in reasonably good agreement with the calculated performance.

ACTIVE TCAS PERFORMANCE AS A FUNCTION OF RANGE

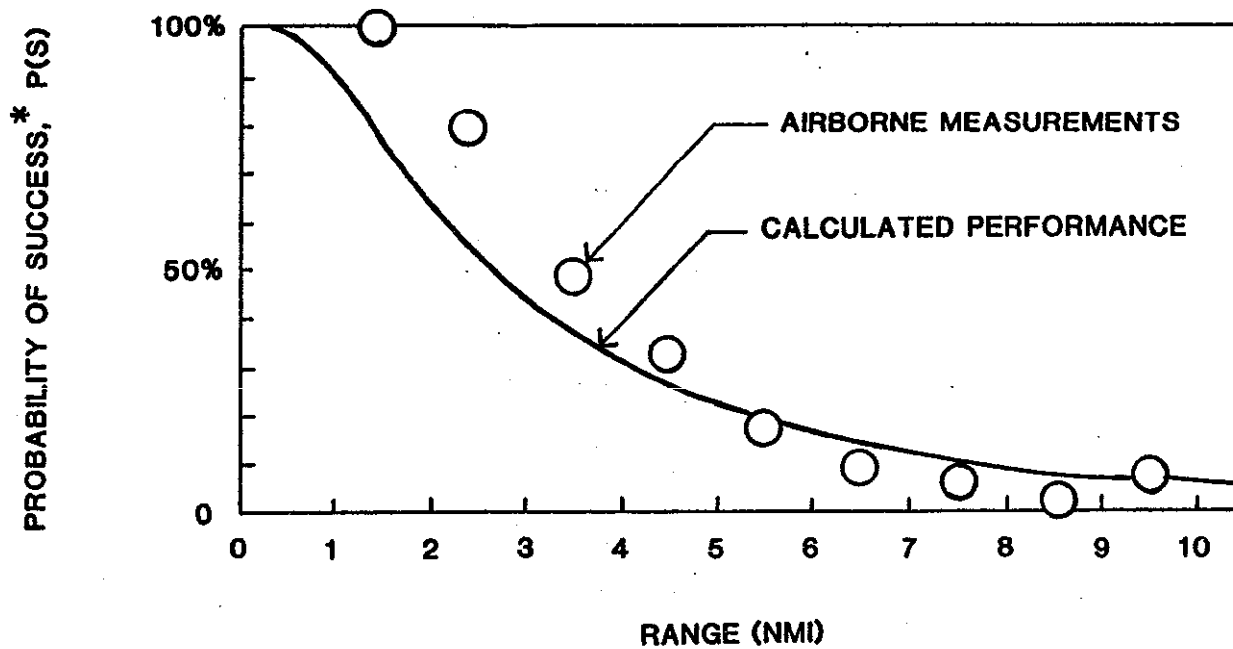

* PERCENT OF AIRCRAFT FROM WHICH REPLIES ARE ELICITED BY A 4-WATT INTERROGATION, FOR AIRCRAFT WITHIN $\pm 10^\circ$ IN ELEVATION ANGLE

ATC-118-8

ACTIVE DETECTOR CHARACTERISTICS

A functional block diagram of a possible TCAS I active transponder detector is shown in the figure. A single 20-watt Mode C interrogation is generated once every four seconds. This standard ATCRBS interrogation elicits ATCRBS replies from both ATCRBS and Mode S aircraft. The interrogation is followed by a listening interval of approximately 55 μ sec, which is sufficient to receive replies from aircraft up to three nautical miles away. Received replies are tracked to eliminate fruit. A top-mounted antenna is used to minimize the effect of reflections from the ground.

In addition to active surveillance, the detector shown also includes provisions for rejecting replies that are not near the TCAS I altitude. The alarm logic for the active detector can track range to derive range rate. This makes it possible to base alerts on range closure as well as range and altitude proximity, and should therefore help keep the false alarm rate relatively low.

TCAS I ACTIVE DETECTOR FUNCTIONAL BLOCK DIAGRAM

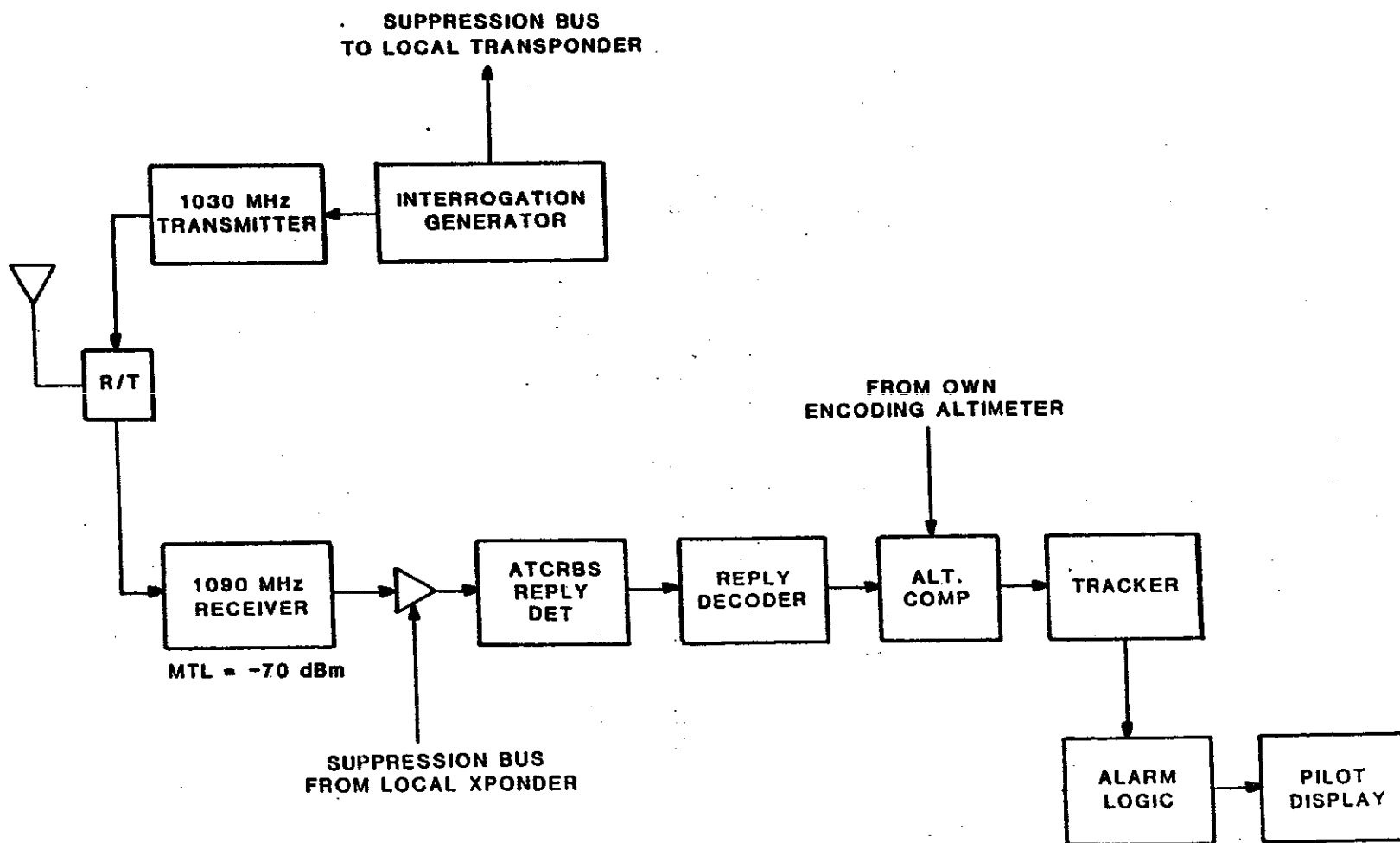

ATC-118-9

ACTIVE TCAS I PERFORMANCE MEASUREMENTS

An example of flight test performance for a 4-watt active interrogator is shown in the figure. The solid lines represent the location of aircraft as determined by an experimental TCAS II unit installed in the flight test aircraft with the TCAS I, and operating at full power. The dots indicate regions where the 4-watt interrogator also elicited replies.

ACTIVE TCAS I PERFORMANCE - BOSTON TO NEW YORK

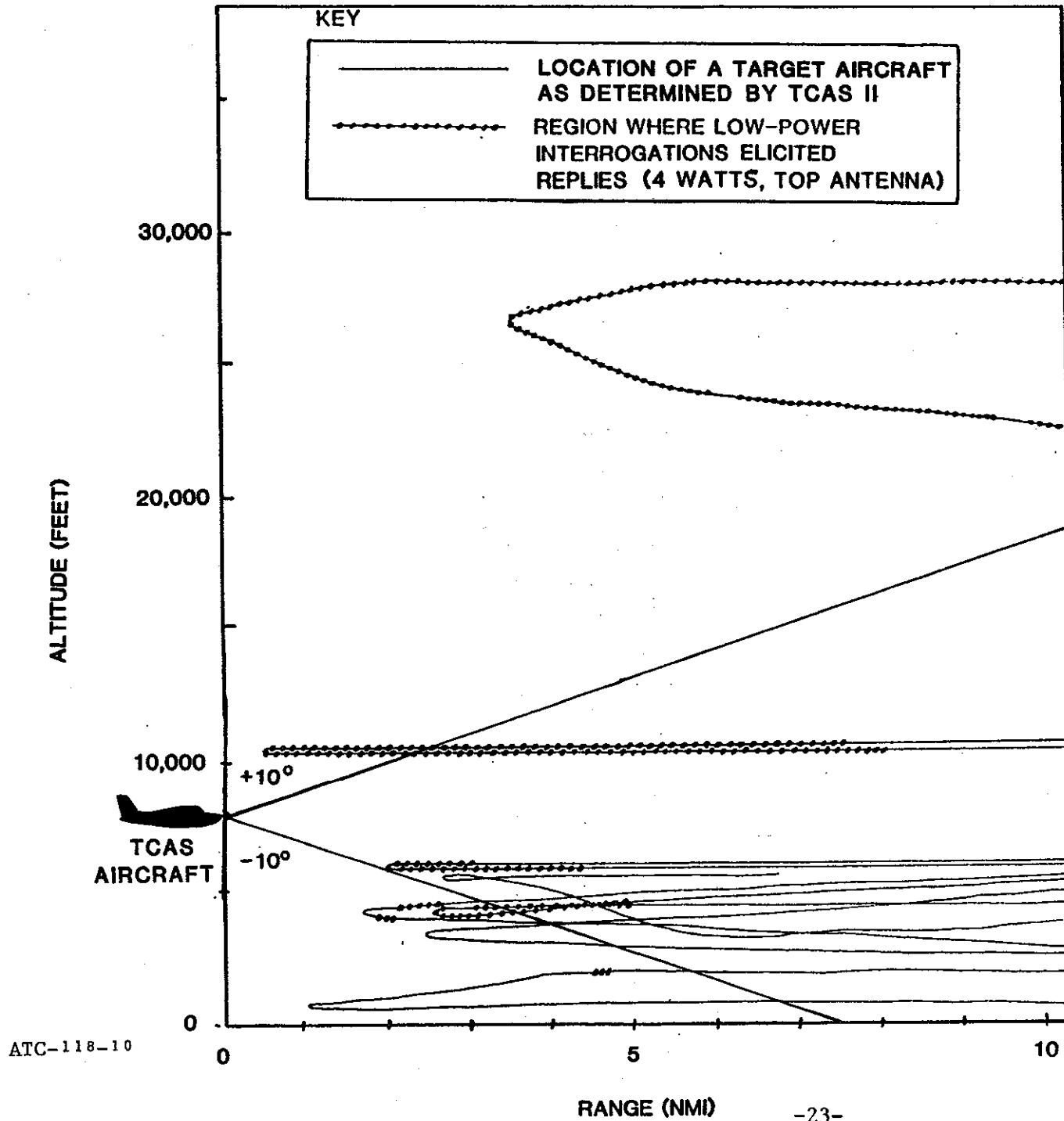

IMPLEMENTATION REQUIREMENTS

Every TCAS I incorporates a Mode S transponder (shown at the top of the figure). The use of an active transponder detector requires, in effect, another transponder complete with receiver, transmitter, and logic but operating on the opposite beacon frequencies. However, this "inverted" transponder is active for less than 100 μ sec every second. It thus appears practical to time share the Mode S receiver and transmitter between the transponder and active detector tasks.

Details of this realization of an active detector are given in the following figure.

TCAS I IMPLEMENTATION REQUIREMENTS

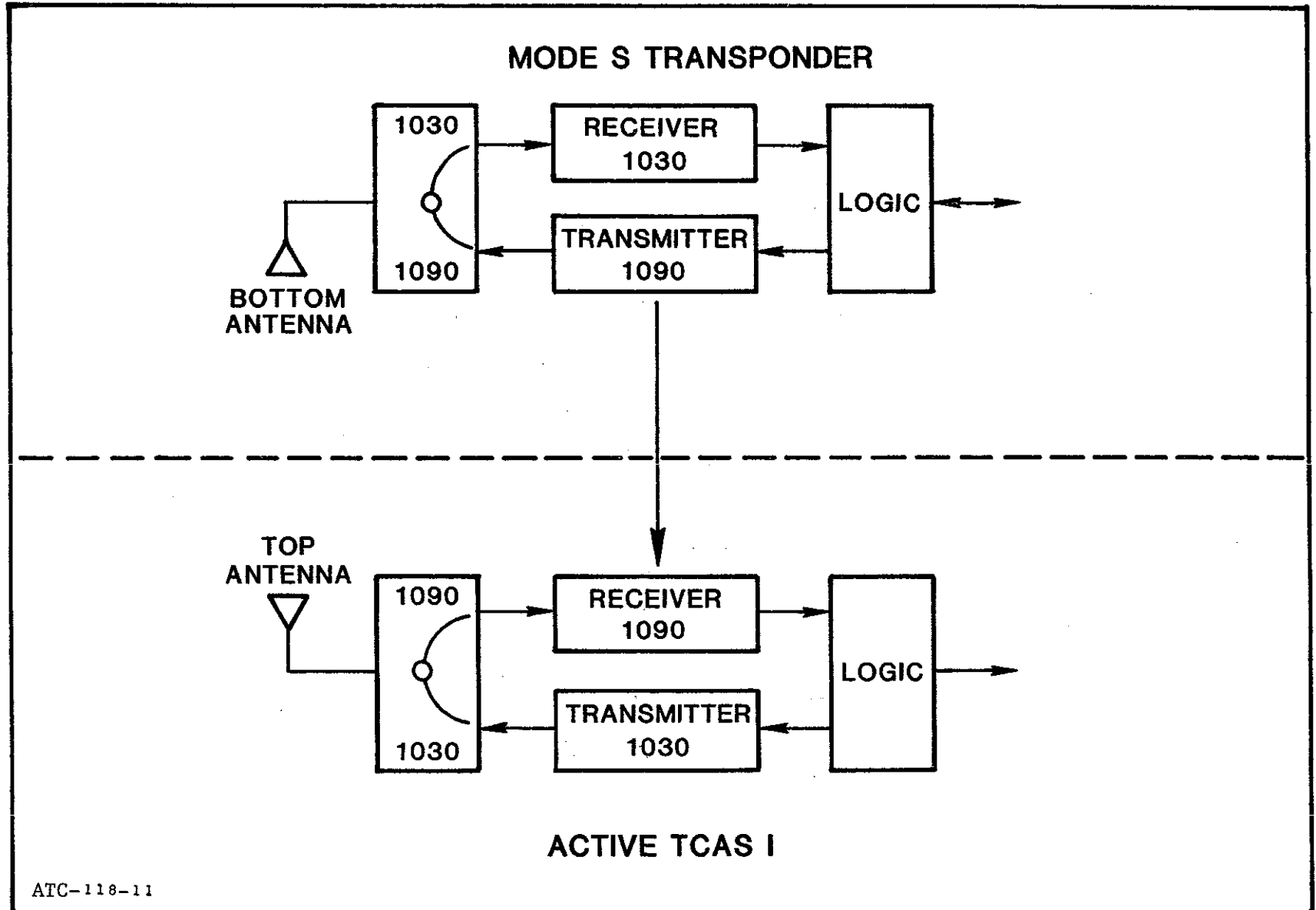

TCAS I ACTIVE TRANSPONDER DETECTOR

This implementation of a TCAS I active transponder detector uses the Mode S transponder in a time-sharing mode. The double-boxed elements in the diagram are those assemblies that must be added to the transponder to reconfigure it to a TCAS I active detector. Switches effect the reconfiguration and frequency change. Note that there is no need for extreme speed or efficiency in the reconfiguration switches since: (1) time is available for switching, (2) insertion loss in RF energy switching is not critical since sensitivity and RF power output for the transponder detector are respectively about 4 dB and 20 dB less than the levels required for the Mode S transponder function, (3) Local Oscillator and Master Oscillator frequency switching can be done at the DC level, and (4) mode decoder switching is strictly a logic function.

TCAS I ACTIVE TRANSPONDER DETECTOR IMPLEMENTATION DETAILS

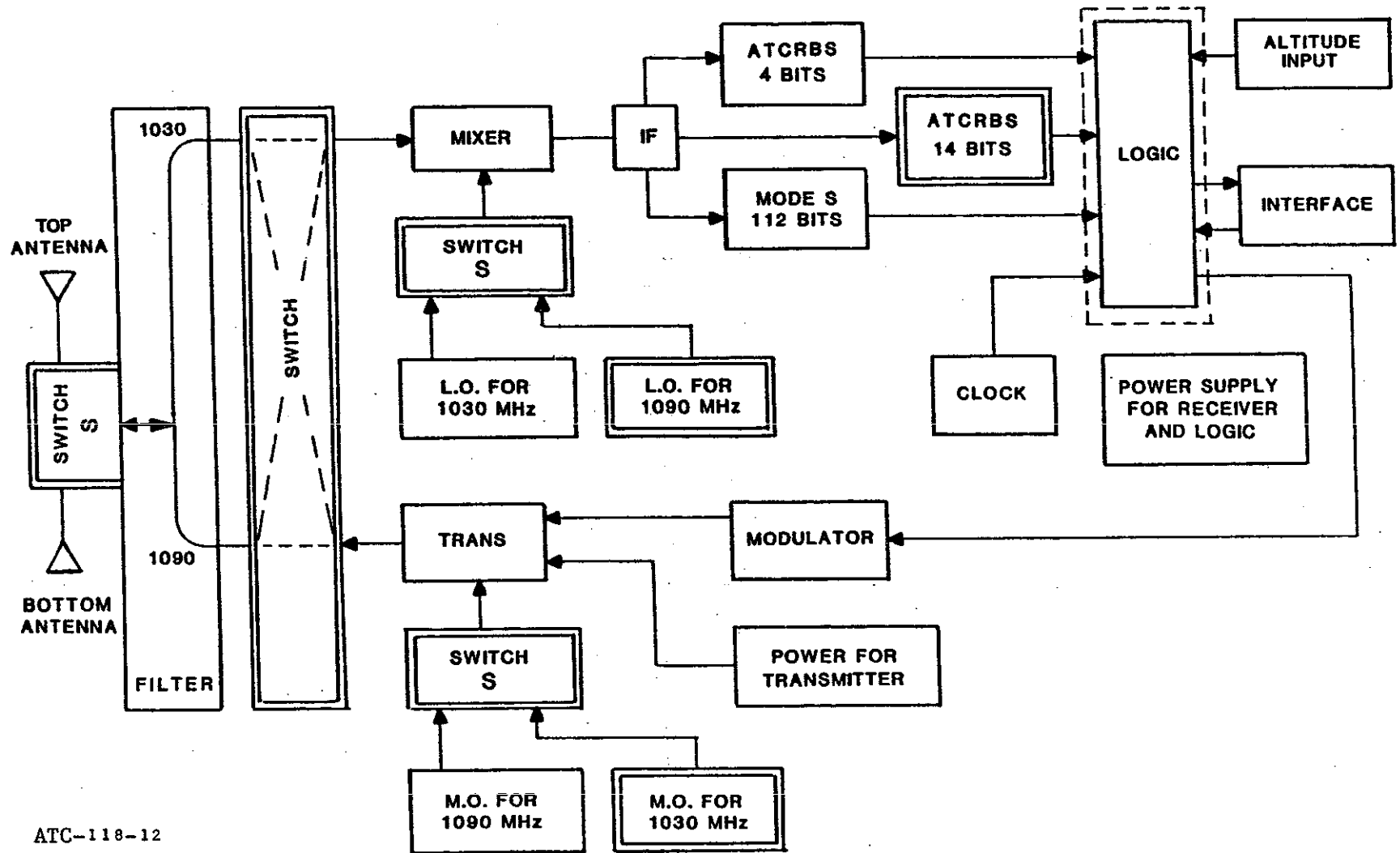

ATC-118-12

SUMMARY

Measurements indicate that a low power active TCAS I provides reliable detection of nearby aircraft. Its ability to measure range permits the use of alarm logic that should result in an acceptable rate of false alarms.

It appears that the low power active approach can be realized economically since its very low duty cycle makes it possible to time share the transponder transmitter and receiver elements.

SUMMARY

- **MEASUREMENTS INDICATE THAT ACTIVE TCAS I PROVIDES RELIABLE DETECTION OF NEARBY AIRCRAFT**

- **IT APPEARS FEASIBLE TO SHARE THE TRANSPONDER TRANSMITTER AND RECEIVER ELEMENTS WITH THE TCAS I**

ATC-118-13

REFERENCES

1. V. A. Orlando, J. D. Welch, W. H. Harman and A. R. Paradis, "TCAS I Design Guidelines", Project Report ATC-114, Lincoln Laboratory, M.I.T. (24 September 1982), FAA-RD-82-12.
2. J. D. Welch, V. A. Orlando, "Traffic Alert and Collision Avoidance System (TCAS): A Functional Overview of TCAS II", Project Report ATC-119, Lincoln Laboratory, M.I.T. (1 March 1983), DOT/FAA/PM-83/10.
3. V. A. Orlando, P. R. Drouilhet, "Mode S Beacon System: Functional Description", Project Report 42C, Lincoln Laboratory, M.I.T. (1 March 1983), DOT/FAA/PM-83/8.