

**Project Report
ATC-229**

GPS-Squitter Interference Analysis

**V.A. Orlando
W.H. Harman**

6 April 1995

Lincoln Laboratory

MASSACHUSETTS INSTITUTE OF TECHNOLOGY
LEXINGTON, MASSACHUSETTS

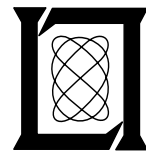

Prepared for the Federal Aviation Administration,
Washington, D.C. 20591

This document is available to the public through
the National Technical Information Service,
Springfield, VA 22161

This document is disseminated under the sponsorship of the Department of Transportation in the interest of information exchange. The United States Government assumes no liability for its contents or use thereof.

1. Report No. ATC-229	2. Government Accession No.	3. Recipient's Catalog No.	
4. Title and Subtitle GPS-Squitter Interference Analysis		5. Report Date 6 April 1995	
		6. Performing Organization Code	
7. Author(s) Vincent A. Orlando and William H. Harman III		8. Performing Organization Report No. ATC-229	
9. Performing Organization Name and Address Lincoln Laboratory, MIT P.O. Box 9108 Lexington, MA 02173-9108		10. Work Unit No. (TRAIS)	
		11. Contract or Grant No. DTFA01-93-Z-02012	
12. Sponsoring Agency Name and Address Department of Transportation Federal Aviation Administration Systems Research and Development Service Washington, DC 20591		13. Type of Report and Period Covered	
		14. Sponsoring Agency Code	
15. Supplementary Notes This report is based on studies performed at Lincoln Laboratory, a center for research operated by Massachusetts Institute of Technology under Air Force Contract F19628-95-C-0002.			
16. Abstract GPS-Squitter is a system concept that merges the capabilities of Automatic Dependent Surveillance (ADS) and the Mode S beacon radar. The result is an integrated concept for seamless surveillance and data link that permits equipped aircraft to participate in ADS and/or beacon ground environments, offering many possibilities for transition from a beacon to an ADS-based environment. Since GPS-Squitter and its associated data link share the 1030/1090-MHz beacon frequencies with other users (e.g., ground beacon radars and TCAS), there is some level of interaction between the operation of these various systems. One form of interaction is the effect on GPS-Squitter operation caused by the activities of other users. This effect, plus the effect of self-interference of GPS-Squitter operation, determines the operational capacity of GPS-Squitter. The complementary process is the effect of the GPS-Squitter operation on the other users of the beacon frequencies. This report provides an analysis of the interference to other users of the 1030/1090-MHz beacon frequencies caused by GPS-Squitter operation. The principal interference effect is channel occupancy on the beacon frequencies that prevents the reception of a desired signal by a receiver. The basis for the analysis is to estimate the channel occupancy on the beacon frequencies and its effect on the operation of victim receivers on those frequencies. The analysis is performed separately for the two frequencies. The analysis of 1030-MHz interference estimates the effect of the 1030-MHz data link activity that may be associated with GPS-Squitter (such as differential correction broadcast and two-way data link) on the operation of a transponder receiver. The 1090-MHz analysis estimates similar interference effects on (1) a terminal or en route sensor receiver and (2) a TCAS receiver. The results indicate that the operation of GPS-Squitter and its associated data link will have a negligible effect on the other users of these frequencies.			
17. Key Words Mode S Automatic Dependent Surveillance interference		18. Distribution Statement This document is available to the public through the National Technical Information Service, Springfield, VA 22161.	
19. Security Classif. (of this report) Unclassified	20. Security Classif. (of this page) Unclassified	21. No. of Pages 46	22. Price

TABLE OF CONTENTS

Abstract	i
List of Illustrations	v
List of Tables	vii
1. INTRODUCTION	1
1.1 Surveillance Applications	1
1.2 Data Link Capability	2
1.3 Interaction with Other Users	2
1.4 Interference Analysis	2
1.5 GPS-Squitter Transmission Formats	3
2. TRANSPONDER RECEIVER INTERFERENCE ANALYSIS	5
2.1 1030-MHz Broadcasts	5
2.2 1030-MHz Data Link Transmissions	6
2.3 Transponder Receiver Occupancy Summary	7
3. MODE S SENSOR RECEIVER INTERFERENCE ANALYSIS	9
3.1 Sensor Reply Processing	9
3.2 Interference Mechanisms	11
3.3 Interference Effect of Squitter Transmissions	13
3.4 Interference Effect of Data Link Transmissions	19
3.5 Sensor Receiver Summary	20
4. TCAS RECEIVER INTERFERENCE ANALYSIS	21
4.1 TCAS Interference Analysis Overview	21
4.2 Analysis Model	22
4.3 Interference Model	26
4.4 Worst Case Traffic Models	26
4.5 Definition of Fruit Scenarios	29
4.6 TCAS Interference Analysis Results	31
4.7 TCAS Receiver Summary	31
5. SUMMARY AND CONCLUSIONS	35
5.1 Summary	35
5.2 Conclusions	35
REFERENCES	37

LIST OF ILLUSTRATIONS

Figure No.		Page
1	Mode S 1030-Hz waveform.	3
2	Mode S 1090-MHz waveform.	4
3	ATCRBS/Mode S time sharing.	9
4	Main beam and omni-antenna patterns.	10
5	ATCRBS 1090-MHz reply waveform.	11
6	Power distributions of interfering receptions.	18

LIST OF TABLES

Table No.		Page
1	Mode S Transponder Occupancy for Addressed Interrogations	6
2	Movement Area Peak Aircraft Count	14
3	ATCRBS Reception Analysis Model	24
4	Short Squitter Reception Analysis Model	25
5	Long Squitter Reception Analysis Model	27
6	Interference Cases	28
7	Mode S Reply Source	28
8	Fruit Scenarios	30
9	ATCRBS Reception with Airborne Fruit	32
10	ATCRBS Reception with Airborne and Surface Fruit	32
11	Short Squitter Reception with Airborne Fruit	33
12	Short Squitter Reception with Airborne and Surface Fruit	33
13	ADS Squitter Reception (per second) with Airborne Fruit	34
14	ADS Squitter Reception (per second) with Airborne and Surface Fruit	34

1. INTRODUCTION

The International Civil Aviation Organization has defined a concept for communications, navigation, and surveillance for the next century known as the Future Air Navigation System (FANS). A cornerstone of the FANS is the increasing reliance on the use of satellite-based navigation systems such as the Global Positioning System (GPS). A second thrust of the FANS is surveillance based on the down linking of aircraft-derived satellite position information. This technique is known as Automatic Dependent Surveillance (ADS).

The general application of ADS under the FANS concept will require that all aircraft in a region of airspace be equipped with satellite navigation and some form of data link. Since such general equipage will take many years, early implementation is expected to take place in regions where other surveillance techniques are not practical, e.g., over ocean and in remote areas. Planning is currently under way for ADS to support Air Traffic Control (ATC) management of oceanic routes. Significant economic benefits are anticipated due to the reduction in separation (and the resultant capacity increase at favorable altitudes) made possible by ADS. This form of ADS connects an aircraft via a point-to-point link with the controlling oceanic ATC facility.

The application of ADS in terminal and overland areas requires a more general form of ADS in which the aircraft broadcasts its position in an omni-directional fashion. This form of ADS is known as ADS broadcast (ADS-B). The use of broadcast makes it possible for one ADS transmission to simultaneously serve the surveillance needs of multiple ground ATC and airborne collision avoidance activities.

GPS-Squitter [1] is a system concept that merges the capabilities of ADS-B and the Mode S beacon radar [2] via the randomly timed transmission of a Mode S 112-bit reply known as an extended squitter. The result is an integrated concept for seamless surveillance that permits equipped aircraft to participate in ADS-B or beacon ground environments. GPS-Squitter is a natural way to transition National Airspace System (NAS) surveillance from a ground-based beacon radar system to a GPS-ADS based environment. It also offers several other possibilities for significant benefits to the NAS.

1.1 SURVEILLANCE APPLICATIONS

The GPS-Squitter transmission can be received by omni-directional or sector-beam ground units to support ATC activities of airborne aircraft. Surveillance of aircraft on the airport surface can also be provided based on the extended squitter transmission. Special surveillance applications, such as the monitoring of closely spaced parallel runways, can also be supported.

A 56-bit squitter containing just the aircraft Mode S address is currently the basis for the Traffic Alert and Collision Avoidance System (TCAS) acquisition of Mode S equipped aircraft. The address is then used to discretely interrogate the Mode S aircraft for TCAS surveillance purposes. If TCAS aircraft are equipped for GPS-Squitter (i.e., there is an on-board GPS unit), a modification to the TCAS equipment to receive the long squitter containing the ADS data will permit TCAS to perform most of its surveillance by passively listening to squitters. The information available from GPS can also serve as the

basis for a form of TCAS that generates horizontal maneuvers as resolution advisories, in contrast to the current vertical-only maneuvers.

The squitter can also serve as the basis for Cockpit Display of Traffic Information (CDTI). In this role, the squitters would be received by nearby aircraft, as would be done for TCAS. For CDTI, the receiving aircraft has the ability to display nearby aircraft to the pilot, but no resolution advisories are generated. This mode of operation is similar to the traffic advisory portion of TCAS as provided in TCAS 1. The squitter will make it possible to provide this service to general aviation at low cost.

1.2 DATA LINK CAPABILITY

Since GPS-Squitter is based on the use of a Mode S transponder, the capability exists to provide two-way data link to equipped aircraft. The ground component of this data link can be provided by the 143 Mode S narrow-beam interrogators now being fielded, or it can be provided by omni-directional or sector-beam ground stations, including those used for surface surveillance.

1.3 INTERACTION WITH OTHER USERS

Since GPS-Squitter shares the beacon frequencies with other users (e.g., ground beacon radars and TCAS), there is some level of interaction between the operation of these various systems. One form of interaction is the effect on GPS-Squitter operation caused by the activities of other users. This effect, plus the effect of self interference of GPS-Squitter operation, determines the operational capacity of GPS-Squitter. Techniques for the estimation of GPS-Squitter capacity in various operating environments were reported elsewhere [3]. The complementary process is the effect of GPS-Squitter operation on the other users of the beacon frequencies.

1.4 INTERFERENCE ANALYSIS

This report is an analysis of the interference to other users of the 1030/1090-MHz beacon frequencies caused by GPS-Squitter operation. The principal interference effect is channel occupancy on the beacon frequencies that prevents the reception of a desired signal by a receiver on that frequency. The basis for the analysis is to estimate the channel occupancy on the beacon frequencies and its effect on the operation of victim receivers on those frequencies. The analysis is performed separately for the two frequencies.

The analysis of 1030-MHz interference estimates the effect of the 1030-MHz data link activity that may be associated with GPS-Squitter (such as differential correction broadcast and two-way data link) on the operation of a transponder receiver. The 1090-MHz analysis estimates similar interference effects on (1) a terminal or en route sensor receiver and (2) a TCAS receiver.

1.5 GPS-SQUITTER TRANSMISSION FORMATS

1.5.1 Introduction

Analysis of the interference caused by GPS-Squitter to other users of the beacon frequencies calculates channel occupancy based on the rate and length of GPS-Squitter transmissions. Definitions of their principal characteristics follow.

1.5.2 1030-MHz Waveform

The data link activity associated with GPS-Squitter uses the Mode S 112-bit transmission format on 1030 MHz. The waveform for this transmission is composed of a two-pulse preamble with a 2- μ s spacing between leading edges. The purpose of this preamble is to suppress Air Traffic Control Radar Beacon System (ATCRBS) transponders so that they do not reply to a Mode S interrogation. The remainder of the transmission is a single pulse encoded using differential phase shift keying (DPSK). The DPSK block begins with the "sync phase reversal" that determines the timing for the rest of the message block. The details of this format are presented in Figure 1.

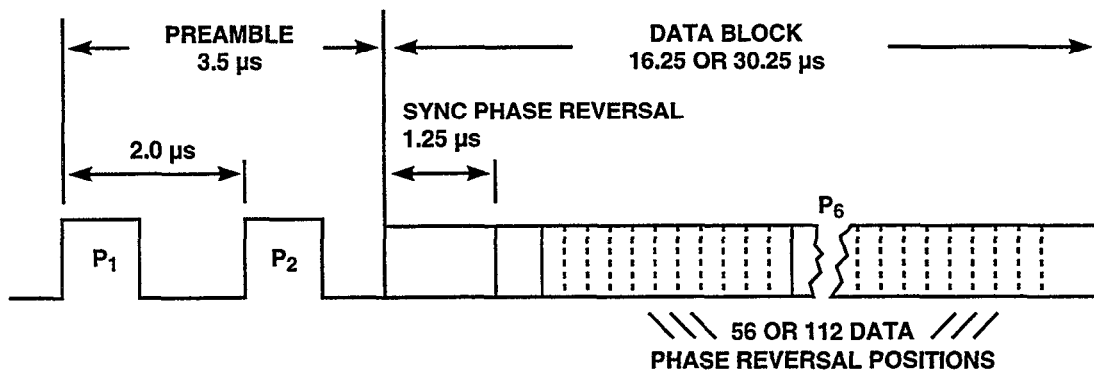

- DIFFERENTIAL PHASE SHIFT KEYING (DPSK) MODULATION
- DATA RATE 4 Mb/s

Figure 1. Mode S 1030-MHz waveform.

1.5.3 1090-MHz Waveform

GPS-Squitter uses the Mode S 112-bit transmission format on 1090 MHz. The waveform for this transmission begins with a four-pulse preamble and is followed by message data encoded using pulse position modulation (PPM). The PPM encoding supports correct message data decoding in the presence of interference provided the amplitude of the interfering transmission is lower than the Mode S transmission being decoded. The details of this format are presented in Figure 2.

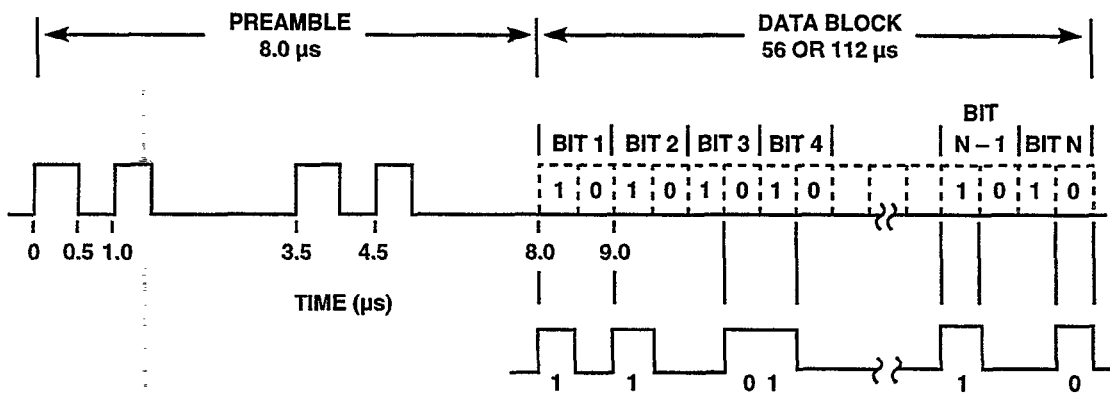

- PULSE POSITION MODULATION (PPM)
- DATA RATE 1 Mb/s

Figure 2. Mode S 1090-MHz waveform.

2. TRANSPONDER RECEIVER INTERFERENCE ANALYSIS

This part of the study examines the interference implications of using GPS-Squitter ground stations for broadcast or two-way data link service, in addition to their primary function as squitter receiving stations.

GPS-Squitter activity on 1030 MHz has two components:

- Differential corrections broadcast for GPS (DGPS) to approaching and surface aircraft
- Interrogations to airborne and surface aircraft for two-way data link activity.

2.1 1030-MHZ BROADCASTS

2.1.1 Broadcast Effect on Transponder Receiver

As shown in Figure 1, a 112-bit Mode S interrogation is 33.75 μ s in length. However, the effective channel occupancy of a Mode S interrogation must account for the occupancy time of this interrogation on transponders receiving the transmission.

An ATCRBS transponder will detect the P1/P2 preamble and be suppressed for a maximum of 45 μ s. A Mode S transponder will receive and process the interrogation and be unavailable to receive another transmission for 45 μ s.

2.1.2 Broadcasts to Airborne Aircraft

DGPS correction broadcasts to approaching aircraft will be needed in support of GPS-based category 1 approach operations. Reliable operation is intended out to a range of 20 nmi. A transmit power of 250 W is required for adequate link margin at 20 nmi. This power will affect transponders out to a range of about 100 nmi.

Studies in support of the Radio Technical Commission for Aeronautics (RTCA) Task Force 2 [4] concluded that the transfer of this information would require seven 112-bit Mode S broadcasts per second for each airport served based upon the worst case assumption of 12 satellites in view. The worst-case Task Force 2 model required operation with up to eight airports within signal range.

Channel occupancy for each broadcast transmission is 45 μ s, leading to a channel occupancy of 0.0315% per airport, based on seven broadcasts per second. The set of eight airports has a total channel occupancy of 0.252%.

2.1.3 Broadcasts to Surface Aircraft

DGPS broadcast to surface aircraft will be needed in support of ADS-based surface surveillance. Reliable operation is required to 4 nmi. A transmit power of 10 W will provide adequate link margin at

4 nmi as demonstrated by measurements at Logan Airport [5]. These transmissions will have an effective range of 20 nmi.

As seen at Logan Airport, excellent operation is achieved by transmitting the 7 DGPS broadcasts from each of the four ground stations once per second leads to a total transmission rate of 28 broadcasts per second for a channel occupancy of 0.126% per airport.

2.2 1030-MHZ DATA LINK TRANSMISSIONS

2.2.1 Data Link Effect on Transponder Receiver

Receiver occupancy for ATCRBS transponders is the same for a Mode S two-way data link interrogation as it is for a Mode S broadcast, i.e., 45 μ s.

Receiver occupancy for Mode S transponder receivers is defined by the following considerations. A Mode S interrogation received by the Mode S transponder on the addressed aircraft will result in the acceptance and processing of this interrogation, the transmission of a reply on 1090 MHz followed by a dead time before the transponder is available for another interrogation. The total occupancy time for this activity is 321.75 or 377.75 μ s for the case of a short or long Mode S reply, respectively, as shown in Table 1. Very few interrogations are received by any one transponder. The majority of the interference effect caused by two-way data link operation is the time a transponder spends decoding interrogations intended for other aircraft. This occupancy time is also the same as the time to process a Mode S broadcast, i.e., 45 μ s.

TABLE 1

Mode S Transponder Occupancy for Addressed Interrogations

EVENT	SHORT REPLY	LONG REPLY
	(μ S)	(μ S)
Detect interrogation	4.75	4.75
Turnaround Delay	128	128
Reply	64	120
Dead Time	125	125
TOTAL	321.75	377.75

2.2.2 Data Link Transmissions to Airborne Aircraft

This study assumes that two-way data link service would be provided by each GPS-Squitter ground station out to its maximum operating range. To account for the lower receiver sensitivity of a transponder compared with a GPS-Squitter station, a transmit power of 1.5 kW would be used. These transmissions have an effective interference range of 250 nmi.

The use of GPS-Squitter ground stations to provide two-way data link service was described in the GPS-Squitter capacity report [3]. The maximum data link capacity was defined in terms of a 1% channel occupancy of the 1030-MHz channel within any region of airspace, meaning that multiple ground stations operating within signal range will have to share this budget.

2.2.3 Data Link Transmissions to Surface Aircraft

The operating range for surface aircraft is 4 nmi, the same operating range used for surface DGPS broadcast. A transmit power of 10 W provides reliable coverage to 4 nmi and an interference range of 20 nmi.

While no specific two-way Mode S data link applications have as yet been defined for the airport surface, it is expected that the this surface data link will be used to transfer alerts and commands generated by the same airport surface automation systems that use the ADS-based surveillance provided by the surface GPS-Squitter stations. Since no model of this activity exists, a rate of 10 interrogations per second has been assumed and yields a channel occupancy of 0.045% per airport.

2.3 TRANSPONDER RECEIVER OCCUPANCY SUMMARY

The combined effect of airborne and surface operation for broadcast and two-way data link is summarized as follows:

Approach DGPS	0.0315%
Surface DGPS	0.126%
Airborne data link	1.000%
Surface data link	0.045%

A victim transponder in the RTCA Task Force 2 eight-airport scenario would be affected by approach DGPS transmissions from eight terminals (because of the 100-nmi effective range) but would only receive surface transmissions from about two terminals because of the lower transmit power. Airborne two-way data link activity would be a factor only in low density airspace, because Mode S rotating-beam interrogators would provide this service in high density airspace.

The total occupancy is

Approach DGPS (x8)	0.252%
Surface DGPS (x2)	0.252%
Airborne data link	1.000%
Surface data link (x2)	0.090%
<hr/>	
Total for low density airspace	1.594%
Total for high density airspace	0.594%

3. MODE S SENSOR RECEIVER INTERFERENCE ANALYSIS

3.1 SENSOR REPLY PROCESSING

3.1.1 Overview

A Mode S sensor provides surveillance coverage for Mode S as well as ATCRBS transponders. As shown in Figure 3, these activities are performed by sharing the time line between ATCRBS and Mode S processing. For ATCRBS, an interrogation is transmitted followed by a listening interval appropriate for the maximum range of the sensor. The same approach is used for Mode S interrogations that elicit Mode S all-call replies, through which the sensor acquires the address of a new aircraft.

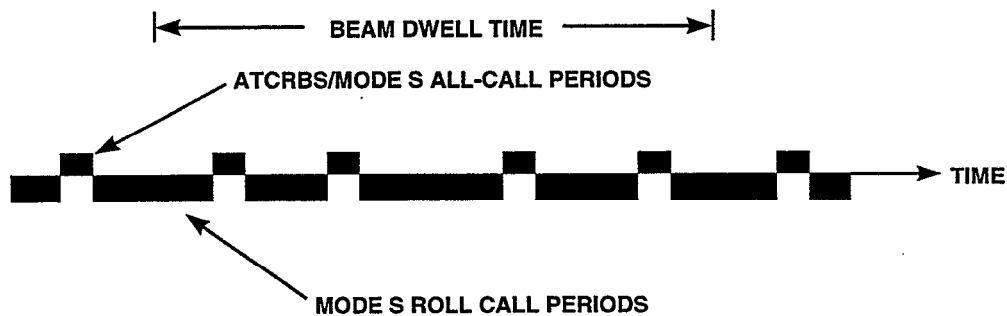

Figure 3. ATCRBS/Mode S time sharing.

Mode S reply processing uses inputs from the directional pattern as well as an omni-channel, as shown in Figure 4. The omni-channel flags receptions that appear in the directional channel due to the antenna sidelobes. The gain of the omni-channel is set to be greater than that of the highest sidelobe.

A brief overview of sensor reply processing is given in the following paragraphs to explain the possible effects of interference on sensor performance. A more detailed description of this function is given in Orlando and Drouilhet [2].

Mode S Reply Processing. As shown in Figure 2, Mode S replies are composed of a four-pulse preamble followed by a 56- or 112-bit data block coded using pulse position modulation. For the reception of all-call replies, the Mode S reply processor is enabled after the interrogation for a time period that is determined by the sensor maximum range. For addressed interrogations, the reply processor is enabled slightly before the expected reply reception time, based upon the aircraft range history.

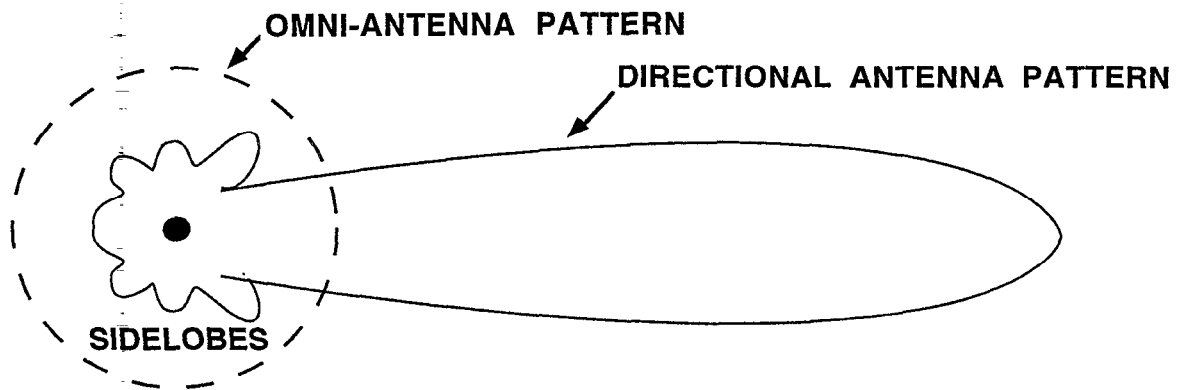

Figure 4. Main beam and omni-antenna patterns.

Once a reply preamble is detected, the reply processor samples the reply pulses to form an estimate of the bit value (ONE or ZERO) for each data bit. The bit value is determined by sampling both chip halves of the pulse position encoded data, and declaring the half with the higher value to be the bit value, a ONE for the leading chip and a ZERO for the trailing chip. A confidence estimate (high or low) is determined for each bit position to flag the presence of possible interference during the decoding of that bit. An example of a low confidence condition is the presence of energy above threshold in both chip halves indicating the presence of an overlapping reply.

Mode S replies include an address/parity field that contains parity overlaid with the aircraft address. After decoding, a reply with no errors will leave a zero value in the address/parity field. This value is called the error syndrome. The Mode S reply processor can perform error correction on replies received with a non-zero error syndrome. The error correction can normally correct for the errors caused by one overlapping ATCRBS reply. Limits are placed on the ability to attempt error correction based upon the number and extent of low confidence bits to control the occurrence of undetected errors caused by error correction.

For error-free or error-corrected replies, the output of the Mode S reply processor is a bit vector giving estimates of the 56- or 112-bit data bits of the reply. Otherwise, the reply processor outputs an indication that a reply was received that could not be error corrected.

ATCRBS Reply Processing. ATCRBS replies are composed of 2 framing pulses and up to 12 pulses (the X pulse position is not used) as shown in Figure 5. The ATCRBS reply processor is the sensor function that decodes the received ATCRBS replies. It looks for framing pulses spaced 20.3 μ s that define the presence of an ATCRBS reply. When it detects a pair of framing pulses, it estimates the value of each bit position in the reply by sampling the received wave form and declares each bit to be a ONE or a ZERO, depending on the detected amplitude. Provision is made for degarbling overlapping replies.

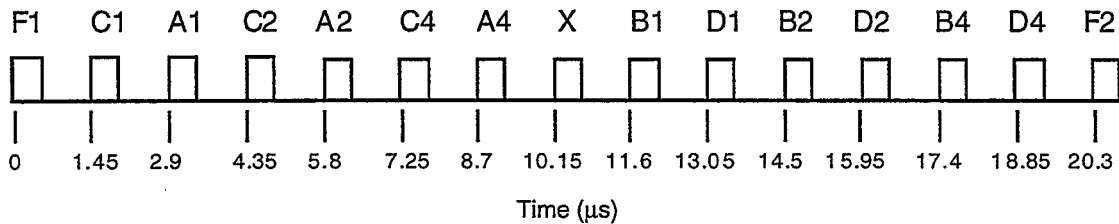

Figure 5. ATCRBS 1090-MHz reply waveform.

The output of the reply processor for each reply is a bit vector of estimates of each of the bit declarations, plus a bit vector giving confidence levels (low or high) for each bit declaration. The confidence level for each bit declaration is based upon conditions that indicate the presence of interference during the reception of that bit. An example is a longer than normal pulse width indicating the presence of an overlapping reply. Confidence bits are used in the assembling of a single scan report containing the high confidence bit estimates from the four or more replies that are received during a beam dwell. Confidence bits are also used in scan-to-scan correlation where agreement is required for pair-wise comparison of the high confidence bit positions of the scan report with corresponding data items of the track file.

3.2 INTERFERENCE MECHANISMS

3.2.1 Main Beam Reception of GPS-Squitter Transmissions

Mode S Reply Processing: Reply Processor Capture. Low amplitude GPS-Squitter transmissions are not likely to cause bit declaration errors or confidence errors; however, these transmissions may capture the reply processor so that it is busy when the desired reply arrives. This latter effect is more applicable to the receipt of all-call replies (where the reply processor is enabled for a range sweep of a millisecond or more) than to the case of replies to addressed interrogations (where the reply processor is enabled for a number of microseconds before the desired reply is expected).

Mode S Reply Processing: Bit Declaration Errors. Main beam reception of GPS-Squitter transmissions (pseudo-random squitters or replies to data link interrogations) received via the main beam can overlap a desired reply. If the amplitude of the GPS-Squitter reception is greater than or equal to the desired reply, bit errors may occur during the decoding process.

Mode S Reply Processing: Confidence Errors. If the amplitude of the squitter transmission is less than the desired reply, bit declaration errors normally will not occur, but low confidence assignments may be made to correctly decoded bits. Errors in confidence flagging will not affect the reception of an error-free reply; however, confidence errors may prevent error correction that would have been possible without the additional low confidence bits caused by the interfering transmission.

ATCRBS Reply Processing: Reply Processor Capture. A Mode S reply can lead to the generation of a number of ATCRBS bracket detections due to the pulse spacing of a Mode S reply. For

this reason, Mode S interrogators have a Mode S preamble detector to disable the ATCRBS reply processor for the duration of a Mode S reply received via the main beam. This is the dominant interference effect caused by GPS-Squitter transmissions on ATCRBS reception.

ATCRBS Reply Processing: Bit Declaration Errors. Main beam receptions of GPS-Squitter transmissions that do not trigger the preamble detector (due to an overlapping ATCRBS reply) may cause ATCRBS bit declaration errors. The most likely error is to convert a pulse amplitude modulation encoded ZERO into a ONE, since the ZERO is represented by an absence of energy at a bit position.

ATCRBS Reply Processing: Confidence Errors. Lower level GPS-Squitter transmissions that do not cause bit errors may cause confidence errors through mechanisms such as causing a longer than standard length pulse when the interference is combined with the desired signal. Confidence errors can lead to errors when combining replies to form a scan report, since a correctly received pulse flagged as low confidence may not be selected for inclusion in the scan report. This is only a factor if that pulse was not received with high confidence in any of the same mode replies for that scan.

3.2.2 Sidelobe and Omni-Reception of GPS-Squitter Transmissions

Mode S Reply Processing: Reply Processor Capture is not a factor for sidelobe receptions, since sidelobe replies will be flagged as omni-receptions, i.e., not from the main beam. The Mode S reply processor will only trigger on the preamble of a reply labeled as having been received by the main beam.

Mode S Reply Processing: Bit Declaration Errors. Sidelobe reception of GPS-Squitter transmissions can cause the same bit declaration errors as main beam receptions. Due to the lower gain of the sidelobes compared with the main beam (on average below -40 dB), however, transmissions that cause bit errors must be from a much shorter range than the aircraft transmitting the desired reply. The 30-dB difference in gain is equivalent to a range ratio of 30. For an aircraft under surveillance at 60 nmi, a GPS-Squitter aircraft near enough to cause interference through the sidelobes must be at a range of about 2 nmi or less. This range ratio effect greatly decreases the apparent rate of GPS-Squitter transmissions capable of causing bit errors because only a fraction of the aircraft in coverage will be in the sidelobe region.

Mode S Reply Processing: Confidence Errors can occur with sidelobe receptions in the same manner as for main beam reception; however, the effective rate of occurrence is much lower due to the range ratio effect.

ATCRBS Reply Processing: Reply Processor Capture is not a factor for sidelobe receptions, since sidelobe replies will be flagged as omni-receptions. The ATCRBS reply processor will only trigger on a brackets labeled as originating from the main beam.

ATCRBS Reply Processing: Bit Declaration Errors can be caused by sidelobe receptions for ATCRBS replies but at a lower rate because of the range ratio effect described previously.

ATCRBS Reply Processing: Confidence Errors can occur, but at a lower rate due to the range ratio effect.

3.2.3 Omni-Only Reception of GPS-Squitter Transmissions

All sidelobe receptions are also received by the omni-channel and because it has a higher antenna gain than the sidelobes, replies may be received via the omni-channel that do not appear in the main beam channel.

Mode S Reply Processing: Reply Processor Capture is not possible due to these transmissions because they do not appear in the main beam channel.

Mode S Reply Processing: Bit Declaration Errors cannot be caused by these transmissions because they do not result in reception via the main beam channel.

Mode S Reply Processing: Confidence Errors may be caused by an omni-reception of a GPS-Squitter transmission, which may cause a correctly declared main beam bit declaration to be labeled low confidence (an omni-reception will be indicated.) The possible rate of this effect is somewhat higher than for the sidelobe case due to the greater effective range of the omni-compared with the sidelobe receptions.

ATCRBS Reply Processing. The effects of reply capture, bit errors and confidence errors are qualitatively the same as for Mode S reception.

3.3 INTERFERENCE EFFECT OF SQUITTER TRANSMISSIONS

3.3.1 Squitter Characteristics

Airborne Aircraft Squitter Rate. While airborne, GPS-Squitter transponders transmit 112-bit Mode S squitter transmissions twice per 1 s for ADS-B and once per 5 s for aircraft identity broadcast, yielding an average of 2.2, 112-bit squitters per second per aircraft.

Surface Aircraft Squitter Rate. On the surface, GPS-Squitter transponders transmit at the same rate (2.2 per second) while in motion. When the aircraft stops, the ADS-B is transmitted once per 5 s and the identity broadcast update rate is reduced to once per 10 s. Transmission at the higher rate is resumed immediately if motion is detected on the aircraft. Provision is also made for the ground to command the aircraft to remain at the higher rate regardless of motion state when the aircraft is in a critical position (e.g., stopped at the entrance to an active runway).

A recent survey conducted by Lincoln Laboratory of the top 10 airports in the United States indicates an instantaneous peak movement area count of 100 or less, as shown in Table 2. These are peak values that will only be reached only in very rare overload conditions such as severe weather. In these cases, large numbers of aircraft would be queued and the percentage of stationary aircraft would increase as the surface count increased. Based upon this effect, it is expected that the worst case peak squitter rate at a high density terminal will be no more than 220 squitters per second. This is the rate that would be received from 100 moving aircraft, using the preceding algorithm.

Squitter Power Level. The same squitter transmit power is used when airborne or on the surface—250 W \pm 3 dB for an air carrier transponder and 250 W + 3, - 5.5 dB for a general aviation transponder (minimum power of 70 W).

TABLE 2

Movement Area Peak Aircraft Count

RANK	CITY	AIRPORT	INSTANEOUS PEAK
1	CHICAGO	ORD	100
2	DALLAS/FT WORTH	DFW	100
3	LOS ANGELES	LAX	60
4	ATLANTA	ATL	60
5	DENVER	DEN	24
6	MIAMI	MIA	75
7	BOSTON	BOS	30
8	PHOENIX	PHX	40
9	CHARLOTTE	CLT	36
10	ST. LOUIS	STL	36

3.3.2 Squitter Effect on Sensor Receiver

Squitters from Airborne Aircraft. GPS-Squitters from airborne aircraft can interfere with main-beam receptions if they overlap the desired reply. The principal interference effect is due to airborne GPS-Squitter aircraft that are in the main beam together with the aircraft that is being interrogated by the sensor. One way to assess this interference effect is to estimate the channel occupancy caused by 1090-MHz squitter activity from the perspective of the sensor receiver. This occupancy is calculated by estimating the maximum number of aircraft that can be in the antenna beam, and then determining the channel occupancy represented by the squitters generated by these aircraft.

The Mode S sensor specification [6] defines a maximum traffic load of 32 aircraft in a 2.4-deg antenna beam. The maximum total capacity of a Mode S sensor is specified to be 700 aircraft, which corresponds to an average beam dwell loading of 4.7 aircraft. A reasonable worst-case operational traffic load is estimated to be 20 aircraft in the main beam, or a peaking of about four times the average value.

Twenty aircraft in the main beam will generate a total of 44 long squitters per second, corresponding to a channel occupancy of 0.53%.

Squitters from Surface Aircraft: Upper Bound. Aircraft on the airport surface transmitting GPS-Squitters are close enough to a terminal radar at the same airport to be received via the antenna sidelobes in many cases. A simple calculation provides an upper bound for this effect. Suppose all the surface aircraft are near enough to be received via sidelobes and the total rate of squitter transmissions is 220 per second (a conservative value noted earlier). The time occupancy of these receptions is

$$\text{Occupancy} = (\text{rate}) \times (\text{time}) = (220/\text{s}) \times (120 \mu\text{s}) = 0.026$$

If the desired signal being received is a Mode S reply of 64- μs duration, then (using the Poisson modeling technique [3]) the probability of overlapping interference is

$$P(\text{interference}) = 1 - \exp[-(220/\text{s}) \times (120 \mu\text{s} + 64 \mu\text{s})] = 0.040$$

For those cases in which the desired replies from a Mode S target in track are received incorrectly, the radar will reinterrogate the aircraft. Given a miss probability of 0.040, the reinterrogation rate would be

$$\text{Reinterrogation rate} = \frac{1}{P(\text{interference})} = 1.042$$

which is quite small.

Squitters from Surface Aircraft: Long-Range Target. For this upper bound it was assumed that all squitters from aircraft on the surface are received strongly enough to cause errors. The following calculation is more detailed and includes the power attenuation of the antenna sidelobes. For an airborne aircraft under surveillance, the desired signal is received via the antenna main beam, whereas most of the surface aircraft are received via the sidelobes. For the 5-ft open array antenna, the average sidelobe level is approximately 40 dB relative to the main beam. On the other hand, the range difference between a target aircraft and an interfering aircraft boosts the interference power. Putting the antenna gain effect together with the range effect and allowing for fading yields the following interference-to-signal power ratio:

Range effect, $20 \log(60 \text{ nmi}/1 \text{ nmi})$	+36	dB
Antenna sidelobes	-40	dB
Fade of signal	10	dB
<hr/>		
Net I/S	+6	dB

These values apply to a worst-case target at a range of 60 nmi having a power fade of 10 dB. For this case, the average interfering reply is stronger than the desired signal. The conclusion is that most of the interference receptions are strong enough to cause errors and reinterrogation. Thus the reinterrogation rate is about 1.04 for this worst-case target.

Squitters from Surface Aircraft: Typical Targets. In more typical cases, the range to the target is less than 60 nmi, and there is no fade of the signal relative to the interference. For example, for a target at 30 nmi without fading, the average interference-to-signal ratio is about -10 dB, which is weak enough that typically no errors are produced when interference overlaps the data block of a desired signal.

Although the average interference is substantially weaker than the signal, some percentage of the receptions is strong enough to cause errors. Also, receptions much weaker than the signal can capture the reply processor as described in *Mode S Processing*.

Squitters from Surface Aircraft: Simulation Description. To obtain quantitative results for the overall conditions, a simple Monte Carlo simulation has been constructed. The ranges of the target aircraft are modeled as uniformly distributed between zero and 60 nmi. The ranges of the surface aircraft contributing long squitters are modeled by uniformly distributing them within a 2 nmi by 2nmi-area with the radar located at the midpoint of one side. Antenna sidelobes are modeled as -40 ± 10 dB. Power fading of the signal relative to the interfering receptions is modeled as extending over ± 10 dB with a uniform distribution over this range. Interfering receptions stronger than -6 dB relative to the signal are considered to cause a missed reply. The effect of reply processor capture by a weak squitter reception received earlier than the signal is also considered. In this case, if the interference reception is stronger than -20 dB relative to the nominal signal power, then it is considered to capture the reply processor and cause the signal to be missed.

Squitters from Surface Aircraft: Mode S Simulation Results. The simulation results indicate the distribution of the values of received interference power relative to the signal. These distributions are plotted in Figure 6 for both the case of the long range target in a fade and the overall case of all targets together. For the case of all targets, the simulation results can be summarized as follows:

Capture	$I/S(\text{nom}) > -20$ dB	76% of squitters are stronger
Bit errors	$I/S > -6$ dB	30% of squitters are stronger

It is seen that only a minority of the received squitters are strong enough to interfere with the data block, whereas the majority are strong enough to capture the reply processor if they arrive before the signal. Using these results with the corresponding overlap probabilities, yields:

	Overlap Probability	Fraction Causing Misses	Miss Probability
All-call mode:			
Capture	0.026	0.76	0.020
Bit errors	0.014	0.30	0.004
Together	0.040		0.024
Discrete mode:			
Capture	0.001	0.76	0.001
Bit errors	0.039	0.30	0.012
Together	0.040		0.013

The reason that the discrete mode experiences a smaller effect is that the reply processor is enabled for only a short time (5 μs) before the expected reception so that the capture effect is smaller.

The total effect of this interference is quite small. In the all-call mode, the target aircraft transmits approximately four to six replies in each scan. The basic output needed from this mode is a single all-call reply for detection of the presence of the aircraft, and determination of its address and approximate location. Thus the 2.4% missed reply probability per reply yields a missed scan report of 0.00003%, assuming four all-call replies per scan. The multiple replies in each scan provide a capability to perform effectively in an environment many times more severe.

In the discrete mode, the radar automatically reinterrogates as necessary so that the only effect is the reinterrogation rate. Given that P(miss) = 0.013 for the collection of all targets, it follows that the overall reinterrogation rate is 1.013. This effect is very small, well within the intended operating environment of a Mode S radar.

Finally, it should be noted that this calculation applies to a very conservative model for the number of aircraft on the surface transmitting squitters at the full rate, 100 aircraft times 2.2/s = 220 squitters per second. This rate may be exaggerated by a factor of 2 or 3 relative to actual occurrences even at the largest airports in the worst weather conditions.

Squitters from Surface Aircraft: Mode A/C Simulation Results. For aircraft equipped with Mode A/C transponders, surveillance is carried out in Mode A (identity) and Mode C (altitude). Because the Mode A/C replies are shorter than Mode S replies, the overlap probability is slightly less:

$$P(\text{overlap}) = 1 - \exp[-(220/s) \times (120 \mu\text{s} + 20.3 \mu\text{s})] = 0.030$$

The interference-to-signal power ratios are the same as in the preceding calculations (Figure 6), but there is a difference in the tolerance to interference: the desired Mode A/C replies cannot tolerate Mode S interference unless it is substantially weaker. A suitable model is that for interference stronger than -20 dB relative to the nominal reception (a function of range), the interference causes the reply to be missed; for weaker interference the reply is received correctly. Using this model together with the power distributions given earlier, it follows that the percentages of squitters that interfere are:

Long range target (60 nmi, 10-dB fade)	100% of squitters
Typical targets	76% of squitters

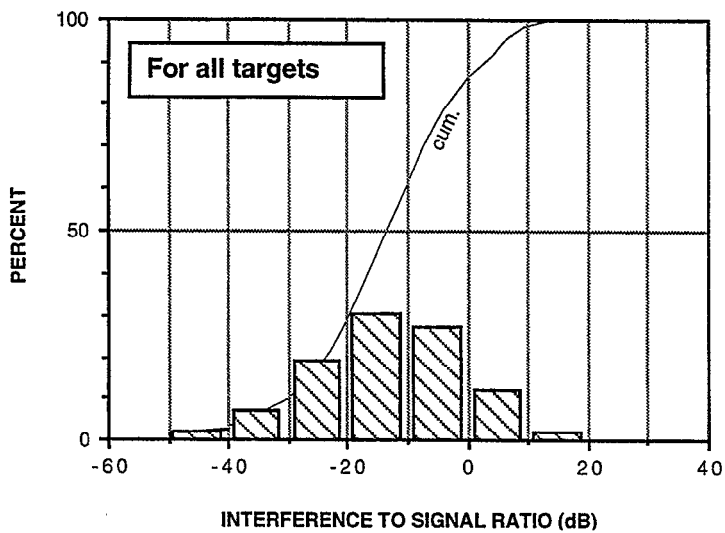
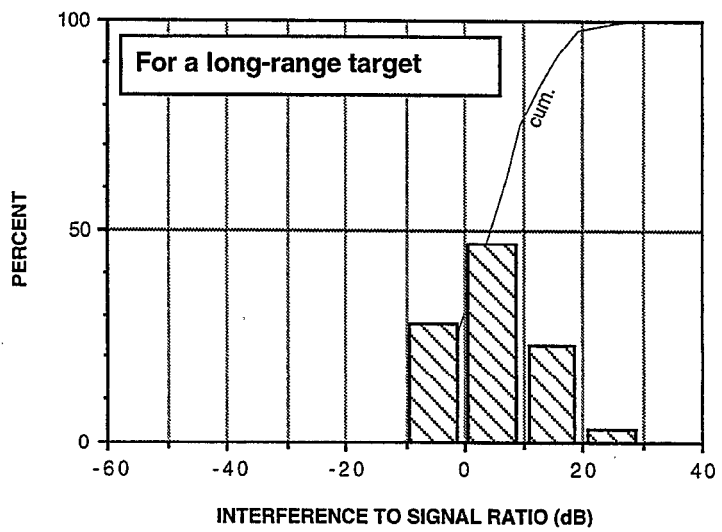

Figure 6. Power distributions of interfering receptions.

Combining these values with the calculated overlap probability yields the probability that a desired Mode A/C reply is missed as consequence of interference from squitters:

$$P(\text{miss}) = \begin{array}{ll} 0.031 & \text{long-range target} \\ 0.024 & \text{typical targets} \end{array}$$

The radar generates a target report in each scan by combining the information from the multiple replies received. To operate in a background of interference, the system is designed to provide a greater number of replies on average than the minimum number needed. Specifically, for a Mode S sensor the minimum needed to update a track with a new report of position, identity, and altitude, is one Mode A reply and one Mode C reply. The average number provided in the absence of interference is six for typical targets and four for a long-range faded target. Under these conditions the probability of report can be calculated as follows:

$$P(\text{report}) = \begin{array}{ll} [1 - P(\text{miss})^2]^2 & \text{long-range target} \\ [1 - P(\text{miss})^3]^2 & \text{typical targets} \end{array}$$

Therefore, the probability of report as limited by squitter interference is

$$P(\text{report}) = \begin{array}{ll} 0.998 & \text{long-range target} \\ 0.999 & \text{typical targets} \end{array}$$

These calculated levels of performance are very high, higher, in fact, than the practical operational performance of a sensor as affected by signal power fading and multipath. Note also that an operational sensor will be subjected to interference from other sources in addition to the amounts included here. The conclusion that can be drawn from these results is that the sensor is tolerant to interferences of this type and amount, and that the effects of interference from squitters are not a significant degradation relative to normal surveillance limitations.

3.4 INTERFERENCE EFFECT OF DATA LINK TRANSMISSIONS

3.4.1 Data Link Reply Characteristics

Airborne Aircraft Data Link Reply Rate. As indicated elsewhere [3], if GPS-Squitter stations are used for two-way data link service, this activity would be limited to low density airspace. Mode S rotating-beam sensors will provide this data link service in high density airspace. Certain data link applications that require a shorter delivery delay than can be provided by the Mode S sensors may be made available through the GPS-Squitter stations, which would be a very low rate, estimated to be no more than 10 transactions per second. Each transaction would elicit a long or short Mode S reply.

Surface Aircraft Data Link Reply Rate. GPS-Squitter two-way data link activity on the airport surface may be used to deliver commands and alerts generated by a future surface automation system, which is also estimated to be no more than 10 transactions per second. The resulting 10 Mode S replies per second would only be a factor for a terminal Mode S sensor receiver.

Reply Power Level. The same transmit power is used as for the squitter—250 W for an air carrier transponder and 85 W for a general aviation transponder.

3.4.2 Data Link Reply Effect on Sensor Receiver

A worst-case condition for Mode S replies to GPS-Squitter interrogations is that they are long replies received in the main beam. The 10 replies elicited from airborne aircraft represent a channel occupancy of 0.12%. This occupancy is applicable to en route or terminal sensors. An additional 0.12% occupancy is applicable to terminal Mode S sensors due to the surface data link activity.

3.5 SENSOR RECEIVER SUMMARY

The following effects on the Mode S sensor receiver are due to GPS-Squitter activity :

- Airborne squitters—0.53% occupancy
- Surface squitters (terminal only)
 - Maximum worst-case miss probability of
 - 0.00003% for a Mode S all-call report
 - 0.2% for an ATRBS report
 - Maximum worst-case reinterrogation rate of
 - 1.3% for a discrete Mode S reply
- Airborne data link— 0.12% occupancy
- Surface data link —0.12% occupancy (terminal only)

This level of squitter channel occupancy will have a negligible effect on sensor operation.

4. TCAS RECEIVER INTERFERENCE ANALYSIS

4.1 TCAS INTERFERENCE ANALYSIS OVERVIEW

4.1.1 Approach

Because TCAS uses an omni-directional or broad sector beam antenna, it operates with a higher level of channel interference than the narrow beam Mode S sensor. Reply performance is a function of reply length and signal characteristics. For this reason, an accurate assessment of GPS-Squitter operation on TCAS requires that the probability of reception be estimated for each reply type received by TCAS. For the current TCAS, this reception includes ATCRBS and short Mode S squitter transmissions. A future version of TCAS incorporating passive GPS-Squitter surveillance, will also receive the long Mode S squitter.

The probability of TCAS receiving each reply type is estimated using the Poisson modeling technique [3]. Estimates are made for environments with and without GPS-Squitter operation. A comparison of these two results gives a quantitative estimate of GPS-Squitter activity on TCAS operation.

4.1.2 Interference Environments

A basic interference model is defined that is intended to represent a high level of Mode S activity, and to span the range of ATCRBS reply rates. Three interference environment cases are defined for the different ATCRBS reply rates.

4.1.3 Effect of Surface Aircraft

Two sets of interference environments are analyzed. One set contains only transmissions from airborne aircraft and is representative of most airspace. The second set includes the effects of transmissions from airborne and a large number of surface aircraft and is therefore representative of airspace near a major terminal.

4.1.4 GPS-Squitter Equipage

Three levels of GPS-Squitter equipage are analyzed—0%, 50%, and 100%. In each case, the percent equipage applies to the total number of aircraft and to the total number of TCAS equipped for passive reception of GPS-Squitter data. For example, for the middle equipage case, 50% of the aircraft are assumed to transmitting long squitters and 50% of the TCAS aircraft are assumed to take advantage of the passive surveillance available for the equipped aircraft. The zero percent equipage level corresponds to the current environment.

4.1.5 Data Link Activity

It is assumed that operation of a GPS-Squitter ground station results in additional replies elicited as a result of two-way data link activity. As explained in Section 3.4.1, this data link activity will not be performed for airborne aircraft in high density environments because the Mode S production sensors will provide this service. The only GPS-Squitter data link activity relevant to the high densities that are the focus of this interference analysis is two-way data link activity to aircraft on the airport surface or for applications for airborne aircraft that require a faster delivery than is possible with the rotating beam sensors. This activity is estimated (Section 3.4.1) to be at a level of no more than 10 transactions per second. This low rate of additional Mode S replies would have a negligible effect on this analysis and will be ignored.

4.2 ANALYSIS MODEL

4.2.1 Overview

The technique used to estimate GPS-Squitter surveillance performance is based upon the Poisson probability model for the reception of transponder transmissions. This technique is the standard for estimating the probability of the arrival of randomly generated events in a listening time window.

4.2.2 Interference Mechanism

Mode S transponders transmit squitters on 1090 MHz. Because this frequency is reserved principally for beacon radar use, it is shared with ATCRBS activities. The interference events of interest then are ATCRBS replies and short (56-bit) and long (112-bit) Mode S replies. The length for each reply type follows:

ATCRBS	20.3 μ s
56-bit Mode S	64 μ s
112-bit Mode S	120 μ s

The interference effect of an individual reply is a function of its length. Thus the analysis must treat the effect of each reply separately.

4.2.3 Analysis Technique for ATCRBS Reply Reception

The Poisson model is applied separately to each interfering reply type to calculate the probability of an interfering reply in the 20.3- μ s listening window needed to receive an ATCRBS reply.

For the long Mode S format, the probability of receiving zero replies in a 140.3- μ s window is calculated. The window of 140.3- μ s is used, since an ATCRBS reply may not be correctly received if any part of the reply is overlapped with a long Mode S fruit reply. Thus the window length is the sum of the lengths of the desired and interfering replies. The calculation for the short Mode S format is similar, except that a window of 84.3 μ s accounts for the length of the short reply.

The ATCRBS interference effect is estimated by calculating the probability of zero, plus 0.5 times the probability of one ATCRBS in a 40.6- μ s window. ATCRBS replies have 0.45- μ s pulses on 1.35- μ s leading edges, so one overlapping ATCRBS reply may not prevent reception since the decoder can handle interleaved pulses. The individual probabilities are then multiplied to obtain the probability of successful squitter reception with the assumed fruit rate for each of the reply types. The details of the technique used for the estimation of ATCRBS reply reception probability are presented in Table 3.

4.2.4 Analysis Technique for Short Squitter Reception

The Poisson model is applied separately to each interfering reply type to calculate the probability of an interfering reply in the 64- μ s listening window needed to receive a short squitter.

For the long Mode S format, the probability of receiving zero replies in a 184- μ sec window is calculated. The window of 184 μ s is used, because a short squitter may not be correctly received if any part of the squitter is overlapped with a long Mode S fruit. The calculation for the short Mode S format is similar, except that a window of 128 μ s is used to account for the length of the short reply.

The ATCRBS interference effect is estimated by calculating the probability of zero or one ATCRBS reply in an 84.3- μ s window. One reply is permitted in the listening window since Mode S has an error correction function that can correct for the effect of a single ATCRBS fruit. The individual probabilities are then multiplied to obtain the probability of successful squitter reception with the assumed fruit rate for each of the reply types. The details of the technique used for the estimation of short squitter reception probability are presented in Table 4.

4.2.5 Analysis Technique for Long Squitter Reception

The Poisson model is applied separately to each interfering reply type to calculate the probability of an interfering reply in the 120- μ s listening window needed to receive a long squitter.

For the long Mode S format, the probability of receiving zero replies in a 240- μ s window is calculated. The window of 240 μ s is used because a long squitter may not be correctly received if any part of the squitter is overlapped with a long Mode S fruit. The calculation for the short Mode S format is similar, except that a window of 184- μ s is used to account for the length of the short reply.

TABLE 3

ATCRBS Reception Analysis Model

- Poisson model used to calculate probability of successful reply
$$p[n] = (e^{-\lambda t}) * ((\lambda t)^n) / n!$$
- Success in Mode S interference is defined as probability of zero replies overlaying the desired squitter.
$$n = 0$$
$$\lambda = \text{total number of short Mode S fruit replies per second}$$
$$t = (64 + 20.3) * 10^{-6}$$

$$n = 0$$
$$\lambda = \text{total number of long Mode S fruit replies per second}$$
$$t = (120 + 20.3) * 10^{-6}$$
- Success in ATCRBS interference is defined as the probability of zero plus 0.50 times the probability one reply overlaying the desired ATCRBS reply. (ATCRBS replies have 0.45- μ s pulses on 1.35- μ s leading edges, so one overlapping ATCRBS reply may not prevent reception because the decoder can handle interleaved pulses).
$$n = 0 \text{ or } 1$$
$$\lambda = \text{total number of ATCRBS fruit replies per second}$$
$$t = (20.3 + 20.3) * 10^{-6}$$
- λ for each reply type is the product of the assumed reply rate per aircraft times the number of aircraft.
- Probabilities are calculated separately for ATCRBS, Mode S short, and Mode S long fruit replies.
- Overall reply probability (p) is the product of the individual probabilities.

TABLE 4

Short Squitter Reception Analysis Model

- Poisson model used to calculate probability of successful reply
$$p[n] = (e^{-\lambda t}) * ((\lambda t)^n) / n!$$
- Success in Mode S interference is defined as probability of zero replies overlaying the desired squitter.
$$n = 0$$
$$\lambda = \text{total number of short Mode S fruit replies per second}$$
$$t = (64 + 64) * 10^{-6}$$

$$n = 0$$
$$\lambda = \text{total number of long Mode S fruit replies per second}$$
$$t = (120 + 64) * 10^{-6}$$
- Success in ATCRBS interference is defined as the probability of zero or one reply overlaying the desired long squitter (error correction can handle one ATCRBS fruit reply).
$$n = 0 \text{ or } 1$$
$$\lambda = \text{total number of ATCRBS fruit replies per second}$$
$$t = (20.3 + 64) * 10^{-6}$$
- λ for each reply type is the product of the assumed reply rate per aircraft times the number of aircraft.
- Probabilities are calculated separately for ATCRBS, Mode S short and Mode S long fruit replies.
- Overall reply probability (p) is the product of the individual probabilities.

The ATCRBS interference effect is estimated by calculating the probability of zero or one ATCRBS reply in a 140.3- μ s window. One reply is permitted in the listening window since Mode S has an error correction function that can correct for the effect of a single ATCRBS fruit. The individual probabilities are then multiplied to obtain the probability of successful squitter reception with the assumed fruit rate for each of the reply types. Since two long squitters are transmitted per second, the probability of receiving at least one of the two squitters is calculated and used as the probability of a successful long squitter reception in one second. The details of the technique used for the estimation of long squitter reception probability are presented in Table 5.

4.3 INTERFERENCE MODEL

4.3.1 Airborne Aircraft

The interference model used to evaluate GPS-Squitter performance [3] is defined in terms of a rate of ATCRBS and Mode S replies per second per aircraft. Values chosen for the interference model are presented in Table 6, a breakdown of the Mode S reply source is presented in Table 7.

Case 1 is intended to represent a worst-case ATCRBS and Mode S environment. The 120 ATCRBS replies per second per transponder represent a higher rate than has been observed over extended areas in the United States, although higher rates have been observed in Europe. The Mode S rate of 14 replies per second per aircraft represents a very high level of Mode S and TCAS activity.

Case 2 represents an ATCRBS rate more typical of current high density environments in the United States.

Case 3 represents a future environment where ATCRBS activity has been replaced by Mode S.

4.3.2 Surface Aircraft

Currently, each Mode S transponder transmits one short squitter per second while on the airport surface. For the GPS-Squitter case, the total surface squitter rate is expected to be no more than 220 long squitters per second due to the variable squitter technique being used, as indicated in Section 3.3.1.

4.4 WORST-CASE TRAFFIC MODELS

4.4.1 Airborne Traffic

The design of TCAS was based upon a worst-case traffic model that included an aircraft density of 0.3 aircraft per square nautical mile out to a range of 5 nmi. This traffic density leads to a total of approximately 25 aircraft within a range of 5 nmi. Beyond 5 nmi the worst-case traffic model specified that the traffic growth was linear in range. In this extreme density, the maximum operating range of TCAS would be about 5 nmi. The surveillance performance for aircraft within 5 nmi can be affected by

replies received from 15 nmi, using the conservative assumption of a 10-dB fade margin. The linear in range traffic growth beyond 5 nmi yields a total traffic count of 75 aircraft within 15 nmi. The analysis will estimate performance of up to 100 aircraft within range of the modeled victim TCAS receiver.

TABLE 5

Long Squitter Reception Analysis Model

- Poisson model used to calculate probability of successful reply

$$p[n] = (e^{-\lambda t}) * ((\lambda t)^n) / n!$$
- Success in Mode S interference is defined as probability of zero replies overlaying the desired squitter.

$$n = 0$$

$$\lambda = \text{total number of short Mode S fruit replies per second}$$

$$t = (64 + 120) * 10^{-6}$$

$$n = 0$$

$$\lambda = \text{total number of long Mode S fruit replies per second}$$

$$t = (120 + 120) * 10^{-6}$$
- Success in ATCRBS interference is defined as the probability of zero or one reply overlaying the desired long squitter (error correction can handle one ATCRBS fruit reply).

$$n = 0 \text{ or } 1$$

$$\lambda = \text{total number of ATCRBS fruit replies per second}$$

$$t = (20.3 + 120) * 10^{-6}$$
- λ for each reply type is the product of the assumed reply rate per aircraft times the number of aircraft.
- Probabilities are calculated separately for ATCRBS, Mode S short and Mode S long fruit replies.
- Overall reply probability (p) is the product of the individual probabilities.
- Since there are 2 long squitters per second, the probability of at least 1 reply in 1 s is $1 - (1-p)^2$.

TABLE 6

Interference Cases

REPLIES PER SECOND PER AIRCRAFT			
CASE	ATCRBS	MODE S SHORT	MODE S LONG
1*	120	8	6
2	60	8	6
3**	0	8	6

* Current high density

** All Mode S with high data link activity

TABLE 7

Mode S Reply Source

SHORT REPLIES	
• GROUND SURVEILLANCE AND DATA LINK	1
• CURRENT SQUITTER	1
• ALL-CALL	1
• TCAS	5
LONG REPLIES	
• GPS-SQUITTER	2.2
• GROUND DATA LINK	3.8

4.4.2 Surface Traffic

Table 2 indicates a worst-case movement area traffic count of no more than 100 aircraft. To provide for growth, a surface traffic count of 150 aircraft will be used in the subsequent analysis.

4.5 DEFINITION OF FRUIT SCENARIOS

A summary of the airborne per aircraft reply rate and the total surface fruit rate for each of the three interference cases and levels of GPS-Squitter equipage is presented in Table 8. These rates define the environment for the TCAS interference analysis presented in this section. The values were selected as indicated next.

4.5.1 Airborne—ATCRBS Replies

GPS-Squitter operation does not affect the ATCRBS fruit environment. Therefore, the three cases defined in Table 6 were used for both the current and GPS-Squitter performance estimates.

4.5.2 Airborne—Short Mode S Transmissions

The short Mode S reply rate as indicated in Table 7 was used for the current performance estimates. For the 100% equipage case, aircraft will no longer be interrogated by TCAS and the reply rate will drop to 3 per second per aircraft. For the 50% equipage case, a reply rate 5.5 per second was used, which is midway between the 0% and 100% equipage cases.

4.5.3 Airborne—Long Mode S Transmissions

The long reply rate of 3.8 indicated in Table 7 was used for the current performance estimate. This rate was increased to 6 replies per second for the 100% equipage case, a midpoint of 4.9 replies per second was used for the 50% equipage case.

4.5.4 Surface—Short Mode S Squitters

Mode S aircraft currently transmit a short squitter once per second while on the airport surface. The 150 aircraft on the surface will generate 150 short squitters per second. This value was used for the current performance estimate. When half the aircraft are equipped for GPS-Squitter, this number will drop to 75 short squitters per second, since GPS-Squitter transponders do not transmit short squitters on the surface. The rate will drop to zero when all aircraft are equipped with GPS-Squitter.

TABLE 8
Fruit Scenarios
(Replies per Aircraft per second)

REPLY TYPE	FRUIT MODEL	
	CURRENT	GPS-SQUITTER
AIRBORNE ATCRBS PER AC CASE 1 CASE 2 CASE 3	120 60 0	120 60 0
AIRBORNE MODE S SHORT PER AC 0% 50% 100%	8	5.5 3
AIRBORNE MODE S LONG PER AC 0% 50% 100%	3.8	4.9 6
SURFACE SHORT MODE S TOTAL 0% 50% 100%	150	75 0
SURFACE LONG MODE S TOTAL 0% 50% 100%	0	110 220

4.5.5 Surface - Long Mode S Squitters

For the current environment, transponders do not transmit long squitters so a zero rate was used for the current performance. When 100% of the aircraft are equipped, it was assumed that they would generate no more than 220 long squitters per second, as indicated earlier. With 50% equipage, a rate of 110 was used.

4.6 TCAS INTERFERENCE ANALYSIS RESULTS

A comparison of TCAS reception probability for current and GPS-Squitter environments is presented in Tables 9 to 14. In each case, the fruit rates for the performance analysis of the current case are defined by the left column of Table 8. The fruit rates used for the GPS-Squitter case are defined in the right column.

The probabilities for the ATCRBS and short squitter cases are defined for a single reception. The probability for the long squitter is the probability of a squitter reception in a 1-s interval for which there are two long squitter opportunities.

4.7 TCAS RECEIVER SUMMARY

The reception probability difference column of Tables 7 to 12 shows the following range of relative performance for each format type:

ATCRBS:	2% reduction to 1% improvement
Short Squitter:	2% reduction to 2% improvement
Long Squitter:	Up to 12% improvement

This comparative reception performance indicates that GPS-Squitter activity will have a negligible negative effect on TCAS operation and in fact offers the possibility of a substantial improvement in surveillance reliability when TCAS uses ADS-based passive surveillance. Because of passive surveillance, the performance estimated for the GPS-Squitter case is also applicable to the case where all of the 100 aircraft in the traffic model are TCAS equipped.

TABLE 9

ATCRBS Reception with Airborne Fruit

50% EQUIPAGE

AIRCRAFT	ATCRBS RECEPTION PROBABILITY - AIRBORNE FRUIT								
	CURRENT			GPS-SQUITTER			PROBABILITY DIFFERENCE		
	CASE 1	CASE 2	CASE 3	CASE 1	CASE 2	CASE 3	CASE 1	CASE 2	CASE 3
1	0.9964	0.9976	0.9988	0.9964	0.9976	0.9988	0.01%	0.01%	0.01%
10	0.9639	0.9760	0.9880	0.9645	0.9765	0.9886	0.05%	0.06%	0.06%
25	0.9113	0.9407	0.9703	0.9126	0.9421	0.9716	0.13%	0.13%	0.14%
50	0.8278	0.8842	0.9414	0.8301	0.8867	0.9441	0.23%	0.25%	0.27%
75	0.7497	0.8304	0.9134	0.7529	0.8339	0.9173	0.32%	0.35%	0.39%
100	0.6771	0.7793	0.8863	0.6810	0.7837	0.8913	0.38%	0.44%	0.50%

100% EQUIPAGE

AIRCRAFT	ATCRBS RECEPTION PROBABILITY - AIRBORNE FRUIT								
	CURRENT			GPS-SQUITTER			PROBABILITY DIFFERENCE		
	CASE 1	CASE 2	CASE 3	CASE 1	CASE 2	CASE 3	CASE 1	CASE 2	CASE 3
1	0.9964	0.9976	0.9988	0.9965	0.9977	0.9989	0.01%	0.01%	0.01%
10	0.9639	0.9760	0.9880	0.9650	0.9771	0.9891	0.11%	0.11%	0.11%
25	0.9113	0.9407	0.9703	0.9139	0.9434	0.9730	0.26%	0.27%	0.27%
50	0.8278	0.8842	0.9414	0.8325	0.8892	0.9467	0.47%	0.50%	0.53%
75	0.7497	0.8304	0.9134	0.7560	0.8375	0.9212	0.64%	0.71%	0.78%
100	0.6771	0.7793	0.8863	0.6848	0.7881	0.8963	0.77%	0.88%	1.01%

TABLE 10

ATCRBS Reception with Airborne and Surface Fruit

50% EQUIPAGE

AIRCRAFT	ATCRBS RECEPTION PROBABILITY - AIRBORNE AND SURFACE FRUIT								
	CURRENT			GPS-SQUITTER			PROBABILITY DIFFERENCE		
	CASE 1	CASE 2	CASE 3	CASE 1	CASE 2	CASE 3	CASE 1	CASE 2	CASE 3
1	0.9838	0.9850	0.9862	0.9750	0.9762	0.9774	-0.89%	-0.89%	-0.89%
10	0.9518	0.9637	0.9756	0.9437	0.9555	0.9673	-0.81%	-0.82%	-0.83%
25	0.8999	0.9289	0.9581	0.8930	0.9218	0.9507	-0.69%	-0.71%	-0.73%
50	0.8174	0.8731	0.9296	0.8123	0.8676	0.9238	-0.51%	-0.55%	-0.58%
75	0.7403	0.8200	0.9019	0.7367	0.8160	0.8976	-0.36%	-0.40%	-0.44%
100	0.6686	0.7695	0.8751	0.6663	0.7668	0.8721	-0.23%	-0.27%	-0.30%

100% EQUIPAGE

AIRCRAFT	ATCRBS RECEPTION PROBABILITY - AIRBORNE AND SURFACE FRUIT								
	CURRENT			GPS-SQUITTER			PROBABILITY DIFFERENCE		
	CASE 1	CASE 2	CASE 3	CASE 1	CASE 2	CASE 3	CASE 1	CASE 2	CASE 3
1	0.9838	0.9850	0.9862	0.9662	0.9674	0.9685	-1.77%	-1.77%	-1.77%
10	0.9518	0.9637	0.9756	0.9357	0.9474	0.9591	-1.61%	-1.63%	-1.65%
25	0.8999	0.9289	0.9581	0.8861	0.9147	0.9434	-1.38%	-1.42%	-1.46%
50	0.8174	0.8731	0.9296	0.8072	0.8622	0.9180	-1.02%	-1.09%	-1.16%
75	0.7403	0.8200	0.9019	0.7331	0.8120	0.8932	-0.72%	-0.80%	-0.88%
100	0.6686	0.7695	0.8751	0.6640	0.7642	0.8691	-0.46%	-0.53%	-0.60%

TABLE 11

Short Squitter Reception with Airborne Fruit

50% EQUIPAGE

TCAS SHORT SQUITTER RECEPTION PROBABILITY - AIRBORNE FRUIT									
AIRCRAFT	CURRENT			GPS-SQUITTER			PROBABILITY DIFFERENCE		
	CASE 1	CASE 2	CASE 3	CASE 1	CASE 2	CASE 3	CASE 1	CASE 2	CASE 3
1	0.9982	0.9983	0.9983	0.9983	0.9984	0.9984	0.01%	0.01%	0.01%
10	0.9783	0.9817	0.9829	0.9794	0.9829	0.9841	0.12%	0.12%	0.12%
25	0.9321	0.9509	0.9578	0.9349	0.9537	0.9607	0.27%	0.28%	0.28%
50	0.8336	0.8928	0.9175	0.8385	0.8981	0.9229	0.49%	0.53%	0.54%
75	0.7246	0.8298	0.8788	0.7310	0.8372	0.8866	0.64%	0.74%	0.78%
100	0.6169	0.7648	0.8417	0.6242	0.7739	0.8517	0.73%	0.90%	1.00%

100% EQUIPAGE

TCAS SHORT SQUITTER RECEPTION PROBABILITY - AIRBORNE FRUIT									
AIRCRAFT	CURRENT			GPS-SQUITTER			PROBABILITY DIFFERENCE		
	CASE 1	CASE 2	CASE 3	CASE 1	CASE 2	CASE 3	CASE 1	CASE 2	CASE 3
1	0.9982	0.9983	0.9983	0.9985	0.9985	0.9985	0.02%	0.02%	0.02%
10	0.9783	0.9817	0.9829	0.9806	0.9840	0.9852	0.23%	0.23%	0.23%
25	0.9321	0.9509	0.9578	0.9376	0.9565	0.9635	0.55%	0.56%	0.56%
50	0.8336	0.8928	0.9175	0.8435	0.9034	0.9283	0.99%	1.06%	1.09%
75	0.7246	0.8298	0.8788	0.7375	0.8446	0.8944	1.29%	1.48%	1.56%
100	0.6169	0.7648	0.8417	0.6316	0.7830	0.8618	1.47%	1.82%	2.00%

TABLE 12

Short Squitter Reception with Airborne and Surface Fruit

50% EQUIPAGE

TCAS SHORT SQ RECEPTION PROBABILITY - AIRBORNE AND SURF FRUIT									
AIRCRAFT	CURRENT			GPS-SQUITTER			PROBABILITY DIFFERENCE		
	CASE 1	CASE 2	CASE 3	CASE 1	CASE 2	CASE 3	CASE 1	CASE 2	CASE 3
1	0.9792	0.9793	0.9793	0.9690	0.9690	0.9690	-1.02%	-1.02%	-1.02%
10	0.9597	0.9630	0.9642	0.9506	0.9540	0.9551	-0.90%	-0.91%	-0.91%
25	0.9144	0.9328	0.9396	0.9074	0.9256	0.9324	-0.70%	-0.72%	-0.72%
50	0.8178	0.8758	0.9000	0.8139	0.8717	0.8957	-0.39%	-0.42%	-0.43%
75	0.7108	0.8140	0.8621	0.7095	0.8126	0.8605	-0.13%	-0.15%	-0.16%
100	0.6052	0.7503	0.8257	0.6058	0.7511	0.8266	0.07%	0.08%	0.09%

100% EQUIPAGE

TCAS SHORT SQ RECEPTION PROBABILITY - AIRBORNE AND SURF FRUIT									
AIRCRAFT	CURRENT			GPS-SQUITTER			PROBABILITY DIFFERENCE		
	CASE 1	CASE 2	CASE 3	CASE 1	CASE 2	CASE 3	CASE 1	CASE 2	CASE 3
1	0.9792	0.9793	0.9793	0.9589	0.9589	0.9589	-2.04%	-2.04%	-2.04%
10	0.9597	0.9630	0.9642	0.9417	0.9450	0.9461	-1.80%	-1.81%	-1.81%
25	0.9144	0.9328	0.9396	0.9004	0.9185	0.9253	-1.40%	-1.43%	-1.44%
50	0.8178	0.8758	0.9000	0.8100	0.8675	0.8915	-0.77%	-0.83%	-0.85%
75	0.7108	0.8140	0.8621	0.7083	0.8111	0.8589	-0.26%	-0.30%	-0.31%
100	0.6052	0.7503	0.8257	0.6065	0.7520	0.8276	0.14%	0.17%	0.19%

TABLE 13

ADS Squitter Reception (per second) with Airborne Fruit

50% EQUIPAGE

TCAS SQUITTER RECEPTION PROB (1 SEC) - AIRBORNE FRUIT									
AIRCRAFT	CURRENT SHORT SQUITTER			GPS-SQUITTER			PROBABILITY DIFFERENCE		
	CASE 1	CASE 2	CASE 3	CASE 1	CASE 2	CASE 3	CASE 1	CASE 2	CASE 3
1	0.9982	0.9983	0.9983	1.0000	1.0000	1.0000	0.18%	0.17%	0.17%
10	0.9783	0.9817	0.9829	0.9988	0.9994	0.9995	2.06%	1.77%	1.66%
25	0.9321	0.9509	0.9578	0.9864	0.9949	0.9972	5.43%	4.40%	3.93%
50	0.8336	0.8928	0.9175	0.9171	0.9732	0.9893	8.35%	8.04%	7.18%
75	0.7246	0.8298	0.8788	0.7922	0.9307	0.9771	6.76%	10.09%	9.83%
100	0.6169	0.7648	0.8417	0.6417	0.8692	0.9614	2.48%	10.44%	11.97%

100% EQUIPAGE

TCAS SQUITTER RECEPTION PROB (1 SEC) - AIRBORNE FRUIT									
AIRCRAFT	CURRENT SHORT SQUITTER			GPS-SQUITTER			PROBABILITY DIFFERENCE		
	CASE 1	CASE 2	CASE 3	CASE 1	CASE 2	CASE 3	CASE 1	CASE 2	CASE 3
1	0.9982	0.9983	0.9983	1.0000	1.0000	1.0000	0.18%	0.17%	0.17%
10	0.9783	0.9817	0.9829	0.9990	0.9995	0.9996	2.07%	1.78%	1.67%
25	0.9321	0.9509	0.9578	0.9874	0.9955	0.9976	5.53%	4.47%	3.98%
50	0.8336	0.8928	0.9175	0.9211	0.9759	0.9910	8.75%	8.30%	7.36%
75	0.7246	0.8298	0.8788	0.7995	0.9364	0.9807	7.48%	10.65%	10.20%
100	0.6169	0.7648	0.8417	0.6511	0.8782	0.9674	3.42%	11.33%	12.57%

TABLE 14

ADS Squitter Reception (per second) with Airborne and Surface Fruit

50% EQUIPAGE

TCAS SQUITTER RECEPTION PROB (1 SEC) - AIRBORNE AND SURF FRUIT									
AIRCRAFT	CURRENT SHORT SQUITTER			GPS-SQUITTER			PROBABILITY DIFFERENCE		
	CASE 1	CASE 2	CASE 3	CASE 1	CASE 2	CASE 3	CASE 1	CASE 2	CASE 3
1	0.9792	0.9793	0.9793	0.9983	0.9983	0.9983	1.90%	1.90%	1.90%
10	0.9597	0.9630	0.9642	0.9948	0.9960	0.9964	3.52%	3.29%	3.22%
25	0.9144	0.9328	0.9396	0.9771	0.9883	0.9918	6.27%	5.56%	5.22%
50	0.8178	0.8758	0.9000	0.9002	0.9614	0.9807	8.24%	8.55%	8.07%
75	0.7108	0.8140	0.8621	0.7722	0.9146	0.9659	6.13%	10.06%	10.38%
100	0.6052	0.7503	0.8257	0.6225	0.8504	0.9479	1.73%	10.01%	12.22%

100% EQUIPAGE

TCAS SQUITTER RECEPTION PROB (1 SEC) - AIRBORNE AND SURF FRUIT									
AIRCRAFT	CURRENT SHORT SQUITTER			GPS-SQUITTER			PROBABILITY DIFFERENCE		
	CASE 1	CASE 2	CASE 3	CASE 1	CASE 2	CASE 3	CASE 1	CASE 2	CASE 3
1	0.9792	0.9793	0.9793	0.9971	0.9972	0.9972	1.79%	1.79%	1.79%
10	0.9597	0.9630	0.9642	0.9933	0.9946	0.9951	3.36%	3.16%	3.09%
25	0.9144	0.9328	0.9396	0.9751	0.9868	0.9905	6.07%	5.40%	5.09%
50	0.8178	0.8758	0.9000	0.8990	0.9605	0.9800	8.12%	8.46%	8.00%
75	0.7108	0.8140	0.8621	0.7732	0.9155	0.9665	6.24%	10.14%	10.44%
100	0.6052	0.7503	0.8257	0.6258	0.8537	0.9504	2.07%	10.34%	12.47%

5. SUMMARY AND CONCLUSIONS

5.1 SUMMARY

An analysis of GPS-Squitter effects on current users of the beacon frequencies has been performed by determining the effect of GPS-Squitter related transmissions on transponder, Mode S sensor, and TCAS receivers. The transponder and Mode S sensor analysis was performed by estimating the channel occupancy required by these transmissions. The TCAS analysis was performed by comparing TCAS reception probability for ATRCBS replies and Mode S squitters for various levels of GPS-Squitter equipage.

5.1.1 Transponder Receiver

A worst-case 1030-MHz analysis indicated that the occupancy caused by the use of the associated Mode S data link (for broadcast and two-way data link service) would be less than 0.6% in a terminal area, and less than 1.6% in an en route area where GPS-Squitter stations were providing the maximum two-way data link service.

5.1.2 Mode S Sensor Receiver

A worst-case 1090-MHz analysis indicated that the total channel occupancy would be 0.65% for an en route sensor. For a terminal sensor, the worst-case occupancy would be 0.77%, plus a maximum worst-case probability of missing a desired surveillance scan update of 0.2% due to surface squitter operation.

5.1.3 TCAS Receiver

A comparison was made of the probability of receiving a desired ATRCBS or Mode S 1090-MHz transmission in worst-case fruit environments with and without GPS-Squitter activity. The comparison indicated that reception performance for ATRCBS, short squitter and long squitter reception ranged from a 2% reduction up to a 12% improvement as GPS-Squitter equipage was increased.

5.2 CONCLUSIONS

Based on the preceding analysis, the following conclusions can be drawn:

- GPS-Squitter will have a negligible negative effect on a transponder, Mode S sensor, or TCAS receiver.
- Beacon system performance improves with high levels of GPS-Squitter equipage since TCAS channel occupancy is reduced.
- GPS-Squitter will not interfere with current activities on 1030/1090 MHz.

REFERENCES

1. V.A. Orlando, "ADS-Mode S: Initial System Description," Project Rep. ATC-200, Lexington, Mass.: MIT Lincoln Laboratory (2 April 1993).
2. V.A. Orlando and P.R. Drouilhet, "Mode S Beacon System: Functional Description," Project Rep. ATC-42, Rev. D, Lexington, Mass.: MIT Lincoln Laboratory (29 August 1986).
3. V.A. Orlando and W.H. Harman, "GPS-Squitter Capacity Analysis," Project Rep. ATC-214, Lexington, Mass.: MIT Lincoln Laboratory (20 May 1994).
4. RTCA Task Force 2 Report, "The Transition to Digital Communications: Urgent Needs, Practical Means" (December 1993) with Appendices.
5. V.A. Orlando and G.H. Knittel, "GPS-Squitter: System Concept and Performance," Air Traffic Control Quarterly, Vol.(4), 303-326 (1994).
6. "Mode S Sensor Specification," FAA-E-2716 (24 March 1983) with Amendments.