

**Project Report
ATC-104**

Radar Beacon Transponder (RBX) Functional Description

R.G. Sandholm

18 February 1981

Lincoln Laboratory
MASSACHUSETTS INSTITUTE OF TECHNOLOGY
LEXINGTON, MASSACHUSETTS

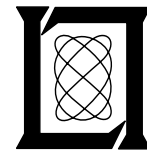

Prepared for the Federal Aviation Administration,
Washington, D.C. 20591

This document is available to the public through
the National Technical Information Service,
Springfield, VA 22161

This document is disseminated under the sponsorship of the Department of Transportation in the interest of information exchange. The United States Government assumes no liability for its contents or use thereof.

1. Report No. FAA-RD-80-135		2. Government Accession No.		3. Recipient's Catalog No.	
4. Title and Subtitle Radar Beacon Transponder (RBX) Functional Description...				5. Report Date ...18 February 1981	
				6. Performing Organization Code	
7. Author(s) Ronald G. Sandholm				8. Performing Organization Report No. ATC-104	
9. Performing Organization Name and Address Massachusetts Institute of Technology ... Lincoln Laboratory ... P.O. Box 73 ... Lexington, MA 02173				10. Work Unit No. (TRAIS)	
				11. Contract or Grant No. ... DOT-FA77-WAI-817	
12. Sponsoring Agency Name and Address Department of Transportation ... Federal Aviation Administration ... Systems Research and Development Service ... Washington, DC 20591				13. Type of Report and Period Covered Project Report	
				14. Sponsoring Agency Code	
15. Supplementary Notes The work reported in this document was performed at Lincoln Laboratory, a center for research operated by Massachusetts Institute of Technology under Air Force Contract F19628-80-C-0002.					
16. Abstract The Radar Beacon Transponder (RBX) is a ground-based transponder used to control the threat-detection sensitivity level of BCAS aircraft operating in high density terminal airspace. The RBX is also used to deliver displayed resolution advisories from BCAS to the ATC facility. The normal DABS interrogation waveforms and message formats are used for communication between the RBX and BCAS aircraft. The appropriate BCAS sensitivity level is selected by comparing the BCAS aircraft position with an internally stored sensitivity level map of the surrounding airspace volume. This document provides a functional description of the RBX and shows that reliable performance is achievable in the presence of interference from ATCRBS and BCAS air-to-air interrogations.					
17. Key Words RBX BCAS DABS ATCRBS ATC Sensitivity level			18. Distribution Statement Document is available to the public through the National Technical Information Service, Springfield, Virginia 22161		
19. Security Classif. (of this report) Unclassified		20. Security Classif. (of this page) Unclassified		21. No. of Pages 30	22. Price

CONTENTS

	<u>Page</u>
1.0 OVERVIEW AND SUMMARY	1
1.1 Introduction	1
1.2 RBX Concept	1
1.3 Interaction of RBX with BCAS and ATC	2
2.0 THE RBX DATA LINK	6
2.1 Signal Waveforms	6
2.2 Signal Content	6
2.3 Message Formats	7
3.0 RBX GROUND EQUIPMENT	10
3.1 Transmission Control	10
3.2 System Clock	10
3.3 Modulator/Transmitter	12
3.4 Antenna System	12
3.5 Receiver	12
3.6 Interrogation Signal Processing	14
3.7 RBX Processor	14
3.7.1 Sensitivity Level Selection	14
3.7.2 ATC Communication Data Link Interface	16
3.7.3 ATC Remote Control Interface	17
3.8 Performance Monitoring	17
4.0 RBX PERFORMANCE	18
4.1 Link Reliability	18
4.1.1 Link Power Budget	18
4.1.2 RBX Antenna Lobing	18
4.1.3 Aircraft Antenna Fading	18
4.1.4 Interference Effects	22
4.1.5 Net Link Reliability	25
REFERENCES	26

ILLUSTRATIONS

<u>Figure</u>		<u>Page</u>
1	Relationship of RBX to Elements of BCAS and ARTS	3
2	Sequence of Events and Information Transfer between RBX and BCAS	4
3	RBX Link Formats	8
4	RBX Functional Block Diagram	11
5	Example of an RBX Front End	13
6	Side View of RBX Coverage Volume	15
7	Vertical Lobing	20
8	Aircraft Antenna Summary Statistics	21
9	Probability of RBX 3-pulse Detection of a Single BCAS Interrogation in the Presence of Noise Alone and Noise Plus Interference.	24

TABLES

<u>Table</u>		<u>Page</u>
1	RBX/BCAS Link Power Budget	19

1.0 OVERVIEW AND SUMMARY

1.1 Introduction

A previous study (Ref. 1) indicates that an Active BCAS-equipped aircraft operating with its normal detection parameters in terminal airspace experiences a certain number of unnecessary alarms.

The number of unwanted alarms can be reduced by desensitizing the parameters associated with the BCAS threat logic. That is, the threat logic parameter values or the BCAS "sensitivity level" can be adjusted to correspond to the traffic environment in which the BCAS equipped aircraft is operating.

Control of the BCAS sensitivity level is accomplished automatically by one or more ground stations located in the terminal area. Each ground station maintains an internally stored sensitivity level map of the airspace volume surrounding its location. The map is made up of a number of pre-defined boundary regions, each of which is assigned an applicable BCAS sensitivity level based on the expected traffic density within that region. Knowledge of the position of the BCAS-equipped aircraft within this map will enable the ground station to select and communicate the proper sensitivity level command.

In terminal areas containing a DABS sensor, the BCAS position measurement and sensitivity level control are accomplished via the normal DABS sensor surveillance and data link functions. In non-DABS terminal areas or in DABS-equipped terminal areas requiring additional outlying ground stations for sensitivity level control, the control of BCAS sensitivity level is accomplished by ground-based Radar Beacon Transponders (RBX's).

In addition to controlling the BCAS sensitivity level, the RBX supports terminal area coordination by delivering resolution advisories generated by BCAS (and displayed to the pilot) to the ATC facility.

1.2 RBX Concept

Conceptually the RBX is much like a DABS transponder located on the ground. A BCAS-equipped aircraft acquires and tracks the RBX in a manner similar to the way it would acquire and track an airborne DABS transponder. In addition to its transponder functions, the RBX maintains a stored coverage map partitioned in up to five pre-determined regions. Each region is assigned a BCAS threat logic sensitivity level which, when used by BCAS, will control the number of unnecessary alarms. The range and altitude boundaries, and the sensitivity level associated with each of the five spatial regions, can be adjusted either locally or by a remote air traffic control (ATC) facility.

An RBX being tracked by a BCAS equipped aircraft receives downlinked range and altitude reports as well as displayed resolution advisory information. Based on the position of a BCAS-equipped aircraft, the RBX automatically selects the applicable sensitivity level from its stored map of region boundaries and transmits the appropriate message to the aircraft. The RBX is required to provide sensitivity level control to all BCAS-equipped aircraft operating within a predetermined range of the RBX. This range is defined for each RBX by a range threshold value which is variable up to a maximum of 50 nmi.

In addition to the desensitization task, the RBX is required to deliver displayed resolution advisories from BCAS-equipped aircraft to ATC for display to the appropriate controller. BCAS-equipped aircraft are required to provide this information in the downlink signal when operating within the threshold range of the RBX.

1.3 Interaction of RBX with BCAS and ATC

Figure 1 shows the relationship of the ground RBX equipment to BCAS-equipped aircraft, the terminal ATC facility and the ATCRBS sensor. The primary function of the RBX is to control the BCAS sensitivity level to correspond to the location of BCAS in the terminal airspace and to relay displayed resolution advisories from BCAS to the ATC facility.

Figure 2 illustrates the sequence of events and information transfer that occurs between the RBX and a BCAS aircraft. The RBX transmits squitters every 4 seconds to indicate its presence and announce its address to the BCAS aircraft. The squitter transmissions elicit no reply from the airborne equipment. When a BCAS-equipped aircraft first receives a squitter transmission it initiates track acquisition by discretely interrogating the RBX. If no reply is received in response to the first interrogation the acquisition attempt is repeated. If the second attempt is also unsuccessful, further attempts are not made until receipt of the next squitter.

The first successful reply from the RBX enables the BCAS aircraft to compute its range to the RBX. Each RBX is assigned a threshold range beyond which it is not required to provide BCAS sensitivity control and BCAS-equipped aircraft are not required to deliver displayed resolution advisories. This range threshold value is encoded in each RBX reply. If the measured range and the BCAS maximum speed capability indicate that the BCAS aircraft has already penetrated or could soon penetrate the RBX range threshold, BCAS establishes track and continues to update the track by discretely interrogating the RBX at 4-second intervals. Failure to receive a reply to a tracking interrogation is followed by four consecutive interrogations, if necessary, before coast is established for that 4-second period. Four such coast periods are maintained before track is dropped. If the BCAS aircraft could not soon penetrate the RBX range threshold value, BCAS suspends further interrogations to the RBX. Subsequent squitters from the RBX are ignored and further acquisition attempts are delayed until the earliest time that BCAS predicts it could reach the RBX range threshold.

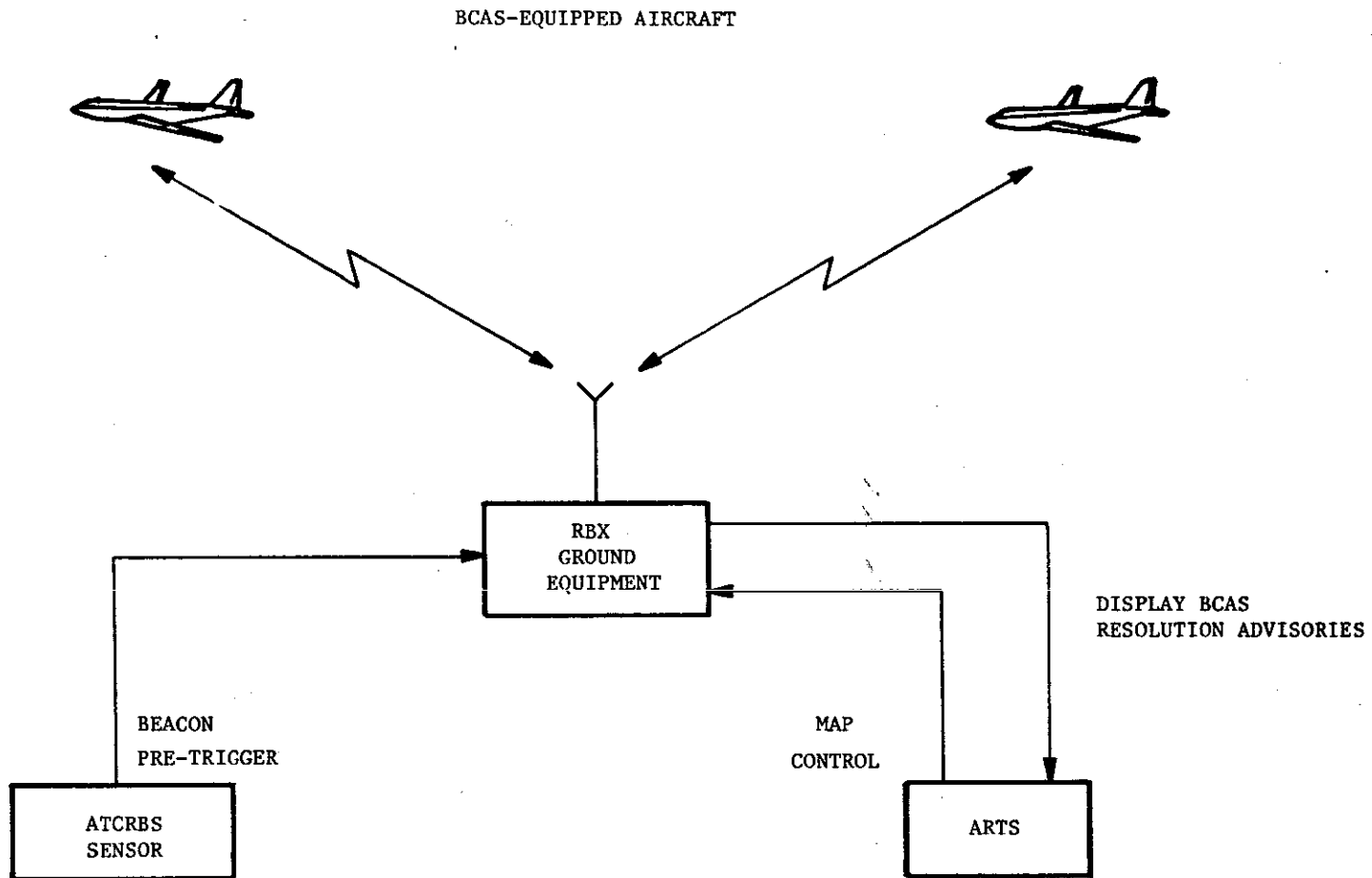

Fig. 1. Relationship of RBX to elements of BCAS and ARTS.

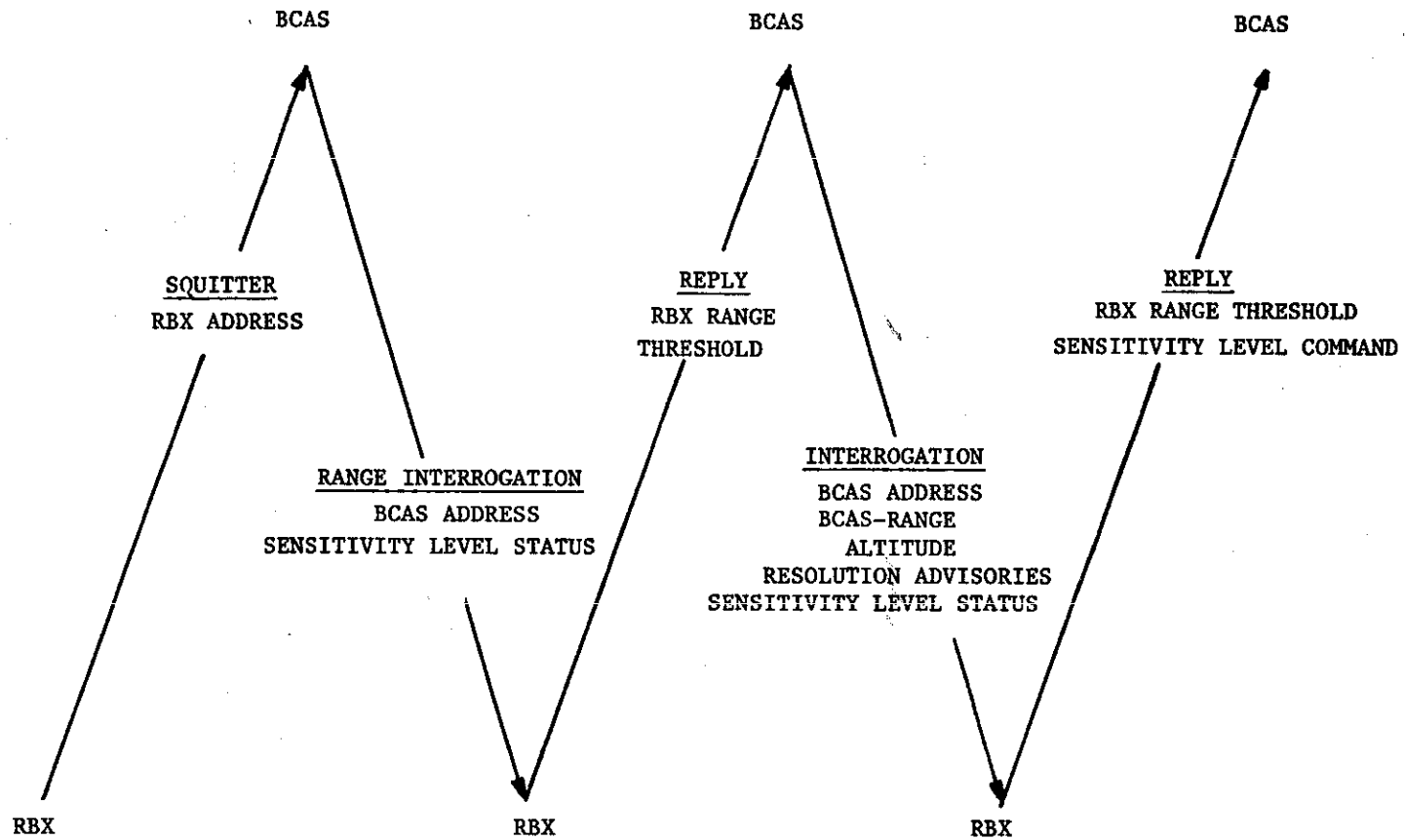

Fig. 2. Sequence of events and information transfer between RBX and BCAS.

All interrogations to the RBX contain range data computed from the previous interrogation and reply transaction. They also include the current BCAS altitude, all displayed resolution advisories, and an indication of the last sensitivity level command received from this RBX. The latter information is used by RBX to prevent oscillations in sensitivity level commands for BCAS aircraft flying close to region boundaries. Based on the range, altitude and sensitivity level status reports in each interrogation, the RBX selects the appropriate sensitivity level from its stored map and includes the associated command in the reply to the BCAS aircraft. Throughout the coverage region BCAS continues to track the RBX, and the RBX continues to monitor the BCAS range and altitude and to readjust the BCAS sensitivity level accordingly.

An interface between the local ATCRBS sensor and the RBX is provided to eliminate RBX interference to the ATCRBS sensor operation. The interface functions to inhibit RBX transmissions during the time of ATCRBS sensor interrogation.

A communication data link between the RBX and an automated ARTS III A or ARTS II facility enables RBX to deliver displayed resolution advisories for ATC display. The data link will also enable the ARTS facility to change the RBX coverage map to match different terminal area traffic density distributions and flight patterns. In non-automated terminal areas a remote control device is provided to allow ATC personnel a limited selection of prestored RBX coverage maps.

2.0 THE RBX DATA LINK

2.1 Signal Waveforms

The data link between the RBX and a BCAS-equipped aircraft uses three types of signals to accomplish the task of RBX acquisition and tracking, BCAS sensitivity level control and coordination of BCAS resolution advisories with ATC. The RF characteristics of the signal waveforms are identical to the DABS interrogation waveforms as defined in the DABS National Standard (Ref. 2) with the exception of the SLS P5 pulse, which is not used. The RBX/BCAS link signals are as follows:

- (a) RBX Squitter. This is a 1030 MHz DABS discrete interrogation waveform with a short (56-bit) data field. The squitter is transmitted with a broadcast address at a nominal period of 4 seconds by an RBX to indicate its presence to BCAS-equipped aircraft. BCAS acquisition of the RBX is initiated on receipt of a squitter signal.
- (b) BCAS Interrogation. This is a 1030 MHz DABS discrete interrogation waveform with a long (112-bit) data field. It is used by BCAS for RBX acquisition, surveillance and data link communication of BCAS position, as well as resolution advisories and sensitivity level information. Following acquisition, BCAS discrete interrogations are transmitted every 4 seconds to maintain RBX track within its coverage volume.
- (c) RBX Reply. This is a 1030 MHz DABS discrete interrogation waveform with a short (56-bit) data field. RBX discrete replies are generated in response to BCAS interrogations for communication of BCAS sensitivity level commands.

All of the waveforms between the RBX and a BCAS-equipped aircraft are transmitted at 1030 MHz as opposed to 1090 MHz in order to take advantage of the lower interference environment and therefore maximize the effective range of the RBX. A more complete analysis of the effect of interference on RBX link reliability is contained in Chapter 4.

2.2 Signal Content

The arrangement of the data block information within the RBX and BCAS transmissions is based on the format structure specified in the Active BCAS National Standard (Ref. 3). All transmissions contain two essential fields consisting of a standardized 5-bit format descriptor (UF) at the beginning of the data block which identifies the purpose of the transmission and a 24-bit parity encoded address field (AP) at the end of the data block. All RBX/BCAS link waveforms are assigned a format descriptor of either UF=6 for 56-bit transmissions or UF=22 for 112-bit transmissions. The address/parity (AP)

field for the RBX/BCAS link transmissions always contains either the recipient address (i.e., the RBX address for BCAS interrogations or BCAS address for RBX replies) or, in the case of RBX squitters, an all 1's broadcast address. The remaining space within the data block is used to transmit the data link information which is arranged in dedicated mission fields and subfields. The organization of the RBX/BCAS data block format in this manner is compatible with any future system evolution. Short messages can be expanded into long messages, mission field data can be rearranged and squitter transmissions can be delivered in multi-segment bursts without impacting on the design of the BCAS DABS transponder.

The 24-bit address/parity (AP) field contains the recipient's unique address (or broadcast address) code overlaid on 24 parity check bits generated by the preceding part of the transmission. An error occurring anywhere in the reception of an interrogation, reply or squitter will modify the decoded address and cause the reception to be rejected. Generation of the address/parity field is described in paragraph 4.1.2 of the DABS National Standard.

2.3 Message Formats

The arrangement and description of the information within each of the RBX/BCAS transmissions is presented in detail in the Active BCAS National Standard (Ref. 3) and summarized here. The decimal equivalent of the binary code formed by the bit sequence within a field is used as the field designator in the following description.

(a) RBX Squitter (format illustrated in Figure 3a)

UF - A 5-bit uplink format field which identifies the message as a 56-bit RBX transmission and inhibits the aircraft DABS transponder from replying. UF=6 for an RBX squitter or reply transmission.

RD - A 3-bit subfield which identifies the transmission as either a squitter (RD=1) a reply (RD=2) or defines the contents of the succeeding MR mission field as not present (RD=0). The remaining RD values are currently unassigned.

RAD - A 24-bit subfield containing the discrete address code of the RBX.

AP - A 24-bit address/parity field containing an all 1's broadcast address overlaid on 24 parity check bits. This address enables the BCAS DABS transponder to accept the squitter.

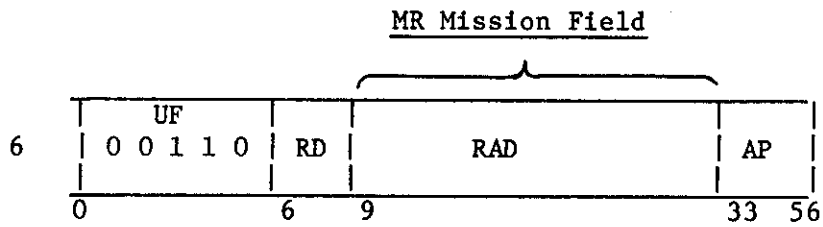

(a) RBX Squitter Format

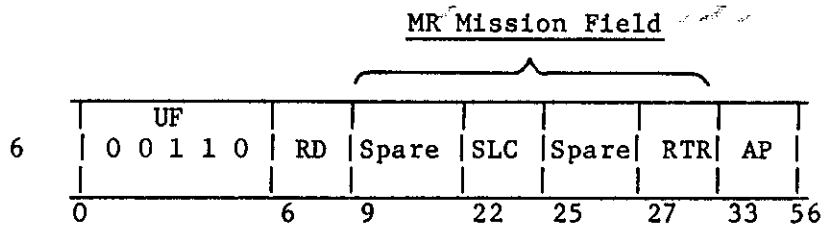

(b) RBX Reply Format

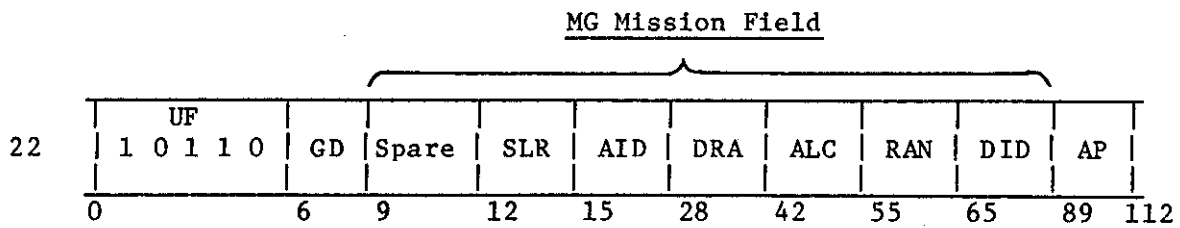

(c) BCAS Interrogation Format

Fig. 3. RBX link formats.

(b) RBX Reply (format illustrated in Figure 3b)

UF - Same as above.

RD - Same as above.

SLC - A 3-bit subfield containing the sensitivity level command from RBX to BCAS. A zero value is used in the initial reply to a ranging interrogation to indicate no data available and therefore no command issued. In subsequent replies command values of 1 to 7 refer respectively to BCAS sensitivity levels 1 to 7.

RTR - A 6-bit subfield to indicate to BCAS the range threshold value within which RBX is required to operate and BCAS is required to maintain RBX track. The value is expressed in round trip time with an LSB of 16 μ sec (\approx 1.3 nmi).

AP - A 24-bit field containing the discrete address of the BCAS/DABS transponder overlaid on 24 parity check bits.

(c) BCAS Interrogation (format illustrated in Figure 3c)

UF - A 5-bit uplink format field which identifies the message as a 112 bit BCAS transmission. UF=22 for a BCAS interrogation to RBX.

GD - A 3-bit field which defines the contents of the succeeding MG mission field as either not present (GD=0) or containing active BCAS interrogation information (GD=1). Remaining GD values are currently unassigned.

SLR - A 3-bit subfield containing the last sensitivity level command received from the RBX to which this interrogation is addressed.

AID - A 13-bit subfield containing the ATCRBS mode A code (4096 code) of the BCAS aircraft.

DRA - A 14-bit subfield containing the resolution advisory currently displayed to the pilot.

ALC - A 13-bit subfield containing the altitude code of the BCAS aircraft.

RAN - A 10-bit subfield containing the BCAS to RBX range estimate. The value is expressed in round trip travel time with an LSB of 2 μ sec (\approx 0.16 nmi). RAN in the initial or ranging interrogation is set to all 1's to indicate no data available. This causes the RBX reply SLC subfield to be set to zero.

DID - A 24-bit subfield containing the discrete address of the BCAS aircraft DABS transponder.

AP - A 24-bit field containing the discrete address of RBX overlaid on 24 parity check bits.

3.0 RBX GROUND EQUIPMENT

The RBX ground equipment generates periodic squitter signals in order to allow passive acquisition by BCAS-equipped aircraft. Following acquisition, the RBX ground equipment responds to each of the periodic BCAS interrogations with a reply delayed by a fixed amount. The transactions between the RBX and BCAS enable the RBX to select and communicate to BCAS a sensitivity level command and to receive from BCAS displayed resolution advisories which are sent to the ATC facility via a two-way ground communication link. This same communication link also enables ATC to modify the RBX map parameters and sensitivity level commands issued to BCAS-equipped aircraft. An interface to the ATCRBS sensor provides the RBX with beacon pre-triggers for use in controlling RBX-to-ATCRBS interference.

The major functions of the RBX ground equipment are illustrated in the block diagram of Figure 4.

3.1 Transmission Control

Transmission control prepares the message content and determines the time of RBX squitter and reply transmissions. A digital control signal containing the transmit time and the appropriate data field information is sent to the modulator/transmitter prior to each squitter or reply transmission. RBX transmissions are further controlled by beacon pre-trigger signals to insure that they do not pre-suppress ATCRBS transponders and interfere with the normal surveillance function of the local ATCRBS site. On receipt of a beacon pre-trigger signal, transmission control will establish a 75- μ sec guard interval immediately preceding the zero range time of the ATCRBS sensor. RBX transmissions are prohibited during this interval of time.

To prevent the possibility of synchronous interference to other ATCRBS sensors, RBX squitters are randomly jittered about their nominal transmission rate. Squitter commands are generated by transmission control at random intervals that are uniformly distributed over the range from 3.8 to 4.2 seconds except that any squitter transmission scheduled in the 75- μ sec guard interval will be delayed until after completion of the guard interval.

In order to provide sufficient time to process BCAS interrogations and to prepare the message content of RBX replies, the transmission time of the reply synch phase reversal is designed to occur 500 μ sec after receipt of the interrogation synch phase reversal. The 500- μ sec turn-around time is standard for all RBX ground equipments and factored into the range estimate by the BCAS-equipped aircraft. Any RBX reply scheduled in the 75- μ sec interval preceding the zero range time of the ATCRBS sensor will be aborted by transmission control.

3.2 System Clock

The RBX employs a system clock to establish the nominal squitter transmission rate and to control the actual transmission time of the squitter and reply. The system clock also provides the timing reference for detection and decoding of the BCAS interrogations.

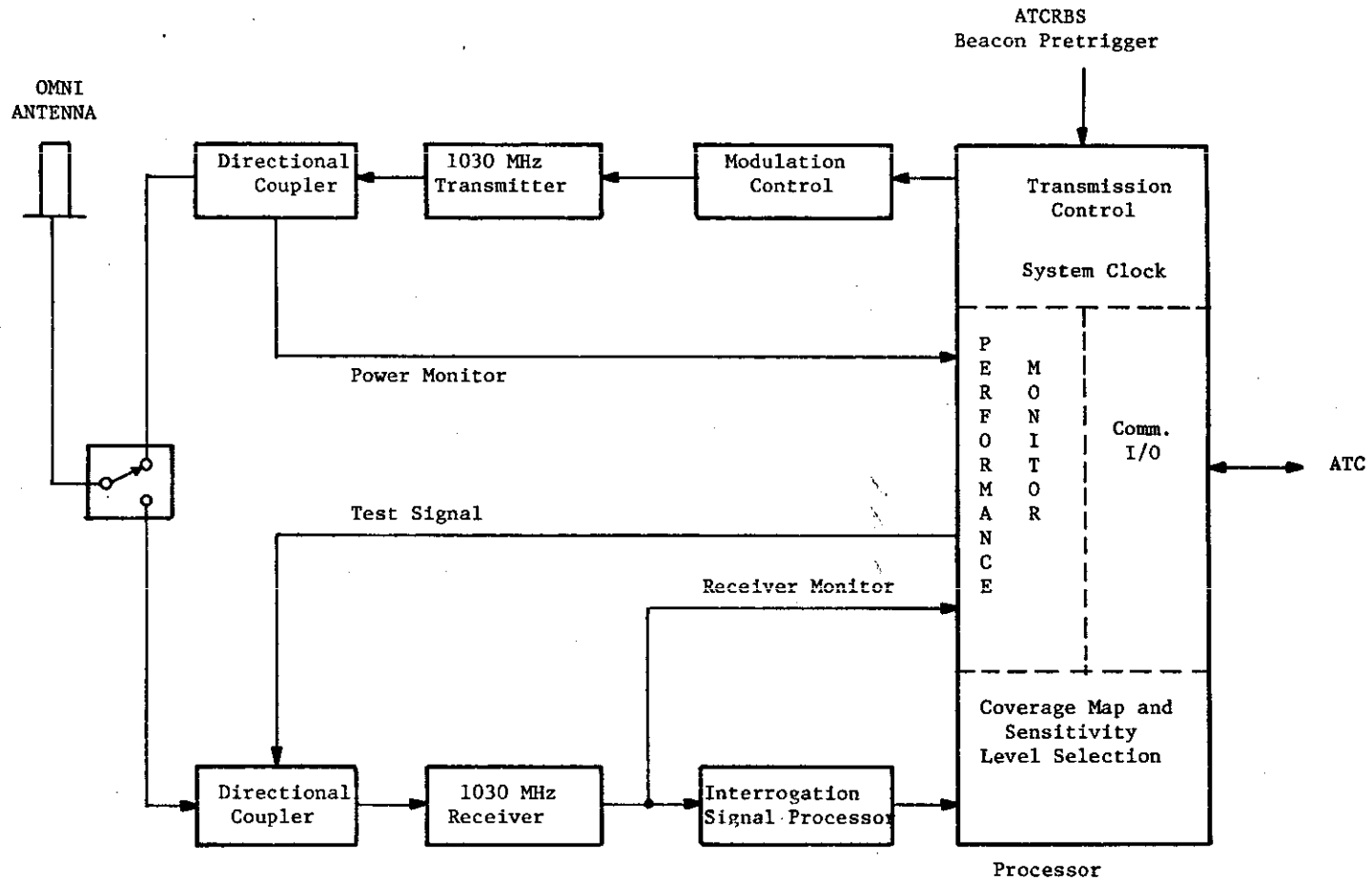

11

Fig. 4. RBX functional block diagram.

3.3 Modulator/Transmitter

The modulator accepts digital control signals from transmission control and generates the squitter and reply transmitter modulation signals. The squitter and reply control inputs from transmission control specify the waveform type, the transmission time and the contents of the data field. The modulator generates a sequence of parity check bits by operating on the information field and combines these bits with the all 1's broadcast address in the case of a squitter and the BCAS discrete address in the case of a reply. The PAM modulated preamble and the DPSK modulated P6 data field for each squitter and reply is sent to the transmitter at the appropriate time as determined by comparison of the transmission time with the system clock.

Squitters and replies are transmitted at a peak power of 2 KW as measured at the antenna terminal.

3.4 Antenna System

The RBX, because of its functional similarity to a ground based transponder system, requires an omni-directional antenna for transmission of squitters and replies and reception of BCAS interrogations. The elevation pattern characteristics of the omni antenna should be chosen to provide sufficient cutoff at the horizon and as much low angle gain as possible for long-range aircraft. The design should balance these basic requirements with satisfactory high angle coverage and a vertical aperture dimension of manageable proportions.

A rapid elevation pattern cutoff at the horizon is desirable to minimize ground reflected energy and thereby reduce the magnitude of lobing fades. A minimum 2 dB per degree cutoff rate appears adequate for most typical site environments. The low angle peak-of-beam gain can be maximized by reducing the gain of the antenna at the higher elevation angles. A high angle elevation pattern taper approximating a cosecant-squared function would provide satisfactory coverage for short range high angle targets while increasing the fade margin for long-range aircraft.

The above characteristics are realizable with omni antenna vertical apertures on the order of five feet. The mounting structure required for such an antenna should provide relatively little blockage to a closely positioned ATRBS antenna.

3.5 Receiver

The range requirement of the RBX coupled with the achievable gain of an omni-directional antenna imposes an added emphasis on the sensitivity of the RBX receiving channel. A low-noise pre-amplifier preceded by an RF path from the antenna consisting of a minimum of low loss components is essential to meeting the required overall system noise figure of 6 dB. Figure 5 illustrates an example of a front-end RF configuration with achievable component characteristics that is capable of meeting the RBX requirements.

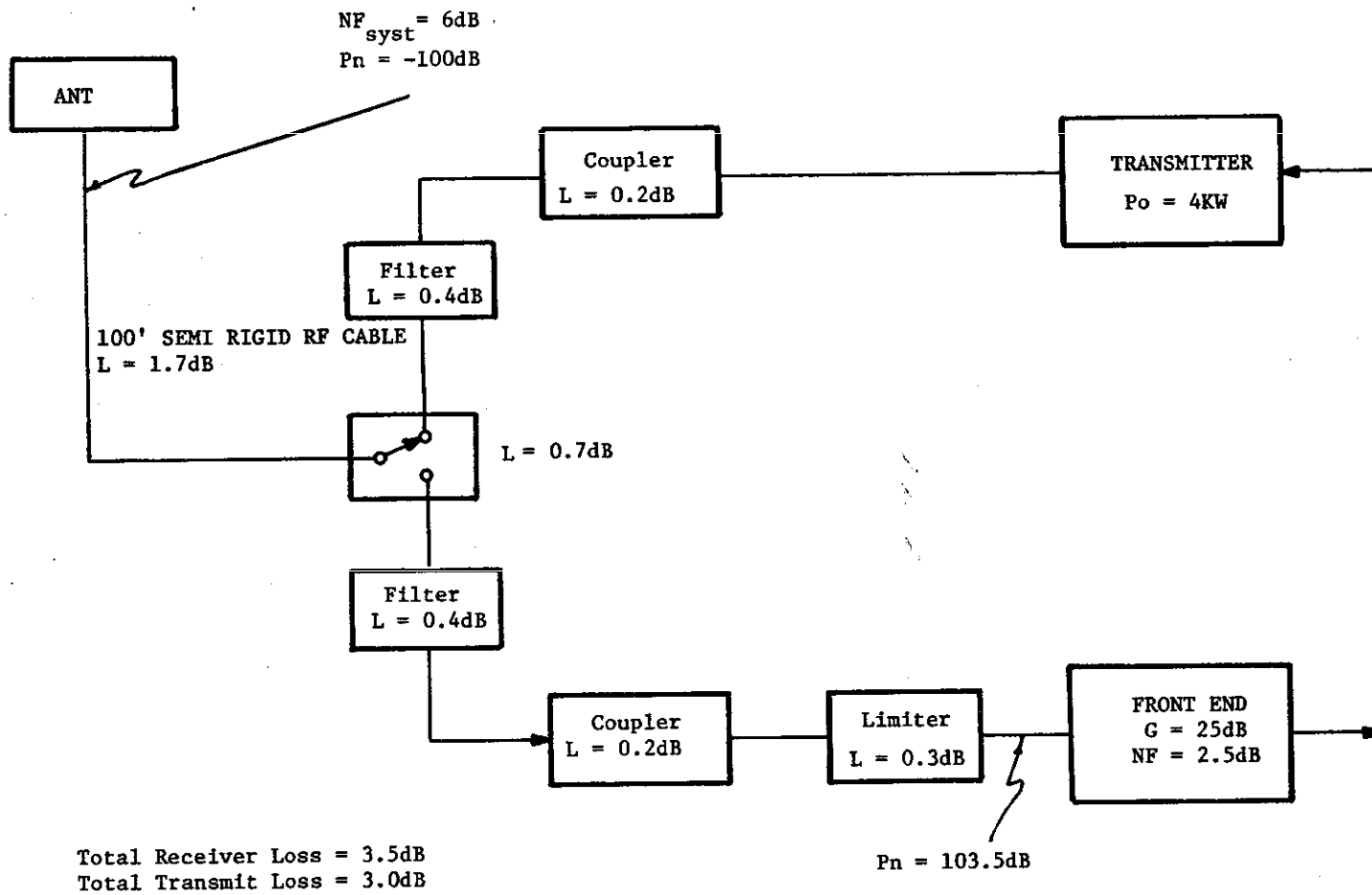

Fig. 5. Example of an RBX front end.

The RBX receiver provides a quantized video output consisting of the detected P1 and P2 pulse and demodulated data block associated with each received BCAS interrogation signal.

3.6 Interrogation Signal Processing

RBX signal processing operates on the receiver output signals to detect and decode the interrogations received from BCAS aircraft. An interrogation is detected on the basis of the 2-pulse preamble preceding the data block and also on the leading edge of the data block. The synch phase reversal, if located at the proper time with respect to the detected preamble, is used to synchronize the bit processing and decoding associated with the data block information. A time mark signalling the occurrence of the synch phase reversal is sent to transmission control to initiate the 500 μ sec delay interval for generation of a reply.

Message decoding uses the parity check code to detect errors in the demodulated message. Any error in the data block will manifest itself as an error in the address field as a result of the decoding process. If an error does occur, RBX will not recognize its discrete code in the address field, further processing associated with this interrogation will be terminated and a reply will not be issued. If the signal is verified as a valid BCAS interrogation, the digital message contents will be transferred to the RBX processor.

3.7 RBX Processor

In addition to the transmission control function described in paragraph 3.1, the RBX processing subsystem performs BCAS sensitivity level selection and provides the interface processing necessary for the transfer of data to and from ATC.

3.7.1 Sensitivity Level Selection

The RBX processor maintains eight different pre-defined range and altitude coverage maps of its surrounding area. Each map relates one of eight specific BCAS sensitivity levels to one of five specific regions of traffic density. Figure 6 illustrates one such coverage map surrounding an RBX. The particular sensitivity level assigned to each of the five regions and the range and altitude boundaries of each region depend on the terminal area traffic environment and will vary from site to site. Each of the eight prestored maps at a given site can be configured to represent one of a number of different traffic situations that are known to occur at a terminal area, such as an increase in weekend density, night-time versus daytime traffic and runway usage. ATC can then select a particular RBX map to match the current traffic situation.

BCAS-equipped aircraft are matched to one of the five map regions by the RBX based on the received position report. The BCAS sensitivity level command for that region is selected and sent to transmission control for inclusion in the RBX reply. The cross-hatched areas surrounding the nominal regional

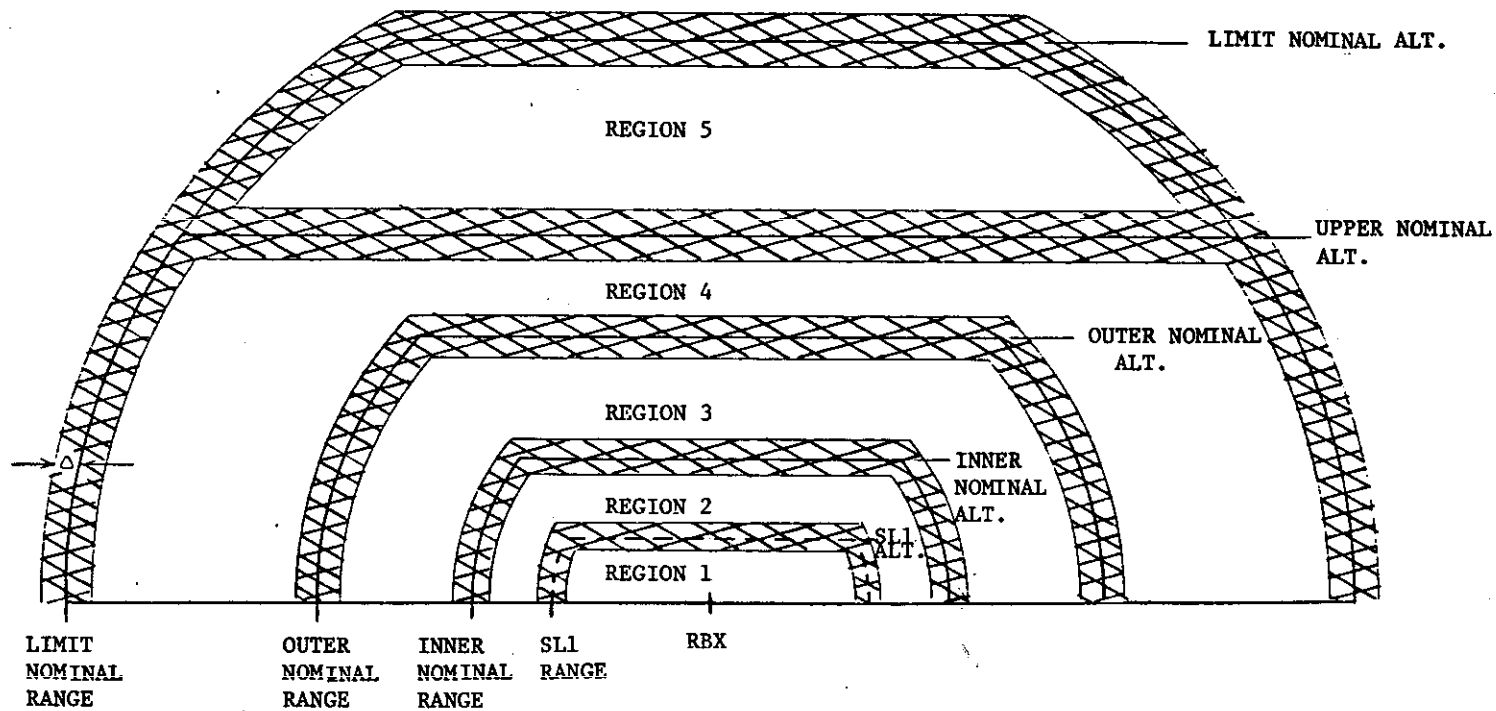

- BCAS chooses own sensitivity level outside Limit Range and Altitude.
- Region 1 is an optional sensitivity level 1 volume.

Typical Nominal Values

INNER RANGE - 2.0nmi
 OUTER RANGE - 10.0nmi
 LIMIT RANGE - 20.0nmi
 INNER ALTITUDE - 900 feet
 OUTER ALTITUDE - 10,000 feet
 UPPER ALTITUDE - 10,000 feet
 LIMIT ALTITUDE - 18,000 feet

Fig. 6. Side view of RBX coverage volume.

boundaries in Figure 6 signify regions in which "hysteresis" is applied to sensitivity level changes to prevent fluctuations between two levels. The nominal regional boundary dimensions are extended to overlap one another by an amount delta (Δ). An aircraft flying from region 3 to region 4 for example, and indicating operation at a sensitivity level associated with region 3 will be maintained at that level until its position report indicates transition through the extended boundary line of region 3 (i.e., nominal boundary $+\Delta$). It will then be commanded to the sensitivity level associated with region 4. An aircraft flying in the opposite direction (i.e., from region 4 to region 3) and indicating operation at the region 4 sensitivity level will not be commanded to the region 3 sensitivity level until it transitioned through the extended boundary line of region 4 (i.e., nominal boundary $-\Delta$). Thus, position estimation errors or flight path deviations for aircraft flying along a regional boundary could vary by as much as $\pm\Delta$ without affecting its sensitivity level selection.

The magnitude of the Δ associated with a range boundary and the Δ associated with an altitude boundary are each fixed values independent of the boundary dimension. The range and altitude Δ values, which are site adaptable, are chosen to exceed likely errors in the BCAS range estimate and the BCAS encoding altimeter output.

3.7.2 ATC Communication Data Link Interface

An RBX located in a terminal area containing an automated ARTS II or ARTS IIIA facility employs a duplex narrow-band telephone data link between the RBX processor and the ATC computer to enable two-way transfer of communication messages. The data interface uses the standard CIDIN protocol and formats for message transfer (ref. 4).

Validated interrogations from BCAS-equipped aircraft are checked for the presence of displayed resolution advisory codes. The advisory code together with the remaining contents of the MG mission field (except the SLR subfield) are formatted for transmission to ATC. In addition, once every four seconds, an RBX equipment status message is sent to ATC to report on the results of the RBX performance monitoring function described in paragraph 3.8.

The communication link also enables the ATC facility to remotely select a particular coverage map to match the current traffic environment. Map selection will be accomplished by one of the following two methods of operation:

- (a) Selection by map number of one of eight pre-defined coverage map configurations stored in the RBX.
- (b) Selection of up to eight map configurations by ATC. This requires that the individual regional altitude and range boundary values as well as the regional sensitivity levels be transferred to the RBX each time a different ATC map is selected. The advantage of this method is that ATC has the flexibility of generating any map configuration.

3.7.3 ATC Remote Control Interface

In some instances an RBX may be located in a terminal area that does not contain an automated ARTS facility and therefore can not employ the communications data link and formats described in 3.7.2. In these situations the RBX will provide the ATC facility with a remote control device which will enable ATC personnel to select any one of the eight pre-defined coverage maps stored in the RBX. The remote device will also have the capability of displaying RBX status information.

3.8 Performance Monitoring

The ability of the RBX ground equipment to perform its task of BCAS sensitivity level selection and ATC coordination is continually checked by the performance monitoring function. The following checks are performed once every 4 seconds:

- (a) Transmitter Peak Power Level
- (b) Receiver RF to Video Transfer Characteristic and Noise Level
- (c) System Clock Status
- (d) Transmission Control Messages to Modulator
- (e) Sensitivity Level Selection
- (f) Communication Interface

The results of these checks are evaluated to determine the status of the RBX equipment. Possible status conditions are:

- (a) Normal Operation (condition green)
- (b) Marginal Operation (condition yellow)
- (c) Failed State (condition red)

The status is reported to ATC once every 4 seconds along with the condition that defines the reason for a yellow or red status. A yellow condition is intended to alert ATC maintenance personnel to the fact that the RBX, although still able to meet its performance requirement, is approaching a marginal performance condition. A red condition is intended to alert ATC maintenance personnel to the fact that the RBX has failed to the point where it is no longer able to meet its performance requirement. A red condition indicates the need for immediate corrective maintenance.

4.0 RBX PERFORMANCE

This chapter summarizes the performance of the RBX in terms of link reliability in the presence of interference and fading. Interference originates from BCAS interrogators operating at 1030 MHz, from the adjacent ATCRBS sensor and to a lesser degree from other ATCRBS sensors. Fade effects occur mainly as a result of RBX antenna lobing and the orientation of the BCAS aircraft antenna.

4.1 Link Reliability

Link reliability is defined as the probability of a successful transmission between the RBX and a BCAS-equipped aircraft. Limitations on link reliability are due primarily to interference and fading.

4.1.1 Link Power Budget

Table 1 gives the RBX/BCAS link power budgets for a BCAS-equipped air carrier aircraft at 50 nmi range and at an elevation angle of 1 degree (7000 foot altitude). The RBX antenna is assumed to have a lower edge cutoff of 2dB/degree at the horizon. The power budgets for both links are balanced and provide essentially equal margins. At 1 degree elevation the margin is barely adequate to offset effects of severe fading and interference. For aircraft at 2 degrees elevation the margin is increased by an additional 1 dB. The table also illustrates the available margin for a BCAS-equipped general aviation aircraft. The interrogator power level of a BCAS GA aircraft is assumed to have a nominal value of 100 watts. As seen from the table, the downlink reliability for BCAS-equipped general aviation aircraft is severely affected as a result of a reduced interrogator power requirement.

4.1.2 RBX Antenna Lobing

Flat surfaces surrounding an antenna system give rise to in-beam reflections which result in lobing nulls in the elevation pattern of the antenna. Increasing the rate of the elevation cut-off at the horizon diminishes the depth of the lobing nulls. Figure 7, taken from Ref. 5 illustrates the lobing characteristics of three antennas having different rates of lower-edge cutoff in an environment that is moderately severe but not unusual for a terminal location. Moderate changes in antenna height shift the frequency of lobing within approximately the same envelope. An antenna with a 2 dB/degree cutoff could experience lobing fades as deep as 6 dB in the vicinity of 1 degree elevation. This is roughly equivalent to the nominal link margin. At 2 degrees elevation the potential lobing is reduced to approximately 4dB and the margin is increased by 1dB because of the increased elevation gain. This leaves 3dB of margin to offset the effects of the aircraft antenna.

4.1.3 Aircraft Antenna Fading

Active BCAS-equipped air carrier aircraft are assumed to employ antenna diversity (i.e., both a top and bottom mounted antenna). Figure 8 from Ref. 6 illustrates the probability of a fade greater than a given amount for an

TABLE 1
RBX/BCAS LINK POWER BUDGET

<u>Parameter</u>	<u>Uplink (1030 MHz)</u>	<u>Downlink (1030 MHz)</u>
Transmitter Power	66 dBm	57 dBm (50 dBm)*
Transmit Line Loss	-3 dB	-3 dB
RBX Ant. Gain (Peak)	6 dB	6 dB
Elevation Factor (at 1° Elev).	-5 dB	-5 dB
Aircraft Ant. Gain	0 dB	0 dB
Receive Line Loss	-3 dB	-3.5 dB
Path Loss (50 nm)	-132 dB	-132 dB
Receive Power	-71 dBm	- 80.5 dB (-87.5 dBm)
MTL (at receiver)	-77 dBm	-87 dBm
Nominal Margin	6 dB	6.5 dB (-0.5 dBm)

*The values in the parenthesis are for a BCAS-equipped general aviation aircraft with an interrogation power level of 100 watts.

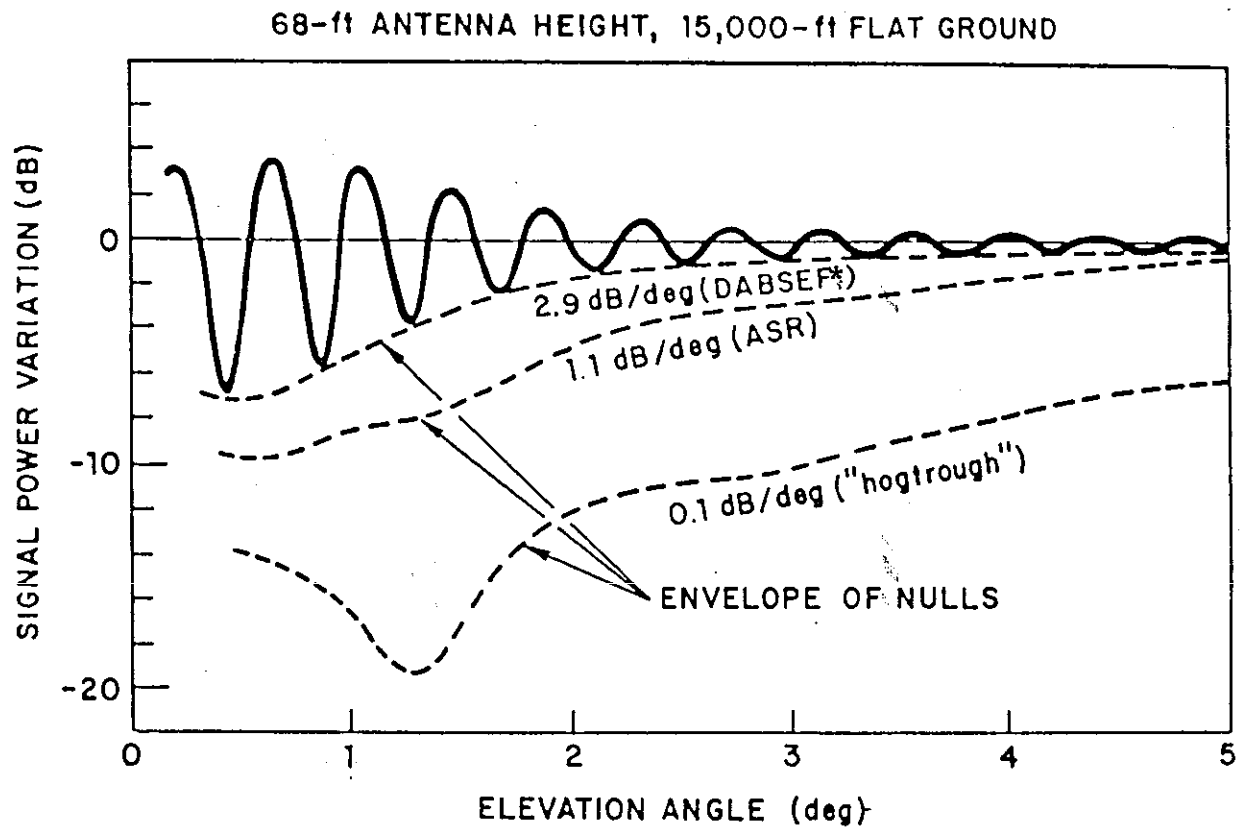

*Experimental DABS sensor at MIT Lincoln Laboratory

Fig. 7. Vertical lobing.

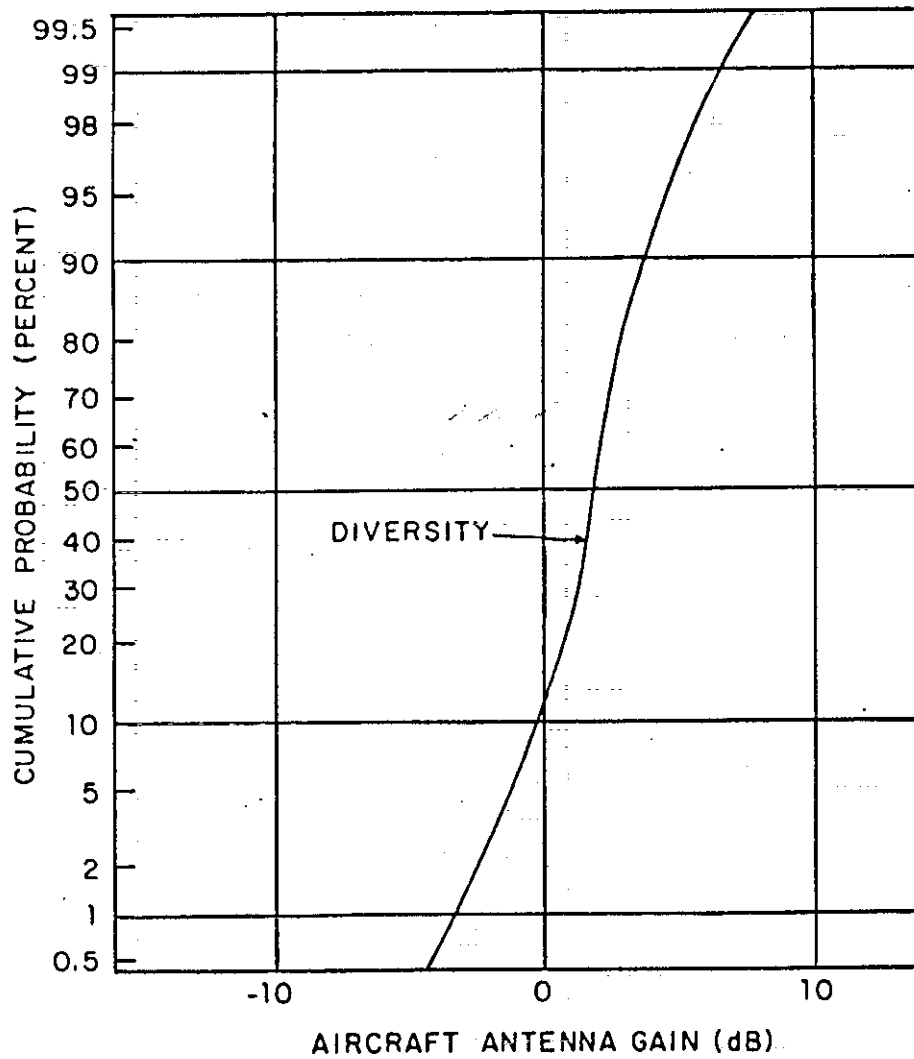

Fig. 8. Aircraft antenna summary statistics.

At some extensive terminal areas, additional outlying RBX installations may be required to provide the requisite coverage. The Los Angeles basin is an example of such a possibility. Although an outlying RBX would not necessarily have the interference problems associated with an airport site, it could be subjected to interference from a number of distant interrogators if its elevation were high enough. In 1976 the AMF recorded data on the 1030-MHz ATRBS interrogation environment in the Los Angeles area (ref. 7). Measurements were taken at a number of positions within the Los Angeles basin and at altitudes up to 7700 feet. The total interrogation rate observed at each of these locations did not exceed 200 interrogations per second. For an outlying RBX located at a high elevation in the Los Angeles area, the data indicates that the interference from a number of distant interrogators would not be nearly as severe as that from a single adjacent sensor.

Another source of 1030 MHz interference to the RBX is BCAS air-to-air interrogations. An absolute maximum upper limit on the effect of air-to-air interrogations can be established by considering the maximum interrogation rate imposed by the interference limiting specification in the BCAS National Standard (ref. 3). This specification limits the number of BCAS air-to-air interrogations which can be detected by an aircraft transponder with a nominal 30-nmi detection range to a rate of 570 per second. Since the RBX nominal detection range is 50 nmi, the air-to-air interrogation rate seen by the RBX could be at most 2.78 times higher or 1583 per second. Assuming that all of these transmissions are short DABS interrogations, the maximum probability that an asynchronous BCAS air-to-air interrogation will overlap any portion of a BCAS to RBX interrogation is 7.9%. As pointed out earlier, this value represents an absolute maximum BCAS air-to-air interrogation environment. It is highly unlikely that an RBX will ever encounter such an extreme situation.

A more reasonable BCAS air-to-air environment for the near future can be estimated by considering current traffic densities in the Los Angeles basin. Measured Los Angeles data presented in Ref. 8 indicates an average traffic density of 0.02 aircraft per nmi^2 within a 50 nmi radius or approximately 160 aircraft observable by an RBX. The data also indicates that localized traffic densities, for instance the number of aircraft within a 10 nmi BCAS range, varies from 0.01 AC/ nmi^2 to 0.1 AC/ nmi^2 depending on location. Using these figures and assuming that in the near future 10% of the total aircraft will be BCAS-equipped and 25% will be DABS equipped, the average air-to-air interrogation rate seen by the RBX will be more nearly 125/sec. or an order of magnitude less than the worst-case situation.

Figure 9 illustrates the probability of a successful RBX detection of a single preamble as a function of the power level at the receiver with and without interference. The interference is assumed to be a combination of the worst-case interference from the BCAS aircraft population plus the worst-case direct and reflected interference from two nearby ATRBS sensors. The solid curve is the probability of detecting three pulses (two preamble pulses plus the leading edge of the data field) in the presence of noise alone. The noise power at the receiver input is assumed to be -103 dBm. The dotted curve illustrates the effect of the interference and assumes that any overlap of the interfering signal with the BCAS to RBX interrogation will cause a BCAS to RBX link failure. This is again a worst-case assumption since some of the interfering signals, although overlapping, will not be large enough to cause

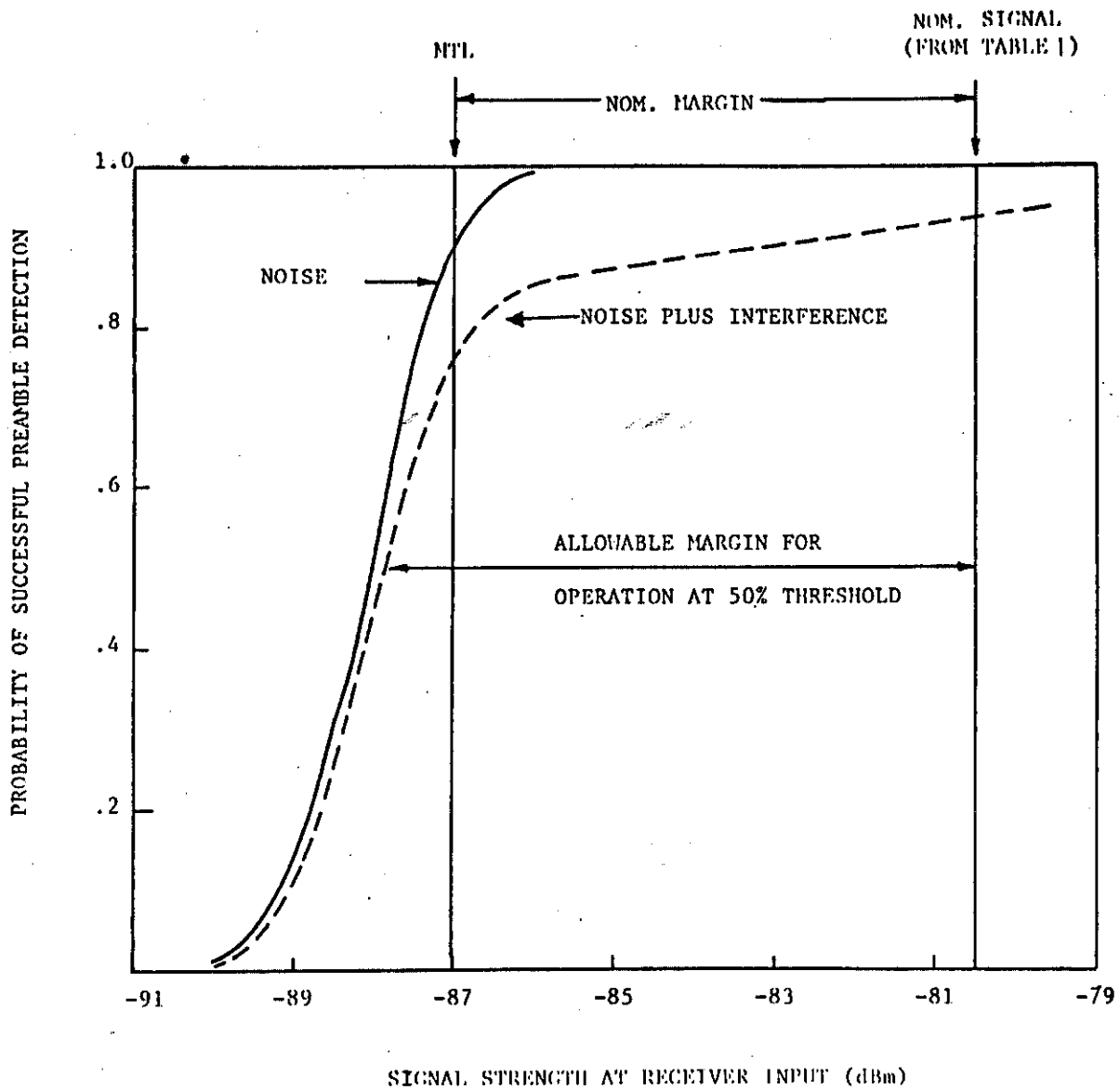

Fig. 9. Probability of RBX 3-pulse detection of a single BCAS interrogation in the presence of noise alone and noise plus interference.

a link failure. The result of the interference is to modify the noise curve everywhere by a factor of 0.86, the combined worst-case probability of detection in the presence of interference from air-to-air interrogations and two nearby sensors. The probability of a successful detection at the MTL signal level is reduced from 0.9 to 0.76 for a single interrogation.

Of more significance is the small amount of degradation at the 50% threshold. This threshold is increased by no more than 0.2dB as a result of the worst-case interference. Evaluation of receiver performance at the 50% threshold signal level is acceptable because of the ability of the BCAS aircraft to re-interrogate in the event of a miss. For example, the probability of a successful detection at this level for four interrogation attempts is 94% if the interference is statistically independent from one attempt to the next. This detection probability is equivalent to that achieved for a single interrogation at the nominal signal level.

4.1.5 Net Link Reliability

Operation at the 50% threshold allows nearly a 7.5 dB margin for RBX and aircraft antenna fades. From Figure 8 the probability that the aircraft diversity antenna gain is less than -1dB is approximately 5%. Reducing the margin by 1 dB leaves close to 6 dB for an RBX lobing fade. According to Figure 7 lobing fades greater than 6 dB are not apt to occur in a moderately severe environment at elevation angles above 1 degree. The result is that an RBX located adjacent to an airport surface should achieve a net link reliability of about 90% for diversity equipped aircraft at 50 nmi and elevation angles of at least 1 degree.

REFERENCES

1. D. C. Greenlaw and A. L. McFarland, "Interim Results of Analysis of Active BCAS Alert Rates Using Real Houston Traffic", MTR-79W293, The MITRE Corp. (June 1980).
2. "U.S. National Aviation Standard for the Discrete Address Beacon System (DABS)", Appendix 1 to DOT/FAA Order 6365.1 (9 December 1980).
3. "U.S. National Aviation Standard; Active BCAS Collision Avoidance System", DOT, FAA, Federal Register (October 27, 1980).
4. International Standards and Recommended Practices, Aeronautical Telecommunications, Annex 10 to the Convention on International Civil Aviation, Volume I, as amended by Amendment No. 61, dated December 1979, International Civil Aviation Organization (ICAO).
5. V. A. Orlando and P. R. Drouilhet, "DABS Functional Description," Project Report ATC-42A, Lincoln Laboratory, M.I.T. (11 April 1980).
6. W. H. Harman, "Effects of RF Power Deviations on BCAS Link Reliability", Project Report ATC-76, Lincoln Laboratory, M.I.T. (7 June 1977).
7. F. Nagy, Jr., "Uplink Coverage Measurements in the Los Angeles Area for Passive BCAS", Project Report ATC-81, Lincoln Laboratory, M.I.T. (7 November 1977).
8. W. H. Harman, "Air Traffic Density and Distribution Measurements," Project Report ATC-80, Lincoln Laboratory, M.I.T. (3 May 1979).