

A Summary of DABS Antenna Studies

J.-C. Sureau

3 February 1976

Lincoln Laboratory

MASSACHUSETTS INSTITUTE OF TECHNOLOGY

LEXINGTON, MASSACHUSETTS

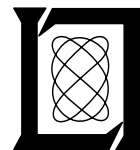

Prepared for the Federal Aviation Administration,
Washington, D.C. 20591

This document is available to the public through
the National Technical Information Service,
Springfield, VA 22161

This document is disseminated under the sponsorship of the Department of Transportation in the interest of information exchange. The United States Government assumes no liability for its contents or use thereof.

1. Report No. FAA-RD-75-112		2. Government Accession No.		3. Recipient's Catalog No.	
4. Title and Subtitle A Summary of DABS Antenna Studies				5. Report Date 3 February 1976	
				6. Performing Organization Code	
7. Author(s) J. C. Sureau				8. Performing Organization Report No. ATC-53	
9. Performing Organization Name and Address Massachusetts Institute of Technology Lincoln Laboratory P. O. Box 73 Lexington, Massachusetts 02173				10. Work Unit No. (TRAIS) 45364 Project No. 034-241-012	
				11. Contract or Grant No. DOT-FA72-WAI-261	
				13. Type of Report and Period Covered Project Report	
12. Sponsoring Agency Name and Address Department of Transportation Federal Aviation Administration Systems Research and Development Service Washington, D.C. 20591				14. Sponsoring Agency Code	
15. Supplementary Notes The work reported in this document was performed at Lincoln Laboratory, a center for research operated by Massachusetts Institute of Technology under Air Force Contract F19628-76-C-0002.					
16. Abstract A DABS antenna is characterized by the simultaneous availability of three beams: <ol style="list-style-type: none"> 1. A sum beam (Σ) through which all data is transferred. 2. A monopulse difference beam (Δ) used for target direction finding. 3. A control beam (Ω). Its function is to guarantee that all transactions occur in the main beam. <p>Whereas the desirable azimuth characteristics arise from the basic required functions and from the necessity to minimize the effects of the RF (target) environment, the desirable elevation features are such as to reduce the effects of the physical environment. Implementation options are very sensitive to the type (if any) of primary radar with which it is to be collocated.</p>					
17. Key Words DABS Monopulse Antennas Side lobe suppression			18. Distribution Statement Document is available to the public through the National Technical Information Service, Springfield, Virginia 22151.		
19. Security Classif. (of this report) Unclassified		20. Security Classif. (of this page) Unclassified		21. No. of Pages 50	

TABLE OF CONTENTS

	<u>Page</u>
SUMMARY	1
1.0 INTRODUCTION	3
1.1 Background	3
1.2 Organization of Report	4
2.0 THE ANTENNA AND THE SYSTEM	5
2.1 The Antenna and the DABS Sensor	5
2.2 The Antenna and Its Environment	5
3.0 ANTENNA DESIGN (DESIRABLE PARAMETERS AND FEATURES)	11
3.1 Sum/Difference Beams	11
3.2 Control Beam (Ω)	26
4.0 ANTENNA HARDWARE IMPLEMENTATION	29
4.1 Stand-Alone Beacon System	29
4.2 Retrofit on Existing ASR	33
4.3 New Terminal Radar	37
4.4 Retrofit on Existing ARSR	39
5.0 SITE CONSIDERATIONS	41
5.1 Characterization of Sites	41
5.2 Site Effects	41
5.3 On-site Optimization	42
6.0 ON-SITE MEASUREMENTS	45
REFERENCES	46

ILLUSTRATIONS

Fig.

1	DABS antenna/sensor interface	6
2	DABS transmission characteristics	7
3	Beacon antenna physical environment	8

ILLUSTRATIONS (continued)

<u>Fig.</u>		<u>Page</u>
4	DABS target capacity	12
5	Sidelobe distribution of several beacon antennas	16
6	Envelope of low-angle lobing minima	18
7	Elevation patterns and coverage diagrams	19
8	Effect of antenna gain on downlink reliability	21
9	Effect of high angle drop-off on gain.	22
10	Calibration induced cross-range error	25
11	Cylindrical reflector antenna	30
12	Typical reflector antenna with stacked feeds and separate omni (after Texas Instruments)	31
13	Typical planar array with separate omni (after Westinghouse)	32
14	ATCRBS hogtrough installed on ASR reflector	34
15	Open array installed on ASR-7 reflector (after Hazeltine)	35
16	Integral beacon feed for ASR-7; radome removed (after Texas Instruments)	36
17	Combined radar/beacon antenna for ASR	38
18	Influence of antenna tilt on low-angle lobing minima	43

TABLE

1	Sample Results of DABS Simulation (Effect of Sidelobes)	15
---	---	----

A SUMMARY OF DABS ANTENNA STUDIES

SUMMARY

Desired/Required Characteristics

A DABS antenna provides a DABS sensor with the required basic functional characteristics and minimizes the effect of the environment in which the system must operate. The antenna is characterized by the simultaneous availability of three beams identified as sum (Σ), monopulse difference (Δ), and control (Ω).

The sum beamwidth (3 dB) should fall between 2° and 4° and is the result of a trade-off between DABS interrogation capacity and direction finding accuracy. Irregular terrain environments favor the narrower beamwidths, while high densities of DABS-equipped aircraft favor the wider beamwidths. The sum beam azimuth pattern should exhibit not only moderately low peak sidelobes (25 dB), but also low average sidelobes (90% less than 35 dB over 360°); this latter is particularly important at elevation angles less than 10° . The preferred elevation pattern shape is one which, by making optimum use of the available aperture height, results in a high degree of cutoff of the pattern at the horizon and a gradual drop-off at high elevation angle. Specifically, the minimum gain in the presence of lobing fades should be maximized. The range of practical interest for the cut-off rate is between 2 and 4 dB/degree, as measured (by convention) at the -6 dB point. The monopulse difference azimuth pattern should cross over the sum pattern between the latter's -3 and -4 dB points; a sidelobe behavior comparable to that of the sum is also desired.

The control beam should exhibit an azimuth pattern that differs by as much of a margin as possible from the sum pattern (smaller in the main-beam, greater in the sidelobes). It should rotate with the directional beam so that the performance is scan independent. The control beam should preferably be derived from the same radiating structure as the directional beams so as to have the same free space elevation pattern and the same phase center. This essentially eliminates differential lobing between the directional and control beams and reduces the need for a high cut-off rate. In addition, integrally derived control patterns can usually be designed with a notch on boresight, thereby enhancing their desirability. If the control pattern is derived from a separate antenna, the higher cut-off rates are desired for both beams to minimize differential lobing.

Recommended Configurations

ASR Retrofit. There are three available options.

1. An "open" array which, if affordable and if demonstrated to endure in the field, offers the best overall performance.

2. A linear array, externally similar to the current hogtrough, but expanded to have monopulse difference and integral control patterns, is a moderate cost configuration that can be contemplated at sites where minimum lobing is present.

3. An integral beacon feed for the existing reflector is the lowest cost configuration, with or without integral suppression. It is almost as effective as the open array in reducing lobing but has a 4° beamwidth. It is recommended for sites where an open array is judged too costly.

New S-band ASR. In addition to the preceding configurations, a combined radar/beacon antenna, designed from the start as such, can be contemplated. A continuum of different possibilities exists, depending principally on the tradeoff between radar and beacon azimuth beamwidths. The most cost effective configuration would be a spoiled paraboloidal reflector with a combined radar/beacon focal feed.

New L-band ASR. The recommended implementation associated with a new L-band terminal radar, as derived from the ASR-() study, is an unspoiled paraboloidal reflector with a combined radar/beacon feed array of orthogonally polarized dipoles. This can be designed to incorporate all the desirable features of the radar and the beacon.

En-route Radar. Separate beacon array antennas (top, chin, or back mounted, depending on the nature of the site) are recommended as direct substitutes for the existing hogtroughs. Since the current and continuing operation of ARSRs will be with circular polarization, the successful implementation of an integral beacon feed remains questionable.

Stand-alone DABS System. Beacon antenna hardware developments of recent years have omitted what could very well be a more cost effective configuration. A spoiled cylindrical reflector, fed by a horizontal line source array, combines the excellent azimuth performance of an array with the lower cost of a reflector. The key to its acceptance lies in allowing the elevation pattern to drop off at the upper end of the coverage sector. It is recommended that no long-range commitments to other configurations be made without first pursuing this possibility.

1.0 INTRODUCTION

In the course of the DABS program, Lincoln Laboratory has performed a considerable amount of work on interrogator antennas. The documented results of this work appear in fragmented form in many different memos, working papers, and reports. It is hoped that this document will serve as a comprehensive summary of the past three year's efforts so as to provide guidelines for the specification, selection, and deployment of beacon interrogator antennas.

1.1 Background

Lincoln Laboratory's involvement in DABS antennas began with the formulation of the technical development plan (TDP). Based on the recommendations of the TDP, Lincoln Laboratory sponsored antenna design/cost studies carried out by Texas Instruments and Westinghouse during the latter half of 1972. This effort, the results of which are summarized in ATC-22, [Ref. 1], included separate consideration of stand-alone rotators, radar collocated antennas, and agile beam cylindrical arrays; its scope ranged from considerations of the antenna support tower at one extreme to monopulse signal processing at the other extreme. These studies continue to provide the largest single source of information available regarding performance vs the cost of candidate beacon antennas.

Concurrent with these studies, Lincoln Laboratory procured from Hazeltine a planar array for use as the interrogator antenna at the DABS Experimental Facility [Ref. 2]. This antenna featured sum and monopulse difference patterns with low sidelobes, and a constant gain elevation pattern with sharp horizon cutoff; an omni antenna with matched elevation pattern was also procured. It has been not only a highly successful tool at DABSEF, but has also served as a point of reference in the evaluation of antenna specification and implementation. As an outgrowth of the design/cost studies, Lincoln Laboratory sponsored the development by Texas Instruments of an add-on beacon feed for the ASR-7 radar antenna [Ref. 3]. This work was principally the basis for the ASR-7 and -8 modifications specified in the DABS Engineering Requirements. The development model antenna is currently integrated in the Transportable Measurements Facility (TMF), [Ref. 4], being assembled at Lincoln Laboratory to investigate the performance of a DABS sensor at a variety of sites.

Experiments performed at DABSEF have been directed toward a better understanding of the interaction of the antenna elevation pattern with the site characteristics as well as some of the unique problems associated with monopulse angle measurement with a scanning antenna. Lincoln Laboratory has also undertaken analyses in which the antenna performance is a dominant parameter, e.g., analyses concerning the impact of the beamwidth on channel management, algorithms for the processing of monopulse surveillance data, effects of sidelobes on interference and multipath signals, and link

reliability. Several analyses directed at optimizing site parameters have also been mainly concerned with antenna characteristics.

Although this report addresses itself to the design of a DABS antenna, it is generally recognized that the requirements for such an antenna would have many similarities to one designed for an improved ATCRBS sensor, especially one featuring monopulse direction finding. This being the case, Lincoln Laboratory's participation in the ATCRBS antenna improvement program has been pertinent to the DABS effort. Lincoln Laboratory's direct contributions to the FAA radar improvement program (i.e., Moving Target Detector development, "zoom" antenna proposal, and ASR-() study) [Ref. 5] have provided a unique perspective in the area of radar/beacon integration, which plays an important role in antenna implementation.

1.2 Organization of Report

Section 2.0 of this report provides a description of the antenna as a black box: its input/output relationship to a DABS sensor, and its interaction with the outside environment (physical and electromagnetic). Section 3.0 establishes a set of guidelines for what is considered desirable values of performance parameters and features, while outlining their justification. Section 4.0 is concerned with the options available for implementing the above, fully or partially, under a variety of deployment possibilities. Section 5.0 is comprised of observations regarding the predicted performance of antennas in the field, leading to some criteria for antenna selection and optimization of field adjustable parameters. Future plans for on-site measurements are presented in Section 6.0.

2.0 THE ANTENNA AND THE SYSTEM

The interrogator antenna is the device that constitutes the transition between the DABS system and the external environment. It is the primary means of control for the harmonious interaction of these two elements.

2.1 The Antenna and the DABS Sensor

As viewed from a DABS sensor and illustrated in Fig. 1, the antenna is a 3-port device that is used to radiate (at 1030 MHz) and receive (at 1090 MHz) beacon signals. The three ports are identified according to the azimuth radiation patterns that are associated with each:

- A "Sum" port (Σ) corresponding to a symmetric directional pattern typically a few degrees wide. It is through this port that essentially all data transfer takes place.

- A "Monopulse Difference" port (Δ) with an antisymmetric directional pattern commensurate in width with the Σ pattern. Signals received through this port are used, in conjunction with those from Σ , to determine the bearing angle of targets known to be in the main beam (sometimes referred to as "monopulse window").

- A "Control" port (Ω) with a broad pattern (often implemented as an omnidirectional pattern). This pattern is used in conjunction with the Σ pattern to provide the various transmit sidelobe suppression functions (SLS) and the receive sidelobe flagging functions (RSLs).

Because of the nature of the signal transmission and reception requirements of a DABS sensor (Fig. 2), all three antenna ports (and by inference, beams) must be available at all times.

2.2 The Antenna and Its Environment

2.2.1 Physical Environment

The sensor-to-target link is generally corrupted by the presence of the surrounding terrain which, by various processes, introduces self-generated spurious signals. The following list indicates examples of spurious signals, which are illustrated in Fig. 3:

- In-plane ground reflections, the sources of what is referred to as the "lobing phenomenon" because of the way they modify the effective interrogator antenna elevation pattern. The reflections are the primary source of link fades in the resulting null directions.

- Reflections from large objects or inclined surfaces, grouped as specular multipath, which tend to cause errors in the angle-of-arrival measurements (reception) or false out-of-beam interrogations (transmission).

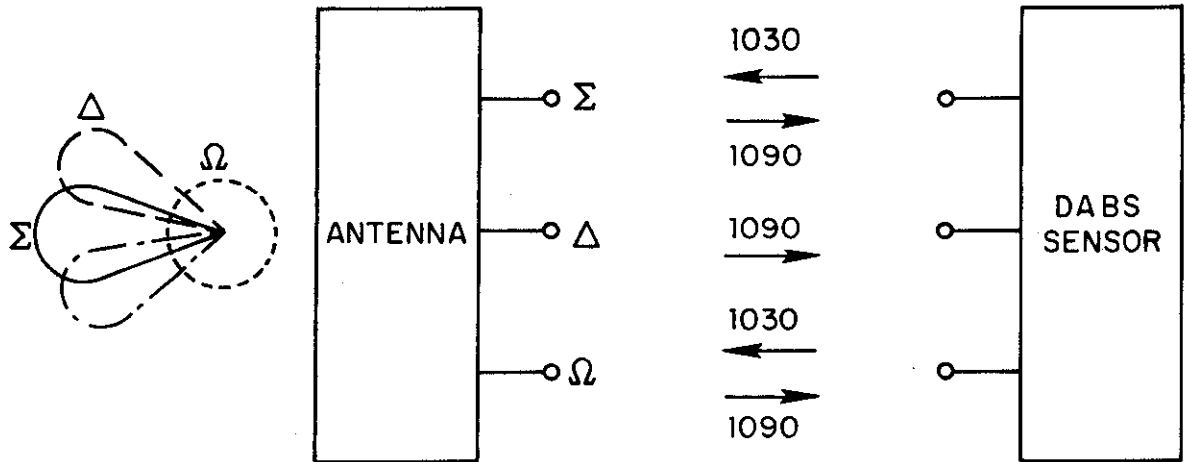
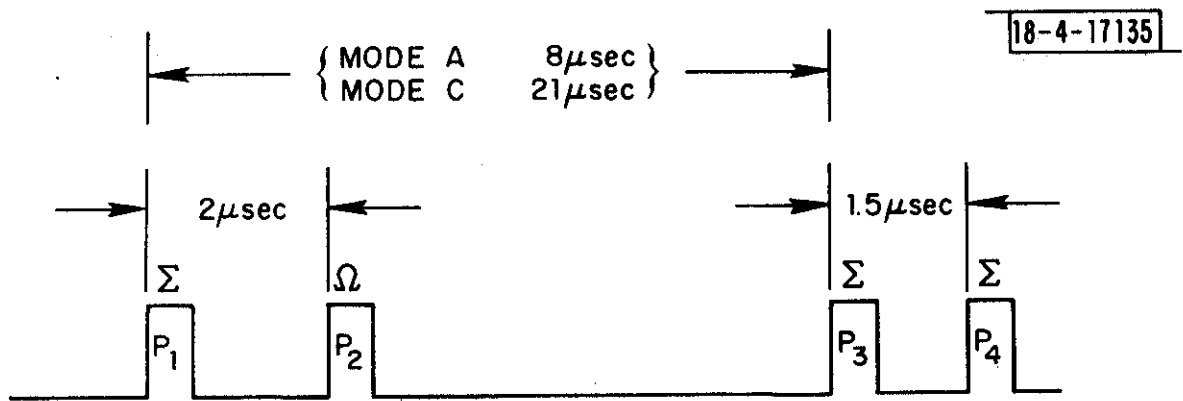
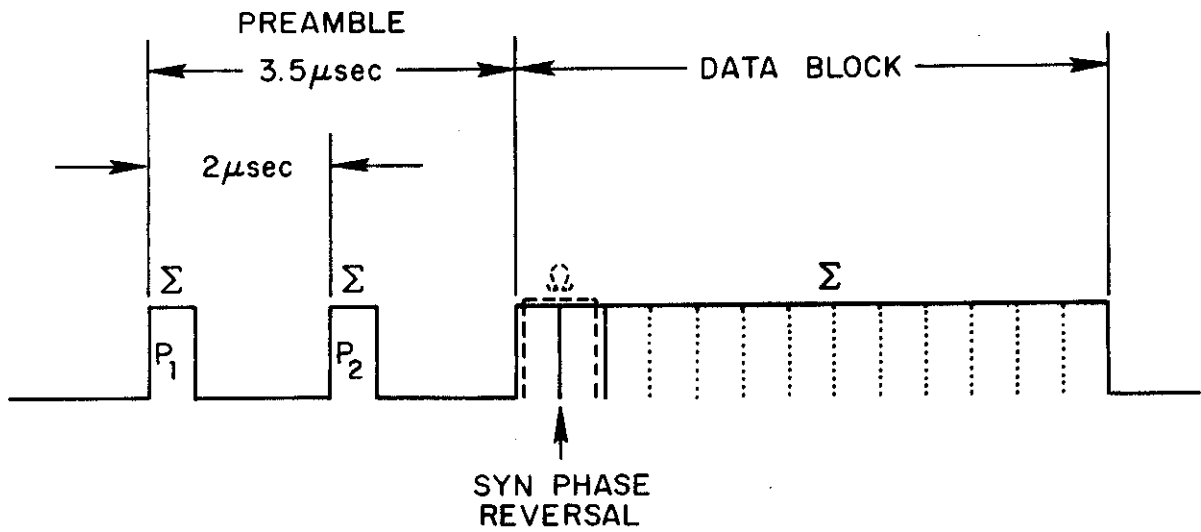

Fig. 1. DABS antenna/sensor interface.



(a) ATCRBS/DABS ALL-CALL



(b) DABS

Fig. 2. DABS transmission characteristics.

18-4-17329

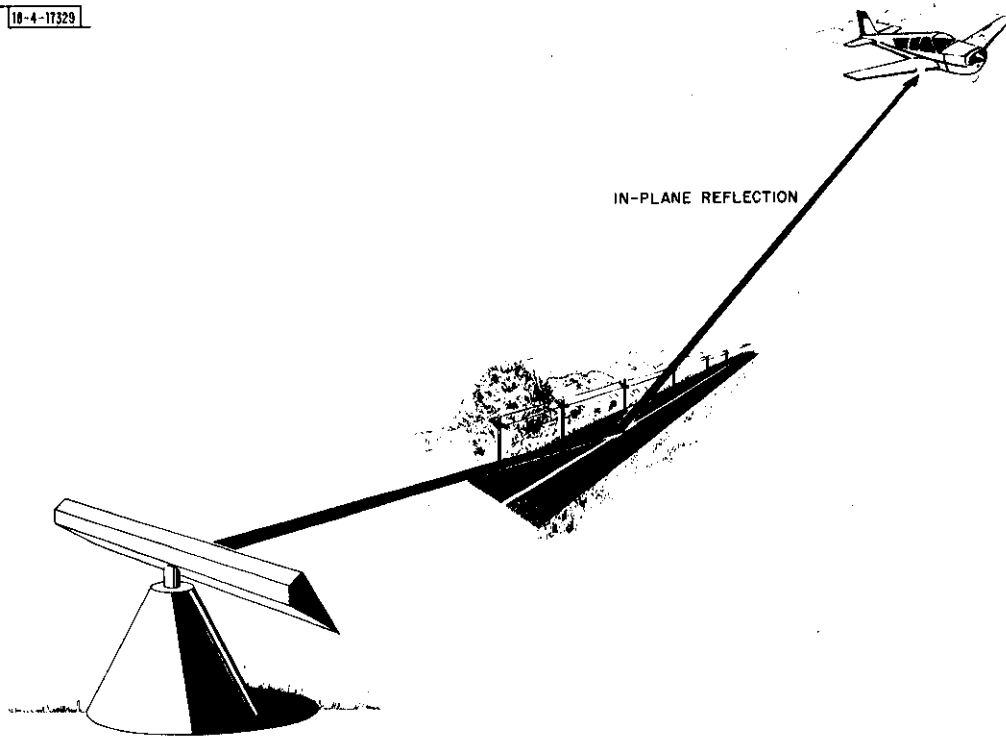

18-4-17327

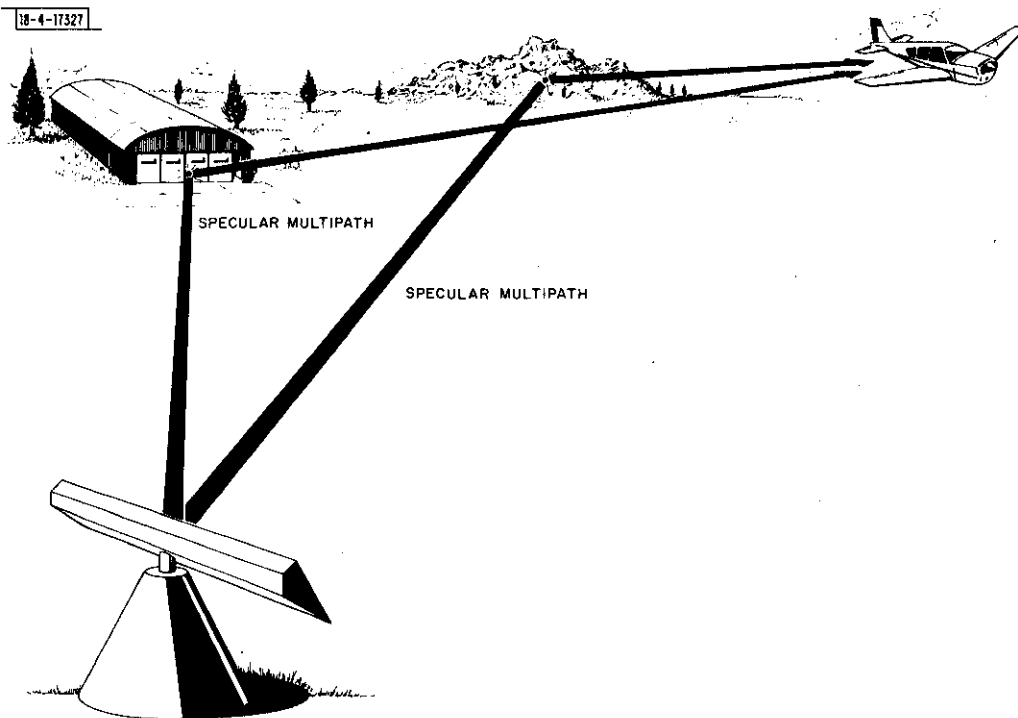
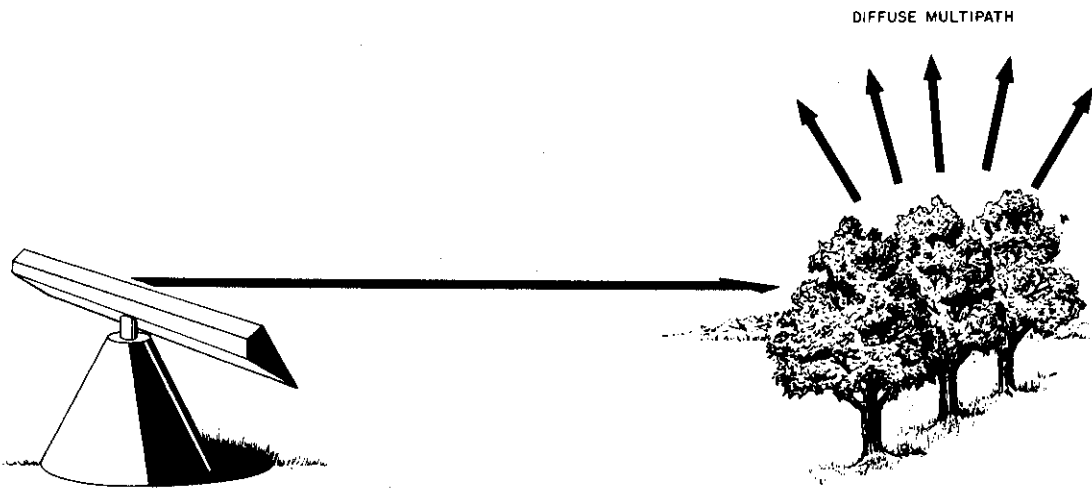

Fig. 3. Beacon antenna physical environment.

18-4-17330



18-4-17328

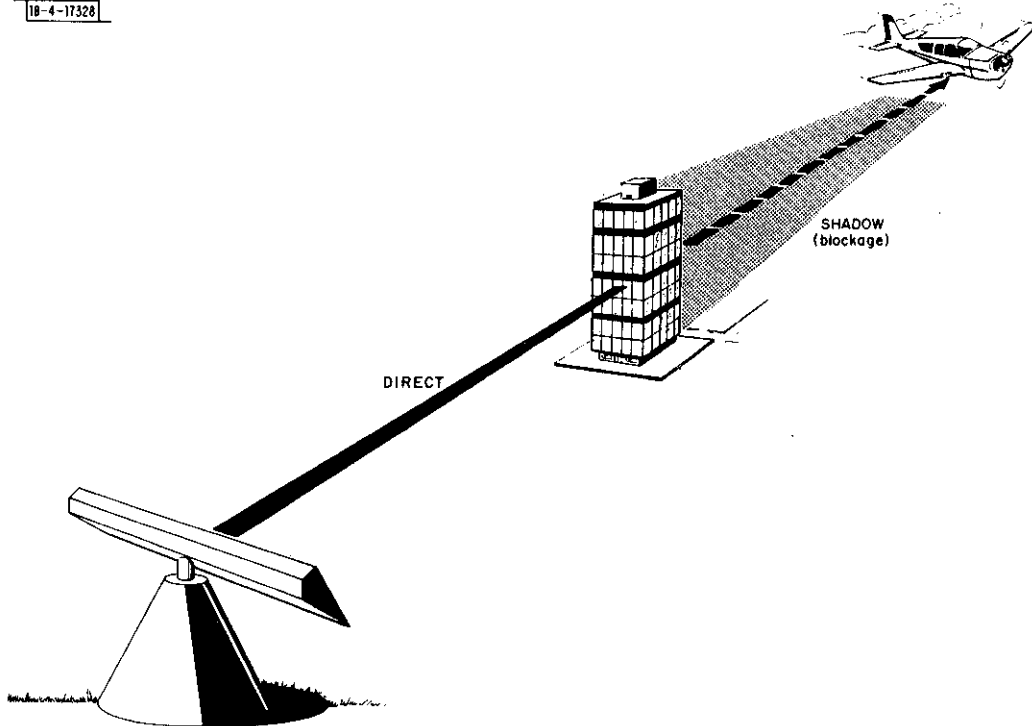

Fig. 3. Continued.

- Scattering from randomly distributed surface roughness elements, referred to as diffuse multipath, which can degrade the definition of pulse shapes.

- Complete or partial blockage of the line-of-sight ("shadowing") between the interrogator and the target, causing both fades and direction finding errors.

2.2.2 Electromagnetic Environment

The beacon electromagnetic environment is one in which both the interrogator and the target are, in fact, surrounded by other interrogators and targets. This means that an interrogator is receiving signals not only from a desired target(s) but also from other targets, within its range and field of view, responding to other interrogators. Likewise, a target is receiving signals from all interrogators within its field of view.

In view of all other spurious signals potentially generated by either interrogator self-interference ("multipath") or beacon system self-interference ("interference"), it is imperative that the interrogator antenna be designed to minimize their effect.

3.0 ANTENNA DESIGN (DESIRABLE PARAMETERS AND FEATURES)

In this section, various system performance issues, which impact on the antenna conceptual design, are discussed. Desirable numerical values (or range of values) for the essential antenna performance parameters and design features are deduced.

3.1 Sum/Difference Beams

In many respects, there is a natural association between the sum and difference beams which makes it most convenient to discuss them jointly as a complementary pair.

3.1.1 Azimuth Beamwidth

The sum beam azimuth beamwidth is undoubtedly the dominant antenna parameter. Its impact on the system performance lies in two main areas: (1) time on target, and (2) direction finding accuracy. Whereas the former consideration leads to the desirability of wide beamwidths, the latter favors narrower beamwidths; hence, a major trade-off area is identified.

3.1.1.1 Time on Target

Time on target influences primarily the number of aircraft the sensor can handle in the DABS mode, referred to as "DABS capacity." Those transactions occur during the intervals between periods dedicated to ATCRBS and, therefore, are dependent on the ATCRBS PRF and instrumented range. Typically, four ATCRBS interrogations across the beam are necessary for reliable target declaration with a DABS processor (two mode As and two mode Cs); for a 15-rpm rotation rate, the required PRF is then $360/BW$. Capacity is also dependent on the type of DABS transactions that occur. As a figure of merit, a "saturated" situation is defined as one in which only two Comm A transactions are attempted per aircraft. Under this condition the maximum DABS capacity can be parametrically summarized as indicated in Fig. 4. For a 100-mile sensor, the nominal design at the 4-second data rate, 2° represents a reasonable selection of minimum desirable beamwidth, leading to a saturation capacity of approximately 20 targets per degree.

3.1.1.2 Direction Finding Accuracy

For the sake of simplifying the discussion without affecting the resulting conclusion, what has previously been referred to as the "inherent accuracy" will be considered here. The only signal present is therefore the direct transponder reply. The design goal for this inherent DF accuracy has been 0.1° rms for a single reply, from a target at maximum range and within the 3-dB beamwidth.

The antenna, per se, does not contribute any appreciable inherent errors. However, when the antenna is coupled to a monopulse receiver, the

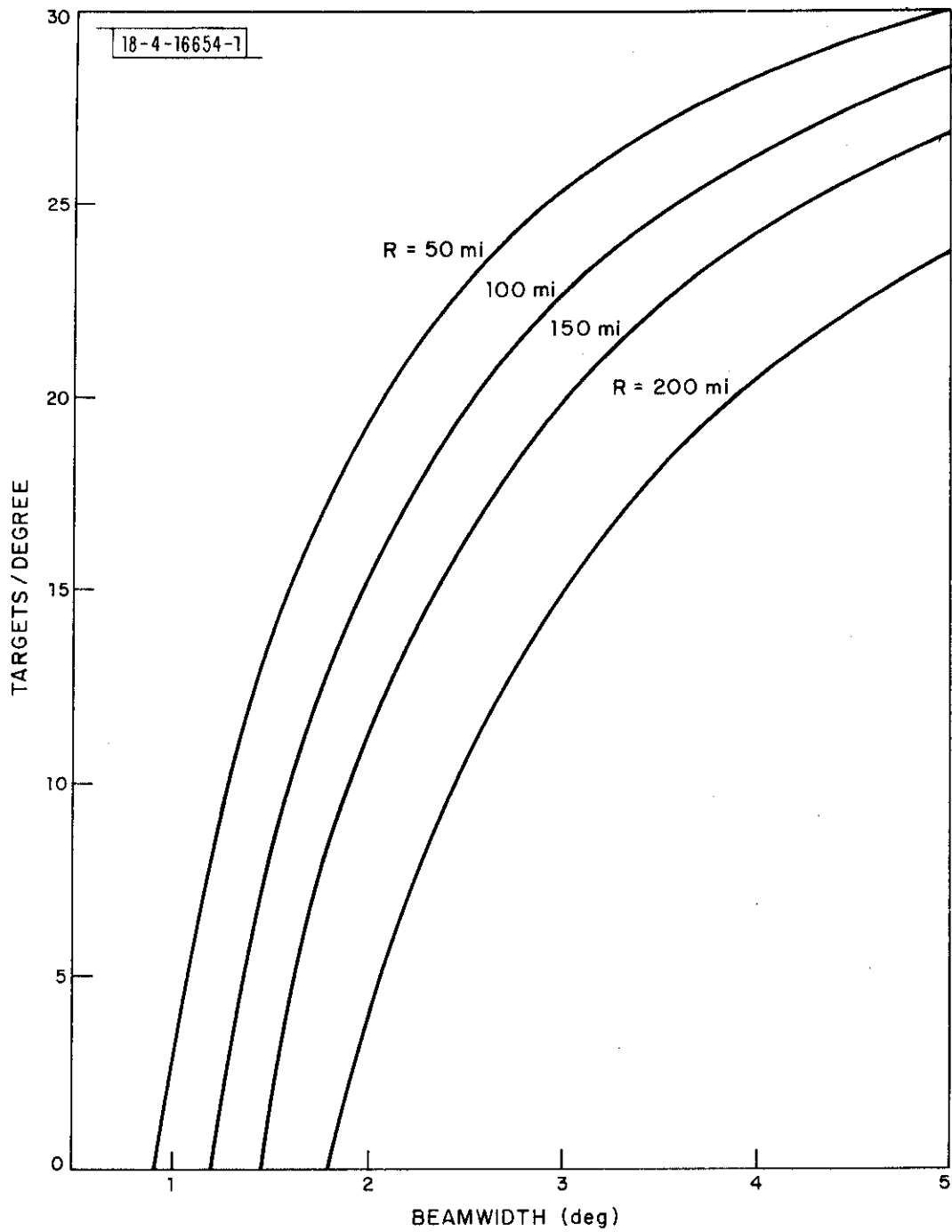

Fig. 4. DABS target capacity.

errors tend to be proportional to the beamwidth. This enables one to characterize the system by a "beam splitting" accuracy, which is the ratio of the beamwidth to the rms error. The receiver noise contribution does not quite follow this rule in view of the fact that, in addition, the signal-to-noise ratio varies as $1/BW$; this error source is not expected to be significant because averaging of samples within the reply will be used. Primary sources of direction finding errors ("inherent") are transponder frequency (6-MHz spread), dynamic range of received signal, pulse width variation, sample timing, hardware drifts, i. e., variations that cannot be calibrated out, even on a perfect range.

Although the beamsplit factor is primarily determined by the monopulse receiver characteristics, it is also, in principle, dependent on the difference pattern shape. The steeper the on-axis slope, the more accurate the system. It is a common practice to characterize the slope by the location of the sum-to-difference cross-over point ($\Delta/\Sigma = 1$); this essentially specifies the difference pattern beamwidth relative to that of the sum. The desirable location of the cross-over point varies between -3 dB on the sum pattern (this makes the aperture width required for the difference compatible with that required for the sum) and -4 dB (anything less implies that the aperture is inefficiently utilized). This desirable range of cross-over values results in a small variation in the beamsplit factor; the sum beamwidth emerges, therefore, as the dominant antenna determinant of inherent accuracy. Lincoln Laboratory's experience with the monopulse receiver and antenna at DABSEF indicates that it is reasonable to expect field deployable equipment to achieve a beamsplit factor of 40:1. Therefore, the conclusion is that a 4° sum azimuth beamwidth is the upper tolerable limit consistent with the 0.1° rms desired inherent direction finding accuracy. The overall conclusion is that a DABS sensor performs satisfactorily with an antenna azimuth beamwidth (3 dB) between 2° and 4° .

3.1.2 Azimuth Sidelobes

The driving requirements, as far as Σ sidelobes are concerned, are derived from considerations of downlink interference. Analysis of aircraft distributions indicates that, typically, 99% of line-of-site targets are below 10° , and 75% are below 3° . Therefore, as far as interference is concerned, it is the low elevation angle (less than 10°) receive sidelobes that are of interest. The transmit sidelobe characteristics at the aforementioned angles will generally follow the same behavior, but requirements tend to be less stringent because of the use of SLS. At high elevation angles, sidelobe requirements are influenced mainly by proper SLS and RSLs behavior and will be included in the discussion of the control pattern.

Traditionally, beacon antenna sidelobes have been specified in terms of their peak values. Although it is prudent engineering practice to specify reasonably low peak sidelobes, it is not sufficient. Many interference phenomena are more dependent on the statistical behavior of the sidelobes over

the full 360°. This is demonstrated by the results of the DABS processor simulations in which the sidelobes in the rear 180° sector ("backlobes") are modeled as a constant specified level, and the forward sidelobes are tapered according to Taylor illuminations [Ref. 6]. The postulated fruit environment is that generated by 500 ATRBS transponders located within 170 miles of the sensor; this corresponds to an unprocessed incident fruit rate of 70,000 per second (Philadelphia environment). Typical simulation results (Table 1) corroborate that correct decoding is, for example, more critically dependent on the average backlobe level than it is on the forward peak sidelobe level. This takes on practical significance when examinations are made of the measured sidelobe distributions of several existing beacon antennas. This is illustrated in Fig. 5 indicating the probability distribution functions of the pattern level (including main beam) at approximately a 5° elevation angle for these various antennas. The number next to the identity is the peak sidelobe level. The ATRBS-only reflector antenna illustrates an earlier observation that peak sidelobes are not sufficient criteria for guaranteeing adequate performance. Based on the realized sidelobe distribution of the better performing antennas, it is reasonable and desirable to specify that the probability of obtaining a pattern level greater than -35 dB is less than 10%; this would be in addition to a maximum sidelobe specification of -25 dB.

Given an antenna that produces sidelobes of a given characteristic, it is usually possible to generate a difference pattern with a similar behavior except for a possible general degradation of a few dB. Although the effect of interference on monopulse accuracy seems less serious than on decoding, it is still advisable to specify low difference pattern sidelobes because the cost penalty for new antennas is minor.

3.1.3 Horizon Cutoff

Many problems of the current ATRBS system have been attributed to the broad elevation pattern of the standard FAA 7202 linear array. The dominant trend in new beacon antenna design has therefore been primarily concerned with elevation patterns having a high rate of cutoff near the horizon (typically a few dB/degree).

In the DABS system, the principal justification for a high cutoff rate is the control of lobing fades. Although this is not the only aspect of the performance that benefits from a high cutoff rate, it is the most significant. Other current ATRBS problems will be alleviated by this feature but will rely on other techniques as primary control mechanisms, e.g.,:

- Suppression of valid targets in the main beam by differential lobing between the directional and omni antennas
- Interrogations in the sidelobes for the same reason as above
- False targets resulting from interrogations via reflections from nearby terrain or obstacles.

TABLE 1
 SAMPLE RESULTS OF DABS SIMULATION
 (EFFECT OF SIDELOBES)

Sidelobe (dB)	Backlobe (dB)	Prob. Failure (%)	Azimuth rms error (deg)
20	30	7.0	0.05
25	30	7.0	0.06
30	30	8.5	0.03
20	40	6.0	0.05
25	40	5.0	0.04
30	40	5.0	0.04

Note: The above are results of 300 Monte Carlo trials each.

SNR = 30 dB

Beamwidth = 4° (3 dB)

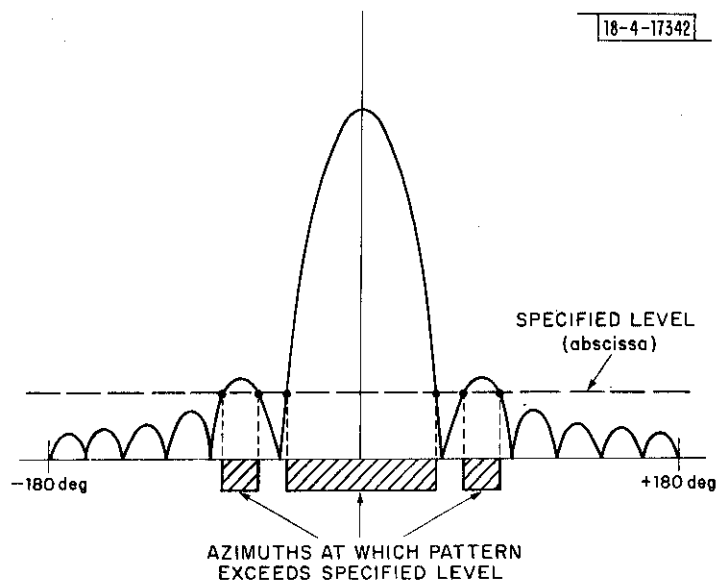
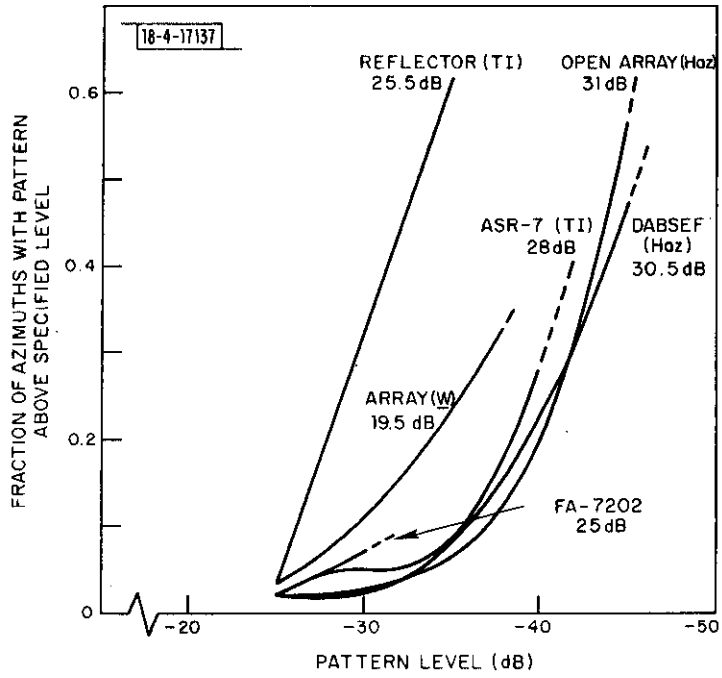

Fig. 5. Sidelobe distribution of several beacon antennas.

Lobing fades are created by in-plane scattering from the surrounding terrain and, therefore, are strongly dependent on its characteristics. However, for purposes of establishing design guidelines, a flat smooth earth model (although only occasionally existent in the real world) is a convenient and reasonable basis of comparison for various antenna designs. Although the lobing pattern is dependent on the antenna height above ground, the envelope of the lobing minima is not. It is plotted in Fig. 6 for a generic pattern shape with varying values of cutoff rate (as measured at the -6 dB point).

It is difficult to establish a well justified performance criterion for a sufficient amount of cutoff. In experimental beacon antennas, which have been built in the last few years, the cutoff rate was simply maximized, subject to other constraints (physical or financial). However, it is worth noting that there is a danger in too much cutoff because of difficulties in predicting the beam pointing direction in the field. Protection must be taken against the danger of insufficiently illuminating low elevation angles and placing too heavy a burden on the site commissioning process. With a beam pointing confidence of $1/2^\circ$, a cutoff rate of 4 dB/degree, at the -6 dB point, is an adequate maximum tolerable value. The selection of -6 dB as a reference point should not be construed as implying that this is the universally recommended point to aim at the horizon. It is only a convention by which different antennas can be compared with respect to their cutoff properties (similar to the method that beamwidth is usually measured at the -3 dB points). The issues involved in the selection of beam tilt are presented in Section 5.0, in view of the fact that they are more related to siting than to antenna design per se.

3.1.4 Elevation Coverage Pattern

While there is general agreement for the desirability, if not necessity, of an improvement in the rate of cutoff of the elevation pattern near the horizon, the shape of this pattern in the coverage region has been the subject of some controversy. With the current FA-7202 antennas, this is not an issue because almost no pattern shaping is possible. A number of range dependent signal management techniques are presently used in ATCRBS which, in fact, exploit the nearly constant gain elevation pattern. In the uplink, Reply Rate Limiting and Dynamic Desensitization have the effect of favoring strong signals (nearby interrogators) relative to weak signals (far interrogators), in a situation when such signals compete for transponder replies. Sensitivity Time Control (downlink) helps to reduce the detectability of undesired replies.

With the larger vertical apertures inherently required for higher horizon cutoff rates, the possibility exists for obtaining a variety of elevation pattern shapes in the remainder of the coverage region. This possibility must be examined from the viewpoint of impact on system performance and implementation. For a given horizon cutoff rate, there are two extremes for desirable elevation patterns: constant gain, which provides equal signals for all targets at the same range, and a cosecant-squared drop-off, which provides equal signals for all targets at the same altitude as illustrated in Fig. 7.

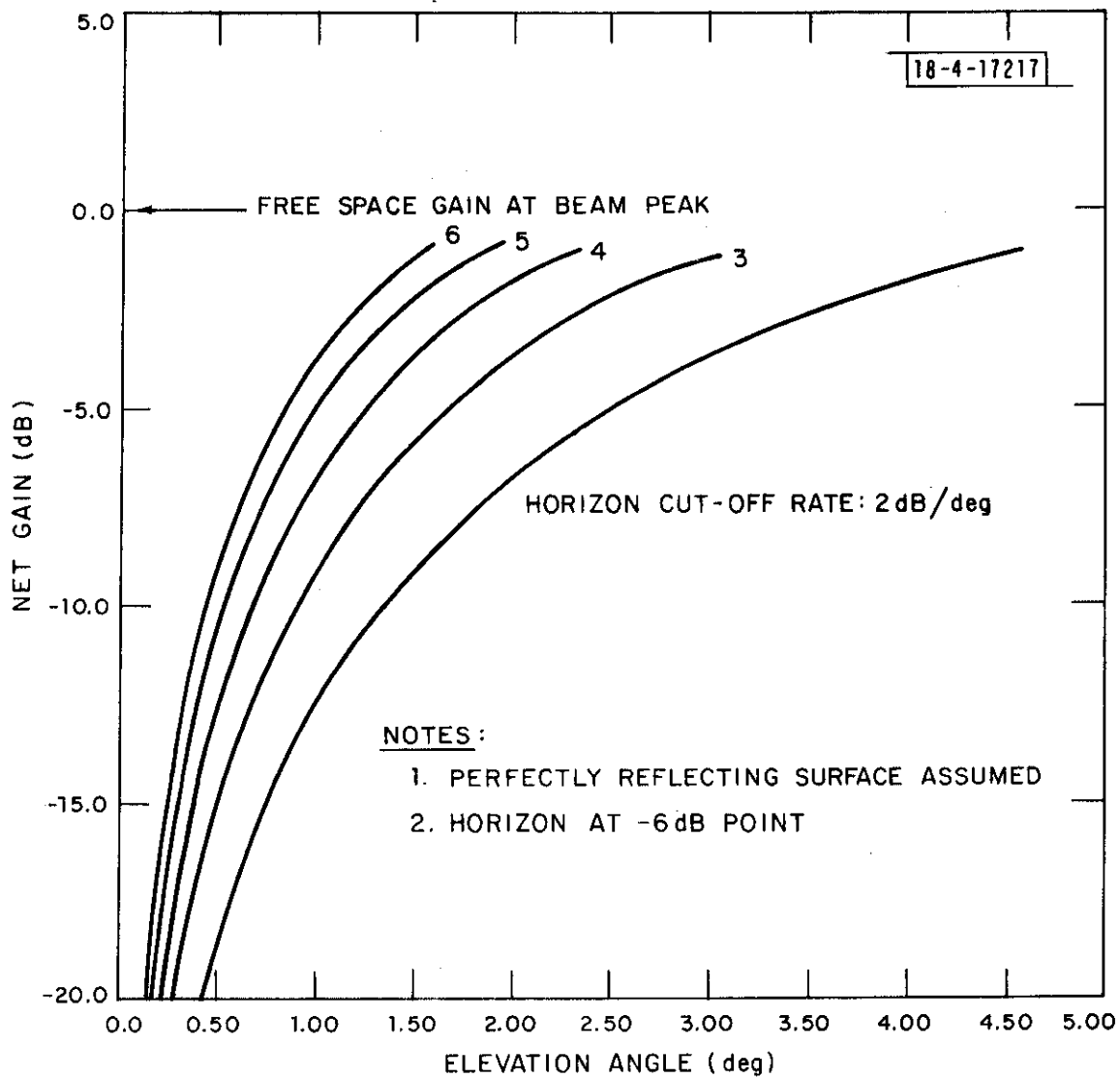

Fig. 6. Envelope of low-angle lobing minima.

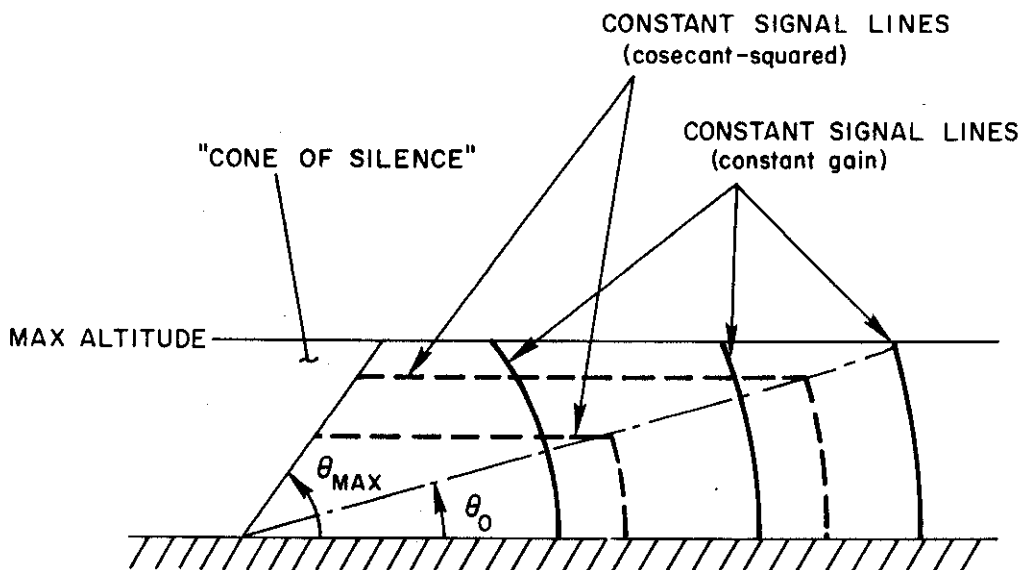
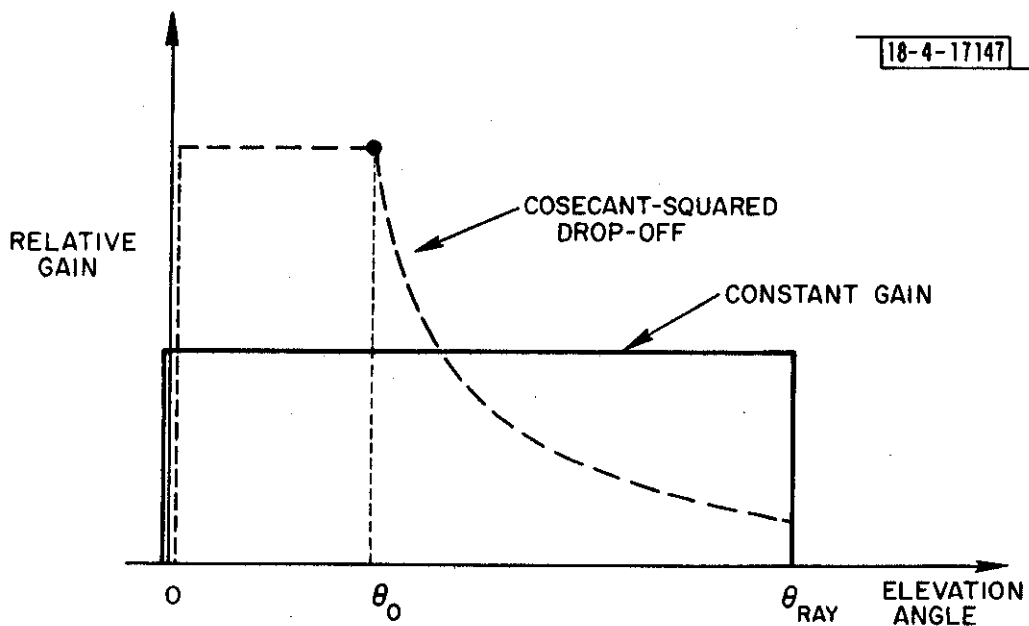

Fig. 7. Elevation patterns and coverage diagrams.

One question that immediately arises is: Why, in fact, consider anything other than constant gain? From a performance viewpoint, the answer is the absolute gain penalty incurred with such a design; from a hardware viewpoint, it is the potential cost savings resulting from simpler realization than otherwise required for constant gain.

One measure of the significance of peak antenna gain in reference to the system performance is provided in Fig. 8, which indicates that if good low angle coverage is to be provided on general aviation aircraft (less than 1% failure in surveillance update on a single interrogation), antenna gain cannot be wasted. Figure 9 illustrates the amount of gain improvement that can be achieved by pattern shaping. Although it is probably not desirable to permit either a dropoff as severe as cosecant-squared or a sector beam with constant gain, attractive compromises do exist. Even if there is a necessity to extract as much gain as possible, it is still desirable to consider allowing the pattern to drop off at higher elevation angles because spoiled reflector implementations can then be considered. The potential cost savings that these usually offer is sufficient reason to permit less rigid requirements for the upper angle pattern shape.

With an allowable dropoff of typically 8 to 10 dB, what problems are introduced? First, the observation can be made that the unprocessed signal dynamic range is unchanged; the minimum signal corresponds to the worst fade at maximum range, and the maximum signal comes from near the beam peak at minimum range. The instantaneous dynamic range is determined not only by the free space pattern but also by the lobing (or other) fades. With the FA-7202, lobing is the prime antenna caused contributor to the dynamic range. Even for an antenna with an acceptable cutoff, lobing fades are still inevitable at low angles. Therefore, as long as the pattern has a moderate dropoff (8 to 10 dB), the instantaneous dynamic range is not increased over that which it would be with a constant gain pattern (no significant lobing fades are expected at high angles). Hence, any STC that does not suppress targets in a moderate fade condition will also be appropriate for high elevation angles. It can also be noted that within the elevation 3-dB beamwidth and therefore within the portion of the coverage volume where most traffic is found, the "cosecant-squared" pattern results in the same range dependence of signals as the constant gain pattern. In view of the fact that the vast majority of aircraft are within that sector, the extent to which reply rate limiting (RRL) and Dynamic Desensitization are helpful in controlling fruit is essentially unchanged. In addition, by not allowing the pattern to drop off as rapidly as cosecant-squared, RRL and Dynamic Desensitization will remain effective, even for an aircraft at high altitude, in favoring the closest interrogator.

3.1.5 Special Monopulse Features

In addition to the previous antenna performance features, which tend to be conventional, the off-boresight monopulse operation will involve some additional requirements which are presented in the following subparagraphs.

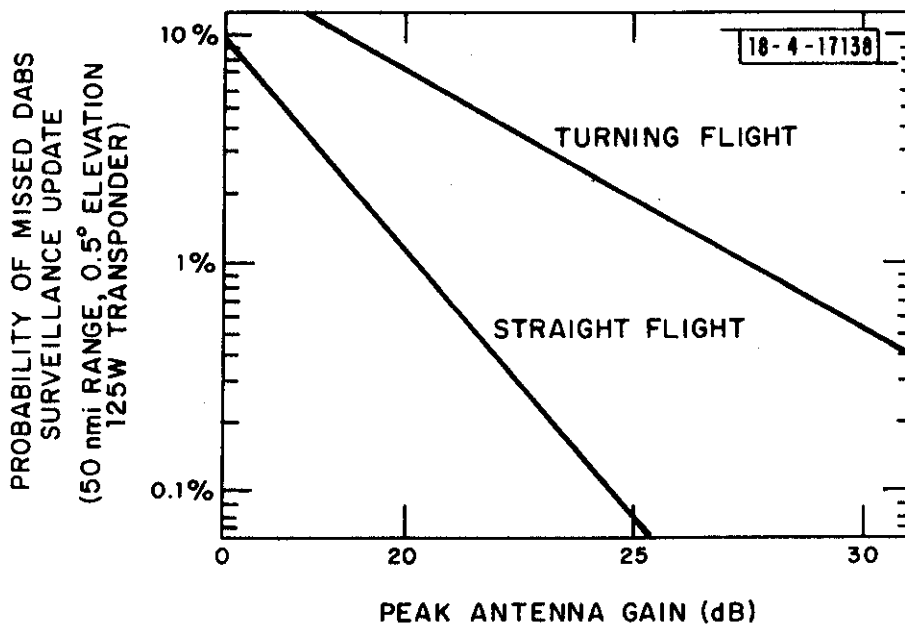
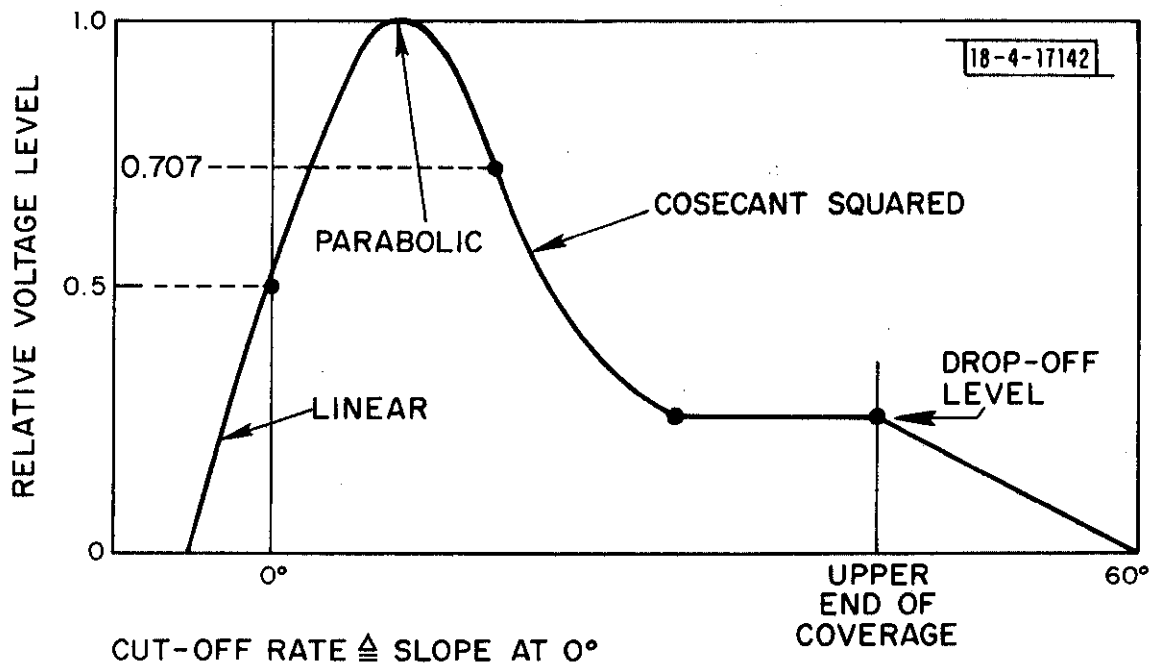
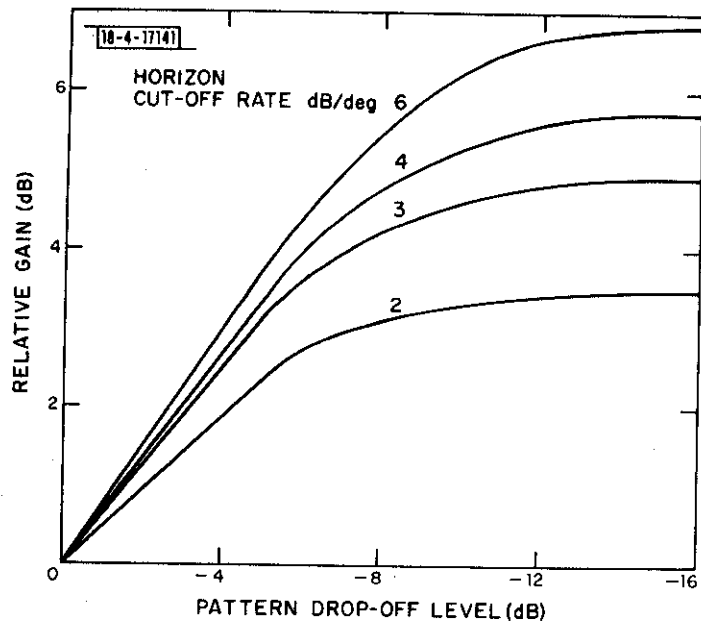

Fig. 8. Effect of antenna gain on downlink reliability.



(a) Shaping factors.

Fig. 9. Effect of high angle drop-off on gain.



(b) Relative gain for 30° coverage.

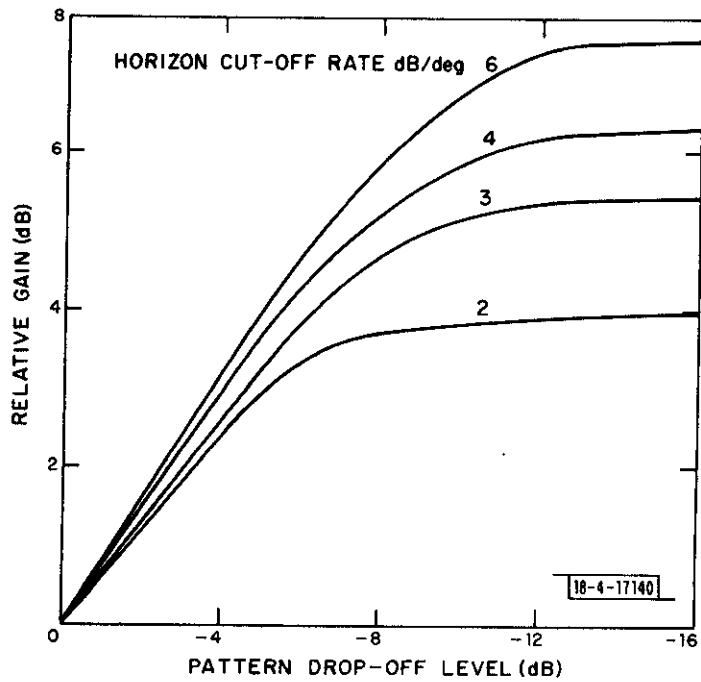

(c) Relative gain for 40° coverage.

Fig. 9. Continued.

3.1.5.1 Variation of Monopulse Slope With Elevation Angle

In a two-dimensional surveillance system, the target coordinates that are measured are slant range and bearing angle. The latter defines the vertical plane containing the target. The monopulse system to be used in DABS measures the bearing angle relative to the instantaneous antenna boresight direction. There is a natural tendency in almost all fan beam antennas to exhibit a decrease in the monopulse sensitivity with elevation angle by the factor, $\cos \alpha$, where $\alpha \equiv$ elevation angle. Although the total elevation angle dependence differs with various antennas, the above component is common to all because it is fundamentally related to the coordinate system in which the measurement is made. In a conventional beam splitting system, the effect manifests itself simply as a beamwidth broadening and does not cause an azimuth error in view of the fact that symmetry is preserved. In an off-boresight monopulse system, a change in the error signal is the equivalent effect; because the system is calibrated perfectly at only one elevation angle, errors will result for off-boresight targets. It must be remembered, however, that ultimately it is the associated cross-range error that is the significant parameter. Although the azimuth error will increase at higher elevation angles, the associated slant range reduction tends to keep the cross-range error within acceptable bounds. Typical numerical results for a target 2° off-boresight (a worst case example) are indicated in Fig. 10. Except for close-in targets above 10,000' (over-flights), the cross-range error is less than 100'. It appears that an elevation angle dependence of the monopulse error signal, comparable to the " $\cos \alpha$ dependence" of slope, is an acceptable behavior.

3.1.5.2 Sum-Difference Relative Phase

The preferred monopulse receiver, as specified in the DABS ER [Ref. 7] and implemented at DABSEF, is one in which the output is primarily sensitive to the bipolar amplitude of the Δ/Σ ratio, and secondarily sensitive to the phase between Σ and Δ . Any bias in this relative phase can be compensated by a length of transmission line. However, variation with an off-boresight angle (although taken into account in the calibration) results in an undesirable loss of sensitivity. Although this phase tends to be well behaved near boresight, it can be less so beyond the -3 dB points. Proper designs should limit the variation to a few degrees within the 3-dB beamwidth and to less than 10 electrical degrees out to the -10 dB points.

3.1.6 Miscellaneous

3.1.6.1 Hop-over

Hop-over is a feature that allows the beam to be "lifted" over low angle obstacles as the antenna scans across their azimuth, reducing the amplitude of the reflected signals and, thereby, the incidence of false targets.

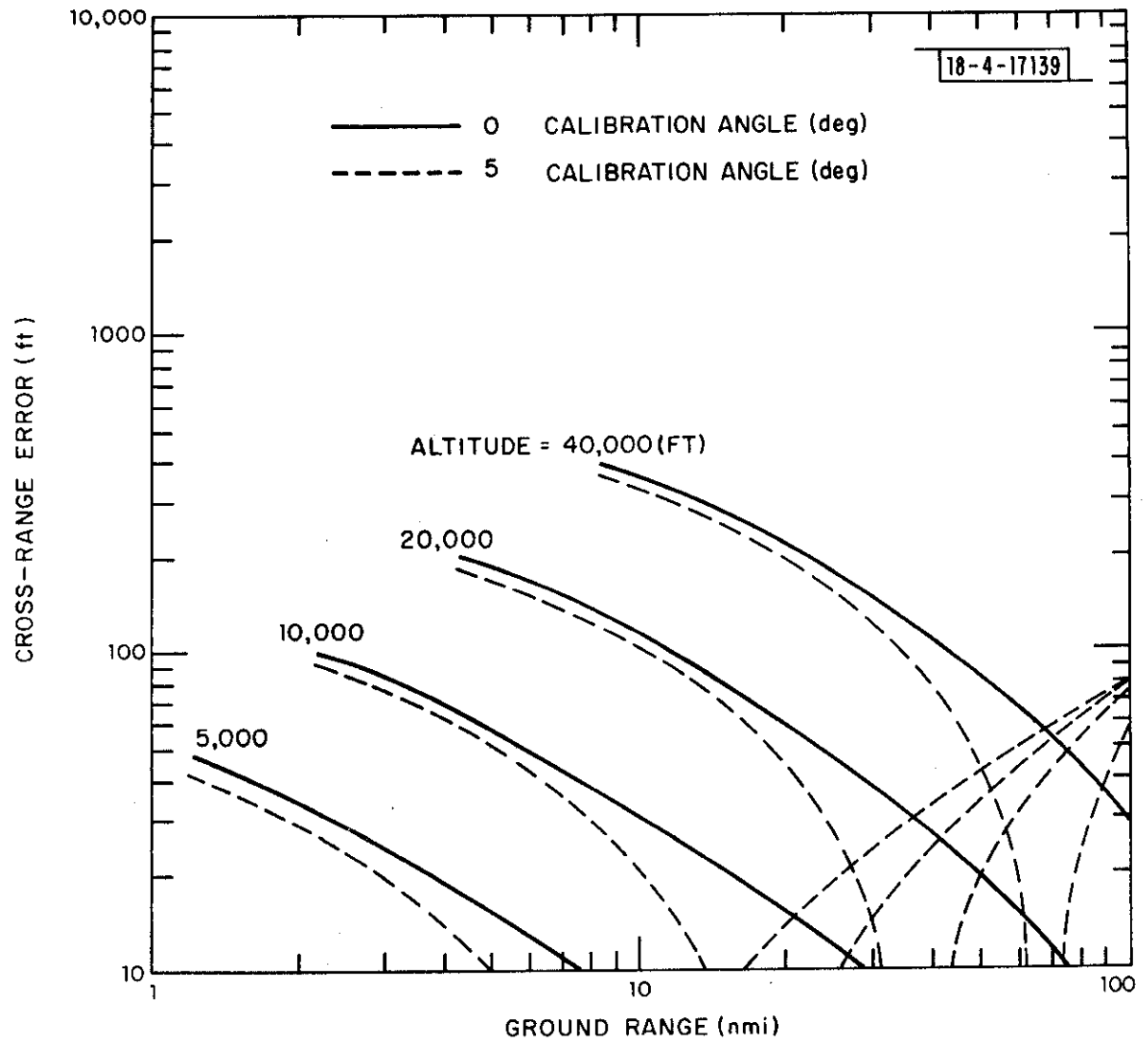

Fig. 10. Calibration induced cross-range error.

Hop-over was first implemented in the ATRBS E-scan antenna [Ref. 8]; its operational effectiveness has not yet been determined. The same type of techniques ("passive horn") has been successful for radar in reducing clutter at short ranges. However, as in the case of radar where new processing (MTD type) [Ref. 9] will reduce the value of this feature, it may very well be that the advanced DABS software will likewise do so. It is still probably worth keeping hopover in mind as an add-on feature to be implemented only if it can be clearly demonstrated to be cost effective.

3.1.6.2 Limited Azimuth Agility

Limited azimuth agility is the ability of the beam to be scanned about the mechanical boresight by an amount on the order of a beamwidth in order to increase the available angular dwell on a target. It could be used, for example, to obtain a more accurate update on a target azimuth by re-interrogation closer to the electrical boresight. It should be noted, however, that this does not help reduce the bias error, which is caused by the elevation angle dependence of the monopulse slope. Lincoln Laboratory studies do not indicate that this feature is actually needed, and there are strong indications that its use has a major impact on the initial antenna design and resulting cost.

3.2 Control Beam (Ω)

3.2.1 Functional Requirements

In a DABS sensor, the control pattern is used in transmission and reception; it must therefore be continuously available. In all transmissions, the control pattern is used by the transponder to suppress potential interrogations declared to come from the sidelobes. Although the details of the transponder operation are different in the ATRBS and DABS modes, the requirements on the control pattern are the same. Upon reception, it is used (by amplitude comparison with the Σ signal) to flag pulses coming from outside a predetermined monopulse acceptance angular window. Current planning for the ATRBS mode of DABS is to try not using "Improved SLS" so as to minimize suppressions that are needed. This means that the control beam need be effective only where the Σ sidelobes would elicit replies; this is different from ISLS, which attempts to guarantee suppression in the sidelobes (up to the range of effectiveness). In transmit and receive, the features of the control beam should be such that they would minimize false blanking of the mainbeam.

In all control functions, there is an additional parameter that can be used to optimize the operation; in transmission, it is the relative power, and in reception it is the threshold setting. Operationally, the control functions are dependent on the effective levels of Σ and Ω , i. e., the respective antenna pattern gains, weighted either by the optimized relative powers on transmission, or by the threshold on receive. In view of the fact that the high power mode of the transmission will occasionally be used to "burn through"

fades, it should be noted, however, that it is almost mandatory that the Ω to Σ power ratio should not exceed unity so as not to place any additional requirements on the transmitter.

3.2.2 Azimuth Characteristics

In most current ATRBS installations, the control antenna is stationary. Its azimuth pattern must, therefore, be essentially omnidirectional and is specifiable in terms of its peak-to-peak variation. In many respects, it is preferable that the control beam rotates along with the directional beam; the main penalty is the need for an extra channel in the rotary point. As far as sidelobe generated replies are concerned, the only necessary control pattern operation is to cover the Σ sidelobes. It is not even crucial to cover the Σ sidelobes perfectly at all angles because of the inherent frequency diversity of the transmit/receive process, which provides a two-level filtering process. Before a sidelobe reply can be falsely accepted, it must first pass the transmit SLS test at 1030 MHz and then pass the RSLs test at 1090 MHz; it is unlikely that a spurious sidelobe punch-through at one frequency would also occur at the other frequency. Fruit replies undergo only a one-way filtering on receive; however, the requirements for sidelobe fruit flagging tend to be less stringent than those of sidelobe reply suppression.

Beyond this qualitative discussion, it is difficult to derive a numerical criterion for the one-way sidelobe coverage by the control pattern. In the mainbeam azimuth sector, the control pattern should be of low level, thus preventing mainbeam suppression by as large a safety margin as possible. Because of the 9-dB threshold tolerance in the SLS action of the ATRBS transponders, the cross-over point with Σ should be no higher than the -12 dB point on the Σ pattern if the full 3-dB beamwidth is to be available for interrogation. The transition at the cross-over point should be as sharp as possible to minimize the range of azimuths over which the control action is uncertain.

While it appears desirable, as well as feasible, to achieve a 90% probability of successful sidelobe coverage, there is a rapidly decreasing value and increasing difficulty in achieving a 99% probability.

3.2.2 Elevation Characteristics

It is very desirable that the previously described azimuth characteristics be preserved at all elevation angles in the coverage sector. Therefore, two basic design trends for the elevation behavior of the control pattern should ideally be:

- (a) Free space elevation pattern identical to that of the Σ beam
- (b) Common phase center with Σ beam.

These features will guarantee that even with a bad in-plane lobing problem, the composite Σ and Ω beams will at least have an identical elevation behavior. Correspondingly, the azimuth sidelobe coverage requirements are not as stringent in view of the fact that less of a safety margin need be provided. Incorrect sidelobe control action can still occur if significant out-of-plane multipath is present. Good horizon cutoff for the control beam is particularly useful in reducing this problem because it is potentially more vulnerable than the Σ beam because it is less directional. This is another reason in favor of azimuth control pattern, which is as directional as can be while still covering the sidelobes.

In azimuth regions where the Σ beam elevation pattern and phase are somewhat erratic (back and far sidelobes), the control pattern (because it cannot be matched) should have sufficient cover margin. This is usually provided by an auxiliary radiator ("back fill") which, because it often does not have a suitable horizon cut-off rate, must in addition be such as to protect against its own lobing.

Note that as the horizon cut-off rate of the sum beam increases, the need for the control pattern and the sum beam to track (with respect to their elevation pattern) increases; although there is a decreasing need for their phase centers to coincide. This is significant when they are implemented by separate antennas. Also note that if the azimuth sidelobes of the directional beam change as a function of elevation angle, the control antenna must be tailored to maintain sidelobe coverage at all elevation angles.

4.0 ANTENNA HARDWARE IMPLEMENTATION

Being cognizant of the desirable characteristics previously described in this report, this section presents, in brief, some of the options available for implementing the antenna hardware. It is important at this point to examine (in the following subparagraphs) the options for each of the several possible associated primary radars.

4.1 Stand-Alone Beacon System

The case of a stand-alone beacon system is the simplest system to discuss because of the absence of any radar related constraints. There are four types of implementation that can be considered, each with its own unique features, as briefly outlined below:

- (a) Spoiled paraboloidal reflector with single focal feed. This reflector is the least expensive configuration, provided that the size is such that no radome is required. Its performance is restricted to elevation patterns no less directional than, for example, the ARSR-2; its integral control pattern is marginally acceptable.
- (b) Spoiled cylinder reflector with line source feed, as illustrated in Fig. 11. Slightly more expensive and with the same elevation pattern limitation as the previous configuration, this cylinder reflector has, however, a superior azimuth performance (comparable to that of an array) and, as such, appears to be a "better buy."
- (c) Unspoiled reflector with multiple stacked feeds (Fig. 12). This type of reflector is the least expensive way of obtaining both moderate cutoff (2 to 2.5 degrees) and constant gain, or high cutoff only (3 to 4 dB/degree). It has similar limitations in azimuth performance as the single-feed version.
- (d) Two-dimensional planar array (Fig. 13). This array combines all the best performance features at typically double the cost of the previously described implementations. In addition, it can present a serious field maintenance and service problem.

The addition of hop-over to the basic design presents a cost increment which is small in configurations (a) and (c) but is major in configurations (b) and (d). Further design details are provided in Ref. 1. Selecting one of the previous four types of implementations depends largely upon the amount of money one is willing to spend.

Of the four options previously described, the most cost effective appears to be the line-source-fed horizontal cylinder reflector. As a baseline design, it is suggested that the aperture be 25' wide and 12' high. This

18-4-17146

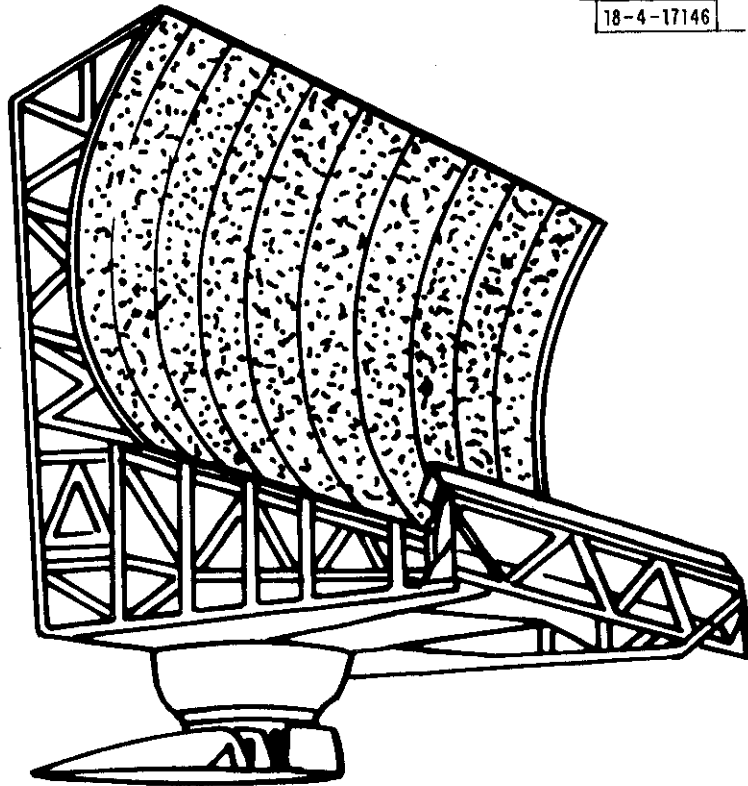

Fig. 11. Cylindrical reflector antenna.

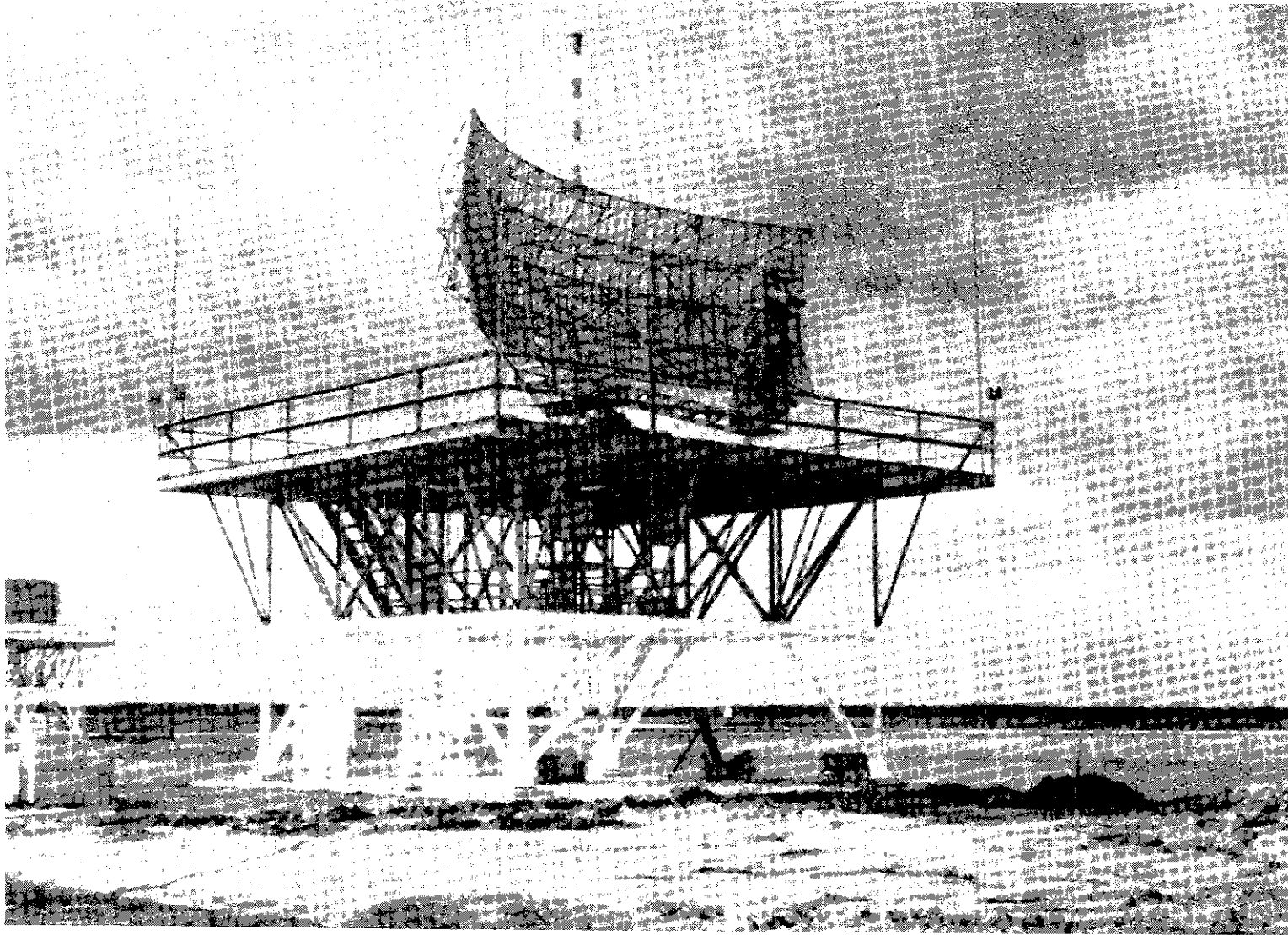

Fig. 12. Typical reflector antenna with stacked feeds and separate omni (after Texas Instruments).

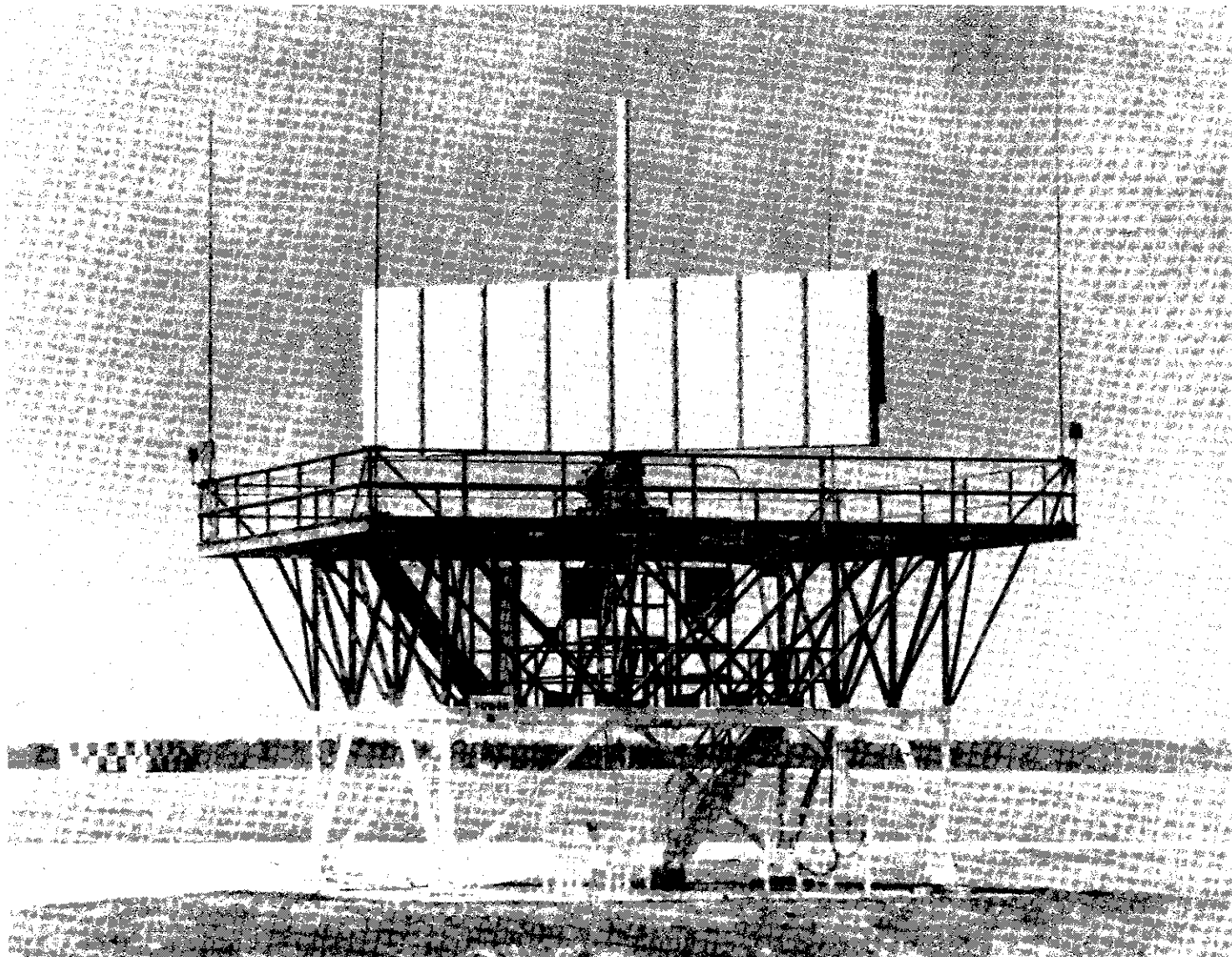

Fig. 13. Typical planar array with separate omni (after Westinghouse).

would provide a 2.5° beamwidth, and a 2-dB/degree cut-off rate for an elevation pattern that levels off no lower than -10 dB at upper angles. The line source feed would include a monopulse difference and integral control patterns, and would be very similar to the Cossor antenna. Using the feed array alone at sites could even be contemplated where cutoff is not required. The cost of such an antenna system, including the pedestal, drive, and triple-channel rotary joint, is estimated at less than \$100,000.

4.2 Retrofit on Existing ASR

The retrofit situation on the existing ASR is constrained by the existing reflector and pedestal. There are three antenna implementations currently available:

(1) A linear array, physically similar to the ATCRBS hogtrough (Fig. 14), but including a monopulse difference pattern and an integral control pattern. Although this type of array has not yet been produced with a low sidelobe difference pattern, it could easily be done. The main drawback of this antenna is its lack of control of the elevation pattern underside; it is therefore subject to lobing fades.

(2) A planar array with moderate aperture height (approximately 4 to 5 ft.) and standard 2.35° azimuth beamwidth, which, by special RF design techniques, is such that it would limit the wind loading to that of the present antenna (hence, the name "open array") as illustrated in Fig. 15. If the elevation cutoff rate is adequate for the site and if its behavior in a field environment is demonstrated to be stable, the performance is nearly optimum. Cost of the existing design is high (\$75,000 to \$100,000 for only the array).

(3) An integral beacon feed (Fig. 16) offers by far the least expensive means of adding monopulse capability and a moderate horizon cutoff to an existing ASR. It is constrained to an azimuth beamwidth of approximately 4° (the upper limit of acceptability) and to an elevation pattern with coverage similar to that of radar. The horizon cutoff is approximately 2 dB/degree, and the Σ and Δ patterns exhibit the desired low sidelobes. The integral control pattern is marginally acceptable. The high angle (above 20°) monopulse performance is also marginal.

In addition to the above configurations, a number of proposals have been made for new combined radar/beacon antennas constrained to be compatible with the existing pedestals. These would take advantage of the absence of the hogtrough in permitting a somewhat larger aperture than that of current reflectors. If it is correct to assume that the existing pedestals are being operated at or near the limit of their capability (subject to FAA 2100 environmental specifications), then the possible new antenna configurations do not have much to offer in comparison to those presently available. For example, a larger spoiled reflector with combined feed, i. e., $22' \times 10'$,



Fig. 14. ATCRBS hogtrough installed on ASR reflector.

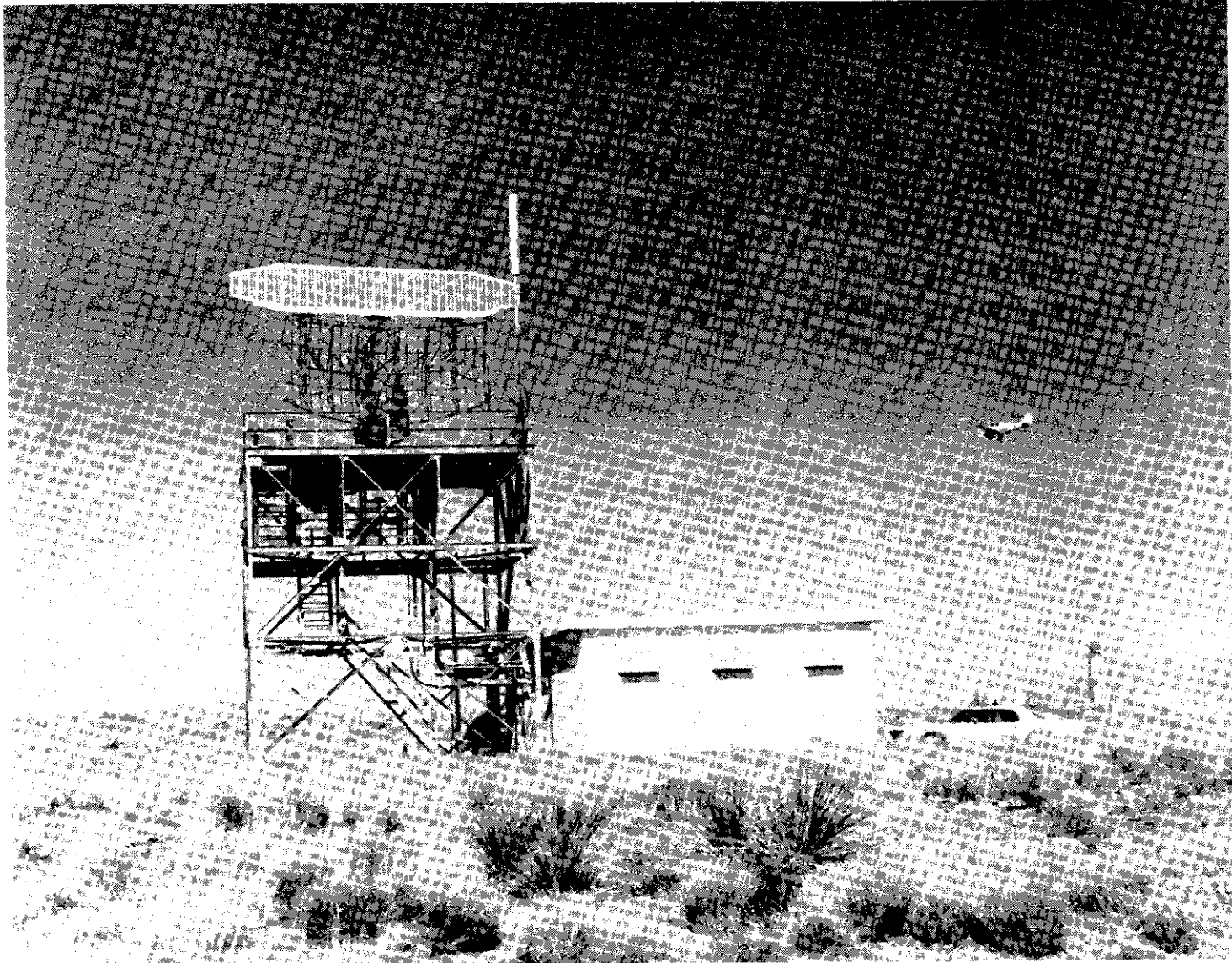

Fig. 15. Open array installed on ASR-7 reflector (after Hazeltine).

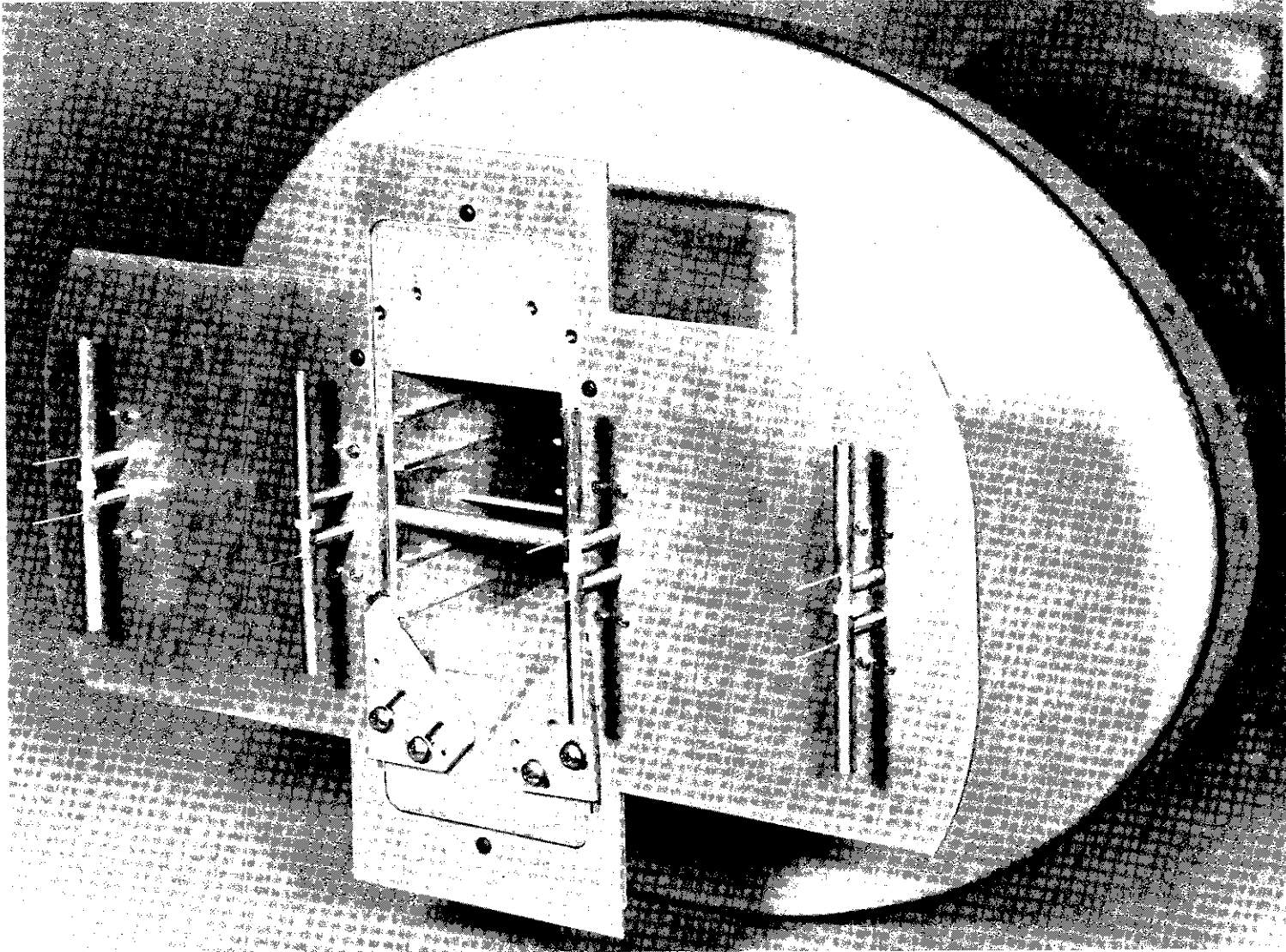

Fig. 16. Integral beacon feed for ASR-7; radome removed (after Texas Instruments).

could have an improved elevation coverage for beacon and radar; but the reduction in azimuth beamwidth, desirable for beacon, is undesirable for the radar MTI processing.

4.3 New Terminal Radar

4.3.1 S-band ASR

If additional ASR-8s are purchased beyond the present commitment or should there be a next generation of S-band terminal radars, a new complete antenna system different from the present system can be contemplated. The mechanical constraints previously adhered to would no longer exist, and additional possibilities can be considered.

If the radar is a conventional MTI system, then the least expensive combined antenna, configured to favor the beacon performance, is a spoiled reflector nominally 30' x 10', with combined focal feed. At L-band it features a 2.35° azimuth beamwidth, and an elevation pattern with a 2 dB/degree cutoff and a -10 dB "thumb" type high angle coverage. At S-band, the 0.9° azimuth beamwidth represents a 2-dB degradation in the subclutter visibility (SCV), relative to the current performance. Other configurations with more elaborate elevation features still have the same basic beamwidth problem.

If the radar is provided with an MTD-type coherent processor, then the S-band beamwidth must not be lower than approximately 1.7°; this implies an aperture width even smaller than the present width. Provided the radar beam is allowed to point closer to the ground than current practice, a vertically interlaced combined radar/beacon feed is then possible. Considering the large reflector width needed for beacon operation, the desired broad radar beamwidth is achieved by under illuminating the reflector with an oversized feed. For a spoiled reflector, only one feed to each frequency is needed (radar located on top). In an unspoiled reflector (if a higher cutoff is desired for the same aperture height), several multiple feeds, vertically stacked, are required (radar alternating with beacon).

4.3.2 L-band ASR

The recommendation of the ASR- () study group [Ref. 5] consisted of an L-band radar (1.25 GHz to 1.35 GHz) incorporating an MTD-type digital coherent processor and featuring a relatively low peak power. At L-band, it would not be necessary to use circular polarization to suppress weather clutter. With fixed horizontal polarization for radar and vertical polarization for beacon, it is possible to use this orthogonality to physically integrate the two structures, thereby realizing a combined radar/beacon antenna. Such an antenna (Fig. 17) would consist of a 28' - x 12' - unspoiled paraboloidal reflector with a 4' - x 12' - combined dipole array feed (vertical for beacon, horizontal for radar). The azimuth beamwidths are nearly optimum for each function (2.5° for beacon and 2° for radar). The elevation pattern would

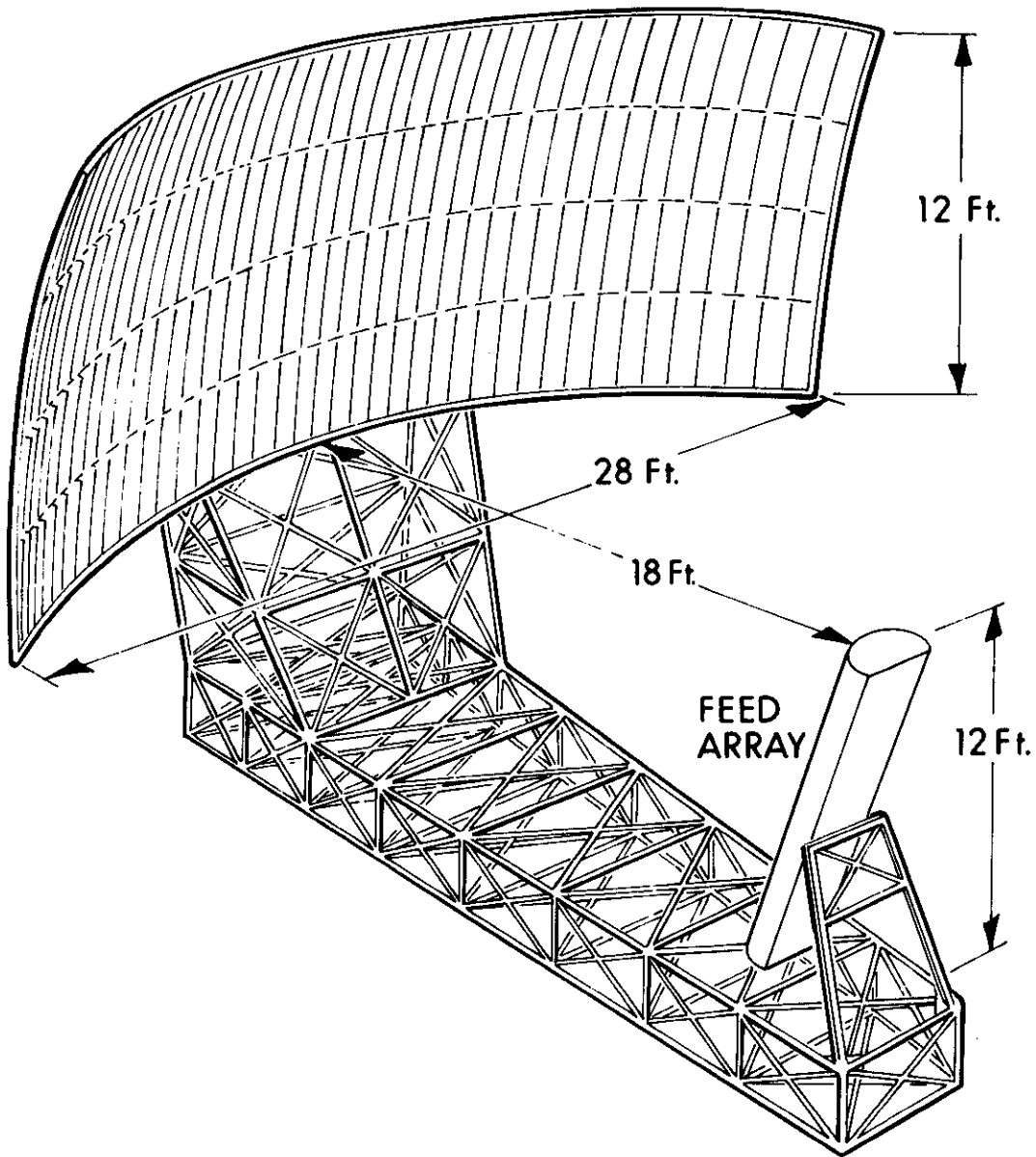

Fig. 17. Combined radar/beacon antenna for ASR.

have a 3.5 dB/degree horizon cutoff rate, and a 30° coverage sector shaped as desired; hopover could be included. The integral control pattern is implemented as proposed in other integral feed configurations. The combined antenna preserves the co-directionality between radar and beacon and permits direct target report correlation and reinforcement.

The original ASR-() study recommended a back-to-back antenna system in which the beacon antenna could be any of the several possible types discussed in the stand-alone systems (Section 4.1). From an implementation viewpoint, this has the advantage of allowing the independent development of the two systems and is of less risk. From a performance viewpoint, the system surveillance data rate is doubled (conceptually at least) at the expense of a more difficult correlation task.

4.4 Retrofit on Existing ARSR

For ARSR installations, two types of configurations are considered: (1) a single-beacon antenna configuration, which is co-directional with radar providing a 12-second data rate, and (2) a configuration with two "back-to-back" antennas providing a 6-second data rate. The second configuration is motivated by IPC requirements.

4.4.1 Twelve-Second Data Rate

4.4.1.1 Replacement Antenna

The replacement antennas that can be contemplated are a linear array with expanded capability (Σ , Δ ; Ω) or a moderate height planar array. The linear array would still be top-mounted, although, in an ARSR-2 installation, the proximity of the radome is a cause for concern; because of its lack of a horizon cutoff feature, it may be unsuitable for locations with lobing problems or sloping terrain. For an ARSR-2 site, a 4' to 5' tall planar array can be supported from the radar feed boom. Depending on the mechanical constraints, the array may be of either the conventional or "open" types. In an ARSR-3 site, although there may not be sufficient platform clearance for a chin mounting, there is space on top of the reflector for such an array because of the larger planned radome and the platform-recessed pedestal.

4.4.1.2 Integral Beacon Feed

En-route radars operate at a frequency between 1.25 GHz and 1.35 GHz, and their polarization is capable of being switched from vertical to circular. The combination of these two facts has the following consequences:

(a) Vertically polarized beacon radiating elements cannot be located inside the radar horn or in its aperture without seriously affecting its polarization properties.

(b) If located outside the horn aperture, the elements result in a performance less than desirable because the most natural location of the beacon feed coincides with that of radar as a result of the closeness of the frequency bands. (There are special circumstances in which the resulting performance may still be acceptable in view of the alternatives available.)

The preceding comments relate to attempts at providing DABS capability as an add-on to an existing radar horn; they do not necessarily apply to a new integrated feed design. Certainly, if radar operation with only horizontal polarization is acceptable, such a design is much more feasible. It may be contemplated even under the present polarization requirements, e.g., as a wideband dual-polarized horn with separate frequency diplexed inputs for radar and beacon. The feasibility of such an approach, or other proposals, can ultimately be determined by only a dedicated development program with allowance for multiple iterations.

4.4.2 Six-Second Data Rate

If a back-to-back system is to provide reliable doubling of the data rate in support of IPC, both beacon antenna faces should be very similar; this would eliminate an integral beacon feed from consideration as one of the faces. At an ARSR-2 site (radome), the options are a pair of top mounted and back mounted planar arrays compatible with the existing physical constraints. At an ARSR-3 site, with a larger radome, either of those two basic sets of antennas can be top mounted. At an ARSR-1 (or other non-radome) site, back-to-back linear arrays appear at least mechanically acceptable; although the "openness" of back-to-back open arrays warrant verification. According to present plans, such a two-face antenna system would be utilized on a time-shared basis by a single DABS sensor by switching from one to the other. By locating the switch on the rotating side of the rotary point, only 3 channels need be piped through; this is preferable to switching on the stationary side of the rotary point which requires 6 beacon channels (in addition to at least one for radar).

5.0 SITE CONSIDERATIONS

5.1 Characterization of Sites

The physical environment in which beacon systems are located is quite varied, not only from site to site but even at a given location, from one azimuth to another. The usual features at terminal sites are flat terrain (soil or water) at many azimuths in the vicinity of the antenna, and a built-up skyline within a few miles. The effect of both of these features tends to be accentuated by the relatively low tolerable radar tower heights. At en-route sites, the higher tower heights help reduce shadowing by nearby obstacles, with the result that more distant terrain, including rolling hills with tilted surfaces, can be seen often.

5.2 Site Effects

Currently, the most common site effects are:

(a) In-plane lobing fades caused by specular reflections from flat terrain for which there is considerable theoretical and experimental background information.

(b) Reflections from tilted terrain generating out-of-beam interrogations and, consequently, false targets usually a few degrees away from the real target.

(c) Reflections from man-made structures causing false targets to appear at azimuths that tend to be radically different from those of the real target. These reflections have been observed outside and inside the theoretical range of effectiveness of Improved Sidelobe Suppression.

(d) Diffraction and shadowing from similar structure [Ref. 10].

Man-made obstacles, principally urban skylines, represent a problem over which little, if any, control can be exercised. In view of the fact that terminal radar/beacon systems are generally located on the airport surface, there is not enough freedom in siting the antenna to have much of an impact on the effect of such obstacles except for airport structures. The nature of the resulting fades and direction-finding errors is such that narrow azimuth beamwidths are generally favored for reducing both problems, and high gain, in general, helps the fade situation. False targets, which are generated by built-up areas, tend to appear in a fixed predictable pattern which, after a period of time is devoted to a learning process, can be recognized and edited by the DABS sensor software.

At certain sites or directions that do not have lobing-producing flat terrain, fades remain at low elevation angles by multiple scattering and/or shadowing by the hilly terrain. Theoretical results, corroborated by experimental results at DABSEF, indicate that this is relatively unaffected by the

horizon cutoff rate [Ref. 11]. However, high absolute gain is one way by which the antenna can lessen the impact of this phenomenon. It appears, therefore, that in any case, a desirable beacon antenna is one which has sufficient vertical aperture (real or effective) to provide both high gain and moderate horizon cutoff.

5.3 On-site Optimization

Except for the selection of the antenna itself, the only parameters available in principle for on-site optimization of the antenna system are the height above ground and the elevation tilt angle.

Several analyses performed at Lincoln Laboratory indicate that, from a performance viewpoint, the beacon antenna should be located as high above ground as practical. This helps reduce the effects of nearby obstacles and, at many sites, prevents the formation of low-angle deep lobing fades. This trend is compatible with a similar one for MTD equipped radars. However, it is also recognized that the height above ground may often be predetermined by operational constraints of an existing site or by the occasional difficulty in finding suitable locations for calibration transponders. Tilt adjustments seem to be much more feasible, although this is strongly influenced by the nature of the site. For a stand-alone beacon site and for an antenna system with constant tilt vs rotation, the optimum tilt will be a compromise between two opposing factors: low illumination of the terrain and obstacles, and high net gain at low elevation angles. Based on lobing considerations alone and using the absolute gain value at the fade minima as a performance criterion, the optimum tilt tends to lie over a broad range. As a nominal criterion, locating the horizon between the -3 dB and the -8 dB points is satisfactory in most cases; if the horizon is located above the -3 dB point, the benefits of cutoff rapidly disappear. If the horizon is located below the -8 dB point, the pattern shape, pointing accuracy and terrain variations become too critical for benefits to be reliably achieved. These conclusions are based on the evaluation of the measured pattern characteristics of several beacon antennas. Figure 18 illustrates the measured pattern characteristics for the DABSEF array. It may be concluded from the foregoing results that when there are blocking or diffraction fades in addition to lobing fades at sites, the horizon should be located further up than the -6 dB point, e.g., the -3 dB, so as to benefit from the absolute gain advantage while not significantly causing the lobing fades to become worse.

At joint radar/beacon sites, the tilt of the radar antenna is usually optimized on site as part of the commissioning process. For beacon antennas that are electrically independent of radar, i.e., "open-array," their tilt can be adjusted mechanically, following the same criterion as in a stand-alone system. For beacon antennas that are electrically dependent on the associated radar antenna, i.e., integral or combined feeds, the situation is potentially more complicated in view of the fact that the radar tilt varies from site to site. Two possibilities arise: the beacon feed is designed in a manner that the relative pointing of the two antennas either can or cannot be

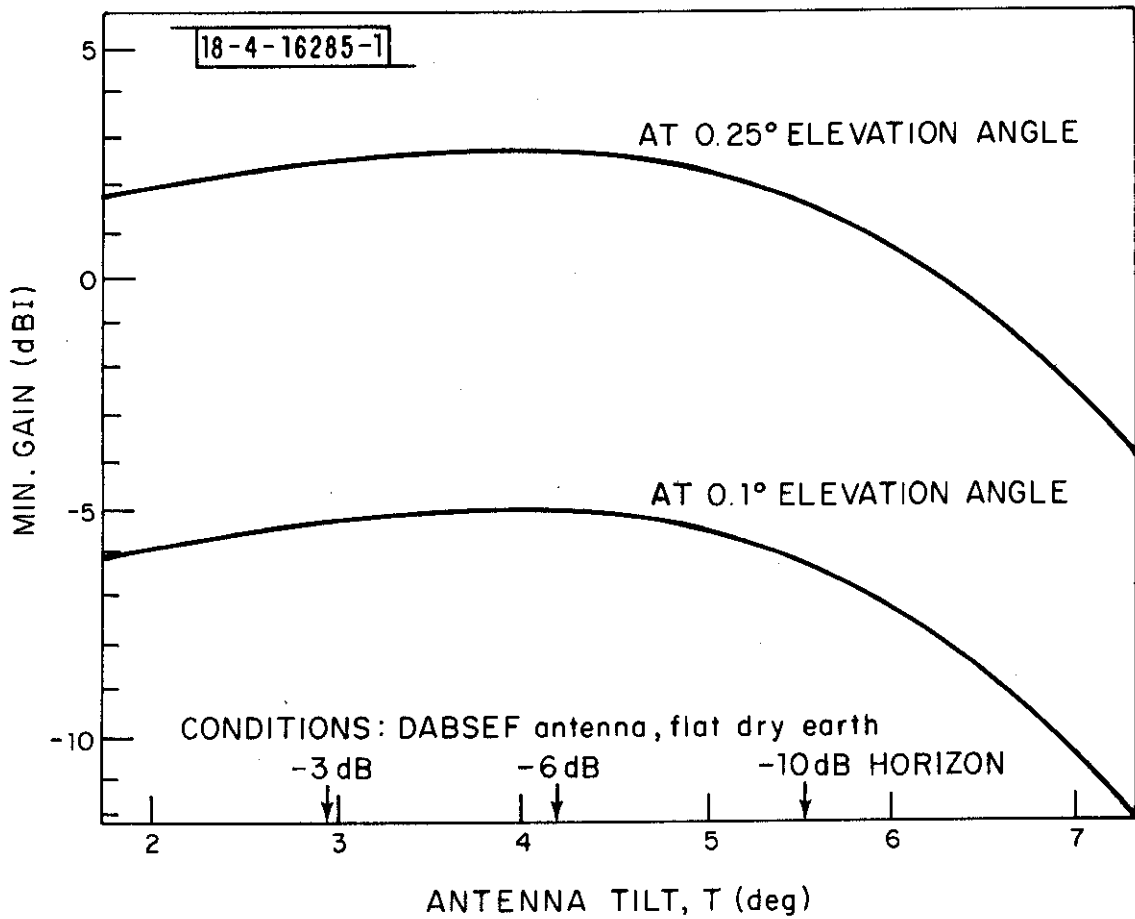

Fig. 18. Influence of antenna tilt on low-angle lobing minima.

tailored to the site. In either case, there are advantages and disadvantages. The principle advantage of a variable relative offset is that radar and beacon can then be independently tilted. However, since the beacon optimum is a rather broad one, the beacon beam pointing relative to radar can be fixed in a manner that over a reasonable range of radar beam tilts, the resulting beacon beam tilt (relative to the horizon) is acceptable. This would simplify the deployment process, avoid keeping extensive individual design records, make the antennas readily interchangeable, and avoid the possibility of what could be a costly error in designing for the wrong tilt.

As a further consideration in selecting the tilt angle, the calibration transponders should be located in a manner that the monopulse calibration thus generated is in fact representative of operational elevation angles. The trend would, therefore, be toward lower tilt angles, thereby providing means for calibration near the peak of the beam. The lower limit of acceptability for the calibration angle should be determined by actual measurements of the monopulse characteristics of the particular type of antenna of interest on a test range. However, the calibration issue remains somewhat open and ultimately may not impact the antenna siting.

6.0 ON-SITE MEASUREMENTS

There are still many issues that remain quantitatively unresolved. Although modeling and simulations can point to desirable trends, many of these issues are critically dependent on the real world environment, with which actual engineering solutions must ultimately contend. It is hoped that the two measurements facilities being assembled by Lincoln Laboratory, the Airborne Measurement Facility (AMF) and the Transportable Measurements Facility (TMF), can be helpful in providing the needed data.

The AMF is used to record transmitted signals from any site (hence any antenna) and can be helpful in directly evaluating (for example) the fades experienced over different types of terrain.

The TMF interrogates either targets of opportunity or test aircraft, and records video pulse characteristics of the replies. Presently either of two interrogator antennas is scheduled to be used: (1) a linear array with a monopulse and integral suppression capability (Cossor), and/or (2) an ASR-7 reflector with integral beacon feed and top-mounted matched omni (Texas Instruments). The antennas have significantly different characteristics; however, together they include essentially all the desirable features discussed previously. A direct comparison of signals, as received by the two interrogator antennas and following test procedures designed to highlight similarities or differences, should provide a valuable input to the selection of antennas for various sites.

REFERENCES

- [1] J. C. Sureau, "Summary of Results of Antenna Design Cost Studies," Project Report ATC-22, FAA-RD-74-20, Lincoln Laboratory, M.I.T., (19 February 1974).
- [2] Quarterly Technical Summary, "Development of a Discrete Address Beacon System," Lincoln Laboratory, M.I.T. (1 July 1973), Sec. VI, FAA-RD-73-101, DDC AD-766601/9.
- [3] Op. cit. (1 October 1974), Sec. IV, FAA-RD-74-167.
- [4] Op. cit. (1 July 1974), pp. 29-39, FAA-RD-75-114.
- [5] J. C. Sureau, "ASR-() DABS Back-up Radar Development Plan," private communication.
- [6] D. K. Barton and H. R. Ward, Handbook of Radar Measurement (Prentice-Hall, New Jersey, 1969), Appendix A.
- [7] "FAA Engineering Requirement, Discrete Address Beacon System (DABS) Sensor," FAA-ER-240-26.
- [8] R. J. Giannini, et al., "A New Cylindrical Electronic-Scan Antenna for Air Traffic Control," IEEE International Conv. Digest (March 1972).
- [9] W. H. Drury, "Improved MTI Radar Signal Processor," Project Report ATC-39, RAA-RD-74-185, Lincoln Laboratory, M.I.T. (3 April 1975).
- [10] A. Spiridon, "Impact of Obstacle Shadows on Monopulse Azimuth Estimate," Project Report ATC-50, FAA-RD-75-91, Lincoln Laboratory, M.I.T. (21 May 1975).
- [11] A. Spiridon, "Effects of Local Terrain and Obstacles Upon Near Horizon Gain of L-Band Beacon Antennas," Technical Note 1975-6, Lincoln Laboratory, M.I.T. (17 July 1975).