

**Project Report  
ATC-174**

# **Automated Flight Strip Management System Functional Description**

**S. D. Thompson**

**19 November 1990**

---

**Lincoln Laboratory**

MASSACHUSETTS INSTITUTE OF TECHNOLOGY  
*LEXINGTON, MASSACHUSETTS*

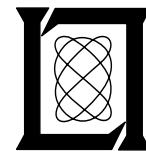

Prepared for the Federal Aviation Administration,  
Washington, D.C. 20591

This document is available to the public through  
the National Technical Information Service,  
Springfield, VA 22161

This document is disseminated under the sponsorship of the Department of Transportation in the interest of information exchange. The United States Government assumes no liability for its contents or use thereof.

1. Report No. ATC-174	2. Government Accession No. DOT/FAA/ARD-90/27	3. Recipient's Catalog No.	
4. Title and Subtitle Automated Flight Strip Management System Functional Description		5. Report Date 19 November 1990	
		6. Performing Organization Code	
7. Author(s) Steven D. Thompson		8. Performing Organization Report No. ATC-174	
9. Performing Organization Name and Address Lincoln Laboratory, MIT P.O. Box 73 Lexington, MA 02173-9108		10. Work Unit No. (TRAVIS)	
		11. Contract or Grant No. DTFA-01-89-Z02039	
12. Sponsoring Agency Name and Address Department of Transportation Federal Aviation Administration Systems Research and Development Service Washington, DC 20591		13. Type of Report and Period Covered Project Report	
		14. Sponsoring Agency Code	
15. Supplementary Notes  This report is based on studies performed at Lincoln Laboratory, a center for research operated by Massachusetts Institute of Technology under Air Force Contract F19628-90-C-0002			
16. Abstract  <p style="text-align: center;">This document gives a high level functional overview of an automated flight strip management system. The current manual flight strip system at Boston's Logan Airport is reviewed and described in detail for both the Tower Cab and TRACON with emphasis on the information flow as an aircraft progresses through the system. The interfaces between the ATC elements, as they relate to flight data, are explained. Finally, the system requirements are described including specific requirements for Tower Cab positions.</p>			
17. Key Words  flight progress strips air traffic control automation		18. Distribution Statement  Document is available to the public through the National Technical Information Service, Springfield, VA 22161.	
19. Security Classif. (of this report)  Unclassified	20. Security Classif. (of this page)  Unclassified	21. No. of Pages  50	22. Price

## **ACKNOWLEDGMENT**

The author would like to acknowledge the assistance of the staff of the Boston Tower in the preparation of this report. In addition, concepts for the Automated Strip Management System are largely based on ideas originated by Boston Tower personnel.

## TABLE OF CONTENTS

Acknowledgement	iii
List of Illustrations	vii
List of Tables	vii
1. INTRODUCTION	1
2. PROGRAM DESCRIPTION	3
3. FUNCTIONAL OVERVIEW	5
3.1 Flight Plan Data Base	5
3.2 Interfaces	5
3.3 Human Factors	5
3.4 Operational Recording and Eligibility Functions	6
3.5 Traffic Data	6
3.6 Archiving and Retrieval	6
3.7 Hardware	6
4. CURRENT BOSTON FLIGHT STRIP SYSTEM	7
4.1 Flight Plans in the ATC System	7
4.2 Flight Progress Strip Description	10
4.3 Use of Flight Progress Strips at Boston	16
4.3.1 Use of Flight Progress Strips in the Logan Tower Cab	16
4.3.2 Use of Flight Progress Strips in Boston TRACON	16
4.4 Flight Stages and the Processing of Flight Progress Strips	18
4.4.1 Departing	18
4.4.1.1 Aircraft at Gate without Clearance	18
4.4.1.2 Clearance Delivery	21
4.4.1.3 Boston "Gate"	22
4.4.1.4 Taxiing	23
4.4.1.5 Take-Off	23
4.4.1.6 Handoff to TRACON	24
4.4.2 Arriving	24
4.4.2.1 In Boston TRACON airspace	24
4.4.2.2 Local Handoff	24
4.4.2.3 Ground Control Handoff	26
4.4.2.4 Out-of-Movement Area	26
5. SYSTEM REQUIREMENTS	27
5.1 Hardware and Interface Requirements	27
5.2. Screen Design Requirements	30
5.2.1 Supervisor	30
5.2.2 Flight Data	31
5.2.3 Clearance Delivery	33

## TABLE OF CONTENTS (Continued)

5.2.4 Boston Gate	33
5.2.5 Ground Control	36
5.2.6 Local Control (Tower)	38
5.2.7 Helicopter/TCA	38
5.2.8 TRACON	38
5.3 Human Factors Requirements	38
5.4 Data Base Requirements	40
5.4.1 Archival and Retrieval Requirements	40
5.4.2 Traffic Data Recording Requirements	41
5.4.3 Operational Recording and Eligibility Requirements	41
5.5 Optimum Queue Module	41

## LIST OF ILLUSTRATIONS

Figure No.		Page
1	FAA Flight Plan Form	6
2	ATC Flight Plan Flow	7
3	Illustration of Terminal Flight Progress Strip	9
4	Use of Flight Progress Strips in Boston Logan Airport	15
5	Figure Progress Strip Flow for Departure Aircraft at Boston Logan Airport	17
6	Flight Progress Strip Flow for Arrival Aircraft at Boston Logan Airport	23
7	Current Interfaces for Flight Data Information Flow for Flights into or out of Boston	26
8	ASMS Interface Requirements	27
9a	ASMS Flight Data Screen	30
9b	ASMS Clearance Delivery Screen	32
9c	ASMS Boston Gate Screen	33
9d	ASMS Ground Control Screen	35
9e	ASMS Local/ TRACON Screen	37

## LIST OF TABLES

Table No.		Page
1	Terminal Flight Progress Strip Data	10
2	Aircraft Equipment Suffix in Data Blocks 3	11
3	Flight Progress Strip Clearance Abbreviations	12
4	Flight Progress Strip Miscellaneous Abbreviations	13

## 1. INTRODUCTION

The purpose of this document is to provide a functional description of the Automated Strip Management System (ASMS). ASMS is designed to be an improvement over the current manual system of paper flight data strips, plastic holders, metal racks and felt-tip markers now employed in the Tower Cabs and TRACONS at major airports. The objectives for ASMS include improved coordination between controllers, a reduction of controller workload, and the automation of most manual record keeping procedures. ASMS will provide position-specific information to the controller when he or she needs it in a manner that displays the data in the most useable form for the controller to accomplish his or her job. ASMS will provide a better interface with controllers for data entry and transfer than exists with the present manual system, reducing the chance for errors and increasing productivity. Additionally, ASMS is intended to provide the Traffic Management Unit (TMU) in the Air Route Traffic Control Center (ARTCC) real time ground information suitable for traffic management, reducing or eliminating the requirement for voice communications.

In addition to the objectives listed above, the implementation of ASMS at Logan Tower will remedy a deficiency in the existing system for passing Flight Progress Strip data for departing aircraft from the Tower Cab to the TRACON located in an adjacent building. The present method employs a video camera in the cab pointed down at the rack of Flight Progress Strips at the Local Control position and two TV monitors in the TRACON. As a result of reflections, variations in tower light levels, and low TV resolution, this system has been judged to be inadequate. Although solving an immediate and serious problem specific to Boston's Logan Tower, ASMS will be designed for use at any major tower replacing other means of flight data communications currently employed in the ATC system including voice and drop tubes.

This document first describes the ASMS program and gives a high level functional overview. Next, the current flight strip system at Boston Logan is reviewed and described for both the Tower Cab and TRACON with emphasis on the information recorded and needed as the flight strip progresses through the system. This includes a description of the aircraft stages (or states) during the departure and arrival process in terms of information known at each stage (by controller and aircraft) and possible transfers to succeeding stages or states. Finally, the system requirements are described in detail including specific requirements for each controller position. The main technical challenge for ASMS will be the development of controller interfaces that provide an operationally suitable system in the Tower cab environment. For this reason, the human factors functions and requirements have been separated from the "information" functions and requirements in this document. The prototype system will be designed to allow changes in the controller/ASMS interface as operational experience is gained.



## 2. PROGRAM DESCRIPTION

ASMS, which automates the handling of flight strip data, represents a portion of the automation technology now under consideration or planned for the Tower Cab. The concept is to design ASMS as a stand-alone system that will bring immediate improvements to Boston's Logan Tower and be flexible enough for incorporation into other major towers but to recognize that ASMS must be designed so that it can be integrated into other automation programs. Specifically, as part of the NAS Plan Upgrade, the concept is to integrate ASMS into the Airport Surface Traffic Automation (ASTA) system and, eventually, into the Tower Cab Computer Complex (TCCC).

The *purpose* of the Automated Flight Strip Management System (ASMS) is to provide electronic flight plan handling software and hardware to Boston's Logan Tower. A *benefit* of the Program will be to provide a test bed for developing operational concepts in flight plan management for the upcoming Tower Cab Computer Complex (TCCC) Project. The ASMS Program will also share a portion of the data base, software, and hardware that will be needed by the Airport Surface Automation (ASTA) Program. ASTA is an FAA program for the development and application of advanced surveillance, communications and automation technologies to the control of aircraft and other vehicles on the airport surface with the objectives of improving safety, reducing delays, increasing capacity, and enhancing productivity. Initial elements of the ASTA Program will be available for evaluation as early as 1992 with the installation of the new ASDE-3 radar. The Terminal Air Traffic Control Automation (TATCA) Program is also scheduled for initial evaluation at Boston Logan starting in 1992. ASMS will provide critical data to this program as well.

### **3. FUNCTIONAL OVERVIEW**

The Automated Flight Strip Management System is designed to provide the following functions:

#### **3.1 FLIGHT PLAN DATA BASE**

The ASMS will maintain a current Data Base of all flight plans and amendments for flights arriving in, departing from, or overflying the Boston TRACON airspace. These will include flight plans from the Boston Air Route Traffic Control Center (ARTCC) Host computer which comprise flight plans filed through Automated Flight Service Stations (AFSSs) and airline "canned" flight plans, and locally derived flight plans and amendments including VFR Terminal Control Area (TCA) arrivals and departures.

#### **3.2 INTERFACES**

ASMS will be designed to share the interfaces being developed for the Terminal Air Traffic Control Automation (TATCA) Program that tap data from the Host and Automatic Radar Terminal System (ARTS) computers. The interface with the Host will be at the Peripheral Adapter Module (PAM) in the Boston ARTCC and will have access to messages being sent to the Logan Flight Data Input/Output (FDIO) ports in the Tower and TRACON. The ARTS interface will be at the maintenance display terminal in the TRACON and will provides real time information on aircraft (identification, beacon code, type, speed, altitude, destination, controlling position, and location) for airplanes being tracked by the TRACON radar. This will include data on aircraft without flight plans that has been entered directly into the ARTS computer by a controller. The ARTS real time data is of interest primarily for arriving aircraft to determine landing sequence and runway assignment. The FDIO ports have access through the Host to flight plans for arriving, departing, and overflight aircraft as well as General Information (GI) messages. The GI messages include Center Weather Advisories (CWAS) such as Significant Meteorological Information (SIGMETS), Airman's Meteorological Information (AIRMETS), and terminal forecasts, and Traffic Management Unit (TMU) advisories such as daily restrictions on traffic flow to specific airports.

The ASMS will be designed to accommodate interfaces with additional airport equipment and status displays including the Airport Information Distribution System (AIDS), the Low Level Wind Shear Alert System (LLWAS), Automatic Weather Observing System (AWOS), Automatic Terminal Information System (ATIS), Systems Atlanta Information Display (SAIDS) computer, Digital Alimentary Setting Indicator (DASI), airport configuration input, runway visual range (RVR) measuring equipment, runway lighting status, and the computer generated airport users interface line which provides general information between the airport operator and user, etc.

#### **3.3 HUMAN FACTORS**

The ASMS will provide human factors engineered protocols and entry devices to allow for simple single action entry of next logical functions and to minimize the need to interrupt viewing outside the Tower cab. The system will provide CRT display images and interfaces customized to the individual controller positions. Effective interfacing with controllers requires that only the flight data needed by the position be displayed.

### **3.4 OPERATIONAL RECORDING AND ELIGIBILITY FUNCTIONS**

The ASMS will provide for a method of recording the time that individual controllers spend at each position and automate the controller eligibility checking for each position. It will also provide a record of controller training at a position.

### **3.5 TRAFFIC DATA**

The ASMS will provide a means for recording traffic data including Traffic Count, Delay Reporting Data, runway usage and airport configuration, missed approaches, and delay times by examining real time data. The system will provide for standardized reports.

### **3.6 ARCHIVING AND RETRIEVAL**

The ASMS will provide for a system of archiving and retrieving of all data for a specified length of time. Long term storage will be provided by off-line devices but the ASMS will have the capability of reading data stored off-line. This will include the ability to retrieve or recreate displays that were presented to controllers at specified times and inputs by controllers. The most likely system will employ a removable hard disk system for economical long term storage and quick access.

### **3.7 HARDWARE**

The ASMS will provide human engineered CRT terminal screens for each controller position interconnected with a local area network within the Tower cab and include intrafacility communications connections with the TRACON. The CRT screens must be readily visible in high ambient lighting conditions. Specifications for Tower Cab CRTs under the TCCC contract cannot be met with current color display technology.

## **4. CURRENT BOSTON FLIGHT STRIP SYSTEM**

This section describes the current flight strip system at Boston's Logan Airport. First is a general discussion of how flight plans are entered into the Air Traffic Control (ATC) system and how and where the resulting Flight Progress Strips are generated. Next, the physical handling and processing of the strips is described for the Boston Tower Cab and the TRACON environments. Next is a description of the Flight Progress Strip itself and the data contained on the strip. Finally, the progress of a strip is followed in relation to the progress of an aircraft through the various stages of departure and arrival with emphasis on the information available to and input by the various controller positions. This will set the stage for specifying an automated system ensuring that the correct information is available to the needed controller position at the right time.

### **4.1 FLIGHT PLANS IN THE ATC SYSTEM**

Flight plans for flights conducted under Instrument Flight Rules (IFR) or Visual Flight Rules (VFR) are nominally entered into the Air Traffic Control (ATC) system through Automated Flight Service Stations (AFSS). The pilot calls or visits the AFSS, receives a weather briefing, and files a flight plan with the specialist. A flight plan form is used by the pilots and AFSS specialists to record the information and is reproduced in Figure 1.

For flights that are conducted repeatedly, such as scheduled airline flights, the flight plan data can be stored on computer tape for automatic entry into the system. Computer tapes for airline flight plans are kept at Air Route Traffic Control Centers (ARTCC) and entered directly into the Host computer. The AFSSs also have the capability of storing flight plans on computer tape and this is often done for standard flight plans used, for example, by air taxis. Flight plans for all IFR flights and any VFR flights that request services from ATC, such as traffic advisories, are entered into the Host computer at the ARTCC serving the departure airport. The system of Host computer determines what ARTCCs will be controlling the flight and will transmit the flight plan data to the succeeding controlling ARTCC as the flight progresses. These Host computer generates Flight Progress Strips through Flight Data Input/Output (FDIO) printers at controlling facilities. Controllers can also use the FDIO to manually input flight plans. VFR flights not requesting services are not entered into the Host computer. The flight plan process is illustrated in Figure 2.

Any flight plan filed at any AFSS or entered from computer tape or manually at any Center that enters into the system of Host computers, as described above, for a flight that will depart, arrive or fly through airspace controlled by Boston Center, will be transferred to the Host computer at Boston ARTCC in Nashua, New Hampshire. The Host computer at Nashua will determine which of these flights will use airspace controlled by Boston TRACON. The airspace controlled by Boston TRACON is defined in a letter of agreement between Boston TRACON and Boston Center and generally includes airspace within

U.S. DEPARTMENT OF TRANSPORTATION FEDERAL AVIATION ADMINISTRATION		<b>(FAA USE ONLY)</b> <input type="checkbox"/> PILOT BRIEFING <input type="checkbox"/> VNR <input type="checkbox"/> STOPOVER			TIME STARTED	SPECIALIST INITIALS	
<b>FLIGHT PLAN</b>							
1. TYPE	2. AIRCRAFT IDENTIFICATION	3. AIRCRAFT TYPE/ SPECIAL EQUIPMENT	4. TRUE AIRSPEED  KTS	5. DEPARTURE POINT	6. DEPARTURE TIME		7. CRUISING ALTITUDE
VFR					PROPOSED (Z)	ACTUAL (Z)	
IFR							
DVFR							
8. ROUTE OF FLIGHT							
9. DESTINATION (Name of airport and city)		10. EST. TIME ENROUTE		11. REMARKS			
		HOURS	MINUTES				
12. FUEL ON BOARD		13. ALTERNATE AIRPORT(S)		14. PILOT'S NAME, ADDRESS & TELEPHONE NUMBER & AIRCRAFT HOME BASE		15. NUMBER ABOARD	
HOURS	MINUTES						
				17. DESTINATION CONTACT/TELEPHONE (OPTIONAL)			
16. COLOR OF AIRCRAFT		CIVIL AIRCRAFT PILOTS. FAR Part 91 requires you file an IFR flight plan to operate under instrument flight rules in controlled airspace. Failure to file could result in a civil penalty not to exceed \$1,000 for each violation (Section 901 of the Federal Aviation Act of 1958, as amended). Filing of a VFR flight plan is recommended as a good operating practice. See also Part 99 for requirements concerning DVFR flight plans.					

FAA Form 7233-1 (8-82)

CLOSE VFR FLIGHT PLAN WITH \_\_\_\_\_ FSS ON ARRIVAL

Figure 1. FAA Flight Plan Form

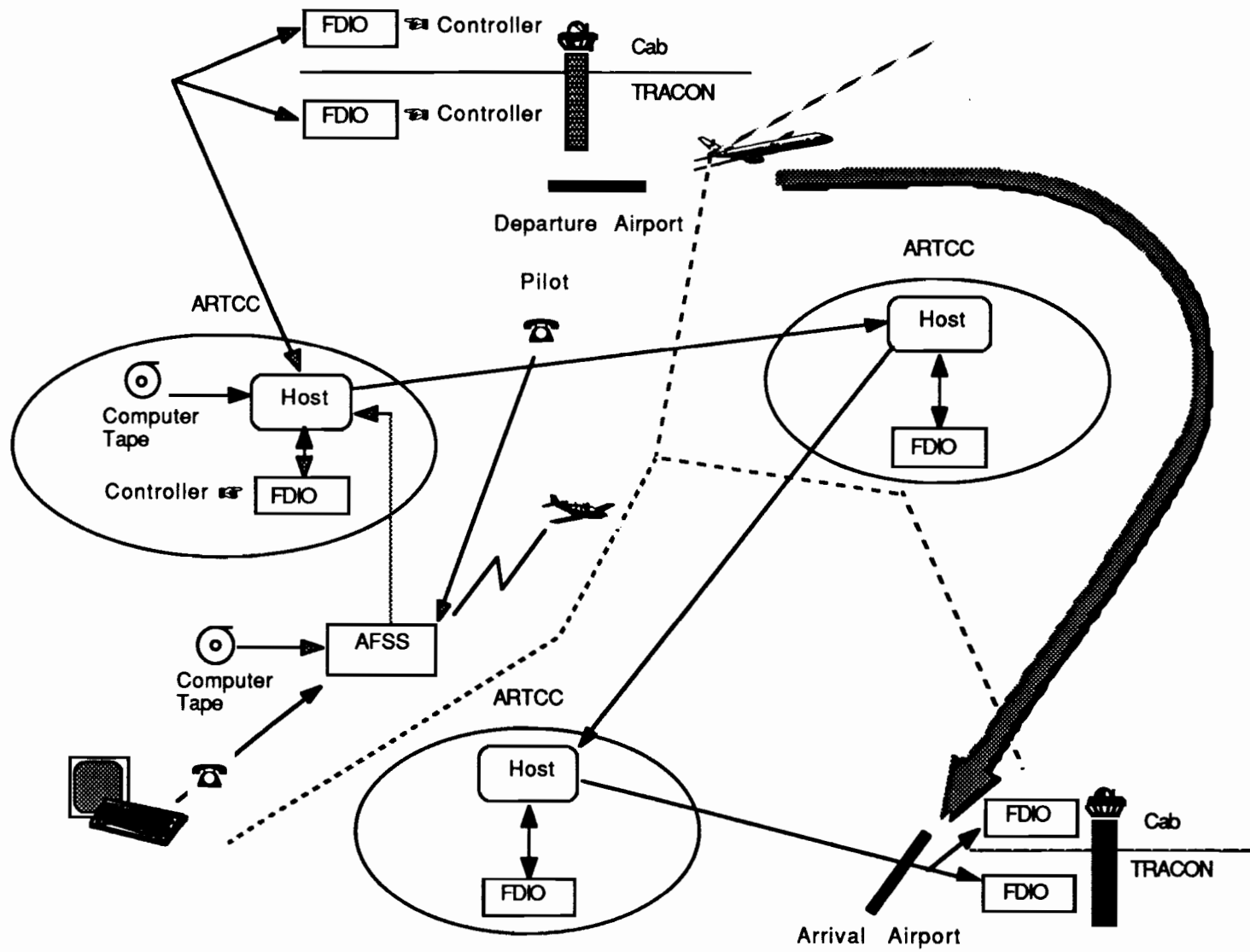

Figure 2. ATC Flight Plan Flow

approximately thirty miles of Logan airport up to approximately fourteen thousand feet plus some lower "shelves" incorporating satellite airports and transition airspace. At a predetermined adjustable time (usually thirty minutes) before departure, a Flight Progress Strip is sent to the Boston Tower and either printed in the Tower cab or TRACON. Flight strips for aircraft departing from Logan are printed on the FDIO printer in the Tower Cab. Flight strips for aircraft departing from satellite airports or overflights within Boston TRACON boundaries are printed in the TRACON. Flight progress information for aircraft arriving at Logan or satellite airports is also available from the Boston ARTCC Host computer but, as described below, is not always printed in the form of a Flight Progress Strip.

Data for VFR aircraft that file a flight plan and request ATC radar services are also available in the Host computer. Flight data for VFR aircraft arriving and departing from Logan or transiting the Boston Terminal Control Area (TCA) that have not filed a flight plan is input into the ARTS computer by a controller but no Flight Progress Strip is generated and the data is not received by the Host computer. The Flight Data position in Boston Tower will insert the flight information into the ARTS for a VFR flight departing Logan. This data includes the aircraft identification, aircraft type, requested altitude, direction of flight, and a single letter designation code indicating the departure control sector that will handle the flight initially. For VFR arrivals, the data is entered by the approach control position that first works the aircraft and gives the clearance into the TCA. The data includes the aircraft identification and type but will not generally include the altitude since it appears on the Mode C readout in the data tag. The destination airport is included and will appear on the data tag.

## **4.2 FLIGHT PROGRESS STRIP DESCRIPTION**

The Flight Progress Strip, depicted in Figure 3, differs slightly from the Flight Progress Strips used by En Route Centers although the differences are not important and ASMS is concerned with terminal Flight Progress Strips. The strip of paper is approximately 8 inches long by 1 inch wide with perforations on the long edges so that the strips can be separated after being printed on the FDIO printer. There are plastic holders available in the TRACON and Tower that are sized to hold the strip and fit into a vertical rack to facilitate reordering of the strips. The data that appears on a Flight Progress Strip depends on whether it is for an arrival, departure, or overflight. The numbers on the strip in Figure 3 are called data blocks. Table 1 lists the data recorded in the data blocks depicted on the strip for the three categories of aircraft. Table 2 is a list of the aircraft equipment suffix codes used in block 3 appearing after the designation for the type of aircraft. Tables 3 and 4 list clearance and miscellaneous abbreviations approved for use by controllers.

1	2	5	8	9	10	11	12
2		6			13	14	15
3		7			16	17	18
4					9A		

*Figure 3. Illustration of Terminal Flight Progress Strip*



TABLE 1

Terminal Flight Progress Strip Data

Data Block	Arrivals	Departures	Overflights
1	Aircraft Identification		
2	Revision number (FDEP locations only).		
2A	Strip request originator. (At FDEP locations this indicates the sector or position that requested a strip be printed).		
3	Number of aircraft if more than one, heavy aircraft indicator "H" if appropriate, type of aircraft, and aircraft equipment suffix.		
4	Computer identification number if required.		
5	Secondary radar (beacon) code assigned.		
6	Previous fix (FDEP locations) or inbound airway.	Proposed departure time.	Coordination fix.
7	Coordination fix.	Requested altitude.	Overflight coordination indicator (FDEP locations only).
8	Estimated time of arrival at the coordination fix or destination airport.	Departure airport	Estimated time of arrival at the coordination fix.
9	Altitude (in hundreds of feet) and remarks.	Machine generated - Route, destination, and remarks. Manually enter altitude/altitude restrictions in the order flown if appropriate. Manually prepared - Clearance limit, route, altitude /altitude restrictions in the order flown, if appropriate, and remarks.	Altitude and route of flight through the terminal area.
9A	Destination airport/point out /radar vector/speed adjustment information. Air Traffic managers may authorize the omission of any of these items if no misunderstanding will result, and they may authorize the optional use of spaces 2A and 10-18 for point out /radar vector or speed adjustment information.	Point out/radar vector/speed adjustment information. Air Traffic managers may authorize the optional use of spaces 2A and 10-18 for this information.	
10-18	Enter data as specified by a facility directive.		
	Radar facility personnel need not enter data in these spaces except when non-radar procedures are used or when radio recording equipment is inoperative.	Items such as departure time, runway used for take-off, check marks to indicate information forwarded or relayed, may be entered in these spaces.	

TABLE 2

Aircraft Equipment Suffix in Data Block 3.

Suffix	Meaning
/A.....	DME, transponder with altitude encoding capability.
/B.....	DME, transponder with no altitude encoding capability.
/C.....	RNAV, transponder with no altitude encoding capability.
/D.....	DME, no transponder.
/M.....	TACAN-only, no transponder.
/N.....	TACAN-only, transponder with no altitude encoding capability.
/P.....	TACAN-only, transponder with altitude encoding capability.
/R.....	RNAV, transponder with altitude encoding capability.
/T.....	Transponder with no altitude encoding capability.
/U.....	Transponder with altitude encoding capability.
/W.....	RNAV and no transponder.
/X.....	No transponder.

TABLE 3

Flight Progress Strip Clearance Abbreviations

Abbreviation	Meaning
A.....	Cleared to airport (point of intended landing).
B.....	Center clearance delivered.
C.....	ATC clears (when clearance relayed through non-ATC facility).
CAF.....	Cleared as filed.
D.....	Cleared to depart from the fix.
F.....	Cleared to the fix..
H.....	Cleared to hold and instructions given.
L.....	Cleared to land.
N.....	Clearance not delivered.
O.....	Cleared to the outer marker.
PD.....	Cleared to climb/descend at pilot's discretion.
Q.....	Cleared to fly specified sectors of a NAVAID defined in terms of courses, bearings, radials or quadrants within a designated radius.
T.....	Cleared through (for landing and takeoff through intermediate point).
V.....	Cleared over the fix.
X.....	Cleared to cross (airway, route, radial) at (point).
Z.....	Tower jurisdiction.

TABLE 4

Flight Progress Strip Miscellaneous Abbreviations

Abbreviation	Meaning
BC.....	Back course approach.
CT.....	Contact approach.
FA.....	Final approach.
I.....	Initial approach.
ILS.....	ILS approach.
MA.....	Missed approach.
MLS.....	MLS approach.
NDB.....	Nondirectional radio beacon approach.
OTP.....	VFR conditions on-top.
PA.....	Precision approach.
PT.....	Procedure turn.
RH.....	Runway heading.
RP.....	Report immediately upon passing (fix/altitude).
RX.....	Report crossing.
SA.....	Surveillance approach.
SI.....	Straight -in approach.
TA.....	TACAN approach.
TL.....	Turn left.
TR.....	Turn right.
VA.....	Visual approach.
VR.....	VOR approach.

### **4.3 USE OF FLIGHT PROGRESS STRIPS AT BOSTON**

The following sections detail the use of Flight Progress Strips in the Boston facility. Figure 4 is included as a summary guide to the detailed descriptions of sections 4.3.1 and 4.3.2.

#### **4.3.1 Use of Flight Progress Strips in the Logan Tower Cab**













The Boston Tower receives Flight Progress Strips for all IFR departures from Logan airport from the Boston ARTCC Host computer. They are printed on the FDIO printer located at the Flight Data controller position in the back of the cab in the northwest corner. The strips are passed clockwise around the cab to the appropriate controller positions as described in the sections below. The strips are normally placed in plastic holders that fit in trays so that the strips are ordered vertically. Flight information for VFR departures is handwritten on blank strips by the Clearance Delivery position. The Flight Data Controller will request a discrete beacon code for VFR aircraft from the ARTS computer by typing in the call sign, direction of flight, altitude, and controller position that will be working the aircraft. That data, now in the ARTS computer, will be available for the correct departure position in the TRACON. The Flight Progress Strips, both the printed IFR strips and the handwritten VFR strips, will eventually progress to the Local Controller (tower) position arranged vertically on a tray. A video camera, positioned above the Local Controller and looking down at the flight strip rack, provides a video image of departure flight strips for display on monitors in the TRACON. The images are sometimes difficult to read because of focusing problems, changing light conditions in the Tower Cab, and shadows or hands of controllers that fall in the field of view.

The Tower Cab does not print Flight Progress Strips for arrival aircraft although the information is available in the Host computer in Boston Center. The assistant Local Controller will hand write the inbound flight numbers on a blank strip (the back of a pre-printed strip form) using the data available from the ARTS.

#### **4.3.2 Use of Flight Progress Strips in Boston TRACON**

Flight Progress Strips for aircraft departing Logan are not printed in the TRACON. Departure information from the Flight Progress Strips in the Tower Cab is displayed on television monitors at the two TRACON positions that initially control departures from Logan. This allows the departure controller to see the additional current information concerning the flights that is handwritten on the strips by the Tower controllers. It also ensures that the departure controllers know the departure sequence. This system has proven inadequate because of monitor readability problems described above.

The Boston TRACON has a FDIO printer located at the Satellite Flight Data Controller position. Flight Progress Strips for aircraft departing from satellite airports are routed to this position from the Host computer at Boston ARTCC. Strips for overflights through Boston TRACON airspace are also routed by the Host to this position. The Host also routes Flight Progress Strips for aircraft departing from satellite airports directly to FDIO printers in the satellite towers. For satellite towers that do not have FDIO printers, data on the Flight Progress Strips is read over land-lines (telephones) to the Clearance Delivery position in the satellite tower by the Satellite Flight Data Controller in Boston ARTCC. The Flight Progress Strips for overflights transiting Boston TRACON airspace are handed by the Flight Data controller to the controller position that will first handle the aircraft.

		Arrivals				Departures				Transitions	
		Logan		Satellites		Logan		Satellites			
		VFR	IFR	VFR	IFR	VFR	IFR	VFR	IFR	VFR	IFR
Boston Tower Cab											
Boston TRACON											





<u>Legend</u>		
		
printed at FDIO	monitored on T.V. from Tower Cab	flight progress strips available but not used; data tag on ARTS sufficient
		
hand written short strip	data entered into ARTS in lieu of flight strip	

Figure 4. Use of Flight Progress Strips in Boston Logan Airport

The Boston TRACON is unlike most other major TRACONS in that it does not use arrival Flight Progress Strips for traffic landing at Logan. This is because the ARTS data tag contains the arrival airport designation (no designation tag means Logan) and all necessary information about the aircraft. This is a local ARTS software modification known as a patch. Flight Progress Strips for satellite arrivals are provided to the Satellite Controller. VFR aircraft arriving at satellite airports and requesting services are given the appropriate frequency for the control position responsible for that airspace and assigned a discrete beacon code by that controller. No flight strip information is entered into the system. VFR aircraft landing at Logan or transiting the TCA are also assigned a discrete beacon code and a "short" strip is prepared in the Tower Cab as described above.

#### **4.4 FLIGHT STAGES AND THE PROCESSING OF FLIGHT PROGRESS STRIPS**

Departing and arriving aircraft proceed through certain stages or states during the departure or arrival process and the Flight Progress Strips move with them. At each stage there is information known to the controller and/or pilot necessary to describe that stage. Additional steps must be taken to transfer the aircraft to a succeeding stage. The purpose of this section is to carefully describe each of the aircraft stages with particular attention to a) information needed by the controlling position, b) Flight Progress Strip status as a function of aircraft stage, and c) the transfer of flight strip information.

##### **4.4.1 Departing**

As an aircraft departs from Boston Logan airport, its Flight Progress Strip proceeds from one controller position to the next. Figure 5, at the end of this section, illustrates the tie-in between the progress of an aircraft through the departure sequence with the concurrent progress of its Flight Progress Strip. In all, the Flight Progress Strip is handled by six different positions in Logan Tower. Each position makes a different use of the Strip. Depending on traffic intensity, some of the positions may be "combined," that is one person may perform the functions of two or more controllers.

##### **4.4.1.1 Aircraft at Gate without Clearance**

Airline aircraft parked at a gate normally have a published scheduled departure time and destination. A "canned" flight plan stored on a computer tape and conforming to airline and FAA requirements is automatically entered into the Host computer at Boston Center in Nashua, New Hampshire and a Flight Progress Strip is printed at the FDIO in the Logan Tower Cab at least thirty minutes prior to the proposed departure time. The pilots will get a copy of this flight plan from their company. If the planned flight is not on computer tape, then it will have to be filed through an Automated Flight Service Station (AFSS) or entered directly into the Host by a Flight Data position. Depending on the length of the flight, there may be more than one "standard" flight route that complies with FAA preferred route requirements. The pilot's choice of route and altitude will depend on weather and winds aloft as well as gross weight. For major airlines and most operators of large transport aircraft, all flights are conducted under instrument flight rules (IFR) regardless of the weather because the aircraft fly at altitudes that require an IFR clearance (in positive control airspace above 18,000 feet mean sea level) and/or it is company policy. Some commuter flights are conducted VFR and it is legal for a large airline transport to file VFR below positive controlled airspace but this is not normally done in the Boston airspace.

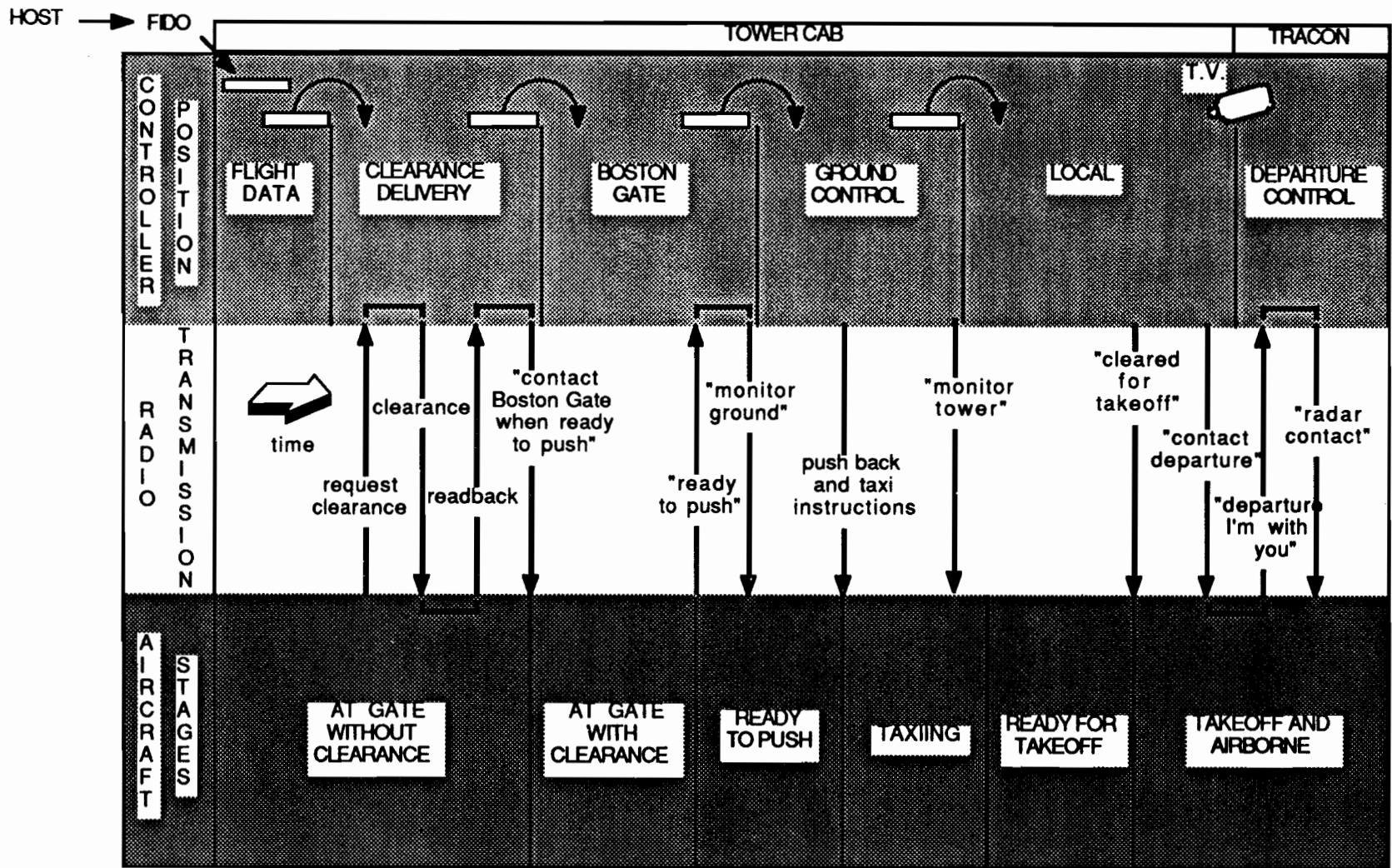

Figure 5. Flight Progress Strip Flow for Departure Aircraft at Boston Logan Airport



Alternatively, the pilot may file an IFR or VFR flight plan directly through an Automated Flight Service Station and this plan will be entered in the computer with the same status as those entered from computer tape. This can be done a) in person at the Automated Flight Service Station facility, b) by phone either through the briefer or specialist or via special answering machines that record flight plans read by the pilot, or c) air filed with a specialist over the air to ground frequency. Any ATC facility, time permitting, can process a request for filing a flight plan and/or an instrument clearance. Instrument clearances or clearances to enter/exit/transit the Boston Terminal Control Area (TCA) can be issued by the controlling facility without the pilot having to file a flight plan. These requests are made by the pilot to the controlling facility over the appropriate air to ground frequency.

Every flight plan in the Host computer has a computer identification number and a revision number (if the flight plan is amended) that is assigned by the computer and stays with the flight plan and is printed on every Flight Progress Strip at all facilities that handle the flight. The computer does not automatically examine the requested routing to check for compliance with current ATC traffic procedures. This is done by the Flight Data positions at the initial controlling facilities. The Flight Data positions in the Tower Cab at Logan and at Boston Center in Nashua will examine the routing and make amendments as necessary. They will also ensure that the routing conforms with agreements with neighboring Centers (and TRACONS for aircraft operating under the Tower En Route Control program) confirming routing over the telephone if necessary. Nevertheless, at times flight plan routes are filed and cleared that do not conform with procedures and routings used by subsequent control facilities and this requires en route amendments. Any amendments or changes which result in a routing different than that requested by the pilot in his flight plan trigger the appearance of the code "FRC" on the Flight Progress Strip which stands for "Full Route Clearance." This indicates that the Clearance Delivery position should read the full routing to the pilot instead of using the abbreviated "cleared as filed" terminology when reading the clearance.

The flight strip with the requested altitude and routing is printed in the Logan Tower Cab and at the first en route sector of the Boston Center approximately thirty minutes before the requested departure time. The Flight Data position removes the strip from the printer and checks the flight plan route for conformance with local traffic flow procedures and with handoff agreements with neighboring facilities. If there are any doubts or questions, the Flight Data Controller will call the succeeding facilities to verify the routing. The Flight Data Controller must also coordinate and record any delays or flow restrictions. The ATC system can impose departure delays due to flow control or en route spacing. Central Flow has a computer program that estimates congestion at specific airports and imposes ground delays for departing aircraft bound for the congested airports. These delays are imposed by specifying Estimated Departure Clearance Times (EDCTs). The Traffic Management Coordinator (TMC) at the Traffic Management Unit (TMU) in the Boston ARTCC relays the EDCT times to the airports via the Flight Progress Strip. In addition, the TMC can issue delays as part of the En Route Spacing Program (ESP) to control traffic flow within Boston Center. ESP spacing delays are imposed to meet handoff metering requests (expressed as miles in trail or aircraft per time unit) from neighboring Centers or TRACONS. The Flight Data Controller can consult one of the Systems Atlanta Information Display pages to determine which airports have current flow control or en route spacing restrictions. The EDCTs and ESP delays are recorded in box 8 on the Flight Progress Strips.

After confirming the routing and coordinating and recording any delays or flow control restrictions, the Flight Data Controller puts the Flight Progress Strip into a plastic holder and places it in one of two rows in front of the Clearance Delivery position. It will remain in this position until the pilot requests his ATC clearance from Clearance Delivery. An IFR flight plan will "time out" after two hours unless a request is made to keep it active to accommodate a delay. The length of time the flight plan will be held can be extended in the event of delays but is limited by the ARTS capacity.

The pilots must also receive a weather briefing before departure, either through their company's weather department or from the FAA. Airline flights must also obtain a clearance from their company dispatch office before departure. The dispatcher checks, among other things, weight and balance, fuel, runway length requirements, conformance with required maintenance, and the filed route. Weight and balance data is used to calculate aircraft takeoff and climb performance including  $V_1$ ,  $V_R$ , and  $V_2$  (the velocities at which the aircraft can continue the take-off in the event of engine failure, the velocity at rotation, and the velocity at lift-off respectively). Sometimes the aircraft will depart the gate without having "the numbers" from its dispatch office and will receive the numbers and clearance from dispatch over its company ARINC radio frequency. If the aircraft departs the gate and enters the taxiway queue and then fails to receive a clearance from the dispatcher, it will have to return to the gate.

#### 4.4.1.2 Clearance Delivery

Historically, IFR clearances have been read to pilots over the Ground Control frequency, and at many less busy airports this is still the case. Congestion of the Ground Control frequency at Logan and other busy airports, however, has dictated the use of a separate frequency known as pre-taxi Clearance Delivery or simply Clearance Delivery. This frequency, published on approach procedure charts, is used by the pilot to request his or her ATC clearance prior to engine start or "push-back" from the gate. Clearance Delivery is a separate position at major airports and the function of the Clearance Delivery controller is to read the ATC clearance to the pilot and monitor the "read-back" for accuracy.

The clearance itself consists of the initial and en route routing (which may include a published Standard Instrument Departure or SID procedure), initial altitude and an expected altitude clearance (along with a time or distance in which to expect the higher altitude), a four-digit beacon or "squawk" code for the transponder, and a frequency for departure control. The portions of the clearance preceded by "expect" are given so that the pilot will follow those altitudes/routings in the event of lost communications. Since most of the major airline flight plans are stored on computer tapes and presumably follow customary ATC routings, it is usual for the route filed to be approved and the route portion of the clearance to be read "cleared as filed" or contain some initial vectors/routings and read "and then as filed" with the pilot having the responsibility for knowing what route was requested. The Clearance Delivery position knows to read the entire routing to the pilot if the code letters "FRC" which stand for "Full Route Clearance" appear on the Flight Progress Strip. This is indicative of a change in the routing from that filed in the flight plan. A readback of the entire clearance by the pilot is customary to ensure accuracy, especially of the beacon code, initial altitude/heading, and departure control frequency. At very busy airports, including Logan, frequency congestion sometimes makes it impractical for a complete readback, and it has become a common practice to abbreviate the readback to essential information with the beacon code, initial altitude and departure frequency numbers being a minimum if the route is as filed.

When the Clearance Delivery controller finishes reading the clearance and monitoring the readback, he or she passes the Flight Progress Strip to the Gate Hold position known as "Boston Gate" who puts it in a stack of aircraft that will be in queue for taxiing. The aircraft now has a clearance with ATC which is good from that moment until whenever the aircraft eventually makes it to the runway and is cleared for takeoff. Ground delays encountered as a result of taxiway or runway queues are not "explained" to those members of the ATC team who control the aircraft after departure; the subsequent controllers simply see the upcoming Flight Progress Strip as the aircraft enters their airspace. Flight Progress Strips are printed at the appropriate controlling facilities along the route based on the recorded departure time and updated actual and estimated times at en route fixes.

#### 4.4.1.3 Boston "Gate"

Clearance Delivery will instruct the airplane to contact "Boston Gate" on the appropriate frequency or to monitor Ground Control depending on the current traffic at Logan. The function of Boston Gate is to assist Ground Control in the sequencing of departing aircraft. This reduces the number of aircraft waiting on the taxiway with engines running and reduces frequency congestion on the Ground Control channel when traffic is heavy and there are a lot of aircraft waiting for taxi clearance. En Route metering requirements of neighboring sectors effect the sequencing of departing aircraft. Since aircraft in the queue on the taxiway cannot be easily resequenced, the Boston Gate position assists in the taxiway sequencing by coordinating the order in which aircraft "push back" with Ground Control. The Flight Data position receives a daily restriction list from the TMU over the GI interface with the Boston ARTCC Host computer. Restrictions, typically expressed as limits (miles-in-trail) at departure fixes, are recorded in box 8 on the Flight Progress Strip of affected aircraft by the Flight Data position. Boston Gate organizes the pool of Flight Progress Strips, visible to the Ground Control position, to facilitate sequencing the taxiway queue to meet in-flight departure restrictions. Boston Gate will update the ESP and EDCT times on the Flight Progress Strip as that information is received. The Flight Progress Strip is transferred to the stack in front of the Ground Control position as he/she requests flights that are ready and meet the departure fix criteria.

When aircraft contact Boston Gate, they are instructed to call back when they are ready to start their engines. Boston Gate will inform the flight of any expected delay imposed by Central Flow or the ARTCC. After any delay, Boston Gate will tell the pilot to monitor the Ground Control frequency for taxi clearance. The aircraft do not contact Ground Control but monitor the frequency until they are called. When Ground Control is ready to authorize "push back," the controller will call the flight directly. Airline employee ramp controllers are responsible for aircraft at the gate and will monitor the aircraft during the push-back and engine start procedures.

Although Ground Control authorizes "push back," the liability for proper separation from other aircraft still lies with the airline and private gate controllers at this point. Theoretically, the aircraft could "push back" at any time and even taxi as long as it remained clear of the active taxiways. As a practical matter, traffic grid locks would occur in the gate area, so aircraft do not depart from the gate until cleared. The airlines however retain responsibility for taxi collision avoidance until the airplane is in the "movement area."

#### 4.4.1.4 Taxiing

Aircraft receive clearance to "push back" and taxi to the departure runway from the Ground Control controller position. Once an aircraft crosses into the "movement area" it is under the jurisdiction of Ground Control. The nominal division of responsibility between Ground Control and the Tower, as described in the Airman's Information Manual, is for Ground Control to control aircraft on the ground until they are ready for departure. The Local Controller controls the active runways for arriving and departing aircraft. The Ground Control position must coordinate crossings of the active runways with the Local Controller. Permission for the pilot to cross runways, including active runways, is implicit in the clearance to taxi to an active runway given by Ground Control unless specifically prohibited by the use of instructions to "hold short" of a runway. From paragraph 241 a. (5) of the Airman's Information Manual:

When ATC clears an aircraft to "taxi to" an assigned takeoff runway, the absence of holding instructions authorizes the aircraft to "cross" all runways which the taxi route intersects except the assigned takeoff runway. It does not include authorization to "taxi onto" or "cross" the assigned takeoff runway at any point. In order to preclude misunderstandings in radio communications, ATC will not use the word "cleared" in conjunction with authorization for aircraft to taxi.

Boston Logan follows this convention and the Ground Controller must coordinate with the Local Controller any time an aircraft crosses an active runway. The use of "hold short" instructions is common. There can be more than one active runway depending on the airport configuration. The airport configuration, in turn, depends on the surface winds, noise abatement procedures, and traffic. A given airport configuration has certain runways used for departures, arrivals or both. For a given airport configuration all runways in use are considered active regardless of the "rate" of use of that runway. It is possible for an aircraft to use a runway that is not considered active for the airport configuration in effect at the time. For example, the primary departure runway(s) may be too short for an aircraft in the heavy category or a high performance military jet fighter. In that case the aircraft can be cleared to takeoff on a longer runway after coordination with the departure controller. Coordination with departure would not be required if the runway was considered an active runway for the airport configuration. In point of fact, *any runway* can be requested by a pilot for take-off or landing in *any direction, regardless of the airport configuration*, but as a practical matter such a request could result in a long delay. It is the pilot's responsibility to ensure that the runway assigned is adequate for the performance of his or her airplane.

#### 4.4.1.5 Take-Off

After an aircraft has crossed all active runways on its taxi route and is approaching the end of the departure runway it will be instructed by Ground Control to monitor the Tower frequency. When departure traffic is high, there will be a queue at the end of the departure runway. Aircraft will continue to monitor the Tower frequency while in the queue. As aircraft enter the queue, the Ground Controller transfers the Flight Progress Strips to the Local Controller in sequence. This is the stack that is viewed on the television monitors in the TRACON. If the aircraft is going to use a runway other than a primary departure runway, this will be coordinated with the departure controller in the TRACON and written on the Flight Progress Strip. Aircraft do not contact the Tower when they are ready to take-off. Instead, the Local Controller knows the aircraft identification and call signs by virtue of their Flight Progress Strips and will contact the aircraft directly as they become first in line. When there is more than one primary runway in use for departures,

the Local Controller will maintain a separate sequenced stack of Flight Progress Strips for each departure runway. Actually, there is a single vertical rack of strips separated by a runway designator strip to create the separate queues. As an aircraft becomes first in line, it will either be cleared for take-off or told to "taxi into position and hold" and subsequently cleared for take-off. The Local Controller must separate departing and arriving aircraft on the same and crossing runways. The Local Controller writes the departure time on the Flight Progress Strip as the aircraft is cleared for take-off. The strip is repositioned on the vertical rack below a separator strip designating departed aircraft. The last three or four aircraft that have departed are kept in this position. The strips are removed approximately three or four minutes after departure.

#### 4.4.1.6 Handoff to TRACON

After take-off, the departed aircraft is instructed to contact Boston departure on the appropriate frequency. The Flight Progress Strip is removed from the rack in front of the Local Controller after a few minutes and the plastic holder tossed in a bin for reuse. The Flight Progress Strip is collected by the Flight Data position and stored in a box by category of flight such as commuter, airliner, etc.

#### 4.4.2 Arriving

Arriving aircraft also follow a sequence as do their Flight Progress Strips although in this case the strips are handwritten "short" strips and the data is taken from the BRITE display of the ARTS data. The process is illustrated in Figure 6 and discussed below.

##### 4.4.2.1 In Boston TRACON Airspace

Aircraft are handed off from Boston Center to Boston approach at metering fixes. Boston TRACON knows the airport configuration (active runways) and vectors traffic according to precoordinated arrival tracks, merging streams of traffic as necessary.

Flight Progress Strip data for arriving aircraft is available in the Host computer at Boston ARTCC. The ARTS computer at Boston has a patch that prints the destination airport in the data tag for arriving aircraft; (actually, aircraft arriving at Logan contain no tag, aircraft arriving at satellite airports contain three letter tags). For this reason, Boston TRACON does not need the Flight Progress Strips and does not print them out at the FDIO printer for arrival aircraft although strips for arrivals at satellite airports are printed and given to the satellite controller as an extra aid in keeping track of traffic. Flight Progress Strips are of less importance for arrivals because future routing is of no concern; the aircraft are handed off from the Boston Center at coordinated fixes, the destination and aircraft type information is on the data tag, and it is known that the aircraft intends to land.

##### 4.4.2.2 Local Handoff

The Local Controller is assisted by the Local 2 position who hand writes data on arrival aircraft on blank strips that are shorter than the normal Flight Progress Strips. Typically, the only information recorded is the aircraft identification and an "H" with a circle to signify aircraft in the "heavy" category or a "T" to signify VFR traffic. If the aircraft is landing on a secondary runway, that will also be noted. The ARTS display, including aircraft data tags, is available in the Tower Cab so that the Local controller can monitor aircraft that are being sequenced by the TRACON. The data is tapped off of the ARTS and is displayed on a special monitor in the Tower Cab known as the Bright Radar Tower Equipment (BRITE) in deference to the high amount of light in the Cab. This equipment has the same readout, display controls, and keypad entry device that are

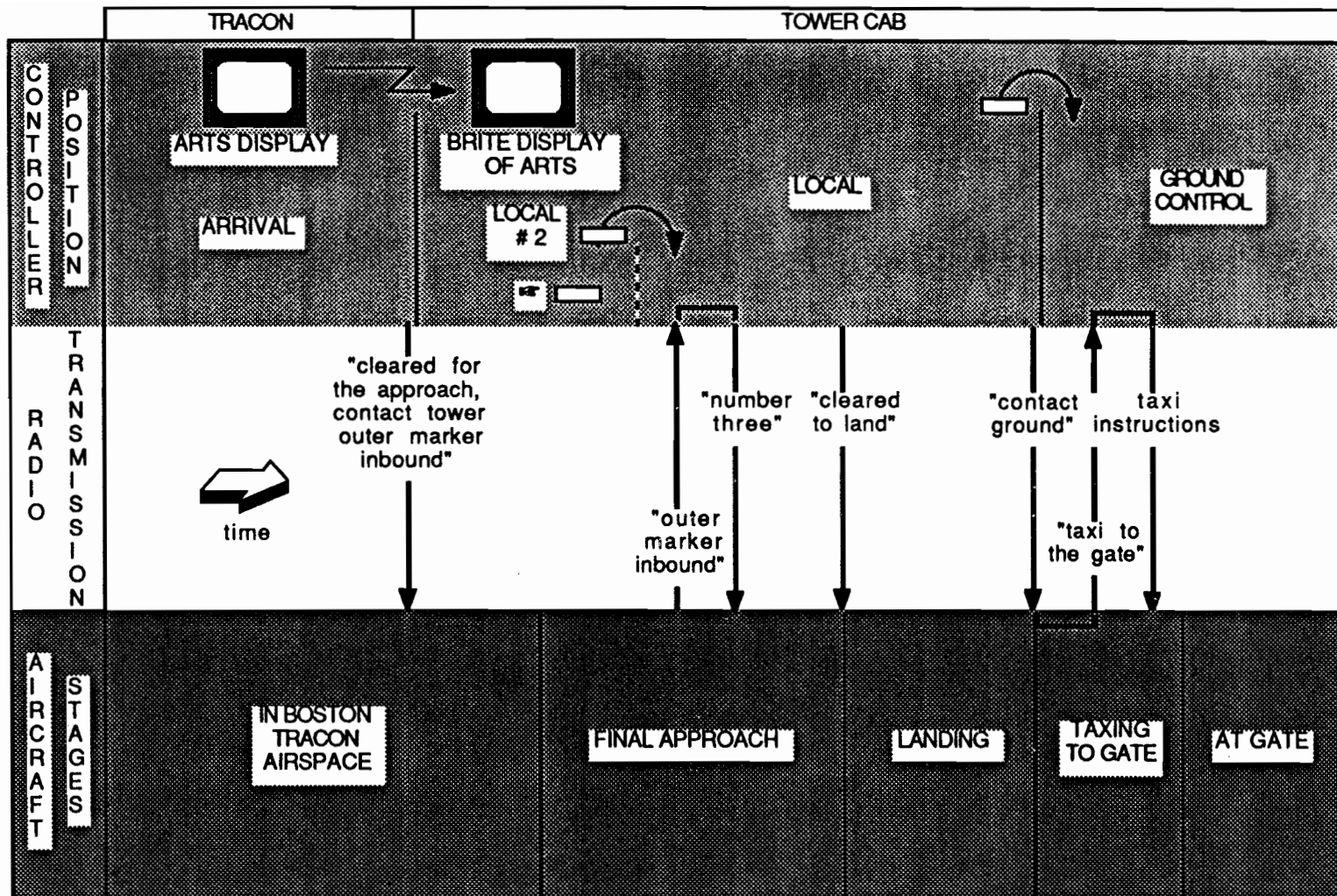

Figure 6. Flight Progress Strip Flow for Arrival Aircraft at Boston Logan Airport

available at radar positions in the TRACON. Aircraft are told when to contact the Tower by Boston Approach Control in the TRACON. During instrument approaches, this is normally at the outer marker when the aircraft is established on the localizer course inbound, approximately five to seven miles from the runway. During visual meteorological conditions (VMC), the aircraft may be given a visual approach, but the flow of traffic and the handoff to the Tower Cab is essentially the same.

#### 4.4.2.3 Ground Control Handoff

After landing, the aircraft is told to turn off of the active runway and contact Ground Control. The handwritten "short strip" is passed to Ground Control position. The pilot contacts Ground Control when clear of the runway and requests taxi clearance to a destination on the airport. The Ground Controller clears the aircraft via a route of letter coded taxiways. At Boston, the Local Controller will not instruct the aircraft to contact Ground Control until the aircraft has cleared all active runways, i.e., if the aircraft turns off of the landing runway and must cross another runway that is in use, the Local Controller will instruct the aircraft to remain on his/her frequency.

#### 4.4.2.4 Out-of-Movement Area

Ground Control is responsible for the safe movement of the aircraft until it transitions out of the movement area where airline personnel will direct the aircraft into the gate. This occurs as the aircraft cross inside the truck lines.

## 5. SYSTEM REQUIREMENTS

The overriding requirement for the Automatic Strip Management System (ASMS) is that it perform at least all of the functions of the current manual system with less than the current workload and distraction imposed on the controller. The description of the current system in the first section of this requirements document therefore becomes an integral part of the ASMS functional requirements. ASMS must be the electronic equivalent of at least the system described in section 4. It must perform all of the services described in section 4 and be compatible with the current operation. Any acceptable design must be compatible with current outside equipment, procedures, and interfaces; i.e. ASMS cannot count on changes to anything else in order to satisfactorily perform. At the same time, a successful ASMS design will facilitate and accommodate future hardware and operational changes and will be designed to integrate easily with future systems such as AAS, TCCC, TATCA, Mode S, and ASTA.

This document is not intended to be a design requirements document, but a description of the functional requirements. It is necessary at times to illustrate "types" of designs in order to describe functional requirements but these should not be taken as design requirements. Any design which accomplishes the same functions will be considered. Indeed, the ASMS program will of necessity involve prototyping of hardware and software designs and controller interfaces to test system acceptance and performance.

### 5.1 HARDWARE AND INTERFACE REQUIREMENTS

The initial ASMS design must integrate with the current system of flight data information flow employed at Logan airport. This involves interfaces primarily with the Host computer through the FDIO and the ARTS computer and display. The required interfaces for information flow are illustrated in Figure 7. The interface between Logan and the "outside world" for flight strips is primarily at the Flight Data positions in the Tower Cab and TRACON.

While Figure 7 is an illustration of "information interfaces," Figure 8 is an illustration of hardware and hardware interfaces consistent with the information flow requirements. The system envisioned would have a stand alone computer (and probably a required backup) with ten separate displays. Each of the displays would be interchangeable and each display would be capable of having the screen customized to any controller position by the supervisor; i.e. the supervisor could decide that a particular screen would be the Ground Control position. Any position will be able to access any other position's display with a single button push so that the Local position could, for instance, access the Ground Control screen by pushing one button.

The ASMS computer must be capable of receiving Flight Progress Strip data that currently goes to the FDIO printer. Any installation must also allow flight plans to be filed from the Flight Data position to the Host, replacing, emulating, or interfacing with the current Wespercorp FDIO equipment. The ASMS software should provide a "buffer" between the Flight Data position and the Host allowing the position to continue with his or her Flight Progress Strip work while ASMS interacts and waits for the HOST in requesting and filing flight plans. The tap into the TATCA interface may be desirable if there is additional useful information that can be gained from the Host but the FDIO interface is still required because ASMS must be able to enter and amend flight plans (send information into the Host emulating the FDIO) and the hardware design should be capable of being introduced at other Towers that may not have a TATCA interface.



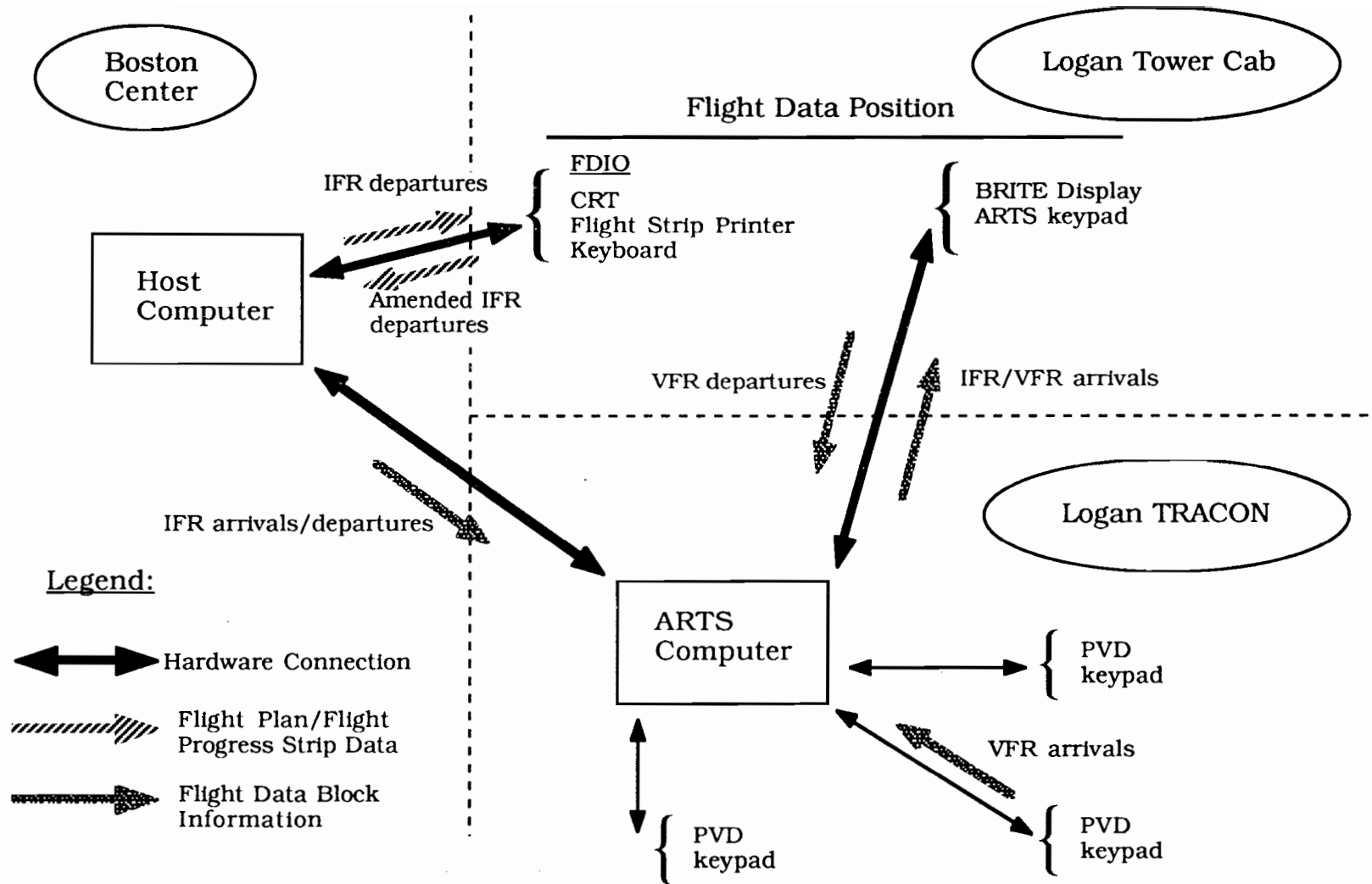

Figure 7. Current Interfaces for Flight Data Information Flow for Flights into or out of Boston Logan

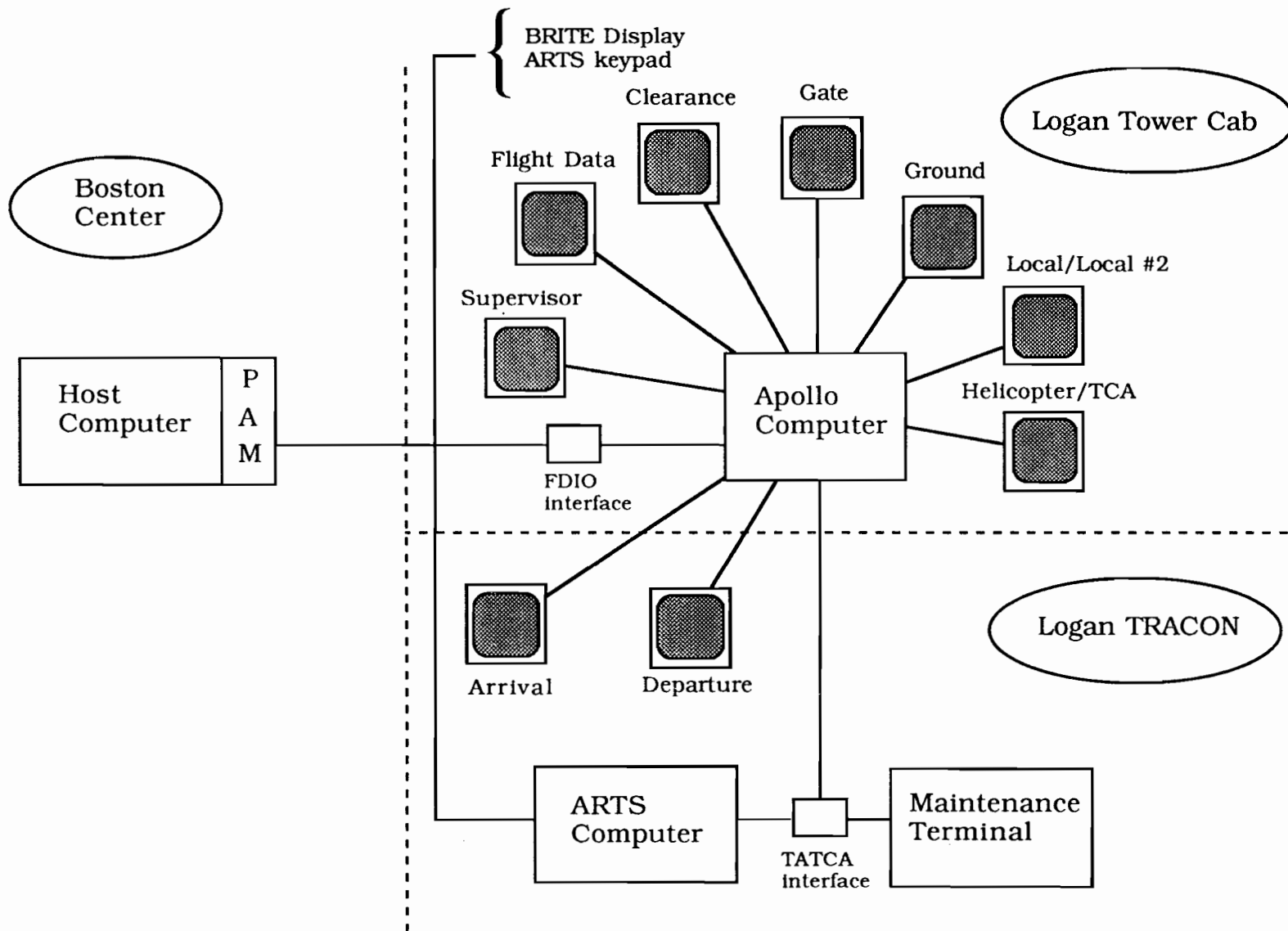

Figure 8. ASMS Interface Requirements

An interface with the ARTS computer is required to obtain data on arriving aircraft. Data on arrival aircraft is needed to replace the current procedure of writing "short strips" by hand based on data from the BRITE display and because it is required in order to display the interaction between arriving and departing aircraft needed by the Local controller display. ASMS will have to emulate the ARTS keypad for entering data block information and therefore interface directly with the ARTS in a manner similar to the existing BRITE/ARTS keypad connection to the Tower Cab.

ASMS must be designed to accommodate possible future interfaces with additional airport equipment and status displays including the Airport Information Distribution System (AIDS), the Low Level Wind Shear Alert System (LLWAS), Automatic Weather Observing System (AWOS), Automatic Terminal Information System (ATIS), Systems Atlanta Information Display (SAIDS) computer, Digital Alimentary Setting Indicator (DASI), airport configuration input, runway visual range (RVR) measuring equipment, runway lighting status, and the computer generated airport users interface line which provides general information between the airport operator and user, etc. The use of this information by ASMS will depend on the design of ASTA and TCCC and their interface with ASMS as well as possible stand alone functions that might be performed by ASMS at towers that might not have ASTA or TCCC.

The question of controller interaction devices will be addressed during the prototyping phase of ASMS but Figure 8 illustrates keyboards at the Supervisor's and Flight Data's positions in recognition of the more extensive inputs required by these positions.

## **5.2. SCREEN DESIGN REQUIREMENTS**

This section describes the requirements for screen design by position. Figures 9a-e at the end of this section are sample illustrations of screens to aid in following the descriptions. In these samples it is assumed that "windows" will be used that can be opened and closed by "clicking" on the appropriate highlighted section of a screen or from menus as appropriate. It is also assumed that some form of single button clicking will transfer information from one position display to the next as the "strip" progresses through the Tower. The actual screen designs and best methods of displaying information will be refined in the prototyping and testing phases.

### **5.2.1 Supervisor**

The supervisor's position and display will allow access to all information and displays. It will have the capability of reconfiguring the entire system so that any physical screen can act to support any controller position. The supervisor will also be able to combine positions which would cause a position display to have the capability of alternately acting as more than one position. The supervisor's position will also be used to input any adjustable parameters such as how far ahead of time (prior to departure) an aircraft ID will enter the queue at the Flight Data position.

The supervisor's position will be used to order the standardized traffic data reports and controller time data and eligibility reports.

These uses suggest a menu driven multiple screen approach with a keyboard. The supervisor does not need to be looking out of the Tower Cab while selecting and ordering a weekly traffic data report so the interface can be one that requires more direct interaction and attention to the system and display. There should be one supervisor's terminal in the Tower Cab and one in the TRACON and they should be identical.

### 5.2.2 Flight Data

The requirements for the Flight Data position terminal are illustrated in Figure 9a. There should be a queue displayed of Flight Strips that are received from the Host. The queue should contain the aircraft ID, three letter destination code, and proposed departure time in UTC (Zulu). The queue should be sorted by order received, last in at the top. There should be controller preference options to resort the queue by category (air carrier, commuter, general aviation) and/or alphabetically. The Flight Data controller's normal mode of operation will be to select (highlight) the aircraft at the bottom of the queue which will generate a window display of a Flight Progress Strip. The Flight Data position will examine the strip for correctness, especially for compliance of the routing with the "East Coast Plan." The ASMS software should incorporate an automatic alert and display of the final destination if it is one of the destinations listed on the SAIDS as having ESP or EDCT delays. The controller will coordinate with TMU to check on gate holds and release times and will move a cursor to the appropriate box on the Flight Progress Strip display and enter the release time. When the controller is finished with the Flight Progress Strip he or she will send it to the Clearance Delivery display with the push of a button or the click of a mouse.

If there are any changes to the flight plan, such as routing or changing the flight plan from IFR to VFR, it will be necessary for the controller to interact with the Host. The controller should have the option of selecting the current Flight Progress Strip and requesting a display for entering changes that will be incorporated in the Host's flight plan. The illustration in Figure 9a shows a Flight Plan form window but it may be more appropriate to abbreviate the window to a different form. In any event, the controller should be able to enter amendments by moving a cursor to the needed area and typing in the change. The interaction with the Host should be transparent to the controller, that is the changes should be stored by ASMS and ASMS should "negotiate" with the Host and simply inform the controller that the amendments have been accepted by the Host. An icon should indicate that the change is pending or accepted so that the controller can proceed with other work. In no case should the system "hang-up" while waiting to receive a response from the Host.

The controller should also be able to access the flight plan data stored in the Host for any aircraft ID in the queue or by typing in the aircraft ID directly. In the event an aircraft calls Clearance Delivery for a clearance and there is no record for that aircraft in ASMS, the Flight Data position should be able to query the Host through ASMS for any information the Host has on that flight. This capability currently exists so there is no software change required in the Host. However, the current system is not user friendly and the ASMS software should provide that user friendly buffer insulating the controller from detailed entry requirements of the Host software.

Finally, the Flight Data position must have the ability to enter a flight plan directly into the Host using the Flight Plan form window. This would be similar to the procedure used to amend a flight plan using a form and cursor and typing the information in from a keyboard.

30 minutes prior to departure  
adjustable

# FLIGHT DATA

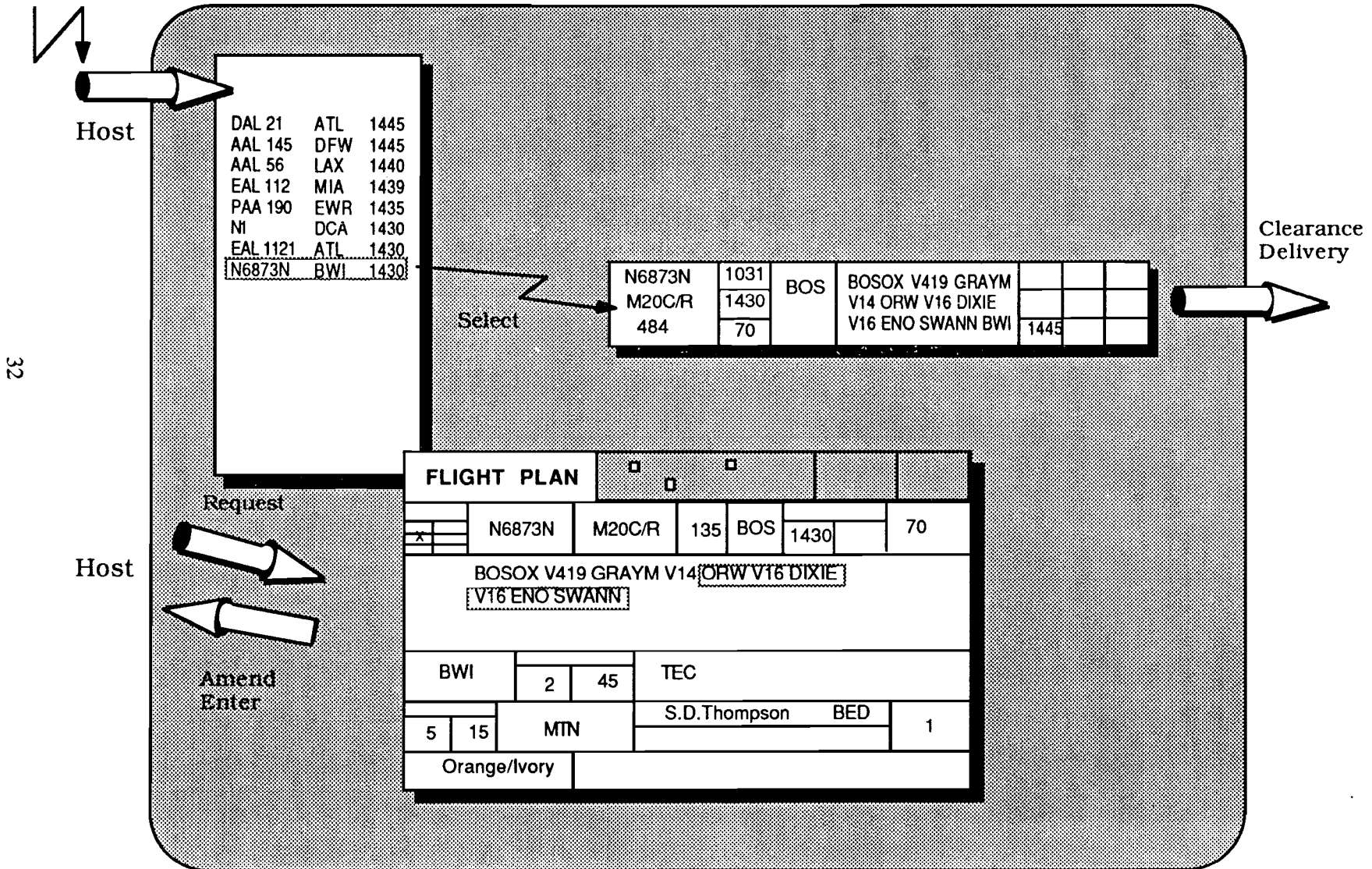

32

Figure 9a. ASMS Flight Data Screen

### 5.2.3 Clearance Delivery

The Clearance Delivery screen, as illustrated in Figure 9b, should have separate queues for air carriers, commuters, and general aviation aircraft and each queue should be sorted alphabetically to facilitate finding and highlighting the flight when the clearance is requested by the aircraft. The queue listing should include the aircraft ID (flight number), three letter destination code, and proposed departure time. The controller should have the ability to produce a window with the Flight Progress Strip format by highlighting an aircraft in a queue. The controller should also be able to create a window with a format customized to the clearance sequence. The clearance sequence is 1) destination, 2) initial routing (runway heading, initial heading, vectors etc.) 3) en route routing (may be cleared as filed), 4) initial altitude, 5) further altitude clearance and time or distance to expect that clearance, 6) radar beacon code, and 7) departure control frequency. A sample clearance delivery window with clearance is illustrated in Figure 9b

When an aircraft calls for clearance on the clearance delivery frequency, the controller will select and highlight the flight producing the clearance window. After reading and verifying the clearance, a cursor will prompt the controller to enter a verification code signaling ASMS that the clearance has been received and read back by the flight crew. Additionally, cursors should prompt for gate and ATIS information codes if they are known. Alternately, the controller should be able to enter these codes in the Flight Progress Strip form window. A single button selection of the flight displayed in the Flight Progress Strip window or clearance window will signal ASMS that after checking for clearance verification the strip should go to the Ground Control position.

### 5.2.4 Boston Gate

The Boston Gate display will receive "strips" from the Clearance Delivery position. There should be queues for each category (air carrier, commuter, and general aviation) of flight as illustrated in Figure 9c. The queues should contain the aircraft ID (flight number), aircraft type, gate, and initial departure fix and be sorted by first come first served with the latest entry at the top and the oldest entry at the bottom. Boston Logan uses three letter designators for local use to depict departure fixes. The VOR fixes, such as Manchester, use the official three letter designator (MHT) that is recognized throughout the system but the intersection fixes, such as BOSOX, which require five letters, are abbreviated to three letters (BOX) for local Boston use.

The Boston Gate position will require the capability of displaying the flights in first come first served order by departure fix as illustrated in Figure 9c. Multiple windows with different departure fixes should be allowed. This is because Boston Gate needs to be able to supply aircraft to Ground by departure fix on a first come first served basis. Boston Gate should, as with all displays, have the capability to select an aircraft in any queue and display the Flight Progress Strip in a window. A cursor prompt will allow Boston Gate to enter the assigned runway. The position should also have the capability to update any information in the notation boxes on the Flight Progress Strip using the same input procedures as the other positions.

# CLEARANCE DELIVERY

Flight Data

Airlines	Commuters	General Aviation
AAL 103 ATL 1445	AJC 112 1445	NI DCA 1450
AAL 435 DFW 1420	AJC 169 1430	N304CG PVD 1445
AAL 517 LAX 1454	AJC 249 1428	N374CG PYM 1430
AAL 581 HOU 1417	AJC 846 1354	N6873N BWI 1445
AAL 981 EWR 1436	AJC 856 1432	
COA 361 DCA 1440	CMD 4845 1457	
COA 367 DFW 1412	CMD 4923 1414	
COA 387 IAD 1440	CVA 893 1423	
DAL 102 ATL 1440	GAA 508 1430	
DAL 586 GSO 1418	GAA 559 1420	
DAL 589 ORD 1456	GAA 689 1440	
EAL 1091 ORD 1430	GAA 767 1330	
EAL 1151 ATL 1425	GAA 832 1445	
EAL 1159 MIA 1447	PRE N6873N 1031	
MID 225 MDW 1459	PRE M20C/R 1430	BOS BOSOX V419 GRAYM D GA
NWA 35 MEM 1356	VLY 484 70	V14 ORW V16 DIXIE
PAA 545 JFK 1438		V16 ENO SWANN BWI 1445
TWA 61 JFK 144		
TWA 754 LAX 143		
UAL 49 SFO 135		
UAL 493 ORD 141		
USA 345 PIT 141		
USA 691 DCA 143		

←  
alphabetized

select

↘  
Add gate and ATIS

ATC clears Mooney 6873N to the Baltimore Washinton International Airport

via turn right, heading 180, vectors to V419, BOSOX,

as filed

climb to maintain 30 expect 70 in 10 min after departure

squawk code will be 1031

contact departure on 121.4

↘  
Boston Gate

Figure 9b. ASMS Clearance Delivery Screen

# BOSTON GATE

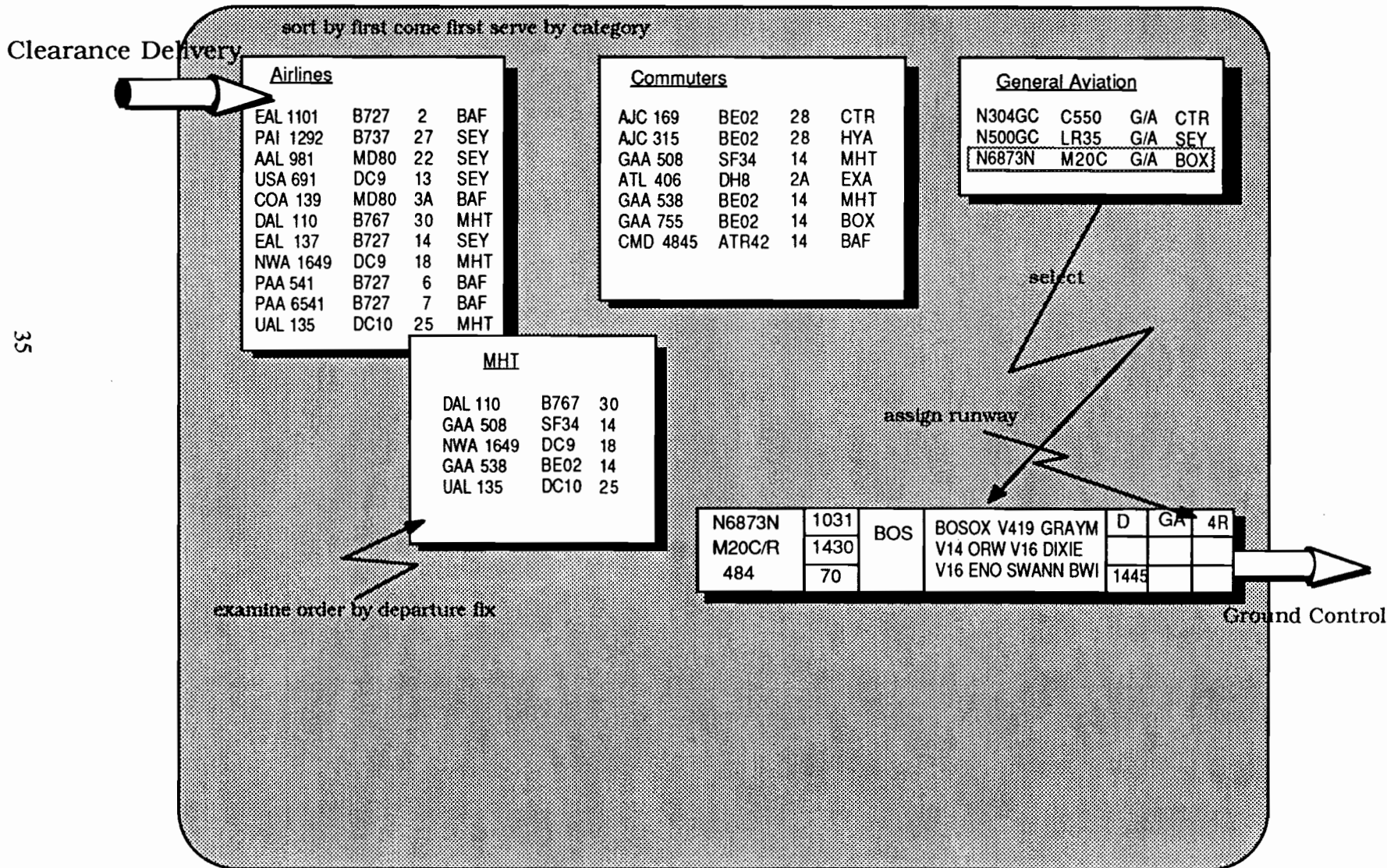

Figure 9c. ASMS Boston Gate Screen



### 5.2.5 Ground Control

The Ground Control position has a complex set of requirements. It is the Ground Control position that authorizes "push back" from the gate so there is a requirement to know which aircraft are at which gates, in the order that they called ready to push. It is also necessary to know from what runway an aircraft will depart and its initial departure fix so that the queueing order for a particular runway will not impose additional separation delays by having aircraft with the same departure fix lined up in order. There are three stages of interest to the Ground Control position for departing aircraft. First, the aircraft at the gate awaiting clearance for push back in roughly the order in which they called. Second, aircraft taxiing out to the departure runway still under control of Ground. And third, aircraft in a queue at the departure end of the runway that need to be transferred to the Local Controller's display. Additionally, Ground Control is concerned with arriving aircraft being handed off from Local as they clear the active runways. The duties of the Ground Control position require that he or she be looking outside almost all of the time. This combination of requirements makes the Ground Control display one of the most challenging.

Figure 9d illustrates the complex combination of data that must be displayed to the Ground Controller. In this example, a runway diagram is included in the center of the screen to provide an orientation. The primary queueing displays are sorted by departure runway with bars separating the aircraft that are at the gate from those taxiing, and those awaiting take-off at the end of the runway. Optional windows are available to sort the departures by initial departure fix noting the departure runway. In the example, Delta 110, still taxiing, is departing runway 4R bound for Manchester VOR as the initial departure fix. The next aircraft using Manchester will be GAA 508 departing on runway 9. GAA 508 is still taxiing out to runway 9 where there is a queue of AJC 169 and Eastern 1101 ahead awaiting departure. In this example, United 135, a DC10, is departing via Manchester and is ready for takeoff but is using runway 15R, probably because it needs the longer length. According to the Manchester initial departure fix queue, however, United 135 is fifth in line for Manchester. Depending on the traffic, he may be cleared early since no other Manchester traffic is ready to go. Delta 1021, a Boeing 727, has just arrived and turned off of runway 9 and will be taxiing to gate 30.

Aircraft at the gate ready for taxi are input into the display queue by Boston Gate. When the aircraft is cleared for push back by Ground Control he or she will adjust the bar that divides the "at gate" aircraft from the taxiing aircraft. Ground will also adjust the bar when the aircraft is in the departure queue at the end of the runway. So, as Delta 110, a Boeing 767, approaches the departure queue for runway 4R, the Ground Controller will "slide" the bar below Delta 110 in the runway 4R queue display. This action will automatically including the aircraft on the Local display.

The interface should allow the selecting of any aircraft for display of the Flight Progress Strip as illustrated. The Ground Controller should also have the capability to reorder aircraft in a queue. It is anticipated that the Ground Control display will offer options to tailor the display for individual preferences.

# GROUND CONTROL

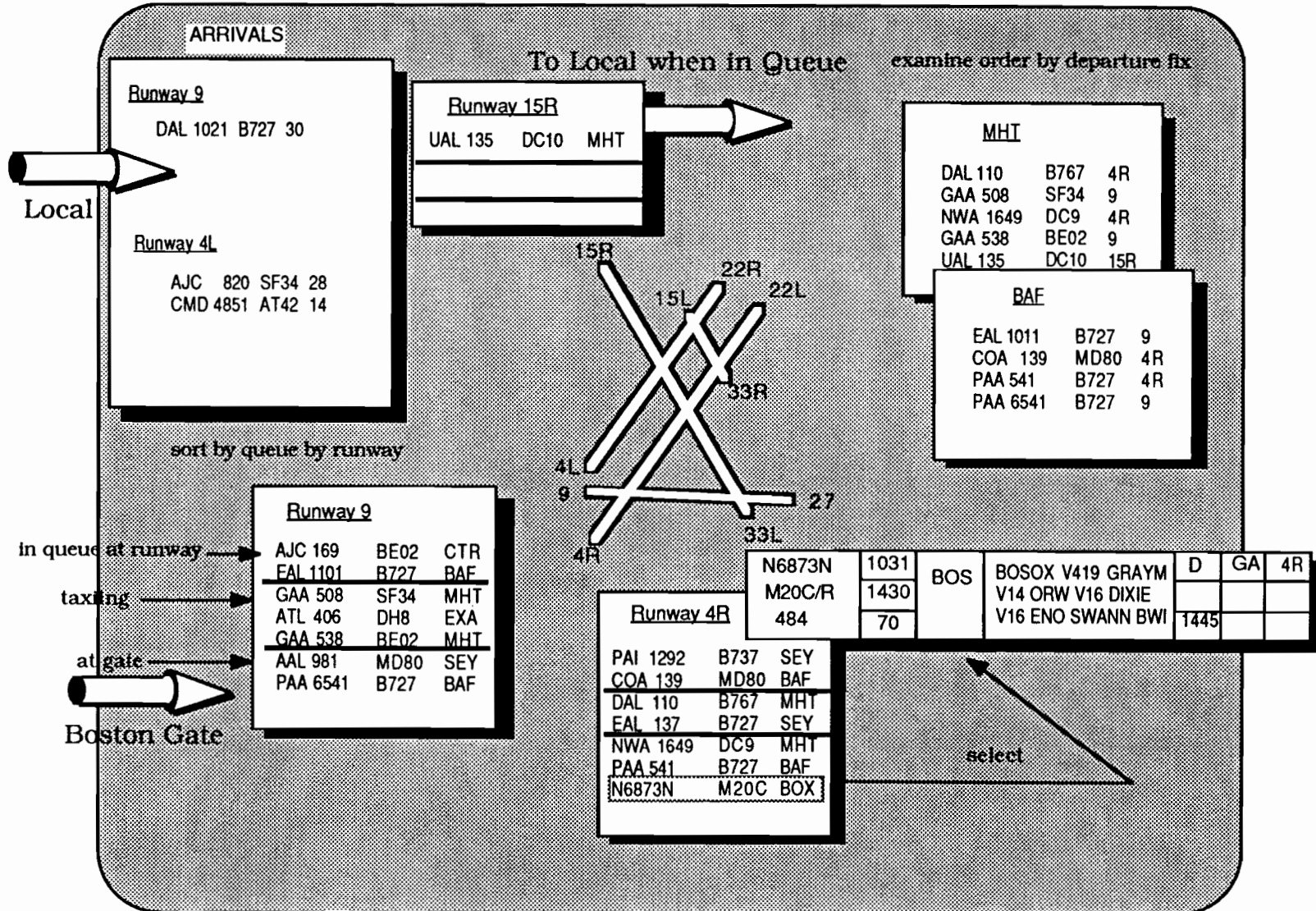

37

Figure 9d. ASMS Ground Control Screen

### 5.2.6 Local Control (Tower)

The Local Controller is concerned with the efficient, coordinated use of multiple runways by arrival and departure aircraft. The primary information needed is the aircraft ID, type, beacon code, and, for departing aircraft, initial departure fix. The display illustrated in Figure 9e is oriented around the airport runway diagram and includes queues for departure aircraft by runway and displays of arriving aircraft with data block information taken from the ARTS display.

The presumption is that Local will have little or no time for interaction with the ASMS display. Currently, a Local 2 position aids the Local Controller at all times and will operate the display. A moving bar will separate the departing aircraft that are coming under the control of TRACON from the aircraft in queue awaiting departure. The aircraft in the runway queue appear as Ground Control slides the bar on his or her display to indicate that the aircraft is now in the departure queue. The aircraft does not contact the Tower but monitors the Tower frequency and the Local Controller will use the displayed queue to identify the aircraft ID as they become number one for departure. This is the procedure used today with the manual Flight Progress Strips. The only required input by the Local (or Local 2) is to move a bar to indicate that an aircraft is departing a runway or push a button to switch an arriving aircraft's "short strip" (based on the ARTS data block) to the Ground Control display.

### 5.2.7 Helicopter/TCA

The helicopter/TCA position will require a modified Local display to accommodate extensive VFR departures as well as the ARTS generated short strips for arrivals.

### 5.2.8 TRACON

The display in the TRACON will be identical to the Local display illustrated in Figure 9e and will require no input or interaction by the controller.

## 5.3 HUMAN FACTORS REQUIREMENTS

It is clear that the design of the interface between the controller and ASMS will be the key challenge in the design of any ASMS system. It is not the intention of this document to solve the man/machine interface problems or dictate a specific design. The approach taken is to point out the functional requirements as is done in Sections 4 and 5.2 and leave the details of design implementation to the prototype phase of the program.

However, there are certain features or requirements that can be discussed at this stage. The presumption has been that there will be some kind of CRT display technology employed and that it will be incorporated in the shelf areas in the Tower Cab where the flight strip racks are now located. The space required by the displays should be no larger than that now required by the flight strip racks and the displays should be as easy to read as are physical flight strips. This will require some advanced display technology because of the varying light conditions in the Tower Cab and because of the requirement for the controllers to look outside. At the very simplest level, the displays could be used to "replace" the flight strips now mounted in racks but it seems clear from the discussions of the current use of flight strips in Section 4 that "customizing" the display by position is desirable. One approach is to use "windows" as is illustrated in Figures 9a-e. The windows can be customized to offer many alternate displays of the data and the display can be "controlled" by the controller.

# LOCAL/TRACON

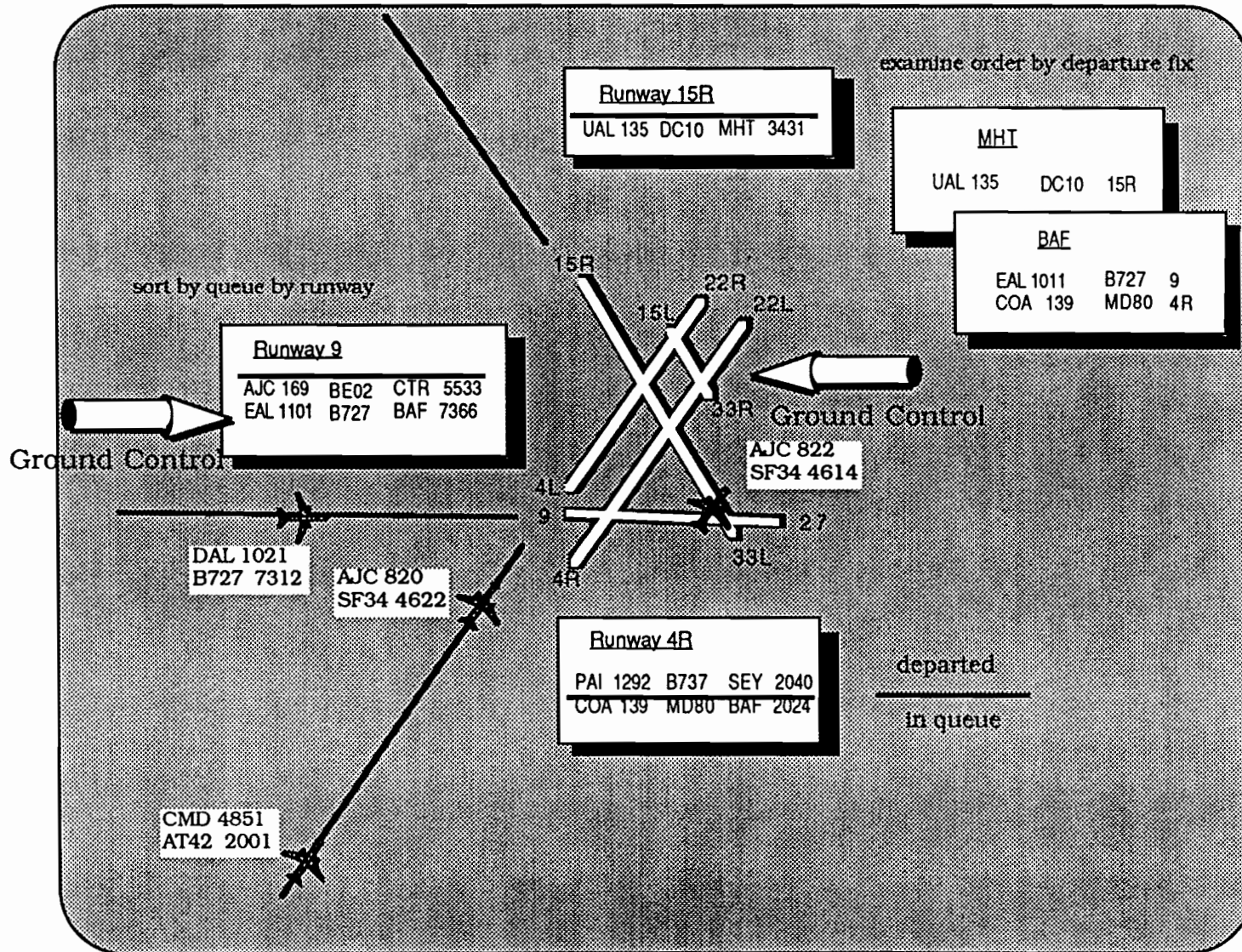

Figure 9e. ASMS Local/TRACON Screen

The human factors requirements on input vary greatly by position. The Flight Data, Clearance Delivery and Gate positions can pay more attention to the CRT screen and have a greater requirement to interact than the Ground Control or Local positions. The Ground Control and Local positions must devote most of their attention outside. Therefore, input devices that employ cursors, a mouse, menus, and a keyboard may be perfectly acceptable to the Flight Data position which must have the capability of entering a flight plan, but would be unacceptable to the Local Controller who inputs little or nothing and must be looking outside.

Some CRT display input and control devices should be common to all positions. For instance, a keypad or push buttons that allow selection and display of another position should be common to all positions. It is important to remember that the controllers change position on a regular basis and that most controllers are checked out and current at more than one position. Therefore it is important that the different ASMS positions incorporate common input/output methods. If a series of buttons across the top of the display are used to select the position display (Ground, Gate, etc.), then that should be common to all CRTs.

Each position follows a repeatable sequence of events with each aircraft most of the time. Therefore, it seems reasonable to design an interaction system that requires the least input for a "normal" sequence. This "next logical sequence" (NLS) approach will allow a controller to process the selected aircraft to its next stage with the single click of a button. For instance, after Clearance Delivery reads a clearance and monitors the readback for an aircraft, a single button click should remove that aircraft from the Clearance Delivery display, close all open windows, indicate verification of the readback to the ASMS computer, and send the strip to Boston Gate. This NLS approach can be incorporated in queue displays so that the next logical aircraft in sequence is automatically selected or highlighted for selection.

The answers to the most acceptable interaction devices, designs, and hardware will be found during the prototype testing phase.

## **5.4 DATA BASE REQUIREMENTS**

### **5.4.1 Archival and Retrieval Requirements**

The Flight Progress Strip images that progress through the ASMS system should be stored on line for at least 48 hours and should be automatically stored off line on a real time basis. The off line storage device should be capable of storing at least one weeks worth of Flight Progress Strip images and have small inexpensive removeable cartridges or disks that would allow indefinite storage of data. The Flight Progress Strip images that are stored should be time marked by ASMS by position and include all data input by the controllers. These should also include the "short strips" taken from the ARTS computer data blocks and generated by ASMS.

Menu driven software, accessible at the supervisor's terminal, should allow the supervisor to search through the on line or off line data base of stored Flight Strip images to find Flight Strips that meet the search criteria. The search criteria should include at least aircraft ID, time period, beacon code, initial departure fix, routing arrival or departure runway and type. The search software should allow for input of multiple search criteria, i.e. the program should be able to find all American Airlines Boeing 727s that departed on runway 4L between 1400Z and 1600Z.

#### 5.4.2 Traffic Data Recording Requirements

Using the on and off line data base storage system described above, ASMS should offer a menu driven software system accessible to the supervisor to generate traffic data summary reports. The system should be capable of summarizing the data by: 1) arrivals and departures; 2) aircraft category (heavy, large, small) or (air carrier, commuter, general aviation); 3) runway used; 4) time period. Standardized report formats and parameters should be stored so that the supervisor can select a standard report from a menu.

#### 5.4.3 Operational Recording and Eligibility Requirements

The ASMS system should keep track of the acting controller by position by requiring a log-in. The log-in should allow the recording of training time by trainer and trainee. This data should be stored with the Flight Progress Strip data. A menu driven software package should be provided that allows the supervisor to prepare standardized summary time reports including training and overtime. The system should provide the supervisor with real time eligibility checks which includes algorithms for position certification, training, length of time at position, or any other constraint that would determine a persons eligibility to act as a controller at that position. In no case should the ASMS software prevent a controller from logging in, even if it violates a preset constraint.

### 5.5 OPTIMUM QUEUE MODULE

ASMS will have access to data on departing aircraft by gate, aircraft type, and routing including initial departure fix. It is possible that a knowledge based algorithm could be developed to optimize the departure sequence by runway taking into account arrivals (both known from ARTS or Host or predicted based on statistics), airport configuration, separation standards, flow control limits to initial departure fixes, and aircraft performance limits. The software design should at least make provisions for a software module designed to optimize departure queues. This could serve as a test bed for future ASTA software and for integration with TATCA.