The Development of Phased-Array Radar Technology

Alan J. Fenn, Donald H. Temme, William P. Delaney, and William E. Courtney

■ Lincoln Laboratory has been involved in the development of phased-array radar technology since the late 1950s. Radar research activities have included theoretical analysis, application studies, hardware design, device fabrication, and system testing. Early phased-array research was centered on improving the national capability in phased-array radars. The Laboratory has developed several test-bed phased arrays, which have been used to demonstrate and evaluate components, beamforming techniques, calibration, and testing methodologies. The Laboratory has also contributed significantly in the area of phased-array antenna radiating elements, phase-shifter technology, solid-state transmit-and-receive modules, and monolithic microwave integrated circuit (MMIC) technology. A number of developmental phased-array radar systems have resulted from this research, as discussed in other articles in this issue. A wide variety of processing techniques and system components have also been developed. This article provides an overview of more than forty years of this phased-array radar research activity.

THE CONCEPT OF ARRAY ANTENNAS was certainly not new when Lincoln Laboratory's phased-array radar development began around 1958. Early radio transmitters and the early World War II radars used multiple radiating elements to achieve desired antenna radiation patterns. The Army's "bed spring" array, which first bounced radar signals off the moon in the mid-1940s, is an example of an early array radar. A new initiative in the 1950s led to the use of rapid electronic phasing of the individual array antenna elements to steer the radar beam with the flexibility and speed of electronics rather than with much slower and less flexible mechanical steering. Many industrial firms, government laboratories, and academic institutions were involved in developing methods for electronic beam steering. In fact, this research area in the 1950s could be characterized as "one thousand ways to steer a radar beam." Bert Fowler has written an entertaining recollection of many of these efforts from the 1950s to the present [1].

Many skeptics at that time believed a workable and

affordable array radar with thousands of array elements, all working in tightly orchestrated phase coherence, would not be built for a very long time. In retrospect, both the enthusiasts and the skeptics were right. The dream of electronic beam movement was achievable, but it has taken a long time to achieve the dream, and it is not yet fully realized—we still need to reduce the cost of phased-array radars. We are certainly encouraged, however, by the progress in modern solid state phased arrays.

The Beginning

Lincoln Laboratory started working on phased-array radar development projects around 1958 in the Special Radars group of the Radio Physics division. The initial application was satellite surveillance, and the level of national interest in this work was very high after the Soviet Union's launch of the first artificial earth satellite—*Sputnik I*—in 1957. The Laboratory had played a key role in the development of the Millstone Hill radar under the leadership of Herbert G.

Weiss, a radar visionary. At that time, the Millstone Hill radar was one of the few radar instruments in the world with satellite detection and tracking capability. Weiss, along with others in the U.S. Air Force, foresaw that the United States would soon need the capability to detect all satellites passing over its territory. The volume of radar surveillance needed to accomplish this task was clearly enormous, which meant that radars of great power, antenna aperture, and beam agility would be required.

One approach to solving this surveillance problem was to build a large planar array of some five thousand UHF elements. Weiss's intuition told him the nation was not yet equipped with the capability to produce reliable low-cost components that would allow engineers to implement a radar with five thousand individual transmitters and receivers. The country, however, did have some big UHF klystrons in the Millstone Hill radar transmitter (2.5-MW peak power, 100-kW average power), and klystrons such as these could be incorporated into a phased-array radar of sorts. Thus began a search of a variety of hybrid mechanically scanned and electronically scanned antenna-array configurations that would use a few of these big klystrons.

Figure 1 is a drawing of the favored hybrid concept, which featured a cylindrical receiver reflector 140 ft high by 620 ft long [2]. Three rotating vertical linear arrays formed multiple receive beams in eleva-

tion angle, which were mechanically scanned across the cylindrical reflector. The klystron transmitters were coupled to three horizontal linear arrays that did not use the reflector, nor did they electronically scan. They formed a fan beam in elevation angle, which was scanned across a large portion of the sky as a result of the mechanical drive in a large center hub (hence this massive machine was given the irreverent nickname "centrakluge"). Average power output from a group of 900-MHz klystrons was to be one megawatt. This hybrid array concept had great power, great receiving aperture, and a rapid wide-angle scan capability. It was configured to survey huge volumes of space, so that one installation could detect all satellites passing over the United States up to an orbital altitude of three thousand nautical miles.

The Laboratory's focus at the start of this development effort was to find efficient ways to build the long linear phased arrays for the receivers. A variety of beamforming schemes were investigated, including beamformers at intermediate frequencies (where high losses could be tolerated), radio-frequency (RF) diode-switched phase shifters (where losses needed to be kept very low), and RF multibeam beamformers.

This hybrid electronic-scan/mechanical-scan approach had critics who argued that it could track satellites only in a track-while-scan mode, and it could not track high-interest satellites outside of its somewhat restricted vertical search window. The nation

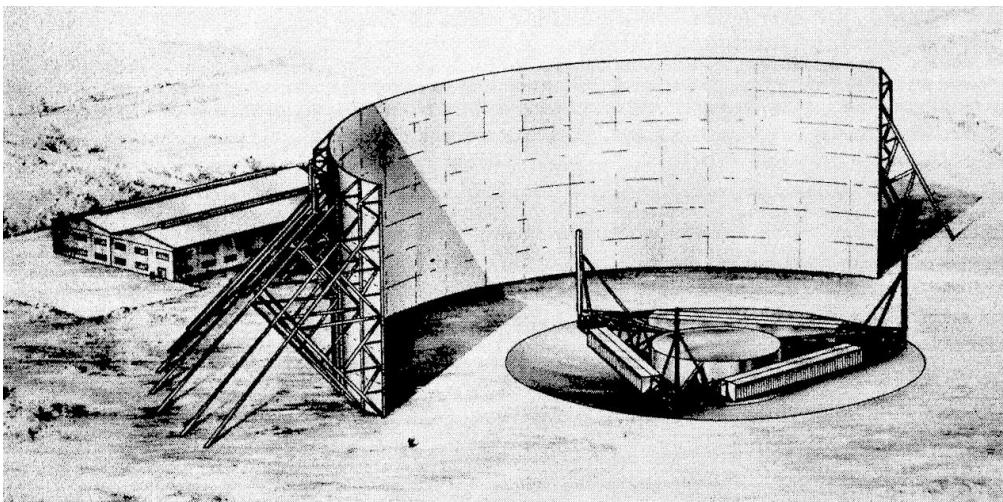

FIGURE 1. Drawing of a proposed 1950s-era hybrid phased-array radar that combined mechanically scanned and electronically scanned antenna-array configurations.

seemed to favor the five-thousand-element, full phased-array approach, an option that was encouraged by a significant U.S. Air Force effort on electronic scanning array radar (ESAR) at the Bendix Corporation. Also, many engineers in the defense community of that era really wanted the nation to build a full planar phased-array radar.

The increase in national interest in ballistic missile defense shifted everyone's focus toward planar phased arrays because the challenges and intricacies of active missile defense would demand every ounce of radar beam agility, flexibility, power aperture, and wide-angle scan that the radar community could muster. Therefore, interest in linear arrays faded—planar arrays were what was needed—but the nation was still a long way from achieving the dream of an affordable planar phased array.

The Early Years

By 1959, a cadre within the Special Radars group at the Laboratory had formed around a phased-array visionary, John L. Allen, to push the development of phased arrays for a wide variety of military missions, with ballistic missile defense as the mission for which such radars were most obviously needed. Allen's goal was to conduct a broad development effort on arrays, starting from array theory and extending to practical hardware developments, in order to improve the national capability in phased arrays to a point where we had reliable and reasonable-cost array components, a variety of beam-scanning techniques, and a sound understanding of array theory. The work had to have a practical orientation, and the Laboratory's effort had to connect with and influence the wide diversity of array research going on in industry and government laboratories.

Thus in 1959 the Laboratory launched a broad attack on new developments in theory and hardware, and through the ensuing five years the phased-array effort functioned very much as an intellectual open house to share insights with other researchers and as a clearinghouse to help industry try out its ideas. The Laboratory developments were chronicled in a series of yearly reports entitled "Phased-Array Radar Studies," which were best-sellers in the array community [3–6].

The Sixteen-Element Test Array

The strong emphasis on making phased arrays into practical devices led to the construction of a 900-MHz, sixteen-element linear-array fixture as an array test bed, where array components, such as antenna elements, low-noise amplifiers, intermediate-frequency (IF) amplifiers, mixers, transmitters, and beamforming techniques could be tried, tested, and exercised. The array test bed was mounted as a feed looking into a parabolic cylinder reflector, and this whole antenna structure was mounted on a rotating pedestal and housed in a radome on the rooftop of Lincoln Laboratory's C Building, as shown in Figure 2. A wide variety of embryonic phased-array receiver and transmitter components were developed and tested in this sixteen-element array over the first five years of the Laboratory's program.



FIGURE 2. Sixteen-element linear-array test-bed facility at Lincoln Laboratory in 1960. Phased-array components such as antenna elements, low-noise amplifiers, intermediate-frequency amplifiers, mixers, transmitters, and beamforming techniques were tested in this facility.

Phased-Array Components

The initial experimentation with array antenna elements started with log-periodic structures that were reported to have a desirable low mutual coupling. The early experiments, however, showed that dipole elements were better candidates for arrays, and much of the ensuing work was on dipole radiators.

Low-noise front-end amplifiers for phased-array receivers were a substantial area of investigation. Work started with a complex electronic device called the electron-beam parametric amplifier, invented by Robert Adler at Zenith Radio Corporation and Glen Wade at Stanford University. More conventional diode-based parametric amplifiers were also investigated. The desire for simpler and lower-cost approaches led to work on tunnel-diode amplifiers; this effort finally settled on low-noise transistor amplifiers with the advent of the field-effect transistor.

IF amplifiers, mixers, and transmitters using medium-power tetrodes were also developed and tested in configurations that would allow them to fit in a planar-array structure at 900 MHz.

One of the major efforts was in the development of various ways to steer the radar beam electronically. Beamformers that worked at IF were one of the earliest approaches, and a variety of schemes were built and tested. Techniques that worked directly at RF were also investigated. One invention of that time was the Butler beamforming matrix, which received early and comprehensive testing at Lincoln Laboratory after its invention by Jesse Butler of Sanders Associates around 1960 [7, 8]. An interesting nuance of the Butler matrix was its microwave wiring diagram, which was identical to the computational flow graph of the fast Fourier transform that hit the headlines a number of years later. In retrospect, this similarity was no surprise, because the Butler matrix was indeed a Fourier transformer [9, 10]. In fact, the Laboratory built a low-frequency version of the Butler matrix to serve as a Fourier transformer for a radar burst-waveform-matched filter.

The search for digital devices that could electronically scan radar beams led to a major research effort in digital diode-switched microwave phase shifters. The Laboratory's work in this area contributed substan-

tially to the development of workable diode phase shifters that found their way into a wide variety of phased-array radars. This diode phase-shifter work and related ferrite phase-shifter work are described in a subsequent section of this article.

Retrospective on the Early Years

There were several enduring values to the phased-array work in these early years. First, the Laboratory quickly became "wet all over" in this new technology of phased arrays. The work covered a broad front, including theory, hardware, experimental arrays, and systems analysis on military problems requiring phased arrays. Second, the focus on driving for the practical, low-cost, highly reliable components that would make phased arrays a viable future option helped set the appropriate tone for the national research agenda in phased arrays of that era.* Third, the Lincoln Laboratory group under the leadership of John Allen was very much an open house and a forum for industry, academic, and government workers of that day. In this fashion, the work performed at the Laboratory had an amplified impact that went well beyond the efforts of the ten or so researchers in the Laboratory phased-array radar group.

The Ensuing Years

In subsequent years, Lincoln Laboratory made significant contributions to phased-array technology, including array-element design, phase shifters, solid-state transmit-and-receive modules, gallium-arsenide monolithic microwave integrated circuits, and array calibration and testing.

* In 1970 Lincoln Laboratory cosponsored a phased-array symposium [11] in New York City, which brought together many contributors to the field of phased-array technology. The symposium covered all the major aspects of phased-array theory, design, and manufacturing, including array-element design, feed networks and beam-steering methods, phase-shifter technology, solid state technology, and array-testing techniques. Carl Blake and Bliss L. Diamond of the Laboratory were prominent in the organization of this significant phased-array meeting, which assessed the state of the art and provided a comprehensive, up-to-date source of information on phased-array antennas.

Array-Element Design

One of the fundamental difficulties in designing a phased array is that significant portions of the microwave power transmitted by one element of the array can be received by the surrounding array antenna elements. This effect, which is known as array mutual coupling, can result in a substantial or total loss of transmitted or received radar signal, depending on the coherent combination of all of the mutual-coupling signals in the array. The amplitudes and phases of the array mutual-coupling signals depend primarily on the shape of the radiating antenna elements, the spacing between the array elements, and the number of radiating elements. There are as many different design possibilities for phased arrays as there are dozens of different radiating array elements to choose from, and the spacing and number of radiating elements can vary widely, depending on the scanning requirements. Naturally, we needed to understand fully the mutual-coupling aspects of whatever radiated element was selected. Thus the Laboratory investigated many different array-element designs, taking into account mutual-coupling effects.

The Laboratory's investigation of the theory of array antennas began in 1958 and has continued through the ensuing years. Allen's early work contributed markedly to the understanding of array antennas in that era [12]. There was a strong focus on understanding and modeling array mutual coupling and its impact on array performance. As described below, this theoretical and experimental work was continued at the Laboratory by Diamond [13], Diamond and George H. Knittel [14], Gerasimos N. Tsandoulas [15–19], and Alan J. Fenn [20, 21].

A significant challenge in designing phased arrays is meeting requirements of scan volume and bandwidth while avoiding blind spots and maintaining low sidelobes [11, 22–26]. Figure 3(a) shows the concept of a corporate-fed phased-array antenna that uses phase shifters to electronically steer the radar beam over the scan sector. The RF source produces a radar waveform that is divided up into individual paths called element channels, each containing a phase shifter and amplifier.

Figure 3(b) shows an idealized element-radiation

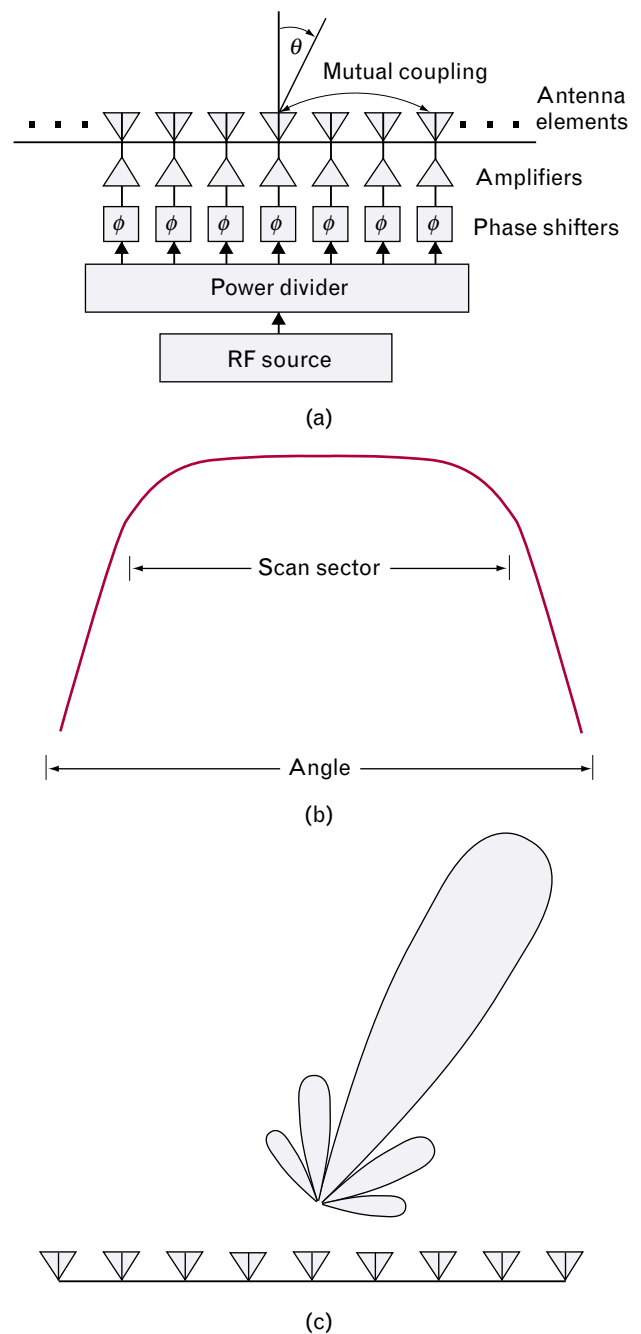

FIGURE 3. General concept of a phased-array antenna that electronically combines element patterns to point the radar beam in a particular direction. (a) The antenna uses phase shifters to steer the radar beam electronically over the scan sector. The radio-frequency (RF) source produces a radar waveform that is divided up into individual paths called element channels, each containing a phase shifter and amplifier. (b) An idealized radiation pattern from a single antenna element covers the scan sector, with signal strength dropping outside of the sector. (c) When all the phase shifters of the array are properly aligned, the array produces a main beam in the desired pointing direction.

pattern that covers the scan sector, with signal strength dropping outside of the sector. When all the phase shifters of the array are properly aligned, the array produces a main beam in the desired pointing direction, as shown in Figure 3(c). Generally, the corporate feed is designed with minimal crosstalk between channels. Once the signals have reached the radiating antenna elements, however, a significant amount of crosstalk (i.e., array mutual coupling) occurs. The amplitudes and phases of these mutual-coupling signals can seriously impact the performance of the phased array.

If the array-element spacing is around one-half-wavelength, substantial amounts of mutual coupling can occur. This coupling manifests itself in often deleterious changes in the element's radiation pattern and its reflection coefficient. Unless care is taken in the design of the array, blind spots in the radar-scan sector can occur. These blind spots are angles where the element pattern has a null and the reflection coefficient of the array has a peak close to unity, as depicted in Figure 4. At these blind spots the total radar signal is significantly reduced in amplitude.

Sometimes we would like to place a blind spot in directions where it is undesirable to transmit or receive radar energy. For example, Figure 5 compares a broadside-peak radiator (dipole or waveguide aperture) and a broadside-null radiator (monopole antenna). The latter element is useful when broadside radiation is undesirable, such as in reducing broadside clutter and jamming. As the radar beam is steered away from 0° (broadside) toward 60° , the conventional broadside-peak-type element radiation pattern drops off, but the broadside-null-type element radiation pattern increases to a peak at about 45° to 50° .

Early developments of phased-array radiating element technology were conducted at Lincoln Laboratory during the period from 1959 to 1967. Beginning in 1959, the Laboratory contributed to the theoretical understanding of phased arrays, particularly the effects of array mutual coupling on the performance of various configurations of dipole arrays; for example, the reports by Allen et al. [3–6, 27–32]. Figure 6 shows one of the early L-band dipole-phased-array test beds used in measuring array-element patterns, mutual coupling, and array active-scan impedance.

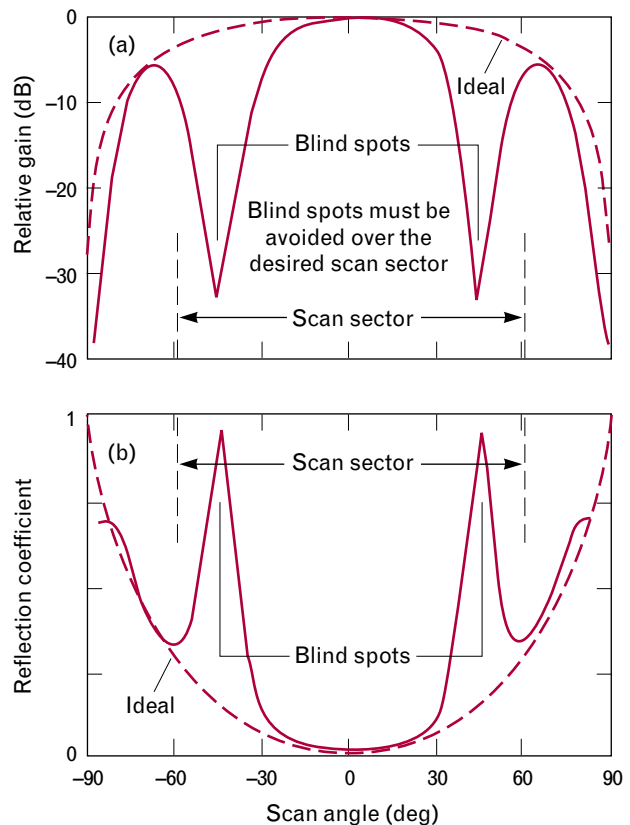

FIGURE 4. Conceptual images of blind-spot occurrence in a phased-array antenna. These results are typical of an array designed without regard for array mutual-coupling effects. A blind spot occurs when either (a) the array element pattern has a null or (b) the element reflection coefficient has unity magnitude. The blind spot is often caused by array mutual coupling, which tends to direct the radiation in the plane of the array as a surface wave, rather than as a wave propagating away from the array. Careful design of the array element shape, size, and spacing can prevent the occurrence of blind spots.

Phased-array radiating elements, primarily for airborne applications, were investigated at Lincoln Laboratory during the period from 1968 to 1980. Waveguide elements of various designs (rectangular, square, and circular) were studied in great detail, both theoretically and experimentally [13–19]. Diamond analyzed waveguide elements [13]; later, with Knittel, he developed a phased-array-element design procedure [14]. They also showed that small arrays can be used effectively to design array-radiating elements for large arrays [33].

A computer program known as RWED (rectangular waveguide-element design) [34] was developed for

phased-array analysis, using the Diamond theoretical formulation. This software was widely circulated by the Laboratory to the phased-array industry, where it has been used extensively for designing waveguide phased arrays.

In the early 1970s, Tsandoulas at Lincoln Laboratory utilized the waveguide-array-analysis software developed by Diamond to design low-sidelobe waveguide phased arrays for airborne application in a displaced-phase-center radar antenna [15]. Figure 7 shows a set of measured low-sidelobe L-band phased-array beam-scanning patterns for the Multiple-Antenna Surveillance Radar (MASR) (see also the article entitled “Displaced-Phase-Center Antenna Technique,” by Charles Edward Muehe and Melvin Labitt, in this issue).

In the mid-1980s, Lincoln Laboratory was heavily involved in the development of a phased-array an-

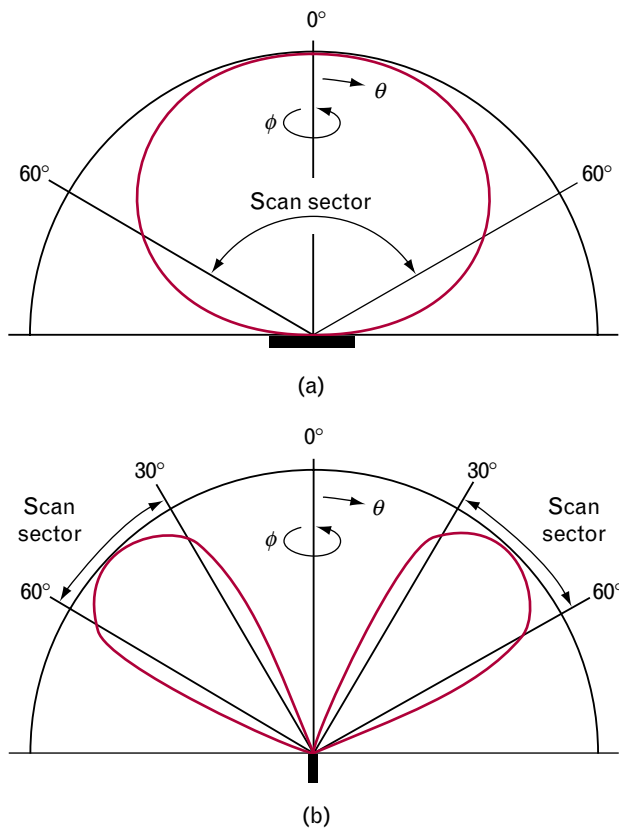

FIGURE 5. The radiation patterns of (a) a conventional broadside-peak radiating element (dipole or waveguide) and (b) a broadside-null radiating element (monopole). A broadside-null element places a blind spot in directions where it is undesirable to transmit or receive radar energy



FIGURE 6. An early L-band dipole phased-array test bed developed by the Sperry Rand Corporation, used in Lincoln Laboratory array investigations during the 1960s.

tenna for a space-based-radar surveillance system intended to detect and track aircraft, ships, armored vehicles, ballistic missiles, and cruise missiles [35]. As a part of this work, the Laboratory made major contributions to the analysis, design, calibration, and testing of space-based-radar antenna systems. A phased-array radar orbiting the earth must demonstrate a number of unique characteristics that require novel antenna technology if the radar is to satisfy mission needs. For example, radar clutter is very large when seen by a space-borne radar looking down at the earth. In addition, the radar satellite speed is very fast, and the Doppler shifts of the radar clutter echoes tend to mask the desired radar-target returns. Thus methods for canceling radar clutter, as viewed from space, are necessary. The radar also requires nulling of large ground-based jammers.

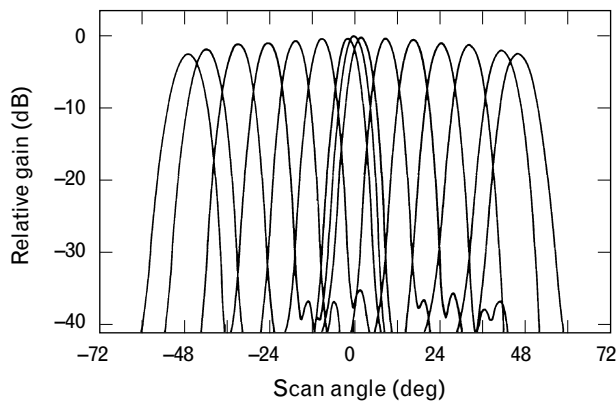

FIGURE 7. Low-sidelobe radiation patterns from the L-band Multiple-Antenna Surveillance Radar (MASR) waveguide phased-array antenna at midband. The beams are scanned to a maximum of $\pm 45^\circ$ in azimuth. Typically, the first sidelobe is at the -36 -dB to -38 -dB level, with the peaks of all others below -42 dB (except one shown). The achieved low-sidelobe levels represent the best performance at the time for electronically scanned array antennas.

System aspects of the Lincoln Laboratory–designed space-based radar are described in the previously mentioned article by Muehe and Labitt in this issue. The Laboratory’s low-altitude space-based-radar concept favored monopole-type radiators that had minimum radiation in the subsatellite (nadir) direction, to reduce radar clutter and jamming. Fenn investigated this problem both theoretically and experimentally for vertically polarized monopoles [20] and for horizontally polarized loops [21]. Figure 8 shows an L-band space-based-radar phased-array antenna test bed with 96 active monopole radiating elements (resembling a bed of nails). This displaced-phase-center array achieved a measured clutter

cancellation on the order of 40 dB, as shown in the graph in Figure 9.

A displaced-phase-center antenna designed for clutter cancellation normally turns off elements in order to shift the array phase center. Thus the phase center can be moved only in discrete columns or rows, dictated by the element spacing. For the space-based radar, a method utilizing an amplitude taper for moving the phase center an arbitrary distance (including a fraction of a column) was developed [36].

Low-sidelobe antenna patterns and adaptive nulling are useful in suppressing both jamming and radar clutter. An ultralow-sidelobe adaptive-array antenna at UHF called RSTER (Radar Surveillance Technology Experimental Radar) was developed by Westinghouse Corporation for Lincoln Laboratory, with average sidelobes in azimuth on the order of 60 dB below the main lobe (see the article entitled “Radars for the Detection and Tracking of Cruise Missiles,” by Lee O. Upton and Lewis A. Thurman, in this issue). This array used a corporate beamformer, with special care taken to reduce amplitude errors and phase-illumination errors across the array [37].

Phase Shifters

Lincoln Laboratory worked intensively in the late 1950s and in the 1960s to develop phase shifters for the electronic beam steering of phased-array radars desired in that time period. Many of the Laboratory development efforts in the area of phase shifters and related programs at that time are described in a book chapter by William J. Ince and Donald H. Temme [38].

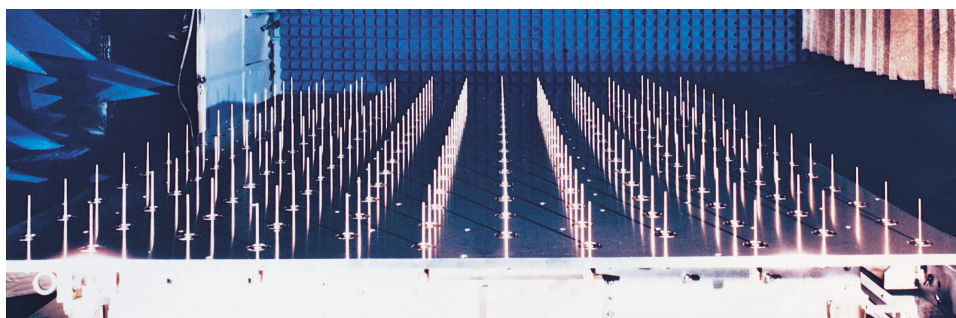

FIGURE 8. Displaced-phase-center monopole phased-array antenna test bed with 96 active monopole radiating elements. This L-band antenna was used for space-based-radar clutter-cancellation measurements.

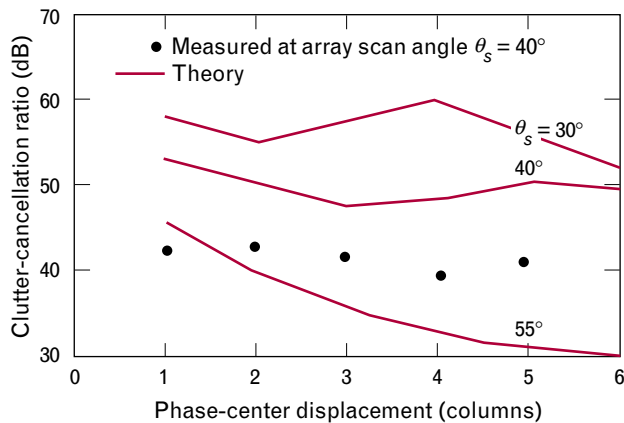

FIGURE 9. The displaced-phase-center antenna test-bed array shown in Figure 8 achieved a measured clutter-cancellation ratio on the order of 40 dB. The theoretical curves include only array mutual-coupling effects [80].

The first fielded phased-array radar, called ESAR (Electronically Scanned Array Radar), was built by Bendix and completed in 1960 [39]. ESAR had IF analog phase shifters and an IF beamformer. This beamforming technique was bulky and required good temperature control. One of the Laboratory's early initiatives in phased-array beam steering was the development of digital IF beam-steering techniques that emphasized smaller size and simplicity in control. This approach utilized diode-controlled digital phase shifters that switched in and out fractional wavelengths of transmission line arranged in a binary cascade and placed in each antenna channel to properly phase the elements of the radiating array.

These phase shifters, an example of which is shown in Figure 10, were tested in an experimental linear ar-

ray. They tended to have high loss (several dB) at microwave frequencies, which is certainly a drawback. Concurrently, new RF positive-intrinsic-negative (PIN) diodes used in microwave switching studies led to simpler lower-loss phase shifters. A. Uhler of Bell Telephone Laboratories had shown theoretically how the PIN diode would be ideal for microwave switches, with a low impedance when DC-forward-biased and a high impedance when DC-reverse-biased [38]. The DC-injected carriers in a PIN diode have long lifetimes compared to an RF period, but not for an IF period. Thus, for RF frequencies, the PIN diode does not rectify but has a low impedance when flooded with DC-injected carriers and a high impedance (becoming a small capacitor) without injected carriers.

Temme at Lincoln Laboratory used these PIN diodes to construct the first-ever digital-diode L-band low-loss phase shifter [5], which is shown in Figure 11. Low-loss diode phase shifters were implemented in several fielded phased-array radars used in missile detection, such as HAPDAR (Hard Point Demonstration Array Radar), AN/FPS-85, MSR (Missile Site Radar), Cobra Dane, and the S-band Cobra Judy [4, 39–41]. MSR used a different circuit configuration, which was devised by J.F. White [42] to achieve substantially higher RF power capabilities. When two equal shunt reactances are spaced a quarter-wavelength apart on a transmission line, a match remains and a phase shift is introduced. Each shunt reactance was connected and disconnected across the transmission line via a PIN-diode switch to obtain a small variable phase shift, but at a large power level. Sixteen pairs were used in the MSR phase shifter. The power

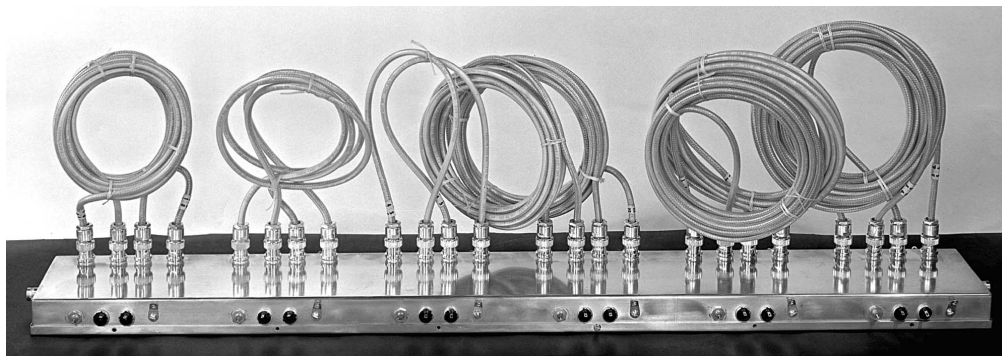

FIGURE 10. Early intermediate-frequency six-bit digital phase shifter. Each bit consists of a length of coaxial cable that can be switched into the signal path to produce the desired phase shift.

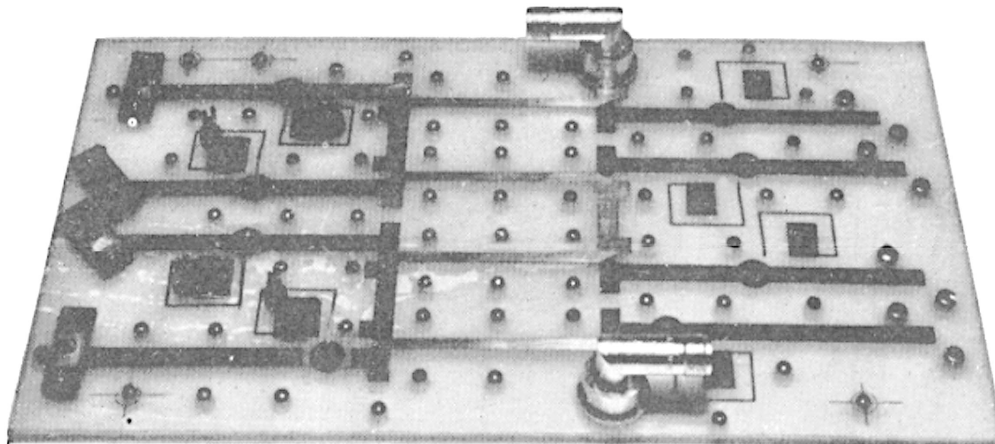

FIGURE 11. A four-bit low-loss hybrid L-band diode phase shifter. The stripline ground planes have been removed for clarity.

level, the bandwidth, and the RF loss are interrelated by the reactance and diode parameters.

The L-band HAPDAR phased-array radar [41] was built by Sperry and was completed in 1965. The UHF AN/FPS-85 [43] phased-array radar was built by Bendix and was completed in 1968. The S-band MSR was built by Raytheon and was completed in 1969. The L-band Cobra Dane phased-array radar, located in Shemya, Alaska, for observation of Soviet missile tests, was built by Raytheon and was completed in 1976. The article in this issue entitled “Wideband Radar for Ballistic Missile Defense and Range-Doppler Imaging of Satellites,” by William W. Camp et al., describes the Cobra Dane radar in more detail. Four UHF Position and Velocity Extraction (PAVE) Phased Array Warning System (PAWS) [44] phased-array radars (all solid state) were built by Raytheon, and are still used for missile warning and space surveillance.

Ferrite phase shifters, a development that started later than diode phase shifters, promised better performance than diode phase shifters (primarily lower microwave loss) at S-band and higher frequencies. Early discussions and analyses were done at the Laboratory, which contributed to the early microwave-ferrite development [45].

The ferrite phase shifter with a dielectric-loaded toroid was conceived and analyzed at the Laboratory. It was the first phase shifter with less than one dB insertion loss that could handle kilowatts of peak power

in the microwave region [46]. Figure 12 shows a photograph of a production model of this digital ferrite phase shifter. The development of improved ferrite materials was an important aspect of attaining the good performance promised by ferrite phase shifters. Understanding the mechanical stress on the ferrite toroid led to the development of ferrite material compositions with less stress sensitivity, as investigated by Ernest Stern, Temme, and Gerald F. Dionne [47–49].

A lower-cost ferrite material—lithium ferrite—developed by the Laboratory with the assistance of Ampex Corporation had less temperature sensitivity to the magnetization that directly controls the phase

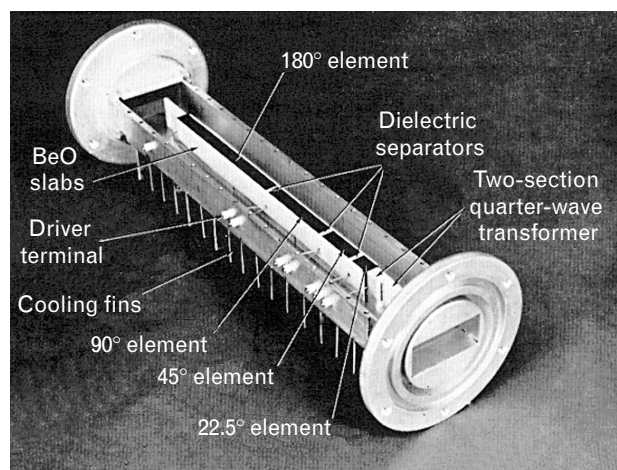

FIGURE 12. A Westinghouse production model of a four-bit C-band ferrite phase shifter, with the waveguide cover removed.

shift. The use of this material also permitted the extension of ferrite-phase-shifter operation to millimeter-wavelength frequencies [50]. A flux-drive technique, also developed by the Laboratory, enabled phase setting of phase shifters with low temperature sensitivity and five-bit accuracy without the penalty of complexity in the phase shifter and driver [51].

These ferrite-phase-shifter techniques were used in the S-band Aegis phased-array radar developed for the U.S. Navy by RCA in 1974, the C-band Patriot radar developed for the U.S. Army by Raytheon in 1975, and the X-band Joint Surveillance Target Attack Radar System (Joint STARS) developed for the U.S. Air Force by Grumman in 1988 [52]. Two prototypes of Joint STARS flew forty-nine missions in Operation Desert Storm in 1991; a Joint STARS radar surveillance image is shown in Figure 11 in the article by Muehe and Labitt in this issue.

Solid State Transmit/Receive Modules

From 1982 to 1990, Lincoln Laboratory led a joint U.S. Air Force/U.S. Navy space-based-radar trans-

mit/receive-module development program. The goals of this program were to utilize monolithic microwave integrated circuits (MMIC) and gallium-arsenide digital circuitry to produce low-weight, small-size, highly radiation resistant, highly efficient, and affordable modules that were capable of controlling signal phase accurately over the anticipated temperature range, with adequate RF-power generation, low DC-power consumption, and low-noise operation. Figure 13 illustrates the configuration of the L-band transmit/receive module. Both General Electric and Raytheon produced several versions of transmit/receive modules for this program; Figure 14 shows a General Electric module.

Lightweight L-band transmit/receive module technology developed for space-based radar applications was utilized in the Iridium commercial satellite communications system, which used phased-array antennas [53]. Gallium-arsenide MMIC transmit/receive-module technology is used in the Theater High-Altitude Area Defense (THAAD) X-band phased-array radar system [54] built by Raytheon Corporation.

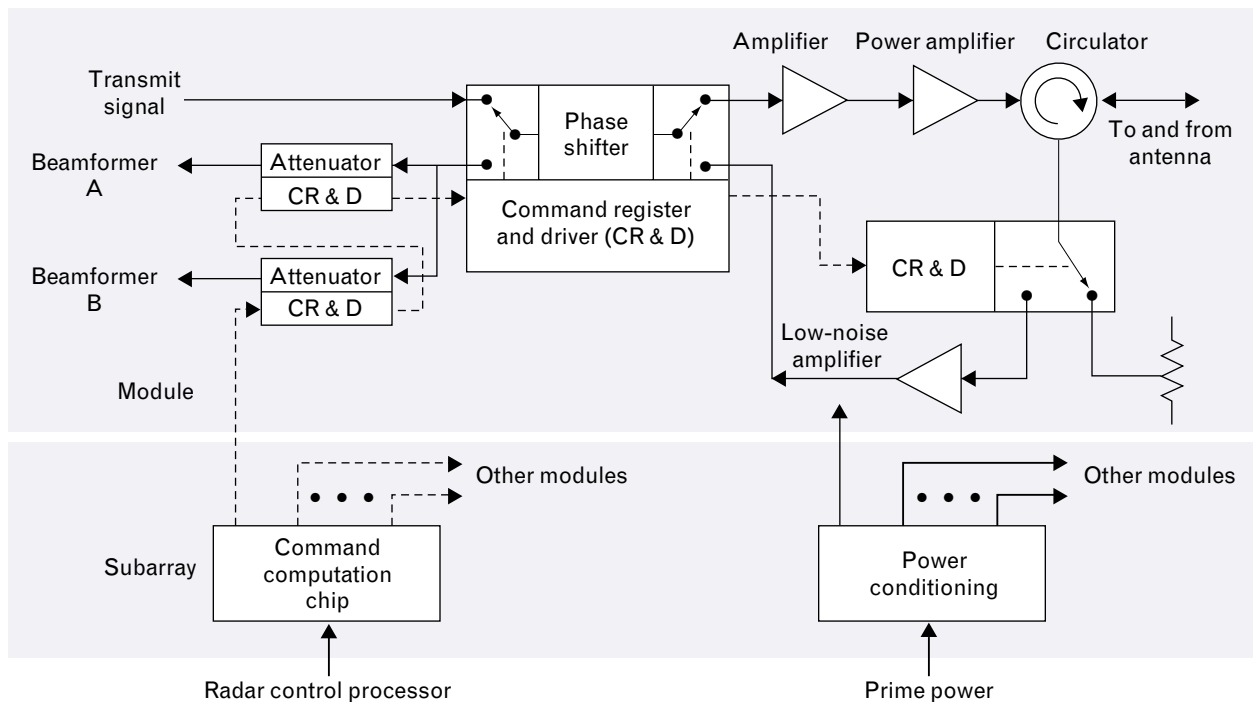

FIGURE 13. Diagram for desired L-band transmit/receive module for space-based-radar applications. The module contains switches that select either the transmit or receive paths. The receive path contains two attenuators to illuminate two displaced phase centers, represented by beamformers A and B. The transmit path contains a phase shifter and a power amplifier to achieve the desired transmit power level for the radar.

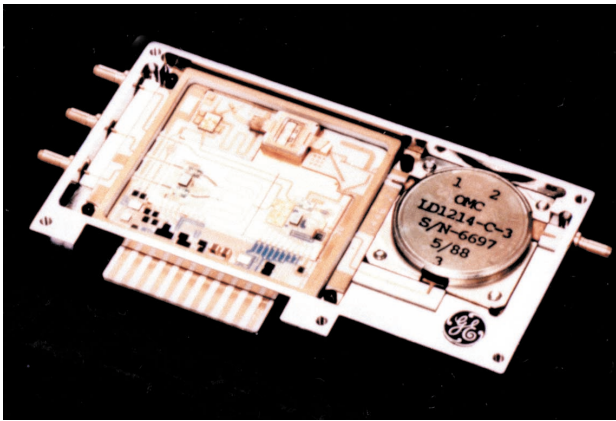

FIGURE 14. General Electric L-band transmit/receive module for space-based radar operations.

The Evolution of Solid State Active Elements for Phased-Array Antennas

The possibility of creating an all-solid-state realization of the phased-array concept arose in the late 1960s, notably through an initiative by Mel Vosburg of the Institute for Defense Analyses, a study and analysis center sponsored by the Department of Defense (DoD). Vosburg and Carl Blake of Lincoln Laboratory worked together in this venture. Blake had succeeded John Allen as leader of the Array Radars group in which the seminal work on phased-array theory and development had taken place during the previous decade, as described earlier in this article. With support from the U.S. Army's ballistic-missile-defense program at the Ballistic Missile Defense Advanced Technology Center (BMDATC) of Huntsville, Alabama, development of components with this phased-array objective was initiated at Lincoln Laboratory in the 1970s. The initial focus was on arrays in the L-band frequency range.

While the earlier generation of phased arrays had been based on phasers (variable phase shifters) in conductive-tube waveguides and centralized high-power vacuum tubes, developers envisioned that array designs incorporating solid state integrated circuits would open the array concept to a wide range of important applications, which would benefit from the major advantages of these circuits, especially compact size, low weight, low cost, and high reliability.

In the 1960s the technology required for mono-

lithic circuits had not yet sufficiently matured. The limited quality of early materials and the limitations of processing technology at the time led to poor production yields and inadequate performance of monolithic components. Hence the research effort was initially based on hybrid designs combining integrated circuits with more conventional components. Hybrid circuits were composed of discrete packaged transistors, diode phase-shifting circuits and switches, and passive components, all attached to a common ceramic substrate and connected to intervening planar circuits by means of wire bonds. Early development programs based on the hybrid-design concept, in the late 1960s and early 1970s, were performed primarily in industrial laboratories, including those at Texas Instruments, Raytheon, RCA, Westinghouse, General Electric, and Hughes. In particular, T. Hyltin of Texas Instruments, with the support of R. Albert and W. Edwards at Wright-Patterson Air Force Base in Ohio, initiated the Molecular Electronics for Radar Applications (MERA) program to build a solid state airborne radar.

In the late 1960s, under Blake's impetus, Lincoln Laboratory established a microwave integrated-circuit facility to develop and refine the technology of preparing substrates and applying circuits and devices, mainly in the hybrid mode, to the required specifications for microwave use. Planar circuits were fabricated, on steadily improving ceramic substrate materials—principally aluminum oxide—with the most refined photolithography materials and techniques then available. With these improvements, and with U.S. Army sponsorship of a program called CAMEL by the U.S. Army's Fort Monmouth, New Jersey, laboratory, researchers began developing a 100-element L-band (1.0 to 2.0 GHz) test array [55]. A second-generation development was the Advanced Fielded Array Radar (AFAR) at RCA in Moorestown, New Jersey, with modules produced by Westinghouse. Although AFAR was not carried to completion, the effort was valuable in demonstrating the promises and the limits of hybrid technology.

Gallium-Arsenide Monolithic Integrated Circuits

The all-solid-state UHF ground-based radar called PAVE PAWS was built with hybrid technology, and it

performed successfully. The designs of other military defense radars, such as the Reliable Advanced Solid State Radar (RASSR) and the Solid State Phased Array (SSPA) [56] sponsored by the U.S. Air Force, were based on similar solid-state hybrid technology. Eventually, however, researchers realized that a large-scale, solid-state phased-array radar made with hybrid circuits would require a very large number of discrete components and associated wire bonds, which would lead to excessive cost and inferior reliability compared to the promise of monolithic technology. Consequently, the phased-array research effort shifted toward the development and deployment of fully integrated circuits composed of devices created on a common semiconductor substrate [57].

The substrate material recognized as most promising was gallium arsenide, principally for its characteristically high carrier mobility, and thus its suitability for high-frequency systems, specifically in the microwave (1 to 30 GHz) and millimeter-wave (30 to 300 GHz) frequency ranges. The highest available frequencies, and accordingly the shortest wavelengths, are essential to form narrow beams for high resolution in target tracking, while lower frequencies, with better prospects to fulfill the requirement of high transmitter power, are favored for the associated functions of surveillance and search. In 1968, in an important development, E.W. Mehal and R.W. Wacker [58] and G.D. Vendelin et al. [59], all working at Texas Instruments, reported an early success in development of devices and circuits on gallium arsenide for microwave and millimeter-wave frequencies. Another significant advance in those years was a monolithic low-noise field-effect transistor (FET) microwave amplifier on gallium arsenide, reported by W. Bächtold et al. at the IBM laboratory in Zurich [60].

In Lincoln Laboratory, Blake and Roger W. Sudbury collaborated to advance support for the MMIC phased array. The Laboratory organized its effort for these projects by establishing a mutually complementary relationship between the Microelectronics group in the Solid State Research division, which contributed the development and refinement of materials along with device fabrication and testing, and the Experimental Systems group, which contributed the circuit designs for phased-array technology.

Success in these pioneering efforts depended on the solution of numerous interrelated problems. The potential advantages of higher microwave or millimeter-wave frequencies, suitable for the narrow-beam, high-resolution tracking function of radars, imposed stringent requirements on the quality of gallium-arsenide materials for monolithic wafers, as well as rigorous demands on the optics, metallurgy, and chemistry of the photolithography process.

The semi-insulating gallium-arsenide substrate on whose surface the epitaxial device layers are fabricated is advantageous for its electrically inert character, permitting low insertion loss and also low coupling loss between the closely spaced circuit components. This key dielectric property was confirmed in detailed measurements of complex permittivity of gallium arsenide in the range of 2.5 to 36.0 GHz by William E. Courtney at Lincoln Laboratory [61]. These measurements showed that, when well processed, the material is in fact free of the frequency-dependent loss characteristics that some researchers had feared. As device and circuit quality improved, still higher performance of the substrate was required for electrical isolation of the devices, envisioned as densely positioned on the semiconductor wafer, against interaction with each other. An early success in this effort, demonstrated at Lincoln Laboratory [62], was the process of passivation by means of proton bombardment, to create crystalline defects and thereby impart near-intrinsic-semiconductor properties. Later, a simpler and less costly isolating technique, which was widely adopted, involved heavy doping of the intervening areas of the substrate to reduce carrier lifetime.

The early efforts in device development at Texas Instruments led to both hybrid and monolithic circuits, including balanced mixers, Gunn-diode oscillators, and frequency multipliers for receiver applications at millimeter-wave frequencies. Following these basic advances, various research groups produced planar devices showing dramatically improved performance. Such advances at the Laboratory and in industry led to a surge of development, especially of gallium-arsenide metal-semiconductor field-effect transistors (MESFET), both in discrete form and as active devices on monolithic chips. The completely monolithic microwave amplifier chip with gallium-

arsenide MESFETs and matching circuits was first reported by R.S. Pengelly and J.A. Turner at Plessey Co. Ltd. in 1976 [63]; this achievement led to a rapid increase in the involvement of all the leading microwave research laboratories in further development of monolithic circuits.

A presentation by Courtney et al. in 1980 [64] characterized the problems and potential of a monolithic receiver, which is central to the concept of a solid-state phased array. The Laboratory took on an advisory role for government agencies that were supporting the new generation of phased-array design. At the same time the Laboratory continued to conduct its own research directed toward (1) the development of technology applicable to the transmit/receive module for array antennas in military systems, as well as (2) the enhancement of its own capability for innovation and consultation.

There was interest in Lincoln Laboratory's proposals for research in solid-state-circuit technology from the Very High-Speed Integrated Circuits (VHSIC) program under Sonny Maynard of the DoD. In the 1980s, major support for the development of monolithic microwave technology came through the efforts of Elliot Cohen, a DoD associate of Maynard's and a major advocate, with Blake, of investigation into practical uses of gallium arsenide for microwave integrated circuits. Cohen sponsored the Microwave and Millimeter Wave Monolithic Integrated Circuits (MIMIC) program [65] within the Defense Advanced Research Projects Agency (DARPA). The program was based on the concept of an "active element" phased array; i.e., an array with integrated-circuit phasers and transmit/receive capability as an integral part of each antenna element, locked to a central phase and amplitude standard.

The MIMIC program maintained the impetus of the earlier developments and encouraged the microwave industry to construct the large gallium-arsenide processing facilities that exist today for the fabrication of phased-array and telecommunication modules. The MIMIC program's objectives included development of volume production technology to produce large-diameter, high-quality substrates suitable for commercial production of MESFETs optimized for high power or for low noise; development of com-

puter-aided device and circuit design programs (a powerful discipline then still in its infancy); and proof of feasibility to show that monolithic circuits can find applications in circuits that are suitable and affordable for wide use in military systems.

Lincoln Laboratory became deeply involved in this developing technology, supported by BMDATC. It was proposed that the Laboratory continue to serve in its advisory role to the government agencies that were funding various aspects of the new technologies, while at the same time enhancing the Laboratory's own expertise in the area by developing the technology for a millimeter-wave transmit/receive module—specifically, for a K_a -band (26.5 to 40 GHz) phased-array seeker on a missile.

The K_a -band module proposed for development at Lincoln Laboratory under the MIMIC program was a single-polarization transmit/receive module with average output power on the order of 100 mW in the millimeter-wave range at 34 GHz. The system considerations for such a radar and component development to that date were reviewed in 1978 by R.W. Laton et al. [66] and by Sudbury [67] at Lincoln Laboratory. Figure 15 illustrates the K_a -band transmit/receive-module configuration and includes illustrations of the component chips as of 1985 [68, 57]. The receiver section was based on planar Schottky-barrier diodes in a balanced-mixer/heterodyne configuration [69]. A novel approach in this circuit was the dual use of the mixer: in receive mode to produce an L-band IF signal, and as a switch to protect the receiver in transmit mode [70]. The mixer output was followed by a two-stage low-noise IF amplifier, developed at Lincoln Laboratory, which used a very low-loss planar coupling capacitor fabricated with high-dielectric tantalum pentoxide [71].

In addition to fabricating the dual-function mixer shown in Figure 15, the Laboratory also fabricated a mixer-preamplifier monolithic chip, successfully combining for the first time two different active microwave devices on the same chip. These devices were a millimeter-wave Schottky-diode mixer followed by a MESFET IF amplifier operating at 1.0 to 2.0 GHz. The transmitter chain incorporated a 17-GHz MESFET driver amplifier, a low-loss phaser using Schottky diodes, and a 17-GHz FET power amplifier

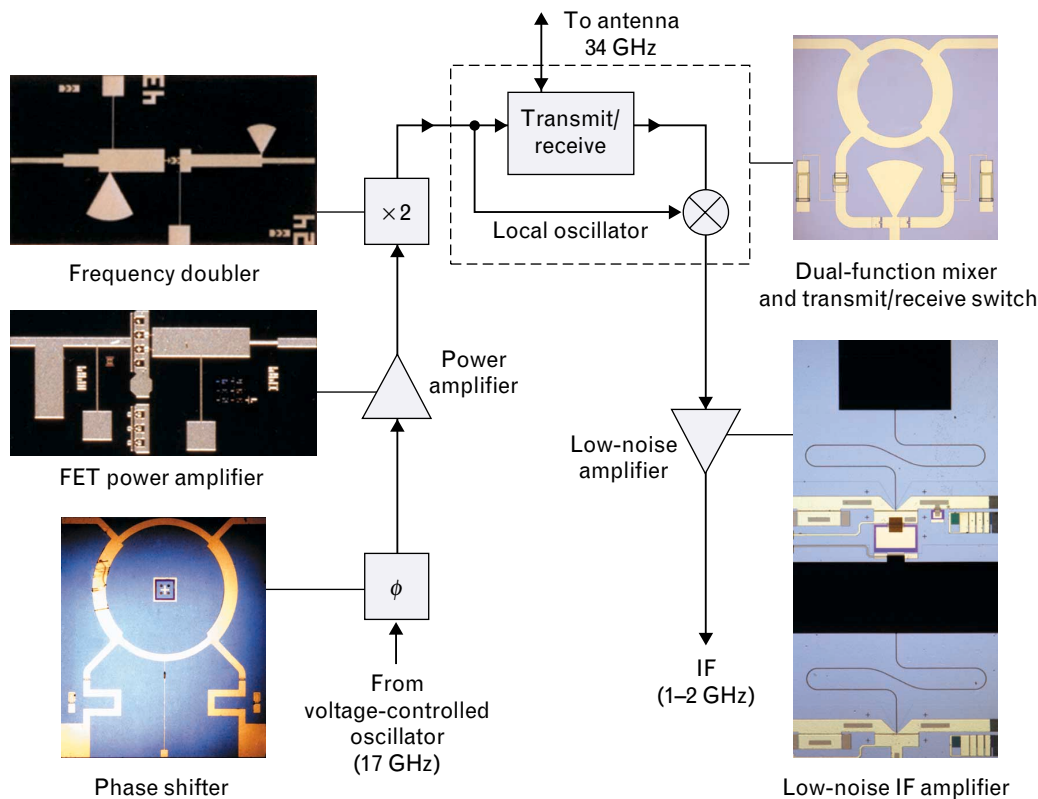

FIGURE 15. Module configuration and organization of component chips for a gallium-arsenide active-element transmit/receive circuit. The transmit side includes phase control and field-effect transistor (FET) power amplification at 17 GHz, and a frequency doubler. On the receive side, a dual unit incorporates a transmit/receive switch and a mixer that produces the intermediate frequency (IF) at 1 to 2 GHz. This dual unit is followed by a low-noise output amplifier.

driving a doubler to produce output power at 34 GHz [72]. The monolithic doublers [73] were planar series-connected varactor diodes embedded in matching circuits on a chip. They produced output greater than 100 milliwatts with 35% efficiency at K_u -band frequencies [74]. The strategy of frequency doubling from 17 GHz (K_u band, 12.0 to 18.0 GHz) to 34 GHz (K_a band) was devised, because in the late 1970s and early 1980s the cutoff frequency of the MESFET amplifiers was not sufficiently high for operation at millimeter-wave frequencies.

By 1990, active solid state devices at microwave frequencies were becoming ubiquitous; MMICs were routinely developed for commercial applications such as automobile instrumentation and civilian communications, and active transmit/receive modules were being utilized for large phased arrays. Gallium-arsenide MMIC transmit/receive-module technology is used in the X-band (8.0 to 12.0 GHz) theater-mis-

sile-defense phased-array radar system [54] built by Raytheon Corporation. The decade of the 1990s saw widespread application of gallium-arsenide monolithic integrated circuits in many fields, including radar, the Global Positioning System (GPS), direct-satellite-broadcast receivers, and commercial wireless telephony.

Array Calibration and Testing

Phased-array antennas require accurate calibration of their multiplicity of transmit/receive channels, so that the radar main beam can be pointed in the correct direction and the sidelobe levels of the radar antenna can be controlled. In practice, the phase shift through a channel is often affected by temperature and electronic drift; thus methods for calibration of a fielded radar system are required. Lincoln Laboratory has pioneered several phased-array calibration and radiation-pattern measurement techniques [75–80].

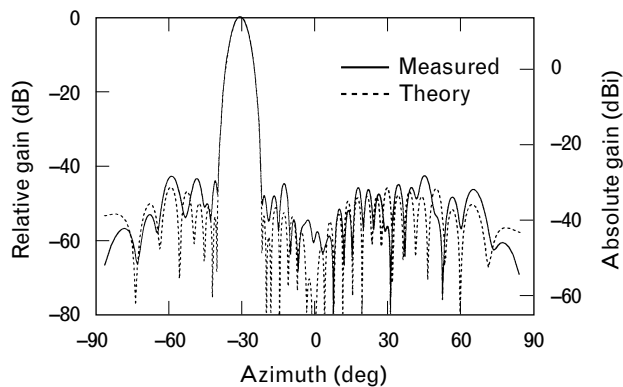

FIGURE 16. Low-sidelobe radiation patterns for an L-band thirty-two-element monopole phased-array antenna. The average measured sidelobe level is -50 dB, which is close to the average theoretical sidelobe level of -52.6 dB.

Airborne and space-based phased arrays containing thousands of transmit/receive channels require onboard techniques for in-flight calibration. One such calibration technique involved the use of the inherent array mutual coupling to transmit and receive signals between pairs of elements in the array, as described in a paper by H.M. Aumann et al. (this paper won the 1990 IEEE Antennas and Propagation Society's Best Applications Award) [75]. The measured signals between all pairs of elements in the array allow a complete characterization of the relative amplitude and phase response of each channel in the array beamformer. Thus the channel phase shifters and attenuators (illustrated in Figure 13) can be calibrated to generate any desired phase/amplitude distribution across the aperture of the array. Furthermore, it was discovered that once the desired phase and amplitude distributions had been applied to the array, a second series of mutual-coupling measurements allowed a measurement of the phased-array radiation patterns. The mutual-coupling calibration technique was experimentally verified by using the monopole phased-array antenna shown in Figure 8. This calibration technique proved to be a fast and accurate way of measuring one-dimensional and two-dimensional array radiation patterns, compared to conventional far-field measurement techniques.

The Laboratory explored various other approaches for calibrating and testing low-sidelobe phased arrays. For example, adaptive-nulling techniques were used

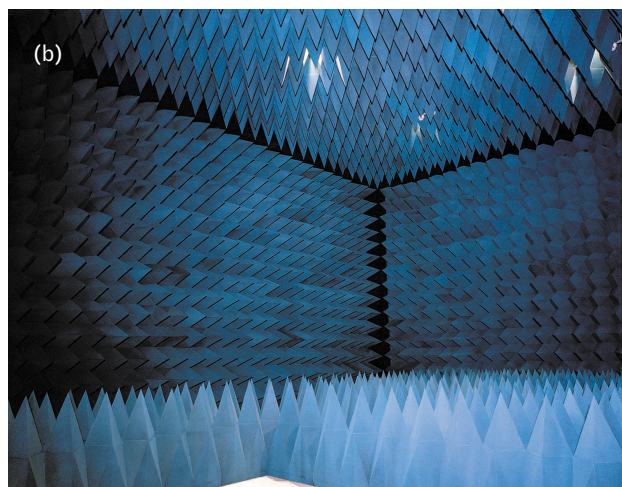

FIGURE 17. (a) Lincoln Laboratory's ground-test facility for adaptive phased-array antenna evaluation in space-based-radar applications. (b) This facility has interior walls covered with radiation-absorbing material, which enables full-scale real-time testing of radar capability at a test distance of approximately one aperture diameter.

to calibrate an experimental test array [76]. Methods for compensating for the effects of variations in the array radiating-element patterns [77] and failed radiating elements [78] were also developed. The Laboratory also explored planar near-field calibration and testing in the antenna reactive region (extremely close near field) to accurately measure low-sidelobe radiation patterns [79]. Figure 16 shows a typical low-sidelobe monopole phased-array radiation pattern measured with the reactive-region near-field-scanning approach. The measured average sidelobe level is -50 dB, close to the theoretical value. Space-based radars or airborne radars can use multiple displaced phase centers to cancel clutter, as described in the article by Muehe and Labitt in this issue. A near-field

scanning method for measuring the clutter-cancellation performance of displaced-phase-center antennas was also demonstrated [80].

The above phased-array testing techniques are generally restricted to non-real-time operation. There are many instances, however, when it is desirable to test a radar system, either in the field or prior to deployment, under simulated real-time conditions that include radar targets, clutter, and jamming. Some of these radars can have large apertures, on the order of five to twenty meters. Normally, radars operate under far-field conditions in which the radiated wavefront is approximately planar. Because testing these radar antennas under far-field conditions can require a range several miles long, alternative shorter-range testing is desirable. A near-field ground-test facility for phased-array antenna evaluation in space-based radar applications was developed by Lincoln Laboratory [81]. This facility, which consists of a large building with the interior walls covered with radiation-absorbing material, enables full-scale real-time testing of phased-array radar capability at a test distance of approximately one aperture diameter. The test facility, shown in Figure 17, provides the capability of implementing a number of novel test procedures developed by the Laboratory for measuring the radar system performance for antennas up to about twelve meters in length.

A focused near-field method to test the real-time performance of adaptive phased arrays for jammer suppression was theoretically analyzed for single-phase-center antennas [82] and multiple-phase-center antennas for clutter and jammer suppression and target detection [83]. The focused near-field nulling technique for suppressing jammers was experimentally verified for a single-phase-center array antenna [84]. The focused near-field adaptive-nulling testing technique was also found to have a medical application as well [85].

Summary

The 1950s dream of electronic beam steering is gradually being realized by a variety of phased arrays currently being used in many ground-based and airborne radars. Phased arrays are increasingly envisioned to be critical components for meeting future

challenges in military and civilian systems. Since 1958 the Laboratory has contributed significantly to the nation's phased-array radar capabilities. Technologies developed at the Laboratory have been implemented in many phased-array radars in field operations. The Laboratory is continuing to investigate new phased-array technologies in such areas as photonic beamforming, micro-electromechanical phase shifters, and advanced space-time adaptive processing arrays.

We foresee great promise in the combination of the technologies of low-cost all-solid-state array modules, wide-bandwidth analog-to-digital converters, and adaptive digital beamforming to allow a variety of sophisticated radar operating modes and radar systems.

During the past forty years, Lincoln Laboratory was privileged to work in this most interesting area of radar technology and be part of the extensive national effort to make the vision of electronic beam steering become a reality [1]. We can posit that the era of the phased-array radar is just beginning!

Acknowledgments

The authors would like to acknowledge Jerald A. Weiss and Roger W. Sudbury of Lincoln Laboratory for their technical contributions to this article. We also acknowledge George Knittel and John Allen for their review of the manuscript, and Chang-Lee Chen, Leonard J. Mahoney, and Anand Gopinath for furnishing material for the manuscript.

REFERENCES

1. C.A. Fowler, "Old Radar Types Never Die; They Just Phased Array, or 55 Years of Trying to Avoid Mechanical Scan," *IEEE Aerosp. Electron. Syst. Mag.* 13 (9), 1998, pp. 24A-24L.
2. Private communication.
3. Private communication.
4. J.L. Allen, L. Cartledge, W.P. Delaney, and J. Dibartolo, "Phased Array Radar Studies, 1 July 1960 to 1 July 1961," *Technical Report 236*, Lincoln Laboratory (13 Nov. 1961), DTIC #AD-271724.
5. J.L. Allen, D.M. Bernella, W.W. Carpenter, and W.P. Delaney, "Phased Array Radar Studies, 1 July 1961 to 1 July 1963," *Technical Report 299*, Lincoln Laboratory (20 Feb. 1963), DTIC #AD-417572.
6. J.L. Allen, D.M. Bernella, F. Betts, and L. Cartledge, "Phased Array Radar Studies, 1 July 1963 to 1 July 1964," *Technical Report 381*, Lincoln Laboratory (31 Mar. 1965), DTIC #AD-629363.

7. J. Butler, "Multiple Beam Antenna," Internal Memorandum RF-3849, Sanders Associates, Inc., Nashua, N.H., 8 Jan. 1960.
8. J. Butler and R. Lowe, "Beam-Forming Matrix Simplifies Design of Electronically Scanned Antennas," *Electron. Des.* **9**, 12 Apr. 1961, pp. 170–173.
9. J.L. Allen, "A Theoretical Limitation on the Formation of Lossless Multiple Beams in Linear Arrays," *IRE Trans. Antennas Propag.* **9** (4), 1961, pp. 350–352.
10. W.P. Delaney, "An RF Multiple Beam Forming Technique," *Group Report 41G-0012*, Lincoln Laboratory (9 Aug. 1961), DTIC #AD-262017.
11. A.A. Oliner and G.H. Knittel, eds., *Phased Array Antennas* (Artech House, Dedham, Mass., 1972).
12. J.L. Allen, "Theory of Array Antennas (with Emphasis on Radar Applications)," *Technical Report 323*, Lincoln Laboratory (25 July 1963), DTIC #AD-422945.
13. B.L. Diamond, "A Generalized Approach to the Analysis of Infinite Planar Phased Array Antennas," *Proc. IEEE* **56** (11), 1968, pp. 1837–1851.
14. B.L. Diamond and G.H. Knittel, "A New Procedure for the Design of a Waveguide Element for a Phased-Array Antenna," in *Phased Array Antennas*, pp. 149–156.
15. G.N. Tsandoulas, "Unidimensionally Scanned Phased Arrays," *IEEE Trans. Antennas Propag.* **28** (1), 1980, pp. 86–99.
16. M.H. Chen, G.N. Tsandoulas, and E.G. Willwerth, "Modal Characteristics of Quadruple-Ridged Circular and Square Waveguides," *IEEE Trans. Microw. Theory Tech.* **22** (8), 1974, pp. 801–804.
17. M.H. Chen and G.N. Tsandoulas, "A Wide-Band Square-Waveguide Array Polarizer," *IEEE Trans. Antennas Propag.* **21** (3), 1973, pp. 389–391.
18. G.N. Tsandoulas, "Wideband Limitations of Waveguide Arrays," *Microw. J.* **15** (9), 1972, pp. 49–56.
19. G.N. Tsandoulas and G.H. Knittel, "The Analysis and Design of Dual-Polarization Square-Waveguide Phased Arrays," *IEEE Trans. Antennas Propag.* **21** (6), 1973, pp. 796–808.
20. A.J. Fenn, "Theoretical and Experimental Study of Monopole Phased Array Antennas," *IEEE Trans. Antennas Propag.* **34** (10), 1985, pp. 1118–1126.
21. A.J. Fenn, "Arrays of Horizontally Polarized Loop-Fed Slotted Cylinder Antennas," *IEEE Trans. Antennas Propag.* **33** (4), 1985, pp. 375–382.
22. R.C. Hansen, ed., *Significant Phased Array Papers* (Artech House, Dedham, Mass., 1973).
23. R.J. Mailloux, *Phased Array Handbook* (Artech House, Dedham, Mass., 1994).
24. E. Brookner, ed., *Practical Phased-Array Antenna Systems* (Artech House, Boston, Mass., 1991).
25. R.C. Hansen, *Microwave Scanning Antennas, Vol. II: Array Theory and Practice* (Peninsula Publishing, Los Altos, Calif., 1985).
26. G.H. Knittel, "Relation of Radar Range Resolution and Signal-to-Noise Ratio to Phased-Array Bandwidth," *IEEE Trans. Antennas Propag.* **22** (3), 1974, pp. 418–426.
27. J.L. Allen, "Gain and Impedance Variation in Scanned Dipole Arrays," *IRE Trans. Antennas Propag.* **10** (5), 1962, pp. 566–572.
28. J.L. Allen and W.P. Delaney, "On the Effect of Mutual Coupling on Unequally Spaced Dipole Arrays," *IRE Trans. Antennas Propag.* **10** (6), 1962, pp. 784–785.
29. J.L. Allen, "On Array Element Impedance Variation with Spacing," *IRE Trans. Antennas Propag.* **12** (3), 1964, pp. 371–372.
30. J.L. Allen, "On Surface-Wave Coupling between Elements of Large Arrays," *IEEE Trans. Antennas Propag.* **13** (4), 1965, pp. 638–639.
31. J.L. Allen and B.L. Diamond, "Mutual Coupling in Array Antennas," *Technical Report 424*, Lincoln Laboratory (4 Oct. 1966), DTIC #AD-648153.
32. J.L. Allen, "A Simple Model for Mutual Coupling Effects on Patterns of Unequally Spaced Arrays," *IEEE Trans. Antennas Propag.* **15** (4), 1967, pp. 530–533.
33. B.L. Diamond, "Small Arrays—Their Analysis and Their Use for the Design of Array Elements," in *Phased Array Antennas*, pp. 127–131.
34. E. Brookner, ed., *Radar Technology* (Artech House, Dedham, Mass., 1991).
35. G.N. Tsandoulas, "Space-Based Radar," *Science* **237**, 17 July 1987, pp. 257–262.
36. H.M. Aumann, "Continuously Adjustable Phase Center Displacement in Phased Array Antennas," *1992 IEEE Antennas and Propagation Soc. Int. Symp. Digest 1, Chicago, 20–24 July 1992*, pp. 454–457.
37. B.D. Carlson, L.M. Goodman, J. Austin, M.W. Ganz, and L.O. Upton, "An Ultralow-Sidelobe Adaptive Array Antenna," *Linc. Lab. J.* **3** (2), 1990, pp. 291–309.
38. W.J. Ince and D.H. Temme, "Phasers and Time Delay Elements" in *Advances in Microwaves 4*, L. Young, ed. (Academic Press, New York, 1969), pp. 2–182.
39. M.I. Skolnik, "Nonuniform Arrays," in *Antenna Theory*, pt. 1, R.E. Collin and F.J. Zaker, eds. (McGraw-Hill, New York, 1969), pp. 207–234.
40. A. Uhlir, Jr., "The Potential of Semiconductor Diodes in High-Frequency Communications," *Proc. IRE* **46**, June 1948, pp. 1099–1115.
41. P.J. Kahrilas, "HAPDAR—An Operational Phased Array Radar," *Proc. IEEE* **56** (11), 1968, pp. 1967–1975.
42. J.F. White, "High Power, *p-i-n* Controlled, Microwave Transmission Phase Shifters," *IEEE Trans. Microw. Theory Tech.* **13** (2), 1965, pp. 233–242.
43. J.E. Reed, "The AN/FPS-85 Radar System," *Proc. IEEE* **57** (3), 1969, pp. 324–335.
44. E. Brookner, "Phased-Array Radars," *Sci. Am.* **252** (2), 1985, pp. 94–102.
45. B. Lax and K.J. Button, *Microwave Ferrites and Ferrimagnetics* (McGraw-Hill, New York, 1962).
46. W.J. Ince and E. Stern, "Computer Analysis of Ferrite Digital Phase Shifters," *IEEE Int. Convention Record 14, pt. 5, New York, 21–25 Mar. 1966*, pp. 32–38.
47. E. Stern and D.H. Temme, "Magnetostriction Effects in Remanence Phase Shifters," *IEEE Trans. Microw. Theory Tech.* **13** (6), 1965, pp. 873–874.
48. G.F. Dionne, "Effect of External Stress on Remanence Ratios and Anisotropy Fields of Magnetic Materials," *IEEE Trans. Magn.* **5** (3), 1969, pp. 596–600.
49. G.F. Dionne, P.J. Paul, and R.G. West, "Compensation of Magnetostriction Effects in Iron Garnets by Manganese Additions," *J. Appl. Phys.* **41** (3), 1970, p. 1411.
50. P.D. Baba, G.M. Argentina, W.E. Courtney, G.F. Dionne, and D.H. Temme, "Fabrication and Properties of Microwave Lithium Ferrites," *IEEE Trans. Magn.* **8** (1), 1972, pp. 83–94.
51. J. DiBartolo, W.J. Ince, and D.H. Temme, "A Solid-State 'Flux Drive' Control Circuit for Latching-Ferrite-Phaser Applications," *Microw. J.* **15** (9), 1972, pp. 59–64.
52. H. Shnitkin, "A Unique Joint STARS Phased-Array Antenna," *Microw. J.* **34** (1), 1991, pp. 131–141.
53. J.J. Schuss, J. Upton, B. Myers, T. Sikina, A. Rohwer, P. Makridakas, R. Francois, L. Wardle, W. Kreutel, and R. Smith,

- "The IRIDIUM[®] Main Mission Antenna Concept," *1996 IEEE Int. Symp. on Phased Array Systems and Technology, 15–18 Oct. 1996, Boston*, pp. 411–415.
54. M. Sarcione, J. Mulcahey, D. Schmidt, K. Chang, M. Russel, R. Enzmann, P. Rawlinson, W. Guzak, R. Howard, and M. Mitchell, "The Design, Development and Testing of the THAAD (Theater High Altitude Area Defense) Solid State Phased Array (Formerly Ground Based Radar)," *Proc. 1996 IEEE Int. Symp. on Phased Array Systems and Technology, Boston, 15–18 Oct. 1996*, pp. 260–265.
55. R. Sudbury, K. Fischer, E. Palmer, and G. Jones, "Operation of Solid-State Transceivers in an L-Band Array," *IEEE MTT/S Int. Microwave Symp. Dig., Atlanta, 12–14 June 1974*, pp. 65–67.
56. D.N. McQuiddy, Jr., R.L. Gassner, P. Hull, J.S. Mason, and J.M. Bedinger, "Transmit/Receive Module Technology for X-Band Active Array Radar," *Proc. IEEE* **79** (3), 1991, pp. 308–341.
57. A. Chu, W.E. Courtney, L.J. Mahoney, and B.J. Clifton, "Millimeter-Wave Monolithic Circuits for Receiver and Transmitter Applications," *RCA Review* **46** (4), 1985, pp. 421–430; *Conf. Rec. Electro/85 and Mini/Micro Northeast, New York, 23–25 Apr. 1985*, pp. 1–5.
58. E.W. Mehal and R.W. Wacker, "GaAs Integrated Microwave Circuits," *IEEE Trans. Electron Devices* **15** (7), 1968, pp. 513–516.
59. S. Mao, S. Jones, and G.D. Vendelin, "Millimeter-Wave Integrated Circuits," *IEEE Trans. Electron Devices* **15** (7), 1968, pp. 517–523.
60. W. Bächtold, W. Walter, and P. Wolf, "X and K_u Band M.E.S.F.E.T.," *Electron. Lett.* (UK) **8** (2), 1972, pp. 35–37.
61. W.E. Courtney, "Complex Permittivity of GaAs and CdTe at Microwave Frequencies," *IEEE Trans. Microw. Theory Tech.* **25** (8), 1977, pp. 697–701.
62. A.G. Foyt, W.T. Lindley, C.M. Wolfe, and J.P. Donnelly, "Isolation of Junction Devices in GaAs Using Proton Bombardment," *Solid-State Electron.* **12** (4), 1969, pp. 209–214.
63. R.S. Pengelly and J.A. Turner, "Monolithic Broadband GaAs F.E.T. Amplifiers," *Electron. Lett.* **12** (10), 1976, pp. 251–252.
64. Private communication.
65. E.D. Cohen, "Military Applications of MIMICs," *IEEE Microwave and Millimeter-Wave Monolithic Circuits Symp., Boston, 10–11 June 1999*, pp. 31–34.
66. Private communication.
67. R.W. Sudbury, "Monolithic GaAs Circuits for Millimeter-Wave Radar Applications," *Proc. Military Microwaves '80, London, 22–24 Oct. 1980*, pp. 223–227.
68. Private communication.
69. A. Chu, W.E. Courtney, G.A. Lincoln, L.J. Mahoney, and R.W. Sudbury, "GaAs Monolithic Balanced Mixer and Monolithic MESFET Amplifier for 32 GHz Receiver Application," *Workshop on Compound Semiconductors for Microwave Materials and Devices, San Francisco, 11–12 Feb. 1980*.
70. A. Chu, W.E. Courtney, L.J. Manfra, and A.R. Calawa, "Dual Function Mixer Circuit for Millimeter Wave Transceiver Applications," *IEEE MTT/S Int. Microwave Symp. Dig., St. Louis, Mo., 4–6 June 1985*, pp. 120–123; *Microw. J.* **28** (8), 1985, pp. 141–145. (Note: includes graphs of conversion loss and noise figure versus frequency, and ten references, including four of Chu et al.)
71. M.E. Elta, A. Chu, L.J. Mahoney, R.T. Cerretani, and W.E. Courtney, "Tantalum Oxide Capacitors for GaAs Monolithic Integrated Circuits," *IEEE Electron Device Lett.* **3** (5), 1982, pp. 127–129.
72. A. Chu, W.E. Courtney, C.L. Chen, L.J. Mahoney, M.J. Manfra, and H.A. Atwater, "Monolithic Analog Phase Shifters and Frequency Multipliers for mm-Wave Phased Array Applications," *Microw. J.* **29** (12), 1986, pp. 105–119.
73. A. Chu, W.E. Courtney, L.J. Mahoney, R.W. McLelland, and H.A. Atwater, "GaAs Monolithic Frequency Doublers with Series Connected Varactor Diodes," *IEEE Microwave and Millimeter-Wave Monolithic Circuits Symp. Dig., San Francisco, 29–30 May 1984*, pp. 74–78.
74. A. Chu, W.E. Courtney, L.J. Mahoney, R.W. McLelland, and H.A. Atwater, "GaAs Monolithic Frequency Doublers with Series Connected Diodes," *IEEE Microwave and Millimeter-Wave Monolithic Circuits Symp. Digest, San Francisco, 29–30 May 1984*, pp. 51–54.
75. H.M. Aumann, A.J. Fenn, and F.G. Willwerth, "Phased Array Antenna Calibration and Pattern Prediction Using Mutual Coupling Measurements," *IEEE Trans. Antennas Propag.* **37** (7), 1989, pp. 844–850.
76. H.M. Aumann and F.G. Willwerth, "Phased-Array Calibration by Adaptive Nulling," *Technical Report 915, Lincoln Laboratory (20 May 1991), ESD-TR-91-047, DTIC #ADA-238562*.
77. H.M. Aumann and F.G. Willwerth, "Phased Array Calibrations Using Measured Element Patterns," *1995 IEEE Antennas and Propagation Soc. Int. Symp. Digest 2, Newport Beach, Calif., 18–23 June 1995*, pp. 918–921.
78. H.M. Aumann and F.G. Willwerth, "Application of Beam-space Techniques to Phased Array Calibration and Fault Compensation," *1991 Antenna Measurement Techniques Assoc. Symp., Boulder, Colo., 7–11 Oct. 1991*, pp. 10B/9–13.
79. A.J. Fenn, H.M. Aumann, and F.G. Willwerth, "Linear Array Characteristics with One-Dimensional Reactive-Region Near-Field Scanning: Simulations and Measurements," *IEEE Trans. Antennas Propag.* **39** (9), 1991, pp. 1305–1311.
80. A.J. Fenn, F.G. Willwerth, and H.M. Aumann, "Displaced Phase Center Antenna Near Field Measurements for Space Based Radar Applications," *Phased Arrays 1985 Symp. Proc., 15–18 Oct. 1985, RADC-TR-85-171*, pp. 303–318, Aug. 1985, DTIC #ADA-169316.
81. G.N. Tsandoulas, "Space-Based Radar Antenna Test Bed," *Conf. Proc.: Military Microwaves '88, 5–7 July 1988, London*, pp. 225–230.
82. A.J. Fenn, "Evaluation of Adaptive Phased Array Antenna Far-Field Nulling Performance in the Near-Field Region," *IEEE Trans. Antennas Propag.* **38** (2), 1990, pp. 173–185.
83. A.J. Fenn, "Analysis of Phase-Focused Near-Field Testing for Multiphase-Center Adaptive Radar Systems," *IEEE Trans. Antennas and Propag.* **40** (8), 1992, pp. 878–887.
84. A.J. Fenn, H.M. Aumann, F.G. Willwerth, and J.R. Johnson, "Focused Near-Field Adaptive Nulling: Experimental Investigation," *1990 IEEE Antennas and Propagation Soc. Int. Symp. Digest 1, Dallas, 7–11 May 1990*, pp. 186–189.
85. A.J. Fenn and G.A. King, "Adaptive Nulling in the Hyperthermia Treatment of Cancer," *Linc. Lab. J.* **5** (2), 1992, pp. 223–240.



ALAN J. FENN

is a senior staff member in the Advanced Electromagnetic Systems group. He joined Lincoln Laboratory in 1981 and was a member of the Space Radar Technology group from 1982 to 1991, where his research was in phased-array antenna design, adaptive-array near-field testing, and antenna and radar cross-section measurements. From 1992 to 1999 he was an assistant group leader in the RF Technology group, where he managed programs involving optically controlled phased-array antennas and the measurement of atmospheric effects on radomes and satellite communications. In 2000 he was elected a Fellow of the IEEE for his contributions to the theory and practice of adaptive phased-array antennas. In 1990 he was a corecipient of the IEEE Antennas and Propagation Society's H.A. Wheeler Applications Prize Paper Award for a paper he coauthored for the *IEEE Transactions on Antennas and Propagation*. He also received the IEEE/URSI-sponsored 1994 International Symposium on Antennas (JINA 94) Award for the best poster presentation. He has a B.S. degree from the University of Illinois in Chicago, and M.S. and Ph.D. degrees from Ohio State University, Columbus, all in electrical engineering.

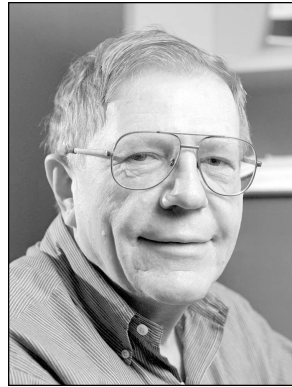

DONALD H. TEMME

is a former senior staff member in the Communications division, and at present a consultant to the Analog Device Technology group. His current research interest is in ferrite-superconductor control devices. Some of the major Laboratory programs he contributed to were early phase-shifter developments, tactical air-surveillance radar (HOWLS), millimeter homing radar, and space-borne surveillance radar. He is currently assisting the Concord Middle School in increasing the physics content of the basic science course. He received a B.S. degree in electrical engineering from the University of Nebraska, and an S.M. degree in electrical engineering from MIT. Before joining Lincoln Laboratory in 1957 he was in the U.S. Air Force. He is a life member of the IEEE and a member of Sigma Xi.



WILLIAM P. DELANEY

came to Lincoln Laboratory in 1957 after receiving a B.E.E. degree from Rensselaer Polytechnic Institute. In 1959 he received an S.M.E.E. degree from MIT, where he became involved in radar with a thesis on UHF power amplifiers for phased arrays. His early research at the Laboratory involved phased-array radars. At Kwajalein Atoll he led the ALCOR wideband radar project. Returning to the Laboratory in 1970, he held management positions of increasing responsibility in missile defense, air defense, air traffic control, and battlefield surveillance, all involving radar systems. From 1973 to 1976 he served in the Office of the Secretary of Defense, with responsibilities for R&D in strategic defense systems. In 1987 he was appointed assistant director of the Laboratory, and in 1995 he became a Director's Office Fellow. He has served on many government committees, including the Air Force Scientific Advisory Board and the Defense Science Board. He has been awarded the Secretary of Defense Meritorious Civilian Service Medal and the Air Force Exceptional Civilian Service Medal. In 1991 he was elected a Fellow of the IEEE. His dominant recreational pursuit is fly fishing, including far-flung places such as Christmas Island, Patagonia, or the Kola Peninsula of Russia, where he catches fish so large he doesn't have to lie about them!



WILLIAM E. COURTNEY

was born in Lurgan County, Armagh, Northern Ireland. He received a B.Sc. degree in electrical engineering from the Queen's University of Belfast, Northern Ireland, in 1959 and 1963, respectively. From 1963 to 1966 he was a Department of Scientific and Industrial Research and Ministry of Aviation postdoctoral research fellow in the Department of Electrical Engineering, University of Leeds, England. From 1966 to 1968 he was a postdoctoral fellow, Division of Sponsored Research, in the Center for Materials Science and Engineering at MIT. He was a staff member from 1968 to 1995 at Lincoln Laboratory.