

**Project Report  
TIP-93**

**Modular Aid and Power Pallet (MAPP):  
FY18 Energy  
Technical Investment Program**

**J.A. Macomber  
A. Whitehead  
A.L. Pina  
J.H. Sack  
P.T. Klein**

19 April 2019

---

**Lincoln Laboratory**  
MASSACHUSETTS INSTITUTE OF TECHNOLOGY  
*LEXINGTON, MASSACHUSETTS*



---

This material is based upon work supported by the United States Air Force under Air Force Contract No.  
FA8721-05-C-0002 and/or FA8702-15-D-0001.

Approved for public release. Distribution is unlimited.

This report is the result of studies performed at Lincoln Laboratory, a federally funded research and development center operated by Massachusetts Institute of Technology. This material is based on work supported under Air Force Contract No. FA8721-05-C-0002 and/or FA8702-15-D-0001. Any opinions, findings and conclusions or recommendations expressed in this material are those of the authors and do not necessarily reflect the views of the U.S. Air Force.

© 2019 MASSACHUSETTS INSTITUTE OF TECHNOLOGY

Delivered to the U.S. Government with Unlimited Rights, as defined in DFARS Part 252.227-7013 or 7014 (Feb 2014). Notwithstanding any copyright notice, U.S. Government rights in this work are defined by DFARS 252.227-7013 or DFARS 252.227-7014 as detailed above. Use of this work other than as specifically authorized by the U.S. Government may violate any copyrights that exist in this work.

**Massachusetts Institute of Technology  
Lincoln Laboratory**

**Modular Aid and Power Pallet (MAPP):  
FY18 Energy Technical Investment Program**

*J.A. Macomber*

*A. Whitehead*

*A.L. Pina*

*J.H. Sack*

*Group 73*

*P.T. Klein*

*Group 77*

**Project Report TIP-93**

**19 April 2019**

Approved for public release. Distribution is unlimited.

**Lexington**

**Massachusetts**

This page intentionally left blank.

## EXECUTIVE SUMMARY

Electric power is a critical element of rapid response disaster relief efforts. Generators currently used have high failure rates and require fuel supply chains, and standardized renewable power systems are not yet available. In addition, none of these systems are designed for easy adaptation or repairs in the field to accommodate changing power needs as the relief effort progresses. To address this, the Modular Aid and Power Pallet, or MAPP, was designed to be a temporary, scalable, self-contained, user-focused power system.

While some commercial systems are advertised for disaster relief systems, most are limited by mobility, custom battery assemblies (with challenges for air transport, ground mobility, or both), and the ability to power AC loads. While the first year system focused on an open architecture design with distributed DC units that could be combined to serve larger AC loads, the second year succeeded in minimizing or eliminating batteries while providing AC power for both the distributed and centralized systems. Therefore, individual modules can be distributed to power small AC loads such as laptop charging, or combined in series for larger loads such as water purification. Each module is powered by a small photovoltaic (PV) array connected to a prototype off-grid Enphase microinverter that can be used with or without energy storage. In addition, an output box for larger loads is included to provide a ground fault interrupt, under/over voltage relay, and the ability to change the system grounding to fit the needs of a more complicated system.

The second year MAPP effort was divided into two phases: Phase 1 from October 2017 to March 2018<sup>1</sup> focused on refining requirements and vendor selection, and Phase 2 from March 2018 to October 2018<sup>2</sup> focusing on power electronics, working with the new Enphase microinverter, and ruggedizing the system.

The end result is the Phase 2 effort has been designed, tested, and proven to form a robust AC power source that is flexible and configurable by the end user. Our testing has shown that operators can easily set up the system and adapt it to changing needs in the field.

---

<sup>1</sup>Phase 1 team: Jean Sack (PI), Alex Pina, Jim Macomber, Peter Klein, Greg Tolj (co-op)

<sup>2</sup>Phase 2 team: Jim Macomber (PI), Andrew Whitehead, Greg Tolj (co-op), Chris Smith, Brice MacLaren, Erin Walker (intern)



Figure 1. Second year Phase 2 prototype (isometric and front).

## TABLE OF CONTENTS

	Page
EXECUTIVE SUMMARY	iii
1. INTRODUCTION AND BACKGROUND	1
1.1 Requirements from the Field	1
1.2 Year 1 Modular Aid and Power Pallet System Overview	2
2. MAPP YEAR 2 PHASE 1	3
2.1 Puerto Rico Deployment: WARP	3
2.2 Architecture Concepts	4
2.3 Requirements Solidification Vendor	8
2.4 Identification	10
3. MAPP YEAR 2 PHASE 2	15
3.1 MAPP Year 2 Phase 2 Design	15
3.2 Microinverters	17
3.3 Inverter Enclosure Photovoltaic	18
3.4 Solar Panels Output Box	20
3.5 Connectors and Cabling System	21
3.6 Tradeoffs	23
3.7 System Testing	26
3.8	28
4. FUTURE WORK	37
APPENDICES	
A VENDOR RESEARCH	39
B ENPHASE SPECIFICATIONS	41
C INVERTER ENCLOSURE SCHEMATIC	43

TABLE OF CONTENTS  
(Continued)

	Page
D OUTPUT ENCLOSURE SCHEMATIC	45



## LIST OF FIGURES

<b>Figure No.</b>		<b>Page</b>
1	Second year Phase 2 prototype (isometric and front).	v
2	First year system CAD render packed for deployment (left) and connected prototype (right).	2
3	MAPP Year 1 DC power distribution system.	5
4	Example AC power distribution system using microinverters.	12
5	Solar panels linked and connected to a string inverter.	13
6	Top Row: Solantro; CyboEnergy; Chilicon Power; Darfon; Enphase. Bottom Row: ZeroBase; Solar Stik; Power Blox; SolPad.	14
7	MAPP second year Phase 2 prototype: Grey output enclosure; tan (solar firmware) and orange (battery firmware) inverter enclosures and COTS PV panels. Interconnecting cable sets housed inside enclosures for transport.	15
8	MAPP Year 2 Phase 2 System architecture setup examples: connections with battery (left); stand alone inverter unit (center); solar only with arbitrary output location (right).	16
9	Inverter enclosure exploded view.	17
10	Inverter enclosure with cables stowed and multiple inverters setup for test.	19
11	Phone charging with a single inverter module and ungrounded connector.	20
12	Voltage data from ANSI C84.1 with acceptable voltage limit from the inverter, showing the need for load protection.	21
13	Output enclosure with stowed cables.	22
14	Receptacle on the output enclosure.	23
15	Phoenix contact connectors.	24
16	Interconnecting AC receptacle (left) and cable (right).	25
17	NEMA 1-15R ungrounded connector, which can be used directly with any MAPP AC interconnecting port (left), NEMA 5-15R as seen on the output enclosure (right).	25
18	NEMA 1-15R, 5-15R and L2-20R (240VAC), 2-15R (240VAC) receptacles (right, clockwise from top left), compared to IEC 309 (120VAC) panel receptacle (right).	26

**LIST OF FIGURES**  
**(Continued)**

<b>Figure No.</b>		<b>Page</b>
19	Microninverter power on, and load step off.	29
20	Shading of PV and droop response.	30
21	Load step response.	31
22	Battery charging followed by applied load.	32
23	Battery supporting the load followed by load being removed and battery charging.	32
24	Solar loading temperature testing.	33
25	Steady-state temperature testing.	34
26	Artificial PV shading with load drop and recovery.	35
27	PV testing with battery; load step off, battery goes from discharge to charge.	36

## 1. INTRODUCTION AND BACKGROUND

When a disaster occurs, damage to electric and transportation infrastructure is common. Power outages simultaneously spike the demand for backup power generation and disable electric fuel pumps and grid-tied residential solar power systems. In addition, non-ideal operating conditions can result in frequent system failures. As damaged roads delay fuel and supplies from being delivered, any power systems relying on supply chains for delivery, repair, or operation face serious logistical challenges.

Disaster relief situations also require a wide and fluid range of loads and distribution. Early needs for search lighting or cell phone charging require small scale distributed power, while developing needs for medical equipment or water purification require larger, centralized power. Finally, users may not have any technical training, making intuitive system setup, use, and repair critical.

### 1.1 REQUIREMENTS FROM THE FIELD

Feedback from Humanitarian Aid and Disaster Response (HADR) experts was critical in defining potential use cases and requirements for MAPP. Conversations with the Red Cross, Team Rubicon, NJTF1, IHS Roddenberry, Doctors without Borders, HHI, Partners in Health revealed common challenges with non-experts needing to obtain consistent power under changing conditions. These conversations also highlighted a frequent lack of situational power awareness in the HADR space.

In addition, a set of requirements were summarized in the 2017 Hurricane Season FEMA After-Action Report Recommendations summary:

- Create preparedness and planning products that are easily accessible, modular, inclusive, and readily executable
- Broaden FEMA's capability to quickly get teams on the ground to stage and deliver key commodities to disaster survivors, even in the most remote locations
- Streamline storage and movement across multiple modes of transportation that facilitate and speed delivery
- Develop a more comprehensive understanding of local, regional, and national supply chains, as well as stronger relationships with critical private sector partners to support rapid restoration in response to catastrophic incidents
- Support state, local, tribal, and territorial governments in improving capability for disaster cost recovery, pre-event contracting and contract enforcement, and vendor-managed inventory

- Encourage investment in redundant assets to maintain communications and supply temporary power

## 1.2 YEAR 1 MODULAR AID AND POWER PALLET SYSTEM OVERVIEW

The first year Modular Aid and Power Pallet (MAPP) system was a proof of concept disaster relief prototype. After year 1, MAPP consisted of (10) DC power strings and an inverter, packaged onto a standard shipping pallet for easy deployment, as shown in Figure 2.



Figure 2. First year system CAD render packed for deployment (left) and connected prototype (right).

Each DC power string, sufficient for distributed lighting and cell phone charging, consisted of two semi-flexible solar panels, a battery box, an electrical box, and two connecting cables. Each of these components weighed less than 20 kg to allow for hand carry distribution, with the ability to combine (5) to (10) DC power strings with an inverter box for a centralized, AC power system. Connection points were minimized, color-coded and keyed, and a pictorial user manual created to allow use by non-technical, international, or illiterate customers. Redundancy between components in the DC units was important to make the system fault tolerant, and the use of standard connectors and commercially available components (with the exception of a custom build ideal diode) was intended to enable replacements and repairs in the field. The first year effort was successfully completed and demonstrated ahead of schedule and under budget, meeting the first-year allocated funding goals of designing, building, and demonstrating a full-scale system.

## 2. MAPP YEAR 2 PHASE 1

The second year MAPP effort was divided into two phases: Phase 1 from October 2017 to March 2018<sup>3</sup> focused on evaluating alternative architectures refining requirements and vendor selection, and Phase 2 from March 2018 to October 2018<sup>4</sup> focusing on power electronics, working with the new enphase microinverter, and ruggedizing the system.

### 2.1 PUERTO RICO DEPLOYMENT: WARP

In the aftermath of Hurricane Maria, MIT LL leadership asked the MAPP team to send the first year prototype as aid to Puerto Rico. As this system was not intended for field testing, an alternative COTS solution was designed by GeoInnovation and members of the MIT Lincoln Laboratory Energy Systems and Humanitarian Aid Disaster Relief groups. The resulting Water Aid & Renewable Power (WARP) system was used to power a water purification system provided by Infinitum Humanitarian Systems (IHS) on the roof of the Loiza Boys and Girls Club. This system was deployed in collaboration with IHS and with significant support from Jim Macomber in remote integration troubleshooting. While not part of the MAPP program, WARP (led by Erik Limpaecher) provided field observations and requirements verifications for Phase 1, and drove the technology development for Phase 2.

The Puerto Rico deployment confirmed the MAPP design concept of using small, modular components. This architectural approach reduces the risk of single-point failures due to damage or transportation loss. Small, lightweight, man-portable enclosures eliminate the need for material handling equipment such as forklifts.

The WARP deployment tested and confirmed the value of deploying a solar-only, battery-less energy system. MAPP year 2 incorporated this lesson by developing a system that can operate solar-only, and can optionally include batteries.

The Puerto Rico deployment encountered a significant issue in integrating its solar-only power source with an intermittent water purification load. The deployment nearly failed due to the load repeatedly tripping the inverter and locking it out until it was manually reset. The solution required a modification to the load itself. For MAPP, which is a general-purpose disaster response system, these problems underscore the need for testing with a wide range of loads. This is described in the Future Work section. The WARP design, in contrast, will likely pursue tighter integration between the load and source, including potential load control and proactive load shedding.

---

<sup>3</sup>Phase 1 team: Jean Sack (PI), Alex Pina, Jim Macomber, Peter Klein, Greg Tolj (co-op)

<sup>4</sup>Phase 2 team: Jim Macomber (PI), Andrew Whitehead, Greg Tolj (co-op), Chris Smith, Brice MacLaren, Erin Walker (intern)

Cabling, connectors, and cable conduits were one of the most time-consuming and error-prone elements of the WARP deployment, and where the MAPP and WARP designs take significantly different approaches. The MAPP year 2 design uses custom cables with rugged connectors, rather than cables that are cut to length in the field. MAPP did not add armoring or conduit to the cables. Since MAPP is intended for temporary installations, a relatively heavy cable with rugged insulation was selected.

One of the most difficult parts of the deployment was transportation logistics. This emphasized the importance of compatibility with commercial airline luggage requirements, as well as challenges associated with hand or car transport on the ground. Components under 100 lbs packaged in rugged cases with handles and wheels (such as custom pelican cases) were relatively simple to get to site, whereas large or heavy components such as batteries or large solar panel arrays were difficult, inefficient, or unfeasible to accommodate. Therefore only minimal battery energy storage (in the form of small, rechargeable batteries) should be deployed with the system, and additional energy (including mechanical) or water storage systems or tanks should be sourced on site. If no additional energy storage is available, daytime only operation can be acceptable as few people will be using centralized resources after dark.

In addition to general mobility, finding the right location for the system is critical. Numerous site assessments with a survey checklist of fixed selection and exclusion criteria are essential, as is finding the right contact within the affected population to take ownership of the system and integrate it into the local economy. This contact must be trained and educated about the system design assembly, and business operation, and must be able to perform maintenance, collect and upload data, and troubleshoot the system. Simple, manual status indicators as well as unique QR codes on each component with links to replacement parts, training videos and manuals are helpful, and a streamlined system with co-designed power and load can also be useful to minimize confusion.

## **2.2 ARCHITECTURE CONCEPTS**

A number of alternative architectures were investigated to streamline the MAPP system and minimize weight while maintaining a simple to use, modular and scalable system. These systems can use either DC or AC power distribution systems with a variety of converters and inverters as summarized below, where the internal power architecture dictates many of the features and functions required.

### **2.2.1 DC Power Distribution Systems**

In a DC power distribution system, sources and storage are combined at a common DC voltage, and use DC/DC converters to control voltage and currents. DC loads are driven from the DC

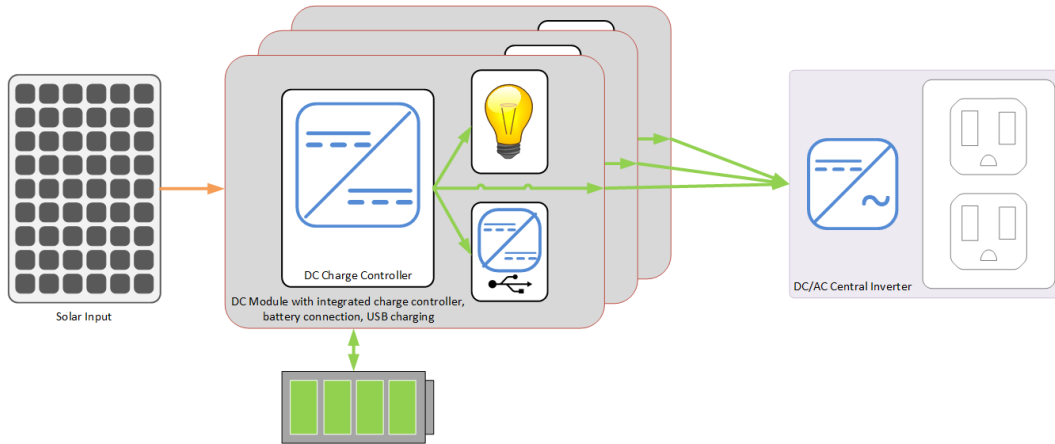

Figure 3. MAPP Year 1 DC power distribution system.

link either directly or with a DC/DC converter, and AC loads are fed via a central inverter, as with MAPP Year 1. DC power distribution architectures allow for more control of the DC requirements, which can simplify controls and battery connections as it does not require synchronization and power factor considerations associated with an AC distribution system. The disadvantages of this approach are potential inefficiencies if most of the loads are AC, system integration challenges, and component limitations allowable on a DC bus. The MAPP Year 1 DC power distribution system architecture block diagram is shown in Figure 3. The MAPP Year 2 system eliminated all DC power outputs from the design; it only provides AC power.

DC-DC converters connect sources and loads that use different DC voltages. These converters are used to interface from a PV panel to a battery (charge controller), from a low voltage battery to a high voltage inverter, or within a battery bank for battery or cell management. In the case of DC loads, a converter is used to regulate a DC bus to the required voltage for that load. More advanced architectures use bi-directional inverters to allow excess energy from an AC generation source to be absorbed into the hybrid storage elements, though these also require either bi-directional DC-DC converters or AC transformers to charge or discharge the batteries.

Solar chargers function as DC-DC converters to charge batteries from photovoltaic (PV) solar panels. These chargers often include a Maximum Power Point Tracking (MPPT) algorithm to maximize PV power and the ability to charge and manage several battery voltages or chemistries. Some also have low voltage disconnects to prevent energy draw from batteries with a state of charge below a defined threshold. These differ from bi-directional inverters in that power flow is always from a solar source into the battery. Battery charge controllers must be matched to the battery

chemistry and battery bank voltage, either via a configuration within the controller, or by selecting a fixed charger for specific batteries. Converting PV from DC to a regulated DC voltage of a battery bank and then converting through an inverter to AC will result in additional efficiency losses.

Cell balancing can extend the system life of hybrid systems, and allow more flexibility in system assembly, as individual batteries do not need to be closely matched in a battery bank. Active management is more efficient than passive balancing as the energy to balance is used instead of dissipated in a resistor, but either type of cell balancing will include higher component costs and additional system design complexity.

A DC power distribution system with only a single direction inverter can recharge a battery bank by use of a power supply or an AC-DC charger to charge from a generator. While this hardware is readily available, this approach results in a complex system controller and the additional hardware components over an AC distribution system.

### **2.2.2 AC Power Distribution System**

In an AC link power system, individual DC components interface via inverters onto a common AC bus. Each element is required to synchronize to the appropriate frequency and voltage, with a controller that can form a grid or follow an existing grid. Systems like this can take advantage of existing power distribution systems, and some can allow for multiple sources while serving as the point of common coupling. PV in an AC link system can be achieved with a single central inverter tied to the PV string, or with multiple microinverters, each tied to a single PV panel and to the AC grid.

Inverters convert DC power from solar arrays or batteries to AC power so it can be combined with power from AC power sources such as generators. Most hybrid power system controls are typically integrated into the power converters including synchronization, maximum PV power point tracking (MPPT), and reactive power compensation. While inverters have a variety of operating modes, off-grid or grid-forming capabilities are critical for MAPP. Grid-feeding modes are required to synchronize to a running generator and provide current to the grid (and if bi-directional, from the grid to a load or battery), and many solar inverters only support this mode due to the intermittent nature of the solar energy. Grid-supporting inverters are also required to synchronize to an AC source and will use real and reactive power to adjust the frequency and voltage of the AC bus.

The phase configuration of an AC distribution system is critical to the specification of an inverter, and there are commercially available single phase, split-phase and three-phase inverters. It is not uncommon for smaller inverters like those used in the Iris Technologies FOB power system or the Solar Stik PRO-Verter to provide single phase. Individually, these may be appropriate for



systems that can operate with smaller discrete loads, but will be insufficient for systems that need to support three phase outputs or grid-connect operation.

Load requirements also dictate whether a modified or pure sine wave is required. Modified sine wave inverters are simpler to control and implement and may be smaller and lighter, but they are not appropriate for sensitive loads and some electronic equipment due to harmonics. Higher harmonic content leads to lower efficiency and audible noise from the inverter and loads. Pure sine wave inverters are required for sensitive electronic equipment, and use faster switching and control the output wave form with filtering to provide a cleaner sine wave, although they may still have some harmonic content not present on a grid or from a generator.

Bi-directional inverters convert from DC to AC and from AC to DC, allowing energy storage to provide energy into the AC grid, or to store excess energy. This allows a system to store excess solar or generator power and then supplement or provide power during cloudy or night time conditions, or when the generator is off.<sup>5</sup> Bi-directional inverters provide a single piece of hardware that can charge and discharge batteries in a hybrid system, with a single control input dictating the power to source or sink. Some bi-directional inverters in a three phase system will also be able to correct for an unbalanced system. Disadvantages of a bi-directional inverter are the added complexity of the inverter and relative scarcity of three-phase inverters in a form that are small and light enough for a system like MAPP.

String inverters use PV sources that are combined to form a higher DC voltage source for the inverter, and MPPT is performed on the entire string instead of individual PV panels. This approach allows a single inverter to synchronize to an AC system (as shown in Figure 5), but the size and configuration of the PV string has to be configured carefully to match the inputs of the inverter, and strings in this configuration are more affected by shading than microinverters. Central string inverters have a simpler interface, with all the PV connected to a single higher voltage input without an additional gain stage. String inverters are less expensive but also less efficient as any MPPT running will optimize for the whole string and not maximize the power output from each panel.

Microinverters are small scale power converters commonly used in the renewable power market. Unlike string inverters that combine DC power from multiple PV panels, microinverters convert the DC power produced by single PV panel to AC power, with the output of multiple inverters synchronized and interconnected. This modular approach allows for MPPT to run on each PV panel, eliminates a single point of failure for the system, and simplifies scaling. Many microinverter manufacturers have implemented a trunk cable that minimizes installation time and provides a single connection to interface to an AC distribution. Microinverters add cost, require

---

<sup>5</sup>As generator efficiency increases at higher loading, cycle charging energy storage systems can also reduce fuel use.

additional voltage gain, and off-grid functionality for small units without energy storage is not yet commercially available.

Since the year 2 system was looking to streamline the system and minimize as much weight as possible, microinverters were chosen as the ideal solution. The addition of microinverters allows for modular or centralized AC power with a nominal U.S. output of 120 VAC at 60 Hz. The potential to removing energy storage from the system results in power disruptions in conditions of intermittent sunlight and prohibits overnight operation, but makes for a much lighter system and significantly reduces transportation logistics. The lack of commercially available off-grid units, however, resulted in a number of half-way solutions (including oversized inverters for each panel) before prototype off-grid units from Enphase became available for Phase 2. Figure 4 show an example of AC interconnection using microinverters.

### 2.3 REQUIREMENTS SOLIDIFICATION

Between the requirements developed in MAPP Year 1 the lessons learned from collaborating with IHS, and an evaluation of additional architectures, the following requirements document was created to evaluate existing and potential systems available from commercial vendors.

#### SYSTEM OVERVIEW

The Modular Aid and Power Pallet (MAPP) program intends to procure a modular set of solar power generation and energy storage components for rapid field deployment to remote areas. MAPP units are intended to operate either distributed, or connected, to enable scaled power and energy, and all components must be easily transported requiring minimal system size and weight. Flexibility in field assembly and repair is critical, requiring the use of commercially available components. Energy storage, which may be contained in the distributed and/or centralized systems, is needed for short periods of cloud cover, and to power small overnight loads. Teams with some basic electrical training will perform the installations.

T = Threshold (minimal acceptable solutions) O = Objective (desired solution)

#### ALL SYSTEMS AND CONFIGURATIONS

##### Packaging

- Environment rated during transport and use T: IP65 O: IP67 or better
- T: Easy to open, re-sealable packaging with carrying handles and tie downs (e.g., Pelican Case)
- O: Transportable by commercial airline

- Maximum sub-system with case weight T: <100 lbs, O: <50 lbs
- Maximum total system weight T: <2000 lbs, O: <1000 lbs

#### Location

- Solar irradiance: 3.5 kWh/m<sup>2</sup>/day

#### Electrical

- Field replaceable T: PV panel, battery, O: Solar charge controller, DC/AC inverter
- T: Must be possible to source all power generation from solar PV
- T: Re-chargeable from AC grid (i.e., before deployment, when intermittent grid exists in the field)
- Inverter T: 2x steady state surge for 1 second
- Battery storage charged within T: 6 hours, O: 2 hours
- O: Interchangeable battery chemistry (lithium ion and lead acid)

#### Connectors

- Standard COTS connectors T: MC4 for solar connections

#### Communication

- T: Communication bus as required, O: No additional wiring for communication

#### Documentation

- Must provide documentation on the operating voltage and ranges for power transfer
- Must provide an installation, operation, and troubleshooting manual

### DISTRIBUTED SYSTEM

#### Packaging

- Maximum system weight per distributed system T: <100 lbs, O: <50 lbs

#### Electrical

- Solar PV and battery powered T: standard 48/72 V panel, T: 12 V battery O: 48 V battery
- Output T: 60 Hz AC, 120 V, pure sine wave O: 5 V regulated USB, 2 A each plug
  - Daytime operation T: 200 W steady state for 6 hours, O: >400 W
- Indicators for O: fault, battery SOC, available power, mode of operation (distributed/centralized), low-voltage disconnect

## Energy Storage

- T: 200 W for 15 minutes, O: 50 W steady state for 18 hours

## Connectors

- USB T: (6) outlets, O: (12) outlets
- NEMA 5-15R GFCI 120 V outlet T: (1), O: (2)

## CENTRAL SYSTEM

## Packaging

- Vendor shall supply interconnect cables
- Full installed Central System must be less than T: 450 ft<sup>2</sup>, O: 300 ft<sup>2</sup>

## Electrical

- T: Powered from distributed AC systems and additional battery modules
- Output T: 60 Hz AC, 120 V, pure sine wave
  - Operation with full sun day T: 1 kW steady state, O: >1.5 kW

## Energy Storage

- Discharge rate must provide T: 1 kW, O: 1.5 kW
- Useable stored energy T: 2 kWh, O: 3 kWh (can include Distributed System energy storage)
- Battery storage charged within T: full sun day O: 2 hours

## Connectors

- (4) NEMA 5-15R GFCI 120 V outlets
- Central AC System will incorporate (2+) Distributed Systems for power generation

## 2.4 VENDOR IDENTIFICATION

A number of vendors were investigated to provide critical components (namely an off-grid microinverter) or full functioning system. While a number of manufacturers (including Darfon, Chilicon, Cyboenergy, Solantro, and Enphase) could provide microinverters, none of the commercially available units could function off-grid without a battery reference.<sup>6</sup> Of these systems, Solantro was working on a reference design and chip set with Darfon that might have been possible to integrate into a microinverter built in house, and Enphase was in early stage prototyping an off-grid,

---

<sup>6</sup>It appeared that Darfon used to sell this type of unit in India, but it was never available in the U.S. and they ceased manufacturing them.

bidirectional, 240VAC micro inverter that did not need a battery. As working with the Solantro or Enphase solutions required a significant program shift, commercially available systems were investigated to see if there were available, and could then be retrofitted once the microinverters became available. A selection of the products investigated are provided in Figure 6 with detailed information provided in Appendix 1.

Many of the commercially available, packaged systems (such as Power Blox, Zero Base, Iris Technologies, and Solar Stik) were similar to the MAPP concept, but lacked the flexibility, durability, scaling, and transportation requirements. During interviews with Solar Stik and Zero Base, however, the companies proposed custom solutions that could better meet the requirements. RFQs were sent to Solar Stik, Zero Base, and Iris Technologies, and Solar Stik and Zero Base replied with custom assemblies. The acceptable Solar Stik proposal is proprietary and not included in this document, but contact information will be provided upon request.

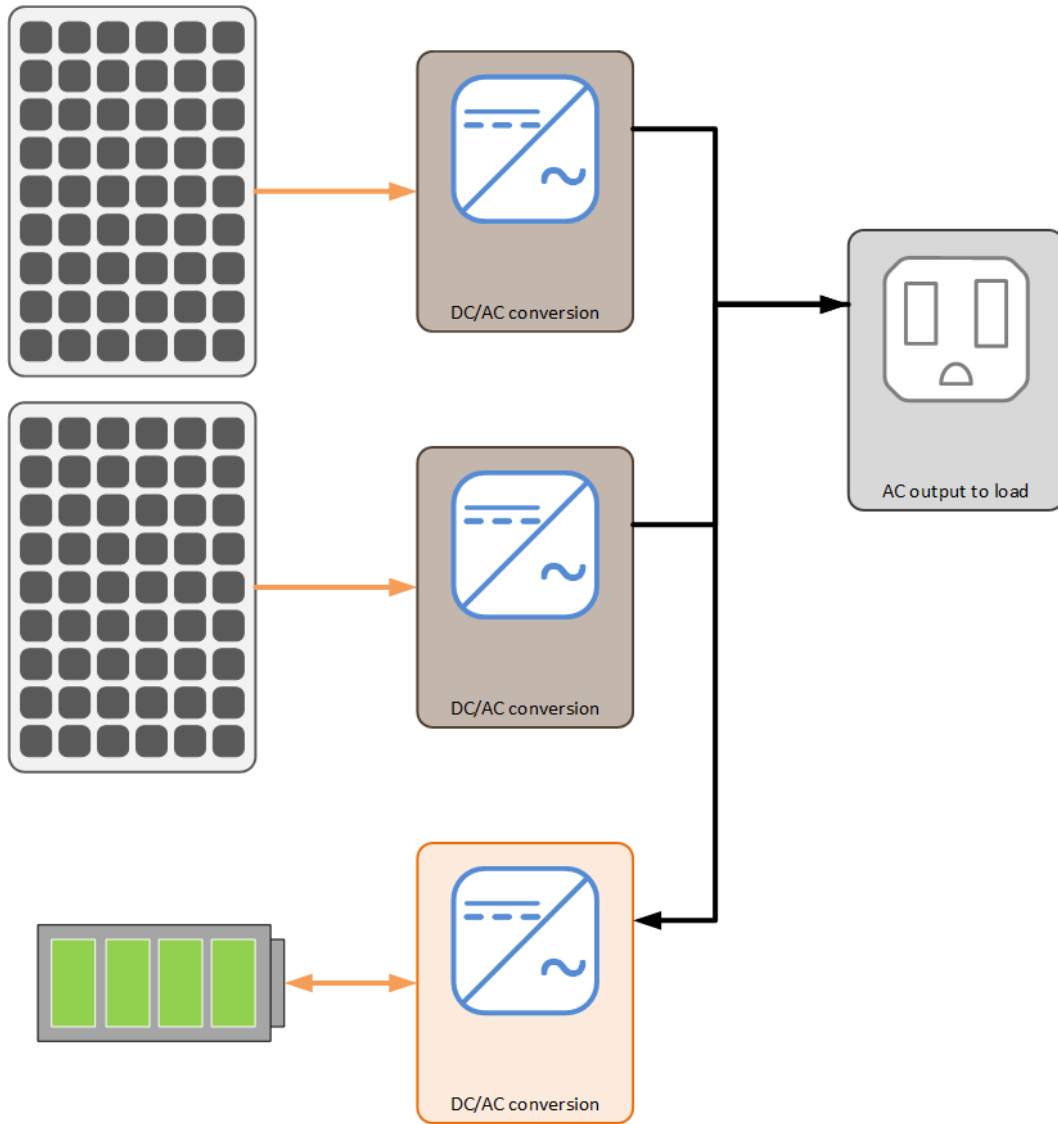

Figure 4. Example AC power distribution system using microinverters.

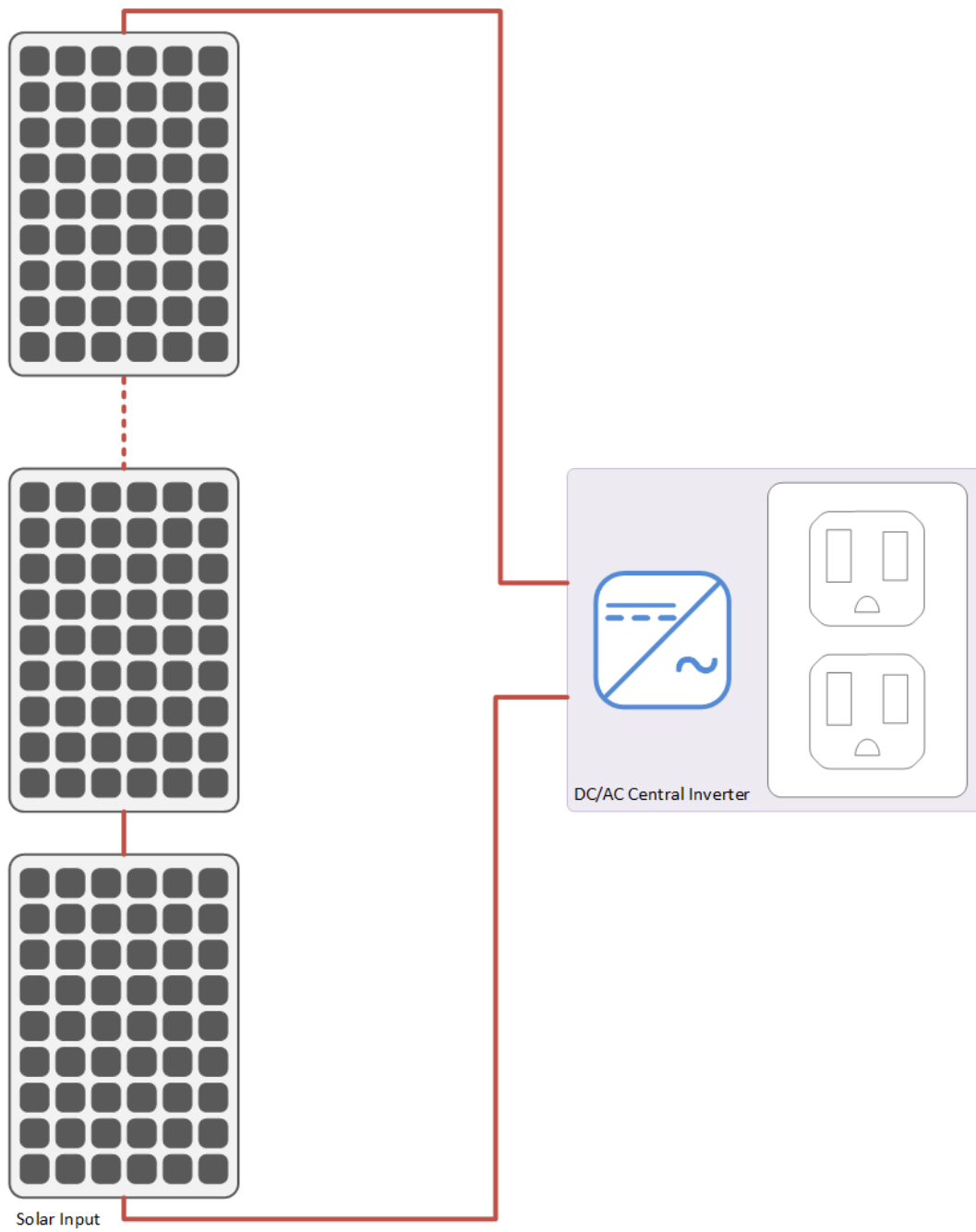

Figure 5. Solar panels linked and connected to a string inverter.



Figure 6. Top Row: Solantro; CyboEnergy; Chilicon Power; Darfon; Enphase. Bottom Row: ZeroBase; Solar Stik; Power Blox; SolPad.



### 3. MAPP YEAR 2 PHASE 2

As a viable commercial system was able to meet the initial system requirements, and prototype Enphase microinverters became available, the program shifted to development and integration of microinverters and elimination of energy storage. The system can be scaled from a single unit to the current limit of the interconnecting wiring, and is intended to provide field recharging for batteries, search and rescue equipment for radios and other communications, and potentially remote testbeds. The output enclosure provides additional load protection and a way to customize grounding schemes to match field requirements, and all alterations to the water-tight enclosures are weatherproofed with gaskets and sealing connectors. In addition, all electrical connections were built into a recessed, 3D printed shell that was integrated into commercially available pelican cases. The system was also designed with OSHA lifting limits, MIL-STD-1472G, and air transport compliance in mind.



Figure 7. MAPP second year Phase 2 prototype: Grey output enclosure; tan (solar firmware) and orange (battery firmware) inverter enclosures and COTS PV panels. Interconnecting cable sets housed inside enclosures for transport.

#### 3.1 MAPP YEAR 2 PHASE 2 DESIGN

In addition to the functional system requirements, a variety of practical considerations for the system were explored. These include the user interface (setup, maintenance and repair), flexibility to include distributed or centralized energy storage in the field, and overall system efficiency.

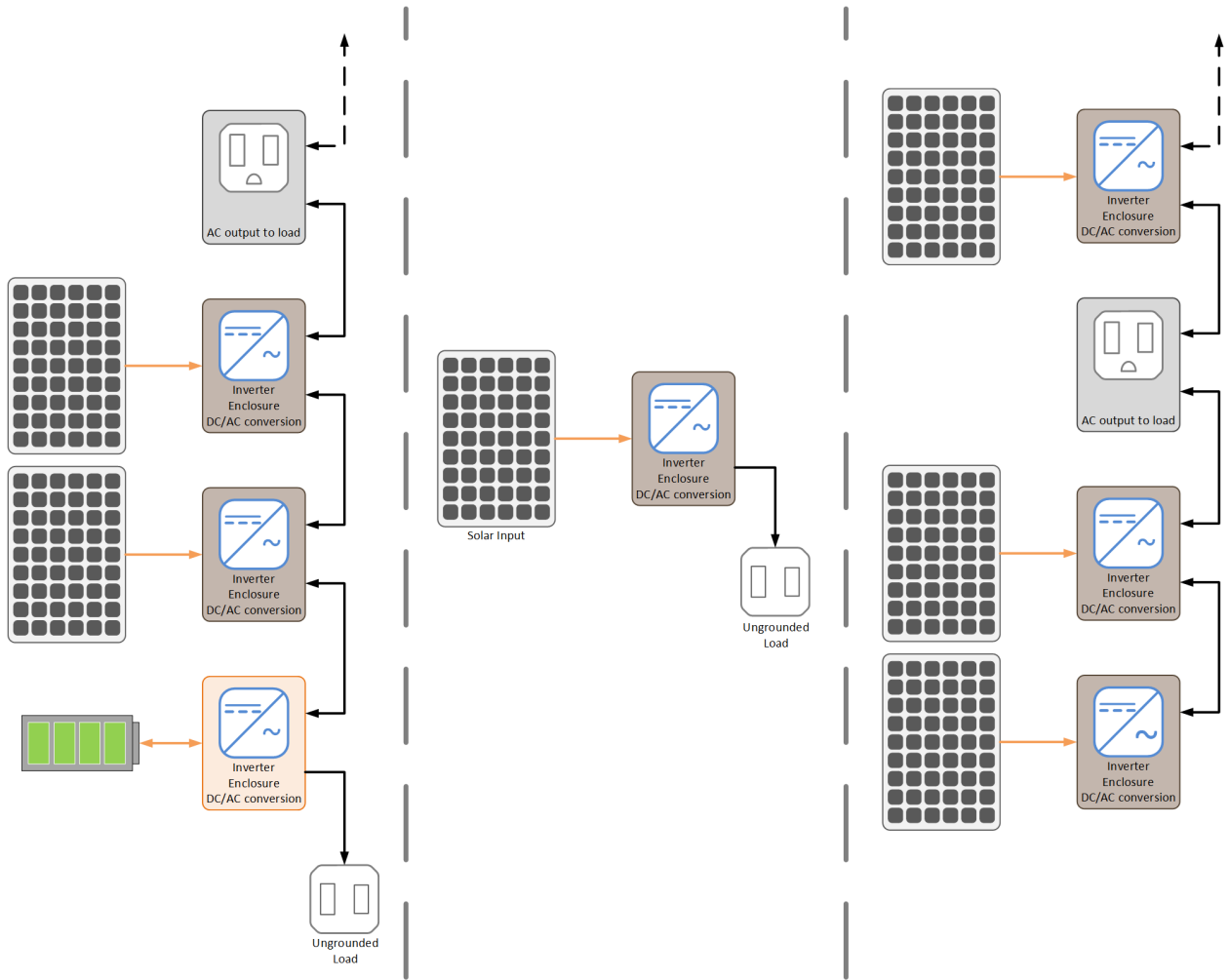

Figure 8. MAPP Year 2 Phase 2 System architecture setup examples: connections with battery (left); stand alone inverter unit (center); solar only with arbitrary output location (right).

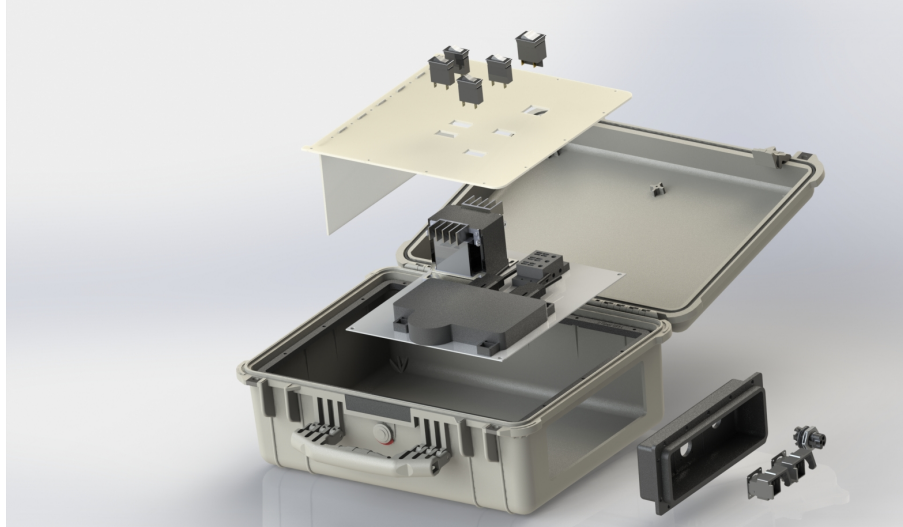

Figure 9. Inverter enclosure exploded view.

### 3.2 MICROINVERTERS

Enphase’s prototyping and development of the IQ8 line of microinverters with the off-grid mode without the need for batteries was a critical enabler for making MAPP work with the AC interconnection architecture without having to develop an in-house microinverter. The off-grid mode is a major development driver for the IQ8 series and is likely to be continued for full production, though it is unclear how a planned gateway into the product chain will affect availability.

The IQ8+ hardware is very similar to the IQ7+ (with performance data for the Enphase IQ7 and IQ7+ Microinverters provided in Appendix 2) though the control IC and firmware are different. While working with Enphase to procure some of these prototypes, MTILL had the opportunity to adjust some of the control parameters to better suit MAPP, such as a functionality to shut down the microinverter if the AC load was too small.<sup>7</sup> All received prototypes were pre-commissioned for off-grid mode, will start generating AC power in one second of startup with appropriate PV input, and will automatically synchronize with an existing grid.<sup>8</sup>

The Enphase microinverters do not require a battery for reference, but should be able to integrate batteries available onsite once the firmware is updated and the units are production ready.

---

<sup>7</sup>This option, however, could be valuable for an inverter configured for a battery, if combined with a smarter output box that could load schedule, or many batteries on a system to run only what was needed and keep as many battery inverters at a minimum power mode to prolong the battery charge.

<sup>8</sup>The IQ8+ was designed for massive parallel operation for on-grid use, and could functionally work with an existing utility grid. However, this is not a legal operation due to the pre-commissioning which eliminates the anti-islanding, lack of certification of the prototypes, and the harmonic current injection the microinverters use to improve THD on the AC connections.

**TABLE 1****Battery parameters internal to the Enphase inverter as configured for MAPP**

<b>Battery Parameter</b>	<b>Value</b>	<b>Notes</b>
Vmax	42.9 V	Max charging voltage. Inverter will switch into constant voltage mode once this voltage is reached
Vmin	33.6 V	Max discharge voltage. Inverter will turn off once this voltage is reached
AChaMax	15 A	Max charge current
ADisChaMax	100 A	Max discharge current
AChaMin	0.1 A	Min charging current when in constant voltage mode. If current falls beneath this threshold, turn off
VMinFloat	40.8 V	After AChaMin is hit, re-enter constant voltage mode when the battery hits this voltage

Enphase also has some parameters that would allow MAPP to customize the battery modes, as outlined in Table 1.

### 3.3 INVERTER ENCLOSURE

The IQ8+ microinverters are designed to be self-contained and permanently installed on rooftops or behind solar panels and wired into building mains for operation. To adapt them for temporary and modular use, a more flexible interconnection method, circuit protection for each module (as they can be stand alone modules), and output voltage reduction to end user levels was required. Also, while efficiency could be maximized and cabling minimized by running at the output 240 VAC, few devices and connectors are compatible so a step-down transformer was used to provide 120 VAC.

The connections on the side of the enclosure are built into a recessed, 3D printed shell for protection during transport. Inside the enclosure, laser cut acrylic sheets were used to make a shroud for electronics, provide a mounting point for the circuit breakers, and provide a separated

storage section for cables.<sup>9</sup> Shrouding the electrical wiring was essential to isolated mounting screws, and prevent accidental user contact with higher internal voltages. The system was tested against a COTS isolation transformer though customer transformers. Auto-transformers should be considered in the future to reduce weight and losses.

The resulting inverter enclosures are self contained with all connectors, and a production system should include a manual, small screw driver, and MC4 disconnect tool.



Figure 10. Inverter enclosure with cables stowed and multiple inverters setup for test.

---

<sup>9</sup>A special thank you to Dave Scott and TOIL for expertise, assistance, and training on the 3D printer and laser cutter.

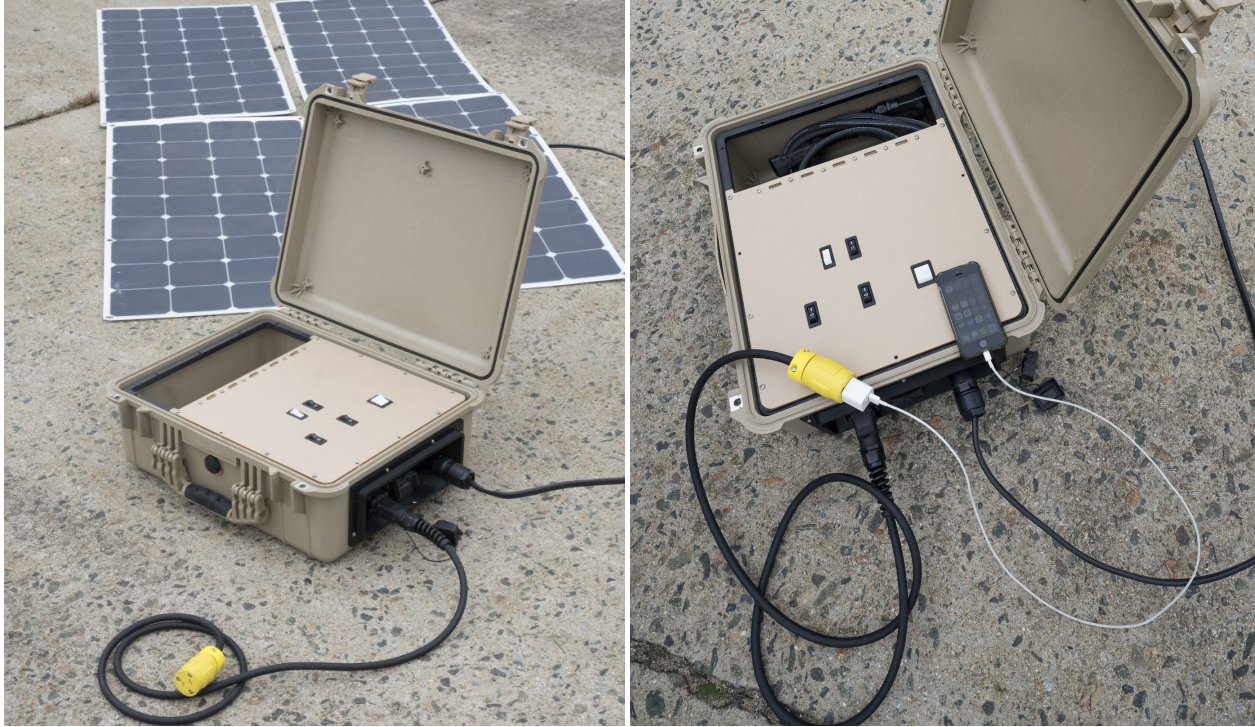

Figure 11. Phone charging with a single inverter module and ungrounded connector.

### 3.4 PHOTOVOLTAIC SOLAR PANELS

Photovoltaic (PV) modules were selected for energy generation due to their widespread availability, ease of use, and operational independence from supply chains. MAPP is designed for use with 400 W of total solar generation per module from a combination of panels with standard MC4 connectors. However, as delivery and robustness is critical for disaster relief, semi-flexible, monocrystalline silicon panels, have been selected for the initially delivered MAPP kit. These panels are PET/EVA/TPT<sup>10</sup> laminated, making them much lighter, more durable, and more impact-resistant than more common glass encased rigid modules. The system was designed to use two panels in series and two series pairs in parallel to provide sufficient power at the appropriate voltage. The panels used are the same as used in the previous version of MAPP as the weight, size, and modular concept were still a good fit.

Each module has the same AC coupling connections: an Anderson Power Products connector set that allows the same hardware to be used for both sides of the connection, and a weather-tight backshell set that provides the connector gender. This allows the cable set to be connected in either direction while maintaining a safe system for an inexperienced user and preventing back-fed receptacles. These connections also can be reconfigured as needed in the field with a small screw driver and wrench.

---

<sup>10</sup>Polyethylene terephthalate/Ethylene vinyl acetate/Tedlar Polyester Tedlar.

### 3.5 OUTPUT BOX

In the initial design of the microinverter based architecture, the goal was to only use one type of enclosure and include all required output cabling to power typical loads. This approach fell short, however, when evaluated for load protection and system grounding. As the system is designed not to require energy storage, any PV intermittency has an immediate affect on source power. This results in a dip in voltage and frequency according to the Enphase droop control, which is unacceptable for sensitive and constant power loads as shown in Figure 12.

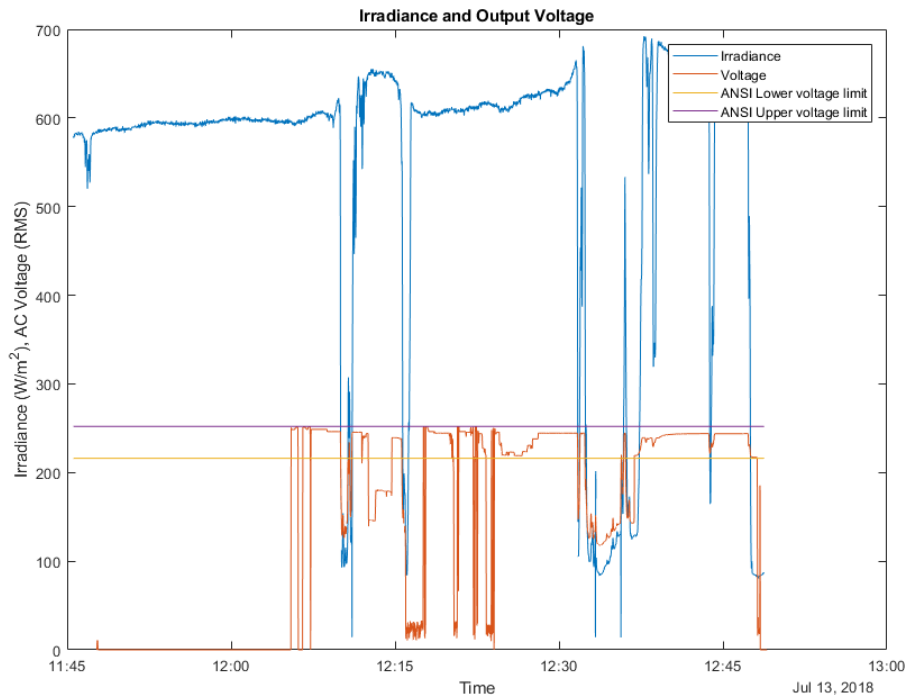

Figure 12. Voltage data from ANSI C84.1 with acceptable voltage limit from the inverter, showing the need for load protection.

Therefore, output protections were installed including a configurable voltage control relay, a timer relay and a ground-fault circuit interrupter. When the microinverters are under or overloaded, the droop controls will let the voltage and frequency increase or decrease respectively. The voltage

control relay will open the output when the incoming voltage is outside a settable range for over a settable time frame.<sup>11</sup> When the microinverters power on or recover from a fault or overload, they will delay for 1 second before ramping the output up. The output of the voltage range relay feeds a multifunction relay configured as a timer, and the output will not be energized until the voltage is within range for 3 seconds. This provides ample time for all the inverters installed to synchronize with each other and provide a steady operating voltage. The final stage in the output enclosure is the ground fault circuit interrupter (GFCI). This is done only on the AC side as Enphase includes DC GFCI protection on their IQ series microinverters.



Figure 13. Output enclosure with stowed cables.

The output enclosure also contains a jumper that makes the neutral-ground bond to allow MAPP to operate as a separately derived AC system.<sup>12</sup> In any cases where multiple output boxes are employed, this bond must be broken in all but one enclosure. In order to provide a means of connecting to an external grounding electrode conductor, an aperture was added to the output enclosure to bring a 10 AWG sized conductor into the enclosure and seal it (the orange circle on Figure 14). The connection point within the enclosure is done via the green and yellow terminal blocks. A ground line is brought to all connections on the AC interconnection cables but used as a pass through for the inverter enclosures to ensure that the exposed metal screws are isolated from electrical connections. This was done to provide flexibility in the field for equipment grounding, or to use with a load that may have unique grounding requirements. The use of a GFCI is also a requirement for systems like MAPP and will open the output to the NEMA 5-15 receptacle when the

---

<sup>11</sup>Similar relays exist that can trigger on a frequency range, but these are roughly 3x the cost.

<sup>12</sup>NFPA 70, National Electric Code, 2017: Section 250.30.



differential current between the line and neutral connection exceeds 4-6 mA for 25 mS. An external GFCI tester may or may not work, however, depending on how the grounding is configured once deployed.



Figure 14. Receptacle on the output enclosure.

### 3.6 CONNECTORS AND CABLING

The MAPP system needed to be a system that could be deployed outdoors by non-expert individuals. Long cables add weight and power loss, but short cables make installation challenging with uneven or non-continuous terrain. As a result, the system was shipped with additional cables that could either be used as extensions or as replacements. In order to keep the connections safe for uses, everything is finger safe without exposed contacts that could have potential present when not connected. Therefore, re-purposing common connectors for field use was not feasible due to safety concerns. The connectors between the solar panels and the inverter boxes, between inverter boxes for a larger system, and for inverter boxes or the output box to user loads, are summarized below.

#### 3.6.1 DC Solar Connections to Inverter Boxes

MC4 are the most common connectors for solar panels but some versions are out of date as code require a tool to disconnect a locking mechanism. Older MC4 connectors latch, but do not require a tool to disengage. Therefore, PV circular connectors from Phoenix Contact, which require

a screwdriver to release the locking tab to meet NEC article 690<sup>13</sup> were used. These connectors also have simple installation and rework features.

An alternative configuration could use Anderson Power connectors for the PV input and the Phoenix Contact connectors for the AC interconnect. This may be desirable if a future version of MAPP requires a higher pin count for the AC interconnect (e.g., an interlock or for communication) as the Phoenix Contact connector is also available in a 5 pin configuration, but may also require a redesigned enclosure to provide sufficient room for the screwdriver release.



Figure 15. Phoenix contact connectors.

### 3.6.2 AC Interconnection between Inverter Boxes

Interconnections were also required between modules to scale small modules for a larger centralized system. Typical conventions for male and female connectors were avoided to allow for bi-directional power flow, and varying cable length requirements drove a connector set with both in-line and panel mount connections. The 4 Position SPEC Pak fit these requirements while requiring few additional tools to assemble. They also include a latch that is installed on the panel mount and in-line receptacle, similar to the APP locking solar connectors discussed in Section 3.6.1.

---

<sup>13</sup>NFPA 70. National Electric Code (NEC) 2017, article 690.3C: Type: The connectors shall be of the latching or locking type. Connectors that are readily accessible and that are used in circuits operating at over 30 volts, nominal, maximum system voltage for DC circuits, or 30 volts for 1c circuits, shall require a tool for opening.



Figure 16. Interconnecting AC receptacle (left) and cable (right).

### 3.6.3 AC Output Connections

A commonly used NEMA 5-15 output receptacle was installed on the output enclosure to provide the most acceptable power source to an end user (see Figure 17). This connector was selected to provide interconnected grounding to the load output (unlike the NEMA 1-15), and is compatible with standard power strips if additional outputs are required. If a different grounding scheme is needed in the field, the grounding conductor can be disconnected internally as discussed in Section 3.5. In addition, the included output cord adds an ungrounded receptacle to allow single inverter enclosures to be deployed for smaller loads like charging stations for phones, laptops, battery lanterns, or radios. The NEMA 1-15 receptacle was used for this use-case as grounding was not built into the inverter enclosure. IEC pin and sleeve connections were also considered due to their design for safe outdoor operation, but these are less familiar to most users and significantly larger, heavier, and more expensive. All of these receptacles are shown in Figures 17 and 18.



Figure 17. NEMA 1-15R ungrounded connector, which can be used directly with any MAPP AC interconnecting port (left), NEMA 5-15R as seen on the output enclosure (right).

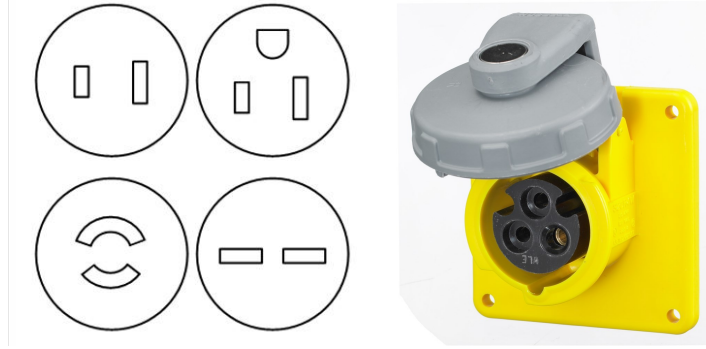

Figure 18. NEMA 1-15R, 5-15R and L2-20R (240VAC), 2-15R (240VAC) receptacles (right, clockwise from top left), compared to IEC 309 (120VAC) panel receptacle (right).

### 3.7 SYSTEM TRADEOFFS

The MAPP system must be able to survive rough handling and shipping into a chaotic environment, as well as outside weather conditions for the duration of its use. The inverter and output enclosures are constructed from Pelican 1550 weatherproof and ruggedized multipurpose cases modified with holes to attach the electronics backplanes and a large side section cut out to mount the connector boss. All screw holes were sealed with silicon washers, the connector boss is caulked under the mounting flange to the case, and all electronic connectors are watertight when properly closed and capped, and weather-resistant when uncapped in use. The connector boss was 3D printed at 100% infill (solid plastic with no honeycombing) from ABS and protects the connectors from external impact.

Most electronics are mounted to the 18-gauge sheet metal backplanes in the bottom of the case, with user-interfacing switches and circuit breakers on the laser-cut acrylic top covers. The back planes are isolated from the case by rubber mounts to minimize electrical and mechanical shocks from short circuits on the back pane and impact. The step-down transformer (the largest and heaviest component in the assembly at 4" x 4" x 4" and 8 lbs) is in the electronics box and shimmed on the back plane by 0.125" of 50A durometer rubber sheeting for additional mechanical shock isolation and to improve heat rejection from the transformer into the back plane. The enphase microinverter in the inverter box is not rated for mechanical shock and vibration and was therefore also shimmed on thick rubber feet.

The following two material choices were made to enable fabrication with the time, budget, and tools available, and should be revisited before the system is fielded. Acrylic was used to make the switch plate, but is vulnerable to crack formation, especially at edges and corners. While all

load-bearing corners received heavy stress-relieving fillets, future system designs should use impact resistant plastic such as polycarbonate or stamped and painted sheet metal for the switch plate instead. The connector boss was 3D printed from solid ABS with heavily filleted corners, but is subject to potential failure from inter-layer cracking and defects created in the printing process. The part is also unpainted and unsealed, potentially allowing water to wick into the inter-layer microcracks at areas of poor thermal fusion, causing swelling of the part and ultimately cracking. A final commercial unit should feature a connector boss integrally molded into the case, or formed as a solid material by injection molding or thermoforming. MAPP prototypes should also be subjected to MIL-810 ruggedization testing before deployment.

A carrying distance of up to 32 feet (10 meters) puts a single-person carry weight restriction for an object with a handle at 37 lbs.<sup>14</sup> As seen in Table 2, the heaviest component (the inverter enclosures at 33.7 lbs) meets this requirement. Any available field-sources batteries may exceed this, but are not required for operation and are therefore not considered here. It is difficult to further reduce system mass as much of the weight is the Pelican cases which are extremely durable and useful for the system. While it may be possible to allow for a smaller Pelican case by further minimizing electronics through tighter packing or moving to an integrated circuit board, this will make field repairs much more difficult or impossible. Removing the step-down transformer will be possible if Enphase releases a 120V version of the inverter. Lighter solar panels, such as CIGS (Copper-Indium-Gallium-Diselenide) panels or flexible amorphous silicon (aSi) panels, could reduce weight at the cost of lower system efficiency (5-10% less efficiency, requiring a 25% larger ground area) and a tremendous (2-10X) cost increase. Finally, cables could be shortened or another case could be added to carry additional cabling and reduce the average weight of each enclosure but either of these would complicate logistics.

---

<sup>14</sup>According to MIL-STD-1472G; Table TABLE XXXVIII and section 5.8.6.3.7 for both men and women.

**TABLE 2**  
**MAPP Component Weight**

<b>Component</b>	<b>Weight [lb]</b>
Pelican 1550 Case	10.6
Step-down transformer	8.5
Enphase Microinverter	2.2
Sheet metal backplane	1.3
Mounting hardware and wiring	6.3
Interconnecting cables	4.8
<b>Inverter Enclosure Total</b>	<b>33.7</b>
<b>Solar Panels</b>	<b>19.0 (per 4)</b>
Pelican 1550 Case	10.6
Circuit protection, mounting and wiring	6.6
Interconnecting Cables	4.4
<b>Output Enclosure Total</b>	<b>21.6</b>

### 3.8 SYSTEM TESTING

The intent of MAPP going into year 2 was to field a system and get as much hands on use and user feedback as possible. Unfortunately with the redesign effort and new architecture, significant field testing was no longer an option. Therefore, the bulk of system run time was a series of basic function tests to understand how the prototype inverter operated in off-grid mode, to verify the architecture, and to optimize output enclosure configurations.

#### 3.8.1 Microinverter Off-grid Operation Testing

The initial microinverter testing in off-grid mode was done with four PV panels for a total nameplate capacity of 480 Watts, run into a resistor on the output at 240 VAC. One of the behaviors observed during this testing was the droop behavior of the microinverter as shown in Figure 19. This shows the start-up behavior of the inverter as the AC voltage (blue) ramps up along with the current through a load resistor (orange), while the DC voltage from the PV panel (green) dips, and the inverter DC current from the panels increases (red), followed by the load being stepped off. Figure 20 shows the same setup, with periodic PV shading where the AC voltage level rises and falls in response to the PV voltage dips. Figure 21 shows the output load being stepped on, with some control loop oscillations before settling.

#### 3.8.2 Battery Inverter

Building off the PV inverter test setup, a second inverter was added to operate as a bi-directional inverter to charge and discharge a battery. Three 12V lead acid batteries were installed in series to the PV microinverter input, and the AC output of both inverters were tied to the load

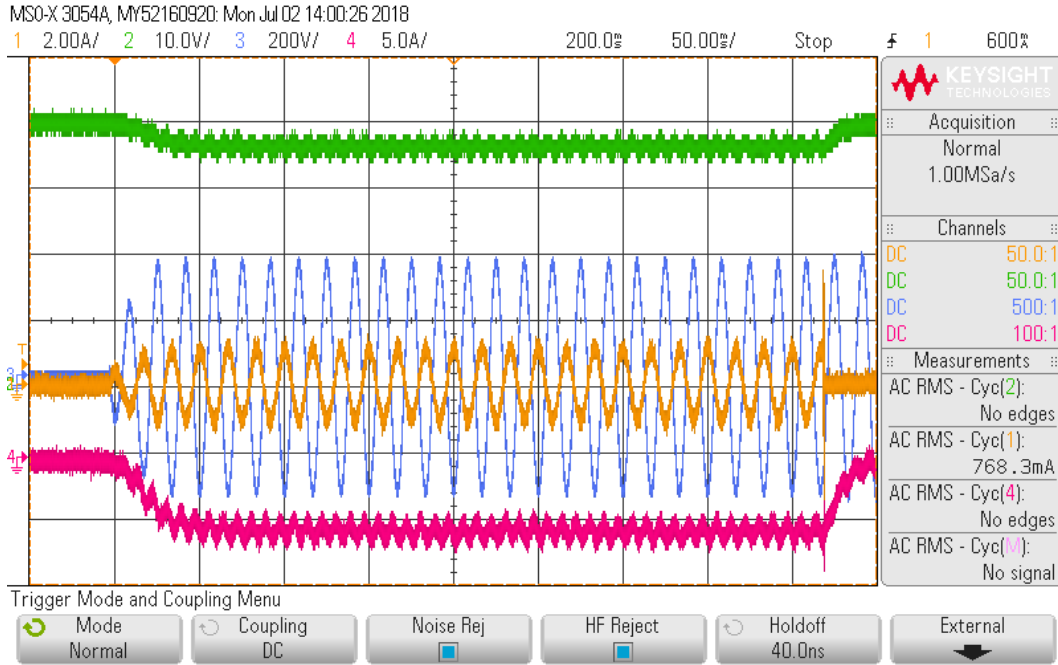

Figure 19. Micronverter power on, and load step off.

while switching from PV being used to charge the battery to PV sourcing power for the load. Figure 22 shows the AC voltage (blue) and the battery voltage (green) remain steady while the battery current (red) drops off when the load current (orange) is applied. The same test setup is used in Figure 23 where the load is being supported by the PV and battery when the load is removed in two steps, and the battery goes from discharging to charging.

### 3.8.3 Thermal Testing

The system enclosures were left outdoors in the sun on asphalt in the middle of the hottest day of the year in MA, where the temperature recorded at the nearby airport reached 36°C during testing. Temperature rise inside of the enclosure reached a maximum of 46°C (10°C above ambient) due to solar loading on the plastic enclosure and conduction from the ground (Figure 24). During this time, the system was unpowered and not generating heat internally due to electrical losses (primarily from the transformer) estimated at 25 Watts. Separate lab testing confirmed a temperature rise of 17°C due to this electrical heating (Figure 25). As the maximum system temperature is limited to 65°C by the Enphase microinverter, the expected cumulative temperature increase of

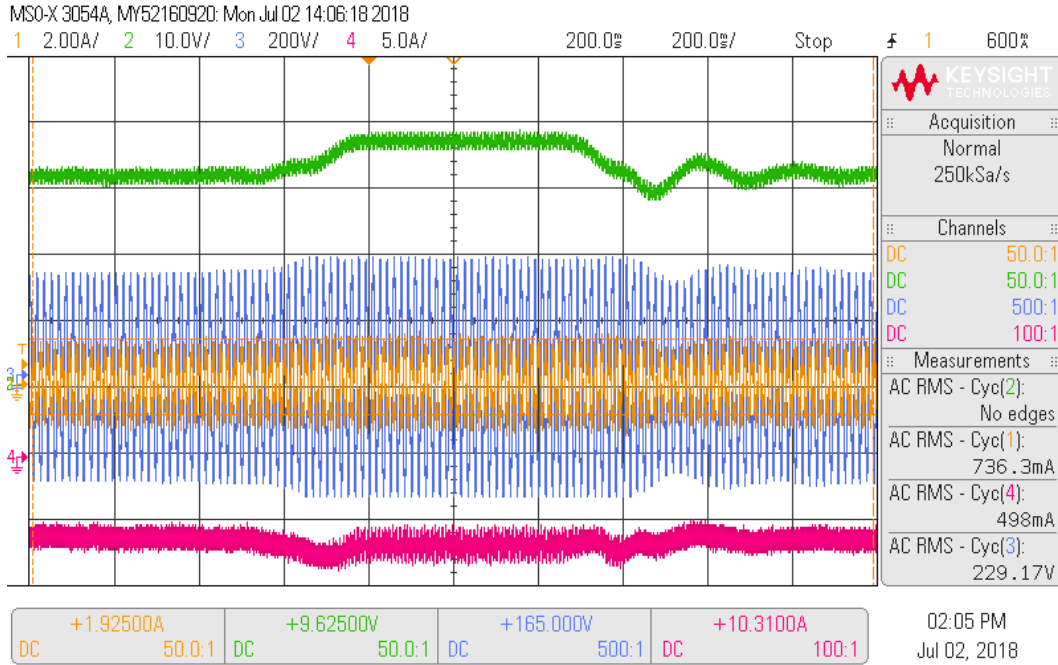

Figure 20. Shading of PV and droop response.

27°C is believed to be sufficient for operation in most environments. Excessive temperature rise leading to system shutdown may occur in hotter climates, but can be mitigated by lifting the enclosure off of the ground at the corners (propped up with rocks for instance) to increase airflow and reduce ground-conducted heat addition, standing the case on edge with the handle up to minimize exposed area to top-down sunlight and maximize airflow over the large sides, or by placing the enclosure in a shaded area.

### 3.8.4 Full System Operation

Full system tests were largely based on gaining experience and run time with the MAPP system. As part of this, components were set up by three different individuals with only minimum direction and no documentation. In all three cases, the system was set up in a configuration that worked, although each was slightly different with respect to layout, cable use and order of setup. Longer run tests included powering lightbulbs, fans, rice cookers and a constant power water filter. In each scenario, loads were applied and removed, cloud cover caused brownouts and load drops. Running tests of these nature showed a noticeable improvement when a battery inverter was added



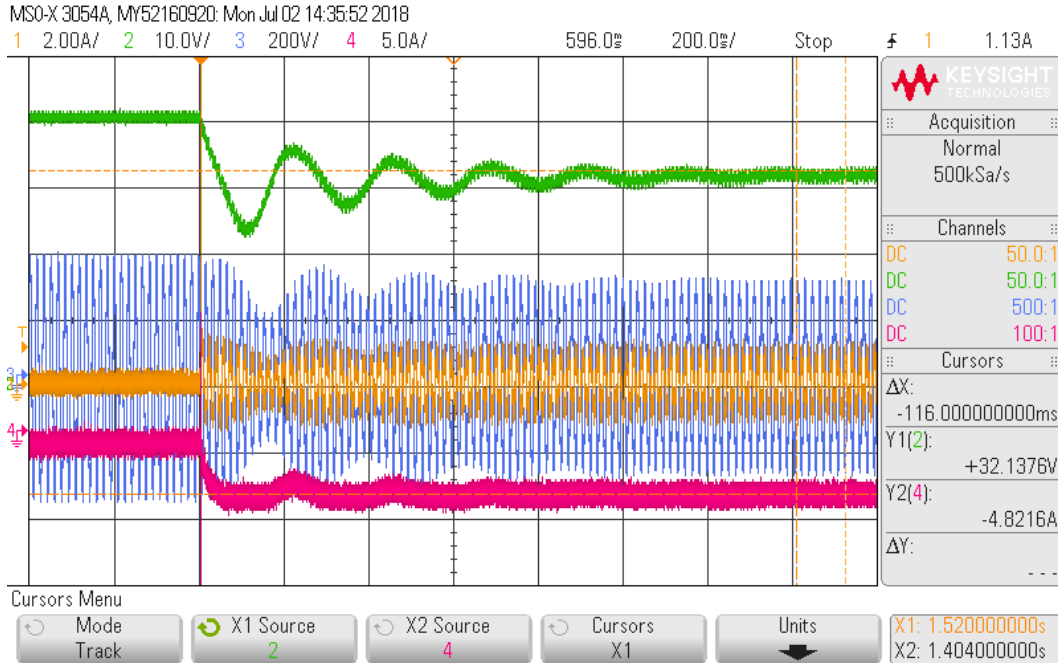

Figure 21. Load step response.

to the system. As examples of some of these modes, Figure 26 shows the current and power flow within the system with a battery when the solar panels were artificially shaded, eventually causing a load drop and recovery. Figure 27 demonstrates operation with a constant power load, dropping the load and the transition in the battery from discharging to charging. The results of these tests lead to several of the items outlined in future work; some to see how the system extends, and more to re-evaluate system performance with production hardware and firmware from Enphase.

### 3.8.5 Inverter Failure

Before voltage control and a multifunction relay was added to the output enclosure, intermittent cloud cover reduced the available solar energy, causing the inverters to shutdown. After multiple automatic restarts, the power output would not recover and troubleshooting revealed three damaged microinverters, which were returned to Enphase (along with one prior failure) for failure analysis. Enphase completed the analysis and shared some details with MIT LL but the root cause fell under the protection of the NDA and is therefore not included here. This fault is expected to be eliminated by hardware and firmware fixes planned for the production units.

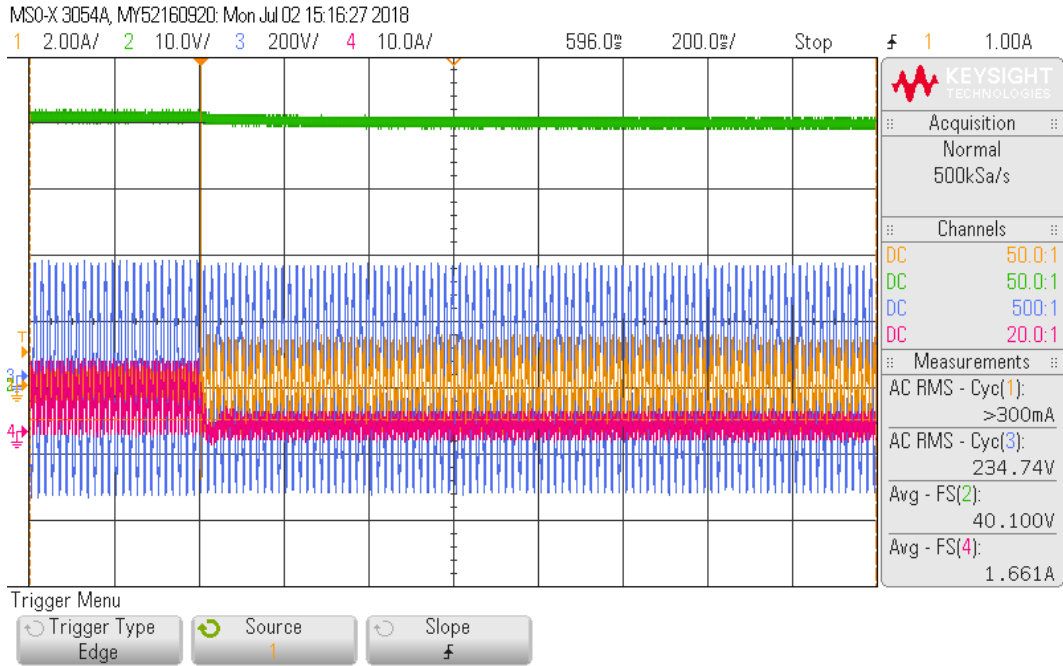

Figure 22. Battery charging followed by applied load.



Figure 23. Battery supporting the load followed by load being removed and battery charging.

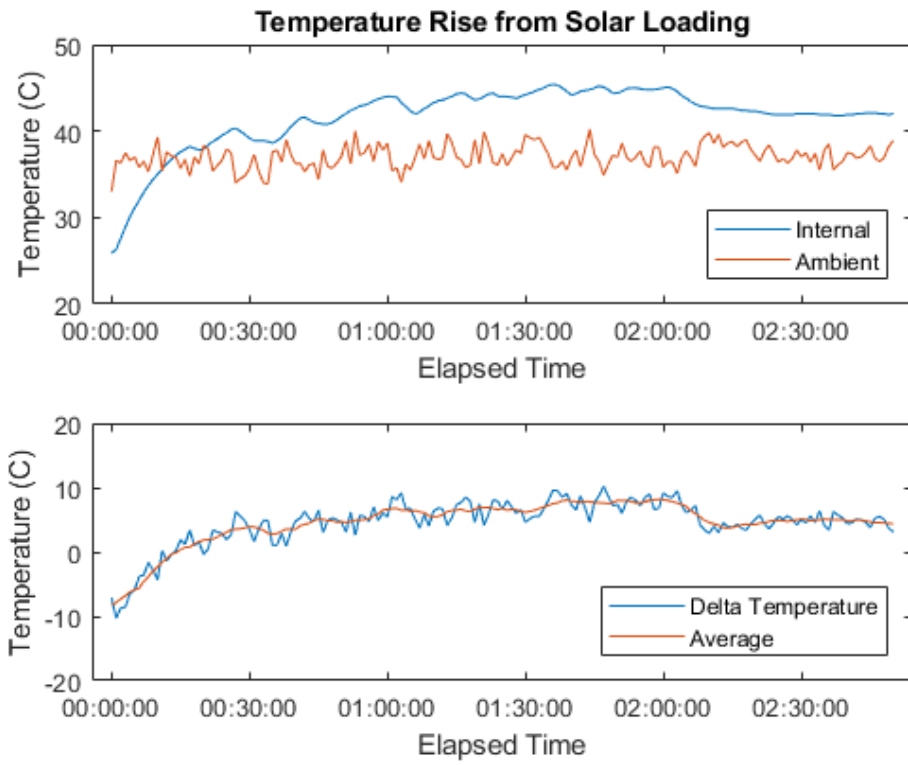

Figure 24. Solar loading temperature testing.

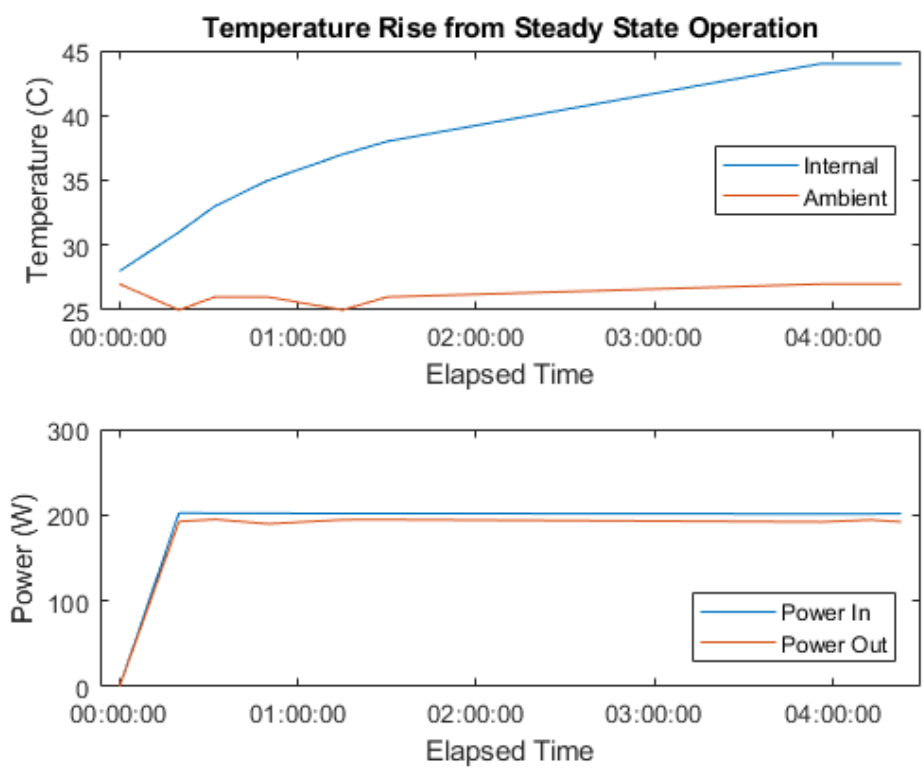

Figure 25. Steady-state temperature testing.

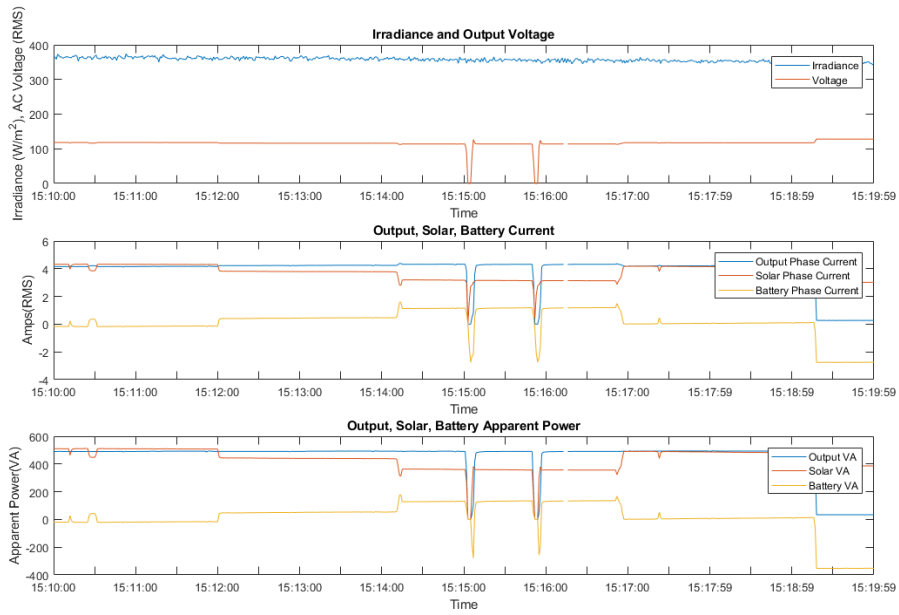

Figure 26. Artificial PV shading with load drop and recovery.

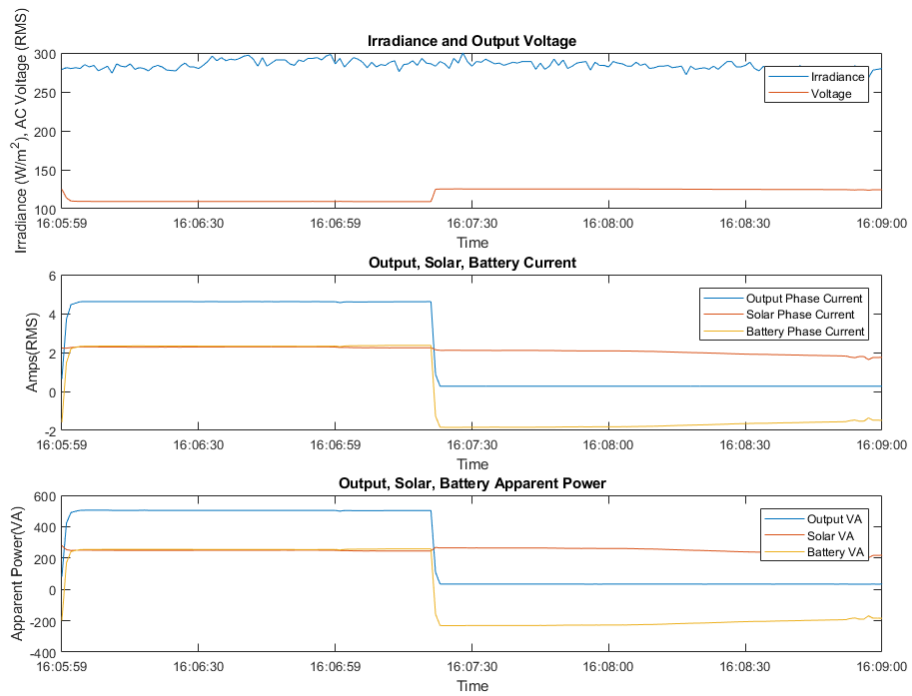

Figure 27. PV testing with battery; load step off, battery goes from discharge to charge.

## 4. FUTURE WORK

With the current iteration of MAPP, the most valuable future work would be in gaining additional run time with real world loads. In test we utilized loads that were very low risk if the power quality was low, or for intermittent sunlight, but since there was no operational benchmark to meet, there was no metric for whether the power quality or feature set was acceptable. Putting the MAPP system into the hands of an end user and learning from their experience would inform future iterations more than static testing of the power outputs. Within MIT LL there have been several possible test loads including cooking with rice cookers, power support for field test sites and for PV off-grid test scenarios. Building additional modules and increasing the total power capacity would increase the size and complexity of potential loads, and would allow determining some better constraints for minimum number of modules needed for differing load and solar conditions.

To further the functional capabilities of MAPP, moving to the production inverters from Enphase would increase the reliability of the system by including the hardware and firmware updates that are currently being tested. The addition of the gateway features could enable some field reconfiguration, or at least manufacturing support for battery parameters or under current power off functions. There is however some risk that the introduction of the gateway could cripple the off-grid capabilities by requiring a gateway for any inverter to turn on in order to meet anti-islanding requirements that MAPP relies on being absent. Enphase has also acknowledged that building a custom or semi-custom inverter would be possible, but the production volume would have to be high enough for it to make financial sense to them. Some of these changes might include different connectors or lower output voltage to eliminate the transformer. Inclusion of a custom higher-efficiency and lower-weight transformer will be studied should continued inclusion of the transformer be necessary. With a transformer evaluation, the system could benefit from a design review targeted at design for manufacturability. This would allow the cost to be lowered for future builds. Components like the acrylic covers and the 3D printed housing would both be likely to be cheaper even in a low volume production. Further research and possible custom PV panels could simplify the input panels or make them easier to transport. There are ruggedized panels available but they have a significant weight and cost trade off. More power could be achieved with some form of racking for the PV to improve the angle of incidence for the irradiance.

This page intentionally left blank.



## APPENDIX A VENDOR RESEARCH

**TABLE A.3**

**Summary of vendor solutions for MAPP**

<b>Vendor</b>	<b>Description</b>	<b>Comments</b>
SolarStik	Tailored AC/DC modular system	Viable option for MAPP phase 1 requirements used DC interconnection
Zero Base	Tailored AC/DC modular system	Provided proposal for MAPP phase 1 Did not meet distributed requirements
Darfon	Microinverter product line	No off-grid option (discontinued and never sold in U.S.)
Enphase	Microinverter product line	Prototyping off-grid mode microinverter does not need a battery Could be used as bi-directional with battery 240 VAC output Very early prototype stage based on existing production product
Chilicon	Microinverter product line	Microinverters possible to work off-grid with use of batteries Minimum battery undefined and would have to be proven
CyboEnergy	Microinverter like product line	Combined multiple PV panels into single output (i.e., 4 microinverters in single package) Off-grid possible without battery Allowed battery input to PV required inverter master in the system. could only expand to 2 inverters 120VAC output
Staubli Power Blox	COTS modular off-grid system	Battery based power and PV 50 Hz output frequency grid or generator rechargeable 230 VAC output voltage No U.S. output connector
Goal Zero Yeti	COTS battery and inverter	300 Watt AC power PV recharge is slow energy can be extended power cannot be increased
Solpad	COTS battery and inverter	600 Wh battery, 72 Watt PV Advertised as being able to expand AC interconnect Not currently available Unclear if was ever available for purchase
Solantro	IC manufacturer	IC and reference sets for microinverters with off-grid demonstrations would require building in house microinverter Reference designs required batteries and based on a central distribution architecture

This page intentionally left blank.

## APPENDIX B ENPHASE SPECIFICATIONS

### Enphase IQ 7 and IQ 7+ Microinverters

INPUT DATA (DC)	IQ7-60-2-US / IQ7-60-B-US		IQ7PLUS-72-2-US / IQ7PLUS-72-B-US	
Commonly used module pairings <sup>1</sup>	235 W - 350 W +		235 W - 440 W +	
Module compatibility	60-cell PV modules only		60-cell and 72-cell PV modules	
Maximum input DC voltage	48 V		60 V	
Peak power tracking voltage	27 V - 37 V		27 V - 45 V	
Operating range	16 V - 48 V		16 V - 60 V	
Min/Max start voltage	22 V / 48 V		22 V / 60 V	
Max DC short circuit current (module Isc)	15 A		15 A	
Overvoltage class DC port	II		II	
DC port backfeed current	0 A		0 A	
PV array configuration	1 x 1 ungrounded array; No additional DC side protection required; AC side protection requires max 20A per branch circuit			
OUTPUT DATA (AC)	IQ 7 Microinverter		IQ 7+ Microinverter	
Peak output power	250 VA		295 VA	
Maximum continuous output power	240 VA		290 VA	
Nominal (L-L) voltage/range <sup>2</sup>	240 V / 211-264 V	208 V / 183-229 V	240 V / 211-264 V	208 V / 183-229 V
Maximum continuous output current	1.0 A (240 V)	1.15 A (208 V)	1.21 A (240 V)	1.39 A (208 V)
Nominal frequency	60 Hz		60 Hz	
Extended frequency range	47 - 68 Hz		47 - 68 Hz	
AC short circuit fault current over 3 cycles	5.8 Arms		5.8 Arms	
Maximum units per 20 A (L-L) branch circuit <sup>3</sup>	16 (240 VAC)	13 (208 VAC)	13 (240 VAC)	11 (208 VAC)
Overvoltage class AC port	III		III	
AC port backfeed current	0 A		0 A	
Power factor setting	1.0		1.0	
Power factor (adjustable)	0.7 leading ... 0.7 lagging		0.7 leading ... 0.7 lagging	
EFFICIENCY	@240 V	@208 V	@240 V	@208 V
Peak CEC efficiency	97.6 %	97.6 %	97.5 %	97.3 %
CEC weighted efficiency	97.0 %	97.0 %	97.0 %	97.0 %
MECHANICAL DATA				
Ambient temperature range	-40°C to +65°C			
Relative humidity range	4% to 100% (condensing)			
Connector type (IQ7-60-2-US & IQ7PLUS-72-2-US)	MC4 (or Amphenol H4 UTX with additional Q-DCC-5 adapter)			
Connector type (IQ7-60-B-US & IQ7PLUS-72-B-US)	Friends PV2 (MC4 intermateable). Adaptors for modules with MC4 or UTX connectors: - PV2 to MC4: order ECA-S20-S22 - PV2 to UTX: order ECA-S20-S25			
Dimensions (WxHxD)	212 mm x 175 mm x 30.2 mm (without bracket)			
Weight	1.08 kg (2.38 lbs)			
Cooling	Natural convection - No fans			
Approved for wet locations	Yes			
Pollution degree	PD3			
Enclosure	Class II double-insulated, corrosion resistant polymeric enclosure			
Environmental category / UV exposure rating	NEMA Type 6 / outdoor			
FEATURES				
Communication	Power Line Communication (PLC)			
Monitoring	Enlighten Manager and MyEnlighten monitoring options. Both options require installation of an Enphase IQ Envoy.			
Disconnecting means	The AC and DC connectors have been evaluated and approved by UL for use as the load-break disconnect required by NEC 690.			
Compliance	CA Rule 21 (UL 1741-SA) UL 62109-1, UL1741/IEEE1547, FCC Part 15 Class B, ICES-0003 Class B, CAN/CSA-C22.2 NO. 107.1-01 This product is UL Listed as PV Rapid Shut Down Equipment and conforms with NEC-2014 and NEC-2017 section 690.12 and C22.1-2015 Rule 64-218 Rapid Shutdown of PV Systems, for AC and DC conductors, when installed according manufacturer's instructions.			

This page intentionally left blank.

# APPENDIX C INVERTER ENCLOSURE SCHEMATIC

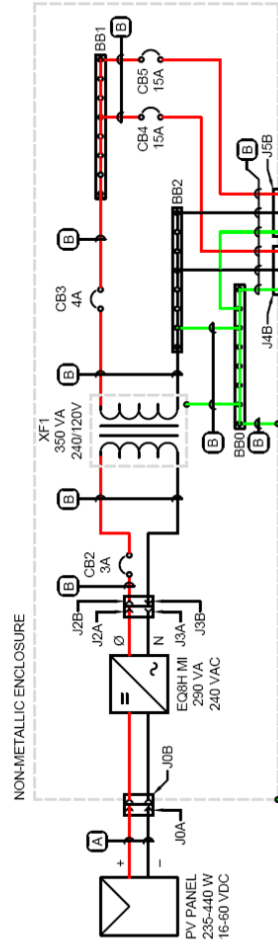

This page intentionally left blank.

# APPENDIX D OUTPUT ENCLOSURE SCHEMATIC

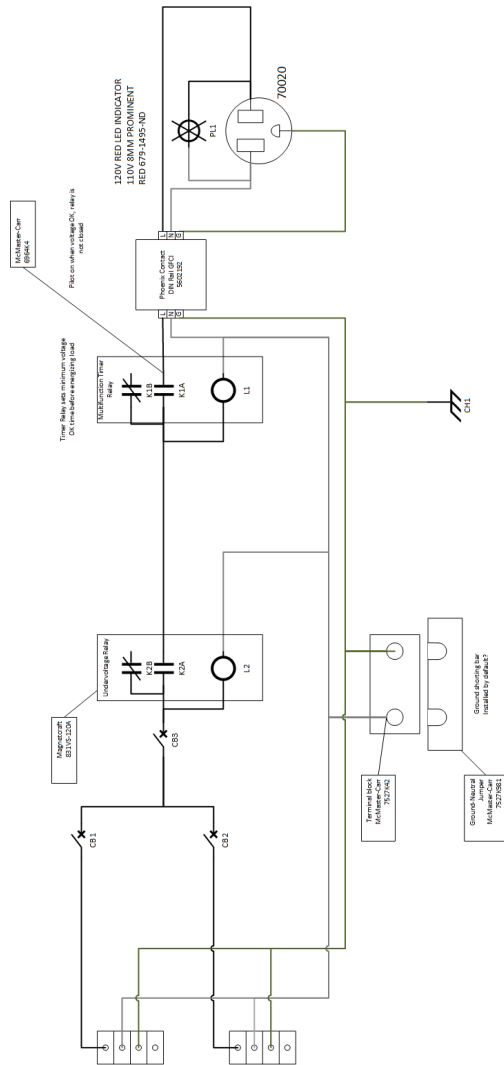

This page intentionally left blank.